



Crossing and Encroachment Guide and Requirements – Canada

Document Owner:	S&R Manager of Damage Prevention, S&R Lands & ROW
Revision Date:	October 4, 2023

Crossing and Encroachment Guide and Requirements – Canada



Table of Contents

1	Introduction.....	1
2	Crossing and Encroachment Activities – What You Need to Know	1
2.1	Activities Requiring Consent	1
2.2	Non-Crossing or Encroachment Activities that Require Consent.....	2
2.3	Early Consultation with Enbridge for Larger Projects	2
2.4	Regulatory Requirements	3
2.4.1	Laws and Regulations	3
2.4.2	Federal and Provincial Regulators	3
2.4.3	Activities Requiring Written Consent.....	3
2.4.3.1	Canada Energy Regulator Regulated Pipelines	3
2.4.3.2	Alberta Energy Regulator Regulated Pipelines	3
2.4.4	Activities Permitted Without Consent	3
2.4.4.1	Canada Energy Regulator Regulated Pipelines	3
2.4.4.2	Alberta Energy Regulator Regulated Pipelines	4
2.4.5	Notification Requirements.....	4
3	Applying for Consent	5
3.1	Ways of Applying for Written Consent	5
3.1.1	Crossing and Encroachment Application and Consent.....	5
3.1.2	Crossing and Encroachment On-Site Application and Consent	5
3.2	Petition of Regulators for Approval	6
3.2.1	Canada Energy Regulator Board Approval.....	6
3.2.2	Alberta Energy Regulator Approval	6
3.3	Drawing Requirements	6
3.3.1	Drawing Requirements for Permanent Installations	6
3.3.2	Drawing Requirements for Temporary Activities	9
3.3.3	Typical Crossing Drawings.....	11
3.4	Application Submission	19
3.5	Application Review and Written Consent	20
4	Requirements Before Construction – One-Call Centres and Locate Requests	20
4.1	One-Call Centres	20
4.2	One-Call Locate Requests.....	20
5	Requirements During Construction.....	21
5.1	General Requirements	21
5.1.1	Fully Executed Consent on Site.....	21
5.1.2	Stop Work	21
5.1.3	Accidental Contact with Enbridge Facilities.....	21
5.1.4	Securing Unattended Open Excavations.....	21
5.1.5	Protection of Enbridge Signage and Test Stations.....	21

Crossing and Encroachment Guide and Requirements – Canada



5.2	Locate and Identify Subsurface Facilities	21
5.2.1	Positive Identification of Enbridge Facilities	21
5.2.2	Vacuum Excavating Requirements	22
5.2.3	Enbridge Inspection of Exposed Pipeline	23
5.3	Excavating	23
5.3.1	Excavation Plan	23
5.3.2	Excavation Requirements	23
5.4	Augering and Pile Driving Requirements	23
5.5	Material Storage Requirements	24
5.6	Lifting Loads Over Enbridge Facilities	24
5.7	Temporary Protective Structures	24
5.7.1	Temporary Protective Structure Designs	24
5.7.2	Adjacent Structure or Foundation Protection	24
5.7.3	Shoring and Trench Boxes	24
5.7.4	Temporary Crossing Ramps and Air Bridges	25
5.7.4.1	When Ramps and Air Bridges are not Required	25
5.7.4.2	Temporary Crossing Ramps	25
5.7.4.3	Air Bridge Requirements	26
5.8	Backfilling and Compaction Requirements	26
5.9	Subsurface Installations	27
5.9.1	Subsurface Installation Requirements	27
5.9.2	Open Cut Installations	27
5.9.2.1	Above an Enbridge Facility Requirements	27
5.9.2.2	Below an Enbridge Facility Requirements	28
5.9.3	Boring Subsurface Installation Requirements	28
5.9.3.1	Technical Requirements for Boring	28
5.9.3.2	Boring Operation General Requirements	28
5.9.4	Drainage Tile Crossing Enbridge Pipelines Requirements	29
5.10	Above-Grade Installations	29
5.10.1	General Requirements for Above-Grade Installations	29
5.10.2	Signs, Fence Posts and KP/MP Marker Installations	29
5.10.3	Resurfacing and Re-graveling	30
5.10.4	Ditch Restoration	30
5.10.5	Minor Berms	30
5.10.6	Spreading or Replacing Soil Fill Material	30
5.10.7	Topsoil Stripping/Levelling and Clearing/Grading	30
5.10.8	Ancillary Installation, Above-Ground Installation or Temporary Storage	30
5.10.9	Agricultural Ground Disturbance	31
5.10.10	Vegetation Control	31
5.10.11	Vehicle Crossings – Wheeled and Tracked Vehicles	31

Crossing and Encroachment Guide and Requirements – Canada



5.10.12	Road Crossings.....	32
5.10.13	Railway Crossings	33
5.11	Power and Communication Installations	33
5.11.1	Consent Limitation	33
5.11.2	Overhead Power Less Than 60 kV and Communication Installation	33
5.11.3	Power Line Data Requirements for Transmission Power	34
5.11.3.1	Power Lines More Than 60 kV	34
5.11.3.2	Information Required for Each Transmission Power Line.....	36
5.12	Geophysical – Blasting, Quarrying and Seismic.....	37
5.13	Site Restoration Requirements	37
6	Emergency Situations and Enbridge Emergency Contact Numbers	38
6.1	Notice of Access	38
6.2	Enbridge Definition of Emergency	38
6.3	One-Call Centres	38
6.4	Enbridge Emergency Contact Numbers	38
7	Definitions	39

Crossing and Encroachment Guide and Requirements – Canada



List of Tables

Table 1: Subsurface and Surface Ground Disturbance Activities.....	2
Table 3: Contact Information for Canadian One-Call Centres	20
Table 4: Overhead AC Distribution Power Line Horizontal Clearances for Distribution Pipelines	34
Table 5: High-Voltage AC Power Line Horizontal Clearances from Structures, Grounding and Anchors for Distribution Pipelines	35
Table 6: Enbridge Crude Oil and Liquids Emergency Numbers for Canada	38
Table 7: Enbridge Gas and Midstream Emergency Numbers for Canada.....	38
Table 8: Enbridge Gas Distribution Emergency Numbers for Canada	39
Table 9: Enbridge Renewable Power and Power Transmission Emergency Numbers for Canada.....	39

List of Figures

Figure 1: Ground Disturbance Zone in Canada.....	4
Figure 2: Blasting Assessment Zone	4
Figure 3: Road Crossing – Typical Drawing	11
Figure 4: Facility Crossing – Typical Drawing	12
Figure 5: Test Lead Connection for Steel Pipeline – Typical Drawing.....	12
Figure 6: Railway Crossing – Typical Drawing.....	13
Figure 7: Crossing Ramp – Typical Drawing.....	14
Figure 8: Crossing Ramp with Mats – Typical Drawing.....	15
Figure 9: Air Bridges – Typical Drawing	15
Figure 10: Resurfacing or Re-gravelling – Typical Drawing.....	16
Figure 11: Ditch Restoration – Typical Drawing.....	16
Figure 12: Minor Berms – Typical Drawing.....	16
Figure 13: Above-Ground Installations – Typical Drawing.....	17
Figure 14: Tracked Vehicles – Typical Drawing.....	17
Figure 15: Wheeled Vehicles – Typical Drawing.....	18
Figure 16: Compaction Equipment – Typical Drawing.....	19
Figure 17: Exposure Points for Bends	22

Crossing and Encroachment Guide and Requirements – Canada



Revision History

Date	Rev #	Revised by	Reviewed by	Approved by	Revision Details
October 19, 2021	0			Ken Goulart	Issued
March 2, 2023	1	Ken Goulart		Ken Goulart	Revised
October 4, 2023	1.1	Emily Bridge		Ken Goulart	Revised

1 Introduction

This document is intended to help applicants understand the Enbridge crossing and encroachment application process and related Enbridge requirements, and includes information about:

- what kinds of crossing and encroachment activities on or near Enbridge facilities require consent and the related requirements (see Section 2, [Crossing and Encroachment Activities – What You Need to Know](#))
- information about applying for consent and submitting an application (see Section 3, Applying for Consent)
- contact information for notifying One-Call Centres before construction or work activities begin (see Section 4, Requirements Before Construction – One-Call Centres and Locate Requests)
- key information for during construction and Enbridge requirements (see Section 5, Requirements During Construction)
- information about notifying Enbridge if an emergency occurs (see Section 6, Emergency Situations and Enbridge Emergency Contact Numbers)

Applicants who cannot meet the minimum approved technical requirements outlined in this document may submit alternative proposals to Enbridge for consideration.

2 Crossing and Encroachment Activities – What You Need to Know

2.1 Activities Requiring Consent

To ensure Enbridge pipelines and facilities operate safely, written consent from Enbridge must be obtained before any of the following occur:

- construction or installation of a new facility across, over, on, along or under an Enbridge facility and/or right-of-way
- operation or movement of vehicles, mobile equipment or machinery across an Enbridge right-of-way, outside of the travelled portion of a highway or public road
- use of explosives within 300 m (985 ft) of an Enbridge pipeline right-of-way
- subdivision development across, on, along or over an Enbridge facility and/or right-of-way
- installation of agricultural drainage tile across, on, along or under an Enbridge facility and/or right-of-way

For specific regulatory requirements and obligations, see Section [2.4](#).

Specific crossing and encroachment activities that require consent might include, but are not limited to, those shown in [Table 1](#).

Table 1: Subsurface and Surface Ground Disturbance Activities

Subsurface Activities	
<ul style="list-style-type: none"> Installing pipeline or cable by trenching, drilling, boring or augering (see Section 5.4 for augering and pile driving and Section 5.9.3 for boring) Excavating or digging (see Sections 5.1.4, 5.2 and 5.3) 	<ul style="list-style-type: none"> Subsoiling/deep tilling - cultivation greater than 0.45 m (1.5 ft) (see Section 5.10.9) Using explosives (see Sections 5.12) Installing drainage tile (see Section 5.9.4)
Surface and Aerial Activities	
<ul style="list-style-type: none"> Installing fence posts, bars, rods, pins, anchors or pilings (see Sections 5.10.1 and 5.11.3) Maintaining existing applicant facilities that affect Enbridge assets, land and/or right-of-way Topsoil stripping/levelling and clearing/grading (see Section 5.10.7) Clearing and stump removal, vegetation management and burning (see Section 5.10.10) Installing above-ground installations, such as sheds, above-ground pools and landscaping (see Section 5.10.8) Using an Enbridge easement/right-of-way area for temporary workspace 	<ul style="list-style-type: none"> Ditching work for water management or reprofiling existing ditches (see Section 5.10.4) Constructing a new public or private road, pathway, parking lot or railway, or widening an existing road (see Section 5.10.1) Installing berms or earthworks that alter the existing ground profile (see Section 5.10.5) Installing overhead power lines, wires or cables (see Section 5.11) Regrading a gravel road (see Section 5.10.3) Grinding and milling asphalt or concrete (see Section 5.10.3) Using or traversing the right-of-way for access (see Section 5.10.11) Storing equipment or material, including trailers, boats, bales, wood piles and vehicles on the right-of-way (see Section 5.10.8)

2.2 Non-Crossing or Encroachment Activities that Require Consent

Other activities also require Enbridge consent, and could include such things as:

- using an Enbridge owned road

2.3 Early Consultation with Enbridge for Larger Projects

Enbridge should be consulted early in the design phase regarding proposed subdivisions, road, pipeline and/or utility projects, railroads and municipal landscaping.

Additionally:

- for subdivisions, Enbridge highly recommends that its right-of-way be used as a passive green space or as part of a linear park system
- roads and utilities may be permitted to cross and/or run parallel to the right-of-way
- projects such as pedestrian pathways, gardens, land contouring, shrubbery and tree planting may be permitted if they do not impede Enbridge access along its right-of-way for operational and/or maintenance activities. Enbridge written consent will specify the permitted landscaping requirements.

2.4 Regulatory Requirements

2.4.1 Laws and Regulations

The applicant must ensure that all work associated with its application complies with local, provincial and federal rules, laws and regulations.

2.4.2 Federal and Provincial Regulators

In Canada, Enbridge has pipelines that are regulated by both the federal government and provincial governments. For more information on any of the regulators, visit their respective websites:

- Canada Energy Regulator (CER): www.cer-rec.gc.ca/index-eng.html
- Alberta Energy Regulator (AER): www.aer.ca
- Ontario Energy Board (OEB): www.oeb.ca
- British Columbia Oil and Gas Commission (BC OGC): www.bcogc.ca

2.4.3 Activities Requiring Written Consent

2.4.3.1 Canada Energy Regulator Regulated Pipelines

For Canada Energy Regulator (CER) regulated pipelines, consent is required for any activities listed in Section [2.1](#) that occur within 30 m (100 ft) of a pipeline.

2.4.3.2 Alberta Energy Regulator Regulated Pipelines

For Alberta Energy Regulator (AER) regulated pipelines, written consent is required for activities listed in Section [2.1](#) within the right-of-way, or within 3 m (10 ft) of a pipeline where no right-of-way exists.

2.4.4 Activities Permitted Without Consent

2.4.4.1 Canada Energy Regulator Regulated Pipelines

The Canadian Energy Regulator Pipeline Damage Prevention Regulations – Authorizations provides that persons operating agricultural vehicles or mobile equipment across pipelines may do so in low-risk areas, under certain conditions when:

- the loaded axle weight and tire pressures of the vehicle or mobile equipment are within the manufacturer’s approved limits and operating guidelines
- the point of crossing has not been the subject of a notification from the pipeline company that crossing at that location could impair the pipeline’s safety or security

These conditions apply to vehicles or mobile equipment used for agricultural activities in producing crops and raising animals and includes pasturing and cultivation activities such as tillage, ploughing, disking and harrowing.

Under Section 2 of the *Canadian Energy Regulator Act*, ground disturbance does not include:

- cultivation to a depth of less than 0.45 m (1.5 ft) below the surface of the ground
- any activity to a depth of less than 0.3 m (1 ft) and that does not result in reduction of the depth of earth cover over the pipeline less than that approved at the time of construction

If the CER requirements cannot be met, then an application must be submitted to Enbridge for further review and processing.

2.4.4.2 Alberta Energy Regulator Regulated Pipelines

The *Pipeline Act* provides that persons operating vehicles or equipment used for farming operations; or use of off-highway vehicles (as defined in section 117(a)(iii) to (viii) of the *Traffic Safety Act*) or use of private passenger vehicles less than ¾ ton may temporarily cross over an AER regulated pipeline without further approval from Enbridge.

If the AER requirements cannot be met, then an application must be submitted to Enbridge for further review and processing.

2.4.5 Notification Requirements

In addition to the consent requirements outlined in this document, notification must be provided to Enbridge:

- before ground disturbance activities in the prescribed area (CER) or controlled area (AER) that extends 30 m (100 ft) from each side of the centreline of the pipeline (see Figure 1)
- before use of the prescribed area (CER) or controlled area (AER) for storage or workspace purposes

Figure 1 shows the prescribed and controlled areas (ground disturbance zone) where notification and/or written consent from Enbridge is required as per CER and AER regulations. Figure 2 shows the blasting assessment zone.

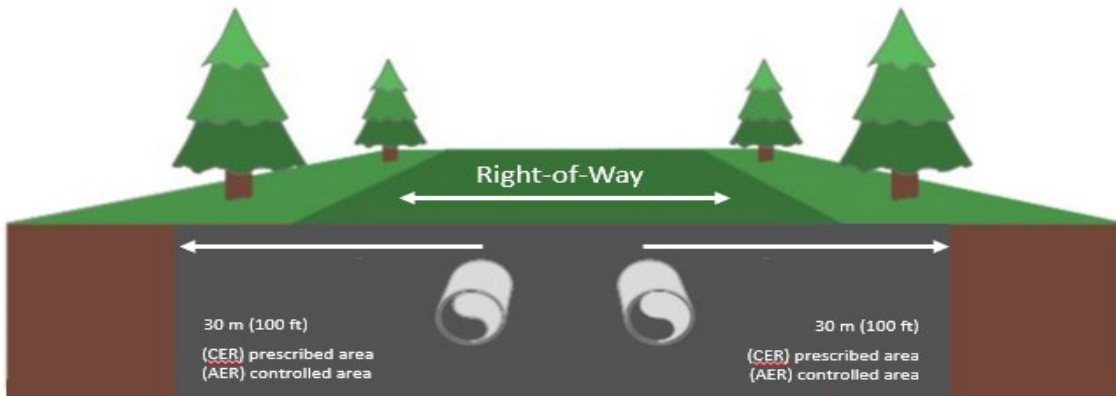

Figure 1: Ground Disturbance Zone in Canada

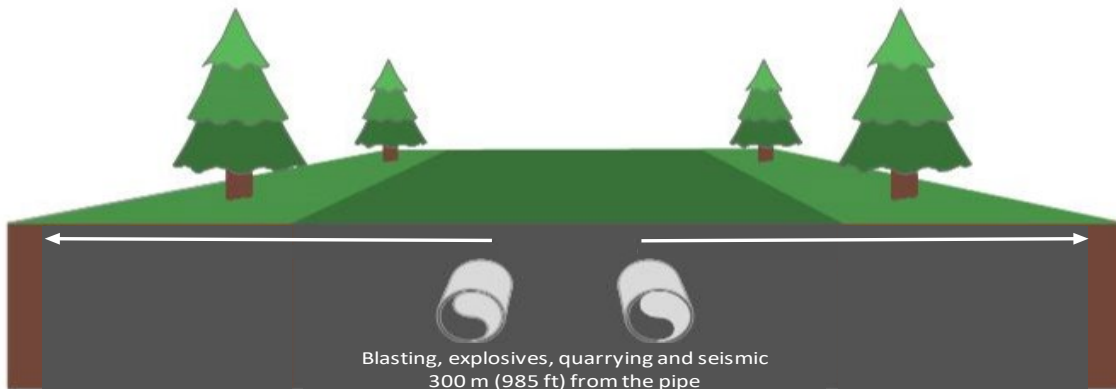

Figure 2: Blasting Assessment Zone

3 Applying for Consent

3.1 Ways of Applying for Written Consent

Written consent from Enbridge must be received before any crossing or encroachment activities begin. The two ways of getting Enbridge consent are either by getting consent:

- from an Enbridge Crossings department (see Section 3.1.1, Crossing and Encroachment Application)
- from an Enbridge Field Representative at a field location (see Section 3.1.2, Crossing and Encroachment On-Site Application)

For CER regulated pipelines, applicants may petition the CER for approval through their appeal process under certain circumstances (see Section [3.2, Petition of Regulators for Approval](#)).

3.1.1 Crossing and Encroachment Application and Consent

The applicant must submit a written request by completing a “Crossing and Encroachment Application,” together with the applicable drawing(s), to the respective Enbridge Crossings department listed in Section [3.4, Application Submission](#). These applications are reviewed and approved through the Enbridge Crossings departments.

The drawing(s) must be prepared in accordance with the minimum standards provided in Section [3.3, Drawing Requirements](#). Enbridge’s vehicle crossing information (see Section [3.3, Drawing Requirements](#)) must also be completed for any vehicle or mobile equipment crossing applications.

Visit enbridge.com/crossings for a copy of the “[Crossing and Encroachment Consent](#),” which includes standard terms and conditions, including but not limited to such things as environmental obligations, liability and indemnity, and insurance requirements.

3.1.2 Crossing and Encroachment On-Site Application and Consent

Certain crossing and encroachment activities might be eligible for approval by an Enbridge Field Representative at a field location. To qualify for consideration of field approval, all proposed activities listed below must meet all the applicable technical requirements outlined in related subsections of Section 5, Requirements During Construction:

- installing some subsurface installations (see Section 5.9.2 and Section 5.9.3):
 - coaxial cable
 - non-metallic pipelines NPS 6 and less
 - fibre optic cable
 - electrical cable less than 750 V
- using air bridges (see Section 5.7.4.3)
- installing drain tile (see Section 5.9.4)
- spreading or replacing soil fill material (see Section [5.10.6](#))
- installing fence posts, KP/MP markers and signage (see Section [5.10.2](#))
- conducting maintenance of roads, pathways and sidewalks (resurfacing or re-gravelling) (see Section [5.10.3](#))
- doing ditch restoration (see Section 5.10.4)
- installing minor berms (see Section 5.10.5)
- installing ancillary or above-ground installations (see Section [5.10.8](#))

- conducting agricultural ground disturbance (see Section [5.10.9](#))
- conducting vegetation control (see Section [5.10.10](#))
- using wheeled and tracked vehicles (see Section [5.10.11](#))
- overhead distribution power and communication lines (see Section [5.11.2](#))

Any proposed on-site activities not meeting the requirements in Section [5, Requirements During Construction](#), must be approved using the “Crossing and Encroachment Application” noted above.

Visit enbridge.com/crossings for a copy of the “[Crossing and Encroachment On-Site Application and Consent](#),” which includes standard terms and conditions, including but not limited to such things as environmental obligations, liability and indemnity, and insurance requirements.

3.2 Petition of Regulators for Approval

3.2.1 Canada Energy Regulator Board Approval

In Canada, for federally regulated pipelines, the applicant may petition the CER for approval of construction activity if:

- the applicant cannot comply with the terms and conditions as set out in the company’s written consent
- the applicant feels the terms and conditions in the company’s written consent are excessive; or
- if the company refused to grant approval to the applicant for reasons of pipeline integrity, public safety or company policy

An application can be filed with the Commission by writing to:

Secretary of the Commission
Canada Energy Regulator
Suite 210, 517 – 10th Ave SW
Calgary AB, T2R 0A8
Phone: 1-877-288-8803
Online: www.cer-rec.gc.ca

Applications may be filed with the Commission by mail, courier or facsimile by calling the toll-free number at 1-877-288-8803. Applications can also be uploaded through the CER’s Applications and Filings Portal on the CER website at Home / Applications and Filings / Submit Applications and Regulatory Documents / File under the CER Act / OPR: CER Act – Guide C (<http://www.cer-rec.gc.ca/pplctnflng/sbmt/nbpr-eng.html>).

3.2.2 Alberta Energy Regulator Approval

When there is no pipeline right-of-way, the AER Pipeline Rules Section 58 states that the AER may approve a ground disturbance activity if approval cannot be reasonably obtained from a licensee.

3.3 Drawing Requirements

3.3.1 Drawing Requirements for Permanent Installations

For all permanent crossings, complete a) Drawing Requirements for all Permanent Crossings. Then identify the type of facility being crossed, see b) to f) below, and provide the related information on the drawings.

a) Drawing Requirements for all Permanent Crossings

Items to Include on all Permanent Drawings

- Plan number, including any revision number and the respective date
- North arrow
- Scale
- Legend or properly labelled on the site plan
- Location indicator, including:
 - legal land description
 - property index number (PIN)
 - Lat/Long coordinates in decimal degrees e.g., 58.269856 -112.568967
 - crossing location of each pipeline affected
- Plan view of the whole quarter section or affected area including:
 - lot lines and road limits
 - proposed facilities (including e.g., curbs, footing, guard rails, guy wires, poles and fences) with tie
 - location of cathodic test lead terminals, if known and applicable
- Cross section view and/or profile view including:
 - for surface structures, show the profile along pipeline(s) with the highest elevation
 - for underground facilities, show the profile along the facility
 - property lines and pipeline(s)
 - drill path plans for subsurface installations, including alignment and entry and exit angles
 - unsupported span (m/ft) of Enbridge pipeline for open-cut installations
- Crossing angle
- Crossing location clearly labelled
- Identification of all affected Enbridge facilities and right(s)-of-way, if applicable
- Method of installation (see Section 7, Definitions)
- Minimum clearance from Enbridge facility

Note that other items, e.g., depth of cover or right-of-way(s), might be required as a revision after preliminary drawings are reviewed.

b) Pipe, Cable, Wire or Line

Items to Include on Pipe, Cable, Wire or Line Drawings

- Pipe diameter
- Pipe material
- Product conveyed
- Cathodic protection system (if applicable)
- Cable, wire or line size
- If cable, wire or line is within a conduit, conduit material and size
- Voltage, if cable, wire or line is electric

c) Above-Grade Installations

For example, road, path, parking lot or railway.

Items to Include on Above-Grade Installation Drawings

- Dimensions of road, path or parking lot
- Elevation at ditch
- Elevation at the centre of the road, path or parking lot
- Surface material
- Road, path type or usage
- Changes to right-of-way
- Lat/Long coordinates in decimal degrees e.g., 58.269856 -112.568967 of the beginning and end of the limits of the crossings in the right-of-way
- Maximum excavation/milling/removal of material from above the pipeline

d) Overhead Distribution Power

For transmission power lines, see Section 5.11.3, Power Line Data Requirements for Transmission Power for additional drawing requirements.

Items to Include on all Overhead Distribution Power Drawings

- Pole number(s)
- Location of e.g., pole, guy wire or anchors, with GPS coordinates and distance from Enbridge pipeline
- Method of installation of e.g., pole, guy wire or anchors
- Vertical clearance to ground or grade
- Width of the applicant's right-of-way easement
- Voltage

e) Drainage Tile

Items to Include on Drainage Tile Drawings

- Location of tile (the entry point into the easement, crossing point over the facility and the exit point or the parallel distance from the facility)
- Incremental cost analysis, if applicable
- Tile diameter
- Tile material
- Method of installation

f) Berms or Earthworks that Change the Cover Profile

For example, excavations and ditching.

Items to Include on Berms and Earthworks Drawings

- Dimensions including width, depth or height and length of earth material being installed or removed
- Type of earth or material

3.3.2 Drawing Requirements for Temporary Activities

For all temporary crossings, complete g) Drawing Requirements for all Temporary Activities. Then identify the type of facility being crossed, see h) to n) below, and provide the related information on the drawings.

g) Drawing Requirements for all Temporary Activities

Items to Include on all Drawings for Temporary Activities

- Plan number, including any revision number and the respective date
- North arrow
- Scale
- Legend or properly labelled on a site plan
- Location indicator, including:
 - legal land description
 - PIN
 - GPS coordinates (decimal format)
- Plan view of the whole quarter section or affected area
- Temporary activities (including location) clearly labelled
- Identify all affected Enbridge facilities, right-of-way(s) and/or easement ownership. Enbridge facilities must be field verified.
- Soil type, if known

h) Workspace

Items to Include on Workspace Drawings

- Location
- Measurement of workspace
- Purpose

i) **Blasting – Including Seismic and Geophysical Activities**

Items to Include on Blasting Drawings

- Charge layout (including number of units/lines)
- Type and material specification of source
- Charge weight per hole
- Distance from Enbridge facilities
- Project name and prospect name (Canada, or if applicable)

j) **Access of Right-of-Way**

Items to Include on Access of Right-of-Way Drawings

- Location
- Kilometre or mile usage of right-of-way
- Width of access
- Egress/ingress points
- Complete the vehicle crossing information (see l), m) and n) for wheeled, tracked and compaction requirements below)

k) **Enbridge Owned Road Use**

Items to Include on Enbridge Owned Road Use Drawings

- Indicate road(s) to be used
- Kilometre or mile usage
- Reason required
- Frequency of use
- Complete the vehicle crossing information (see l), m) and n) for wheeled, tracked and compaction requirements below)

l) **Wheeled Vehicles**

Items to Include on Wheeled Vehicle Drawings

Complete all information in the typical drawing section for wheeled vehicles.

- For road legal vehicles, submit a typical drawing including the table, in Section 3.3.3, Typical Crossing Drawings (Figure 15: Wheeled Vehicles – Typical Drawing) for each of the heaviest axle load per grouping by axle configuration, e.g., the heaviest single, heaviest tandem, heaviest tridem vehicle.
- For non-road legal vehicles, submit a typical drawing including the table, in Section 3.3.3, Typical Crossing Drawings (Figure 15: Wheeled Vehicles – Typical Drawing) for each vehicle.

m) **Tracked Vehicles**

Items to Include on Tracked Vehicle Drawings

- Submit a typical drawing including the table in Section 3.3.3, Typical Crossing Drawings (Figure 14: Tracked Vehicles – Typical Drawing) for each tracked vehicle.

n) Compaction Equipment

Items to Include on Compaction Equipment Drawings

- Submit a typical drawing including a table in Section 3.3.3, Typical Crossing Drawings (Figure 16: Compaction Equipment – Typical Drawing) for each piece of compaction equipment.

3.3.3 Typical Crossing Drawings

See below typical drawings for:

- road crossing
- facility crossing
- test lead connection for steel pipeline
- railway crossing
- crossing ramps
- crossing ramp with mats
- air bridges
- resurfacing or re-gravelling
- ditch restoration
- minor berms
- above-ground installations
- wheeled vehicles
- tracked vehicles
- compaction equipment

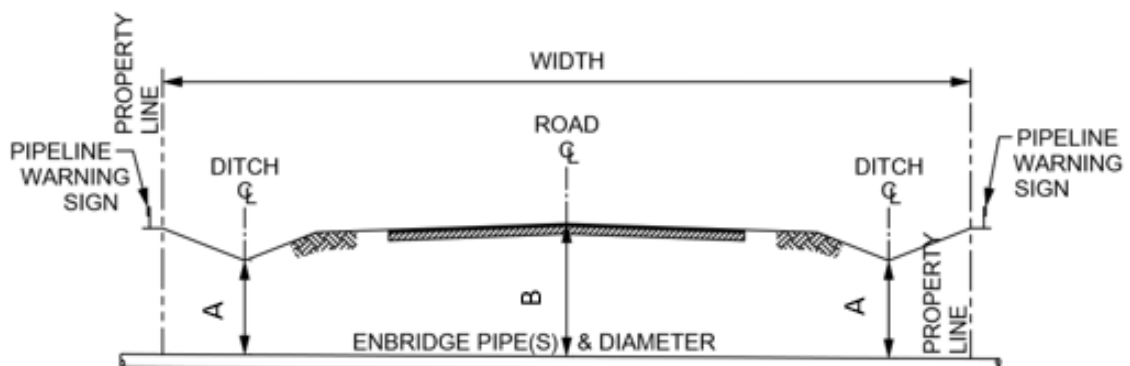

Figure 3: Road Crossing – Typical Drawing

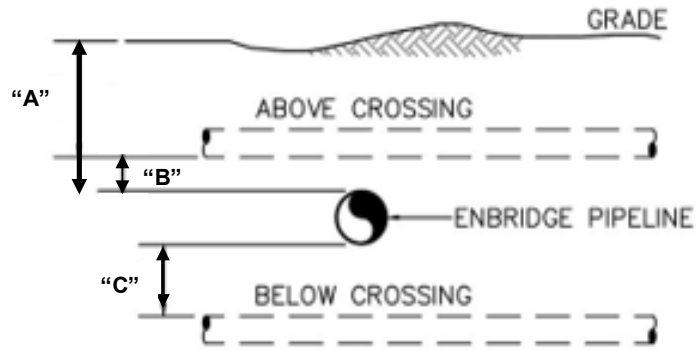

Figure 4: Facility Crossing – Typical Drawing

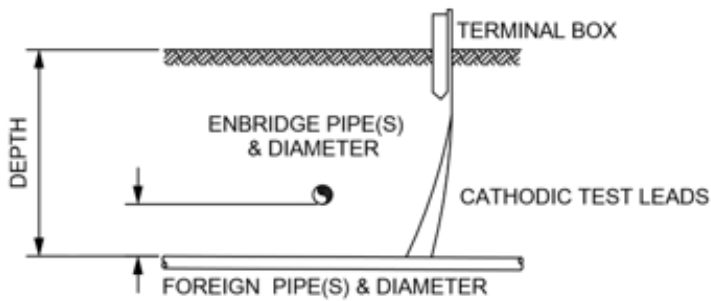
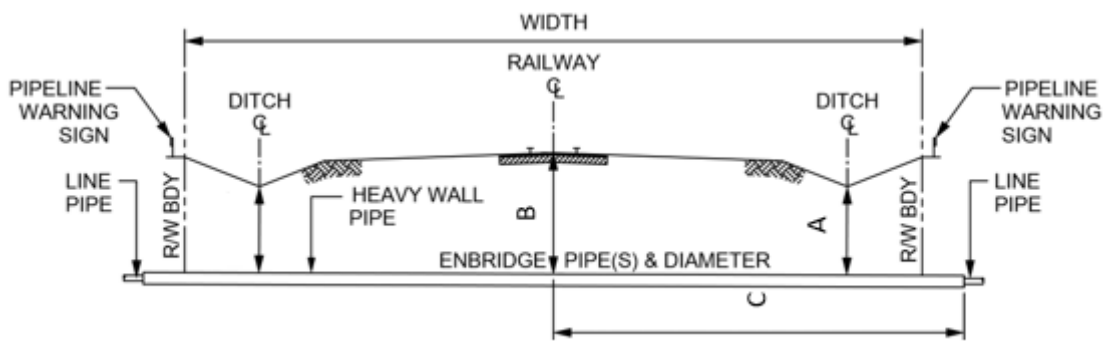
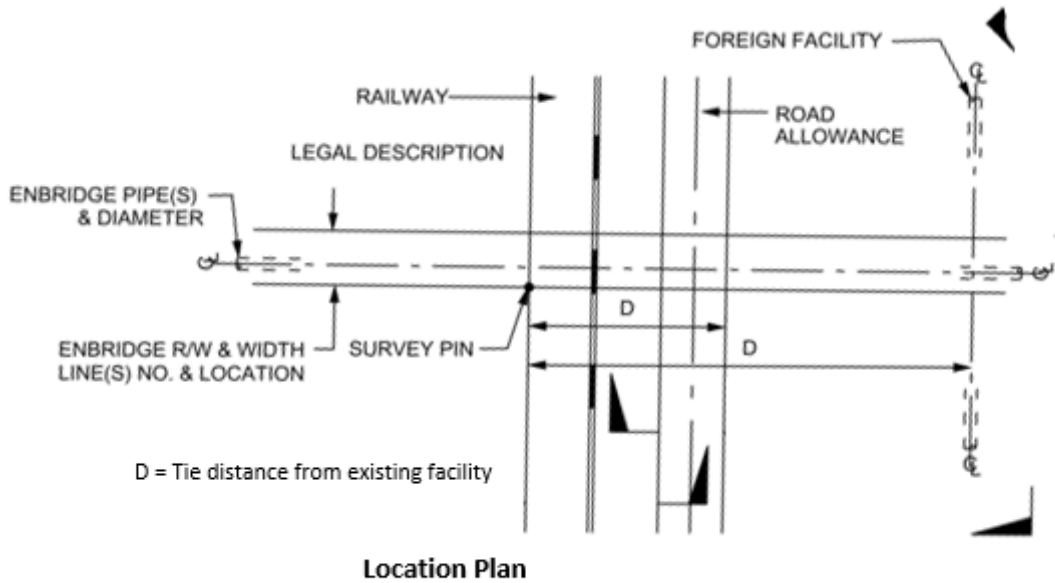

Figure 5: Test Lead Connection for Steel Pipeline – Typical Drawing



Note: Because Enbridge pipelines operate under high pressure, an Enbridge Representative(s) must be present during construction.

Figure 6: Railway Crossing – Typical Drawing

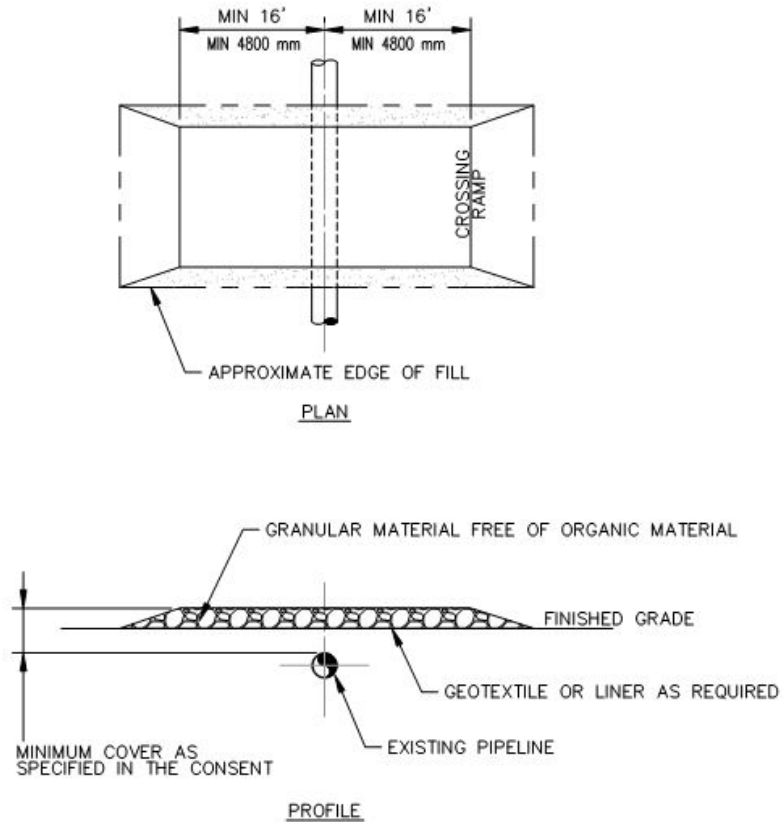

Figure 7: Crossing Ramp – Typical Drawing

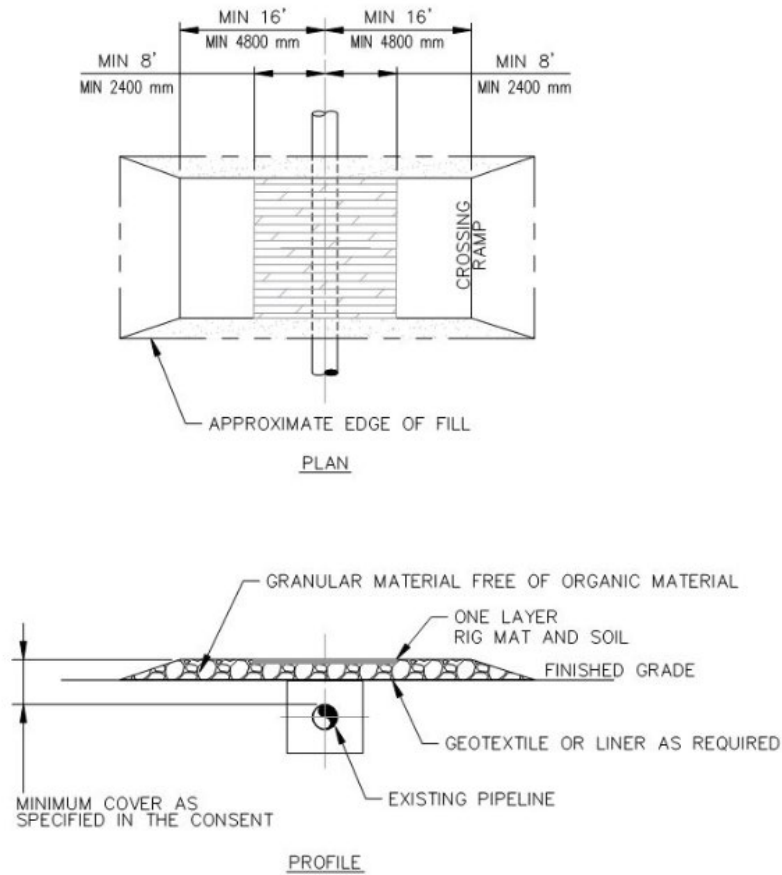

Figure 8: Crossing Ramp with Mats – Typical Drawing

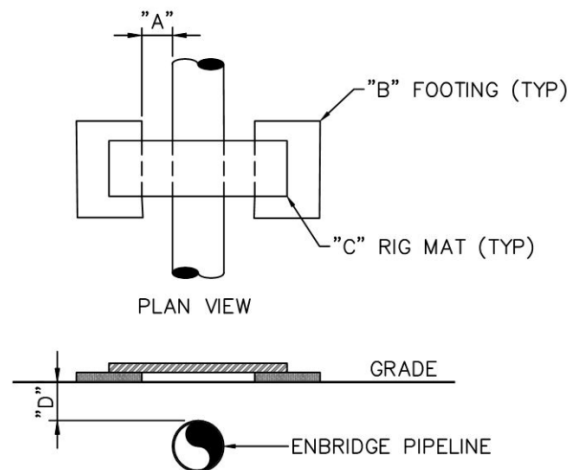
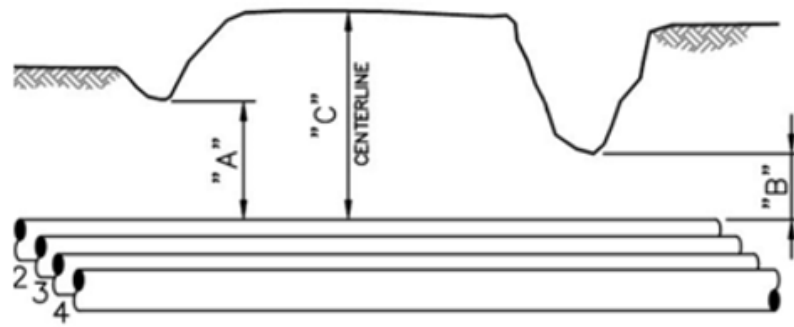

Figure 9: Air Bridges – Typical Drawing



All measures to the top of pipe

Figure 10: Resurfacing or Re-gravelling – Typical Drawing

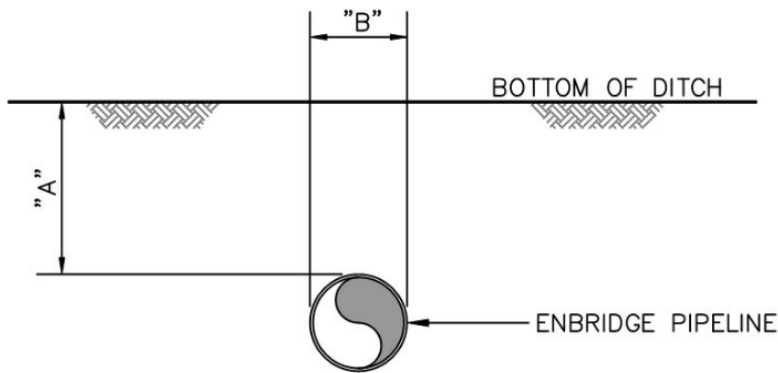

Figure 11: Ditch Restoration – Typical Drawing

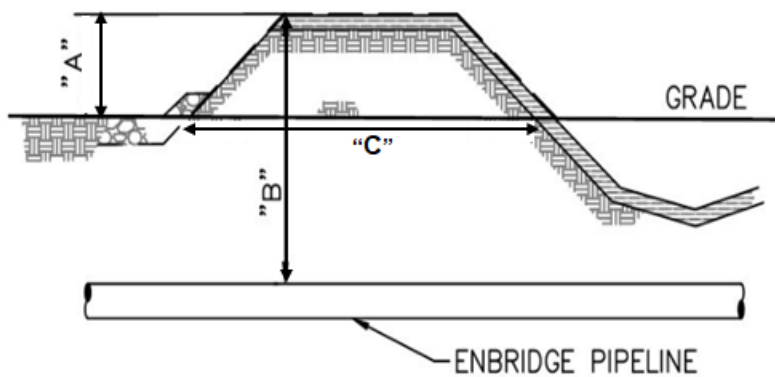

Figure 12: Minor Berms – Typical Drawing

Crossing and Encroachment Guide and Requirements – Canada

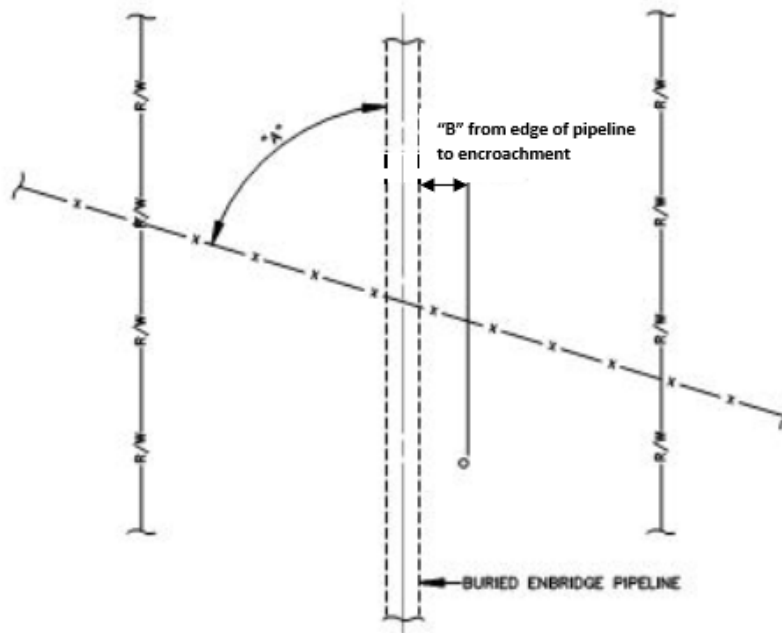
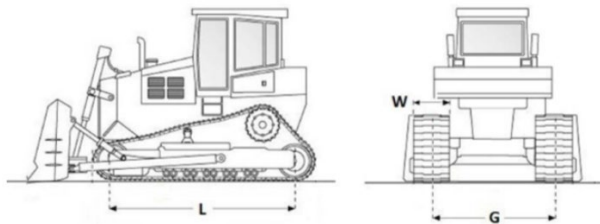

Figure 13: Above-Ground Installations – Typical Drawing



Manufacturer:				Model:			
Equipment description:							
Fully loaded gross vehicle weight:						<input type="checkbox"/> kg <input type="checkbox"/> lb	
Track Shoe Width (see W in figure):		Track Length on Ground (see L in figure):			Track Gauge on Centre (see G in figure):		
Track	<input type="checkbox"/> mm <input type="checkbox"/> in.	<input type="checkbox"/> mm <input type="checkbox"/> in.	<input type="checkbox"/> mm <input type="checkbox"/> in.	<input type="checkbox"/> m <input type="checkbox"/> ft			

Figure 14: Tracked Vehicles – Typical Drawing

Crossing and Encroachment Guide and Requirements – Canada



Road Legal Requirements

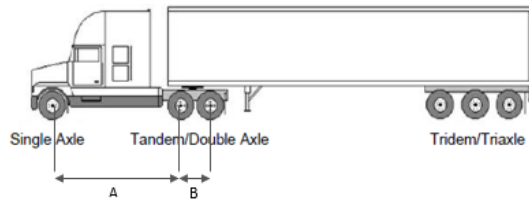

Complete the following table for the heaviest axle load per grouping that is road legal. NOT for non-road legal vehicles or construction equipment.

Non-Road Legal Requirements

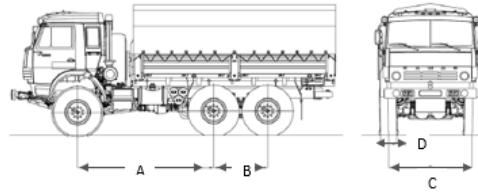

Complete the following table for each vehicle that is not road legal.

Manufacturer:			Model:			
Equipment description:						
Fully loaded gross vehicle weight:			<input type="checkbox"/> kg <input type="checkbox"/> lb			
Axle Grouping	Max. Loaded Weight PER Axle	Number of Tires PER Axle	Individual Tire Width (see D above)	Tire Pressure	Distance between Tire Set Centrelines (see C above)	Centreline Distance to Previous Axle (see A and B above)
Steering	<input type="checkbox"/> kg <input type="checkbox"/> lb		<input type="checkbox"/> mm <input type="checkbox"/> in.		<input type="checkbox"/> mm <input type="checkbox"/> in.	<input type="checkbox"/> mm <input type="checkbox"/> in.
2nd	<input type="checkbox"/> kg <input type="checkbox"/> lb		<input type="checkbox"/> mm <input type="checkbox"/> in.		<input type="checkbox"/> mm <input type="checkbox"/> in.	<input type="checkbox"/> mm <input type="checkbox"/> in.
3rd	<input type="checkbox"/> kg <input type="checkbox"/> lb		<input type="checkbox"/> mm <input type="checkbox"/> in.		<input type="checkbox"/> mm <input type="checkbox"/> in.	<input type="checkbox"/> mm <input type="checkbox"/> in.
4th	<input type="checkbox"/> kg <input type="checkbox"/> lb		<input type="checkbox"/> mm <input type="checkbox"/> in.		<input type="checkbox"/> mm <input type="checkbox"/> in.	<input type="checkbox"/> mm <input type="checkbox"/> in.
5th	<input type="checkbox"/> kg <input type="checkbox"/> lb		<input type="checkbox"/> mm <input type="checkbox"/> in.		<input type="checkbox"/> mm <input type="checkbox"/> in.	<input type="checkbox"/> mm <input type="checkbox"/> in.
6th	<input type="checkbox"/> kg <input type="checkbox"/> lb		<input type="checkbox"/> mm <input type="checkbox"/> in.		<input type="checkbox"/> mm <input type="checkbox"/> in.	<input type="checkbox"/> mm <input type="checkbox"/> in.
7th	<input type="checkbox"/> kg <input type="checkbox"/> lb		<input type="checkbox"/> mm <input type="checkbox"/> in.		<input type="checkbox"/> mm <input type="checkbox"/> in.	<input type="checkbox"/> mm <input type="checkbox"/> in.
Total Axle Weight						

Figure 15: Wheeled Vehicles – Typical Drawing

Crossing and Encroachment Guide and Requirements – Canada



Select or sketch the correct loading diagram							Other (sketch here)
	Manufacturer:		Model:				
Equipment description:							
Dimensions (per circled/selected diagram)							
Drum length:	L=	<input type="checkbox"/> mm <input type="checkbox"/> in.	Drum diameter:	D=	<input type="checkbox"/> mm <input type="checkbox"/> in.		
Wheelbase:	B=	<input type="checkbox"/> mm <input type="checkbox"/> in.	Tire width:	A=	<input type="checkbox"/> mm <input type="checkbox"/> in.		
Gauge (on center):	G=	<input type="checkbox"/> mm <input type="checkbox"/> in.	Tire pressure:		<input type="checkbox"/> psi <input type="checkbox"/> kPa		
Other dimensions from sketch:							
Loading (include units):							
Total operating weight:						<input type="checkbox"/> smooth drums <input type="checkbox"/> padfoot drums	
Static weight on front drum/axle:							
Static weight on rear drum/axle:							
Centrifugal force: high vibration low vibration							

Figure 16: Compaction Equipment – Typical Drawing

3.4 Application Submission

3.4.1 Download and Complete the Application Form

- Save the form to your computer, open it in Adobe to fill out the PDF, save a completed copy and email it to us at crossingsCanada@enbridge.com; or,
- Download and print the form from [our website](#), fill it out, scan, or photograph it and email it to us at crossingsCanada@enbridge.com

3.5 Application Review and Written Consent

After applying for written consent, Enbridge will review the proposed installation(s) and/or temporary activity(ies) application to ensure that the proposed work will not pose a risk to existing Enbridge facilities, and to ensure that any access required to existing facilities for maintenance or in an emergency will not be impeded.

Some applications might require a further engineering assessment that will require additional time to review the proposed installation(s) and/or temporary activity(ies) before Enbridge issues a consent. All efforts will be made to provide a written consent within an appropriate timeframe. Please ensure that your application is complete (refer to other sections of this document for items relevant to your proposed activity) and your application request is submitted with ample lead time.

4 Requirements Before Construction – One-Call Centres and Locate Requests

4.1 One-Call Centres

Call or click before you dig!! Enbridge is a member of Call or Click Before You Dig, a quick, free and easy communication service that notifies member companies of proposed activities so that underground infrastructure can be safely marked with flags, stakes or paint before work begins.

Before putting a shovel in the ground, whether it is in your backyard or a commercial job site, you must submit a locate request to safely identify any underground facilities by contacting your local One-Call Centre as shown below.

Table 2: Contact Information for Canadian One-Call Centres

Region	Telephone	Website
British Columbia	1-800-474-6886	https://www.bc1c.ca/
Alberta	1-800-242-3447	http://albertaonecall.com
Saskatchewan	1-866-828-4888	www.sask1stcall.com
Manitoba	1-800-940-3447	http://www.clickbeforeyoudigmb.com/
Ontario	1-800-400-2255	www.on1call.com
Quebec	1-800-663-9228	www.info-ex.com
New Brunswick	1-866-344-5463	www.info-ex.com
Nova Scotia	1-866-344-5463	www.info-ex.com
Northwest Territories	1-867-587-7000 (toll free)	Not available in the Northwest Territories

4.2 One-Call Locate Requests

Applicants must place a One-Call locate request with the appropriate One-Call Centre and ensure Enbridge has completed a locate before beginning any ground disturbance activity.

In the following situations, a new locate request is required:

- when surface markings become dislodged, removed or unrecognizable
- if the One-Call ticket expires

- if a new contractor or subcontractor is retained to conduct ground disturbance work in the area, as transfer (piggybacking) of existing tickets is **not** permissible
- if there is a change in the scope of work (i.e., change in the excavation area or duration of a project)

Note: Additional locates beyond the locate boundary might be required to verify alignment.

5 Requirements During Construction

5.1 General Requirements

5.1.1 Fully Executed Consent on Site

Applicants must ensure a fully executed copy of the consent is on site during construction and before notice is provided to an Enbridge Representative.

5.1.2 Stop Work

Enbridge Representatives have the authority to stop work at any time due to safety, environmental or operational concerns and/or unforeseen circumstances or emergency situations. For example, Enbridge Representatives can stop work if they:

- have a concern for safety or security of Enbridge assets, the environment and the public
- have concern for pipeline integrity
- are required to leave the work site

The Enbridge Representative will determine when activities can recommence.

5.1.3 Accidental Contact with Enbridge Facilities

Immediately notify an Enbridge Representative if:

- your equipment accidentally comes into contact with an Enbridge facility
- you think your equipment might have contacted an Enbridge facility

Note: Even a small scratch or dent in a pipeline's coating can impact long-term safety of the pipeline and must be assessed by Enbridge. See Section [6](#) for emergency contact information.

5.1.4 Securing Unattended Open Excavations

Unattended open excavations, trenches, potholes and boreholes must be barricaded or fenced off as appropriate, depending on conditions. If any Enbridge facility is left exposed overnight, steel traffic plates and/or an orange safety fence, or an alternative Enbridge-approved method of securing the site, must be used to protect the public, the environment and Enbridge facilities.

5.1.5 Protection of Enbridge Signage and Test Stations

If applicable, all Enbridge signage and test stations must be protected during construction. If any of them need relocation due to construction, this work must be only performed by, or under the supervision of, an Enbridge Representative and at the cost of the applicant.

5.2 Locate and Identify Subsurface Facilities

5.2.1 Positive Identification of Enbridge Facilities

Enbridge requires that all buried facilities are positively located and identified to Enbridge's satisfaction before planned ground disturbance activities occur within 5 m (16 ft) of any Enbridge facility and/or

within the right-of-way. In addition to the One-Call locate request, the applicant must positively identify any Enbridge facility by one or more of the following:

- hand digging
- vacuum excavating (air-vacing or hydro-vacing)

The applicant must ensure that:

- positive identification is to a sufficient width to visually identify (positively identify) the location, direction/alignment, depth, size and type of any Enbridge below-grade facilities
- all bends at a minimum are positively identified at the beginning, centre and end of the bend to ensure that the profile is accurately identified (see [Figure 17](#)) (some bends may require additional exposure holes)
- locations that require more than one exposure hole must not have exposure holes spaced more than 23 m (75 ft) apart (centre-to-centre)

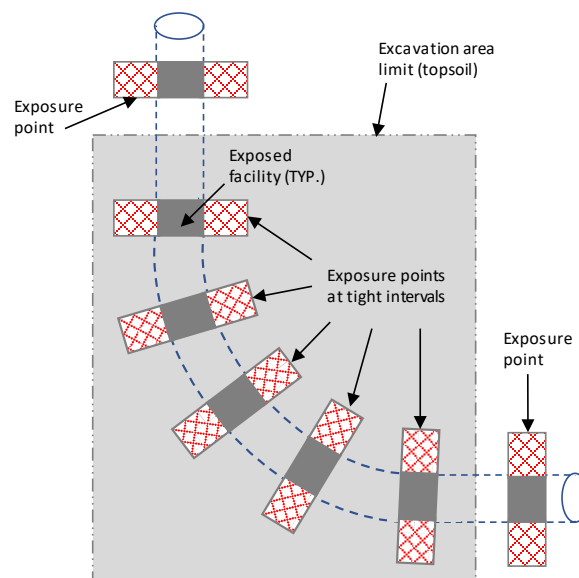

Figure 17: Exposure Points for Bends

5.2.2 Vacuum Excavating Requirements

Vacuum excavating activities contain inherent risks and the appropriate controls must be followed to avoid damage to Enbridge facilities.

For all vacuum excavating activities, the applicant must ensure to:

- use a neoprene or equivalent tip on the vacuum end to eliminate the possibility of damage to the Enbridge facility
- remove any loose rock embedded in the sides of the excavation that could fall on the Enbridge facility when the vacuum excavation activity is complete

For hydro-vacuum excavating (hydro-vac) activities, in addition to the above requirements, the applicant must:

- ensure the working water pressure does not exceed 17,250 kPa (2500 psi)
- reduce pressure to less than 10,350 kPa (1500 psi) and limit water temperature to 38°C (100°F) when excavating within 0.3 m (1 ft) of any Enbridge facility
- ensure the Enbridge facility is not continually contacted by direct spray once it has been sighted or exposed

5.2.3 Enbridge Inspection of Exposed Pipeline

At any location where an Enbridge pipeline is exposed, the applicant must allow Enbridge the opportunity to inspect the condition of the pipeline.

5.3 Excavating

5.3.1 Excavation Plan

An excavation plan must be reviewed and approved by the Enbridge Representative before mechanical excavation can occur. The excavation plan may be a written document or a verbal discussion with the Enbridge Representative. At a minimum, the excavation plan must include, but not be limited to the:

- excavator set-up position in relationship to the Enbridge asset
- need for benching to level the excavator
- required excavation depth and length
- sloping and shoring requirements
- ingress/egress ramp locations
- minimum clearance requirements for mechanical equipment
- pipeline location and depth
- spoil pile location
- compliance with applicable federal and provincial regulations

5.3.2 Excavation Requirements

The use of excavation equipment in the Enbridge right-of-way, or off the right-of-way and within 3 m (10 ft) of an Enbridge pipeline (measured from the centreline of the pipeline), must be evaluated by Enbridge.

For excavations, the applicant must:

- ensure a bar is welded onto backhoe bucket teeth and the side cutters must be removed. In exceptional circumstances where buckets with teeth and dozers with ripper teeth are required, then documented approval by the Enbridge Representative is required.
- **not** in any manner use any Enbridge facility as a platform while excavating
- **not** use mechanical excavation within 0.6 m (2 ft) of any Enbridge facility, including protruding material that extends outside the bucket (e.g., frozen material, rocks or concrete) (1.0 m [3 ft] for CER regulated lines)
- **not** use manually operated jack hammers or hoes equipped with jack hammers directly over any Enbridge facility

5.4 Augering and Pile Driving Requirements

Augering and pile driving activities are not allowed within the right-of-way.

Augering and pile driving outside of the right-of-way, but inside the prescribed areas for CER and AER regulated lines, or within 10 m (33 ft) of any below-grade Enbridge facility requires review and approval by Enbridge.

5.5 Material Storage Requirements

Storage of material, or temporary parking of equipment or vehicles is **not** permitted over any Enbridge right-of-way unless written approval is received from Enbridge.

If soil stockpiles are approved to be placed on the right-of-way, Enbridge requires that stockpiles must:

- be stored at least 1 m (3 ft) from the edge of a working excavation
- not have a spoil pile slope greater than 45 degrees from the horizontal
- be limited to 1.5 m (5 ft) in height
- have a physical barrier, approved by Enbridge, placed on the ground before placing soil on top of it

5.6 Lifting Loads Over Enbridge Facilities

When working in close proximity to any Enbridge facility, the applicant must ensure:

- equipment used for lifting, including cranes, and associated rigging are properly maintained, checked, rated and sized correctly for the intended load
- the equipment is not set up within 3 m (10 ft) of any Enbridge facility
- the outriggers are not set up within 3 m (10 ft) of any Enbridge facility
- lifts are not directly over, or swing over, an exposed Enbridge facility
- outrigger pads that are appropriately sized are used
- the crane boom does not extend over above-grade Enbridge facilities during lifting operations
- that if a lift must occur over an Enbridge facility, the proposed lift plan must be submitted for an engineering assessment to determine appropriate mitigation requirements to protect the facility from a dropped load risk

5.7 Temporary Protective Structures

5.7.1 Temporary Protective Structure Designs

The applicant must provide engineered designs related to temporary protective structures occurring within the Enbridge right-of-way or within 5 m (16 ft) of any Enbridge facility.

5.7.2 Adjacent Structure or Foundation Protection

The applicant must ensure that a professional engineer be consulted to review the stability of any Enbridge structure or foundation that might be affected by an excavation or trench. If required, a temporary protective structure must be designed, constructed and installed to support the structure or foundation in accordance with the specifications of a professional engineer.

5.7.3 Shoring and Trench Boxes

Applicants must ensure that:

- all shoring and trench boxes are installed and removed as per the manufacturers' specifications and in accordance with applicable regulations

- before a trench box is installed, a copy of the engineering certificate or a stamped engineering drawing, including assemble and disassemble instructions, is:
 - sent to Enbridge
 - available on the worksite
 - identifiable to that trench box
- trench boxes stacked in deep excavations are adequately secured to one another in accordance with the engineered design
- only professionally engineered hoisting points and hoisting connectors or manufacturer approved lifting methods are used to lift trench boxes
- the space between the trench box and the excavation wall is backfilled to limit soil movement in the event of a cave-in

5.7.4 Temporary Crossing Ramps and Air Bridges

5.7.4.1 When Ramps and Air Bridges are not Required

Temporary crossing ramps or air bridges are not required if there is more than 3 m (10 ft) of depth of cover and the vehicle weight is less than 25,400 kg (56,000 lb) per axle or for a tracked vehicle less than 27,270 kg (60,000 lb). Note that some regions might have more stringent weight requirements for specific pipelines.

5.7.4.2 Temporary Crossing Ramps

When deemed required by Enbridge, the applicant must construct temporary crossing ramps in accordance with Figure 7: Crossing Ramp – Typical Drawing and Figure 8: Crossing Ramp with Mats – Typical Drawing in Section 3.3.3, Typical Crossing Drawings.

The applicant must:

- maintain crossing ramps so that rutting or degradation of the ramps does not reduce the required minimum depth of cover
- remove all ramps during demobilization, unless otherwise approved in writing by Enbridge
- remove the complete ramp and restore the area as close as practical to its original condition at the end of construction
- adhere to the minimum depth of cover as specified on the consent
- adhere to the minimum clearances noted in Figure 7 and Figure 8 in Section 3.3.3, Typical Crossing Drawings
- ensure the ramp deck is a minimum of 4800 mm (16 ft) on either side of the centre of the pipeline
- when using rig mats, ensure:
 - the ramp deck is a minimum 4800 mm (16 ft) on either side of the centre of the pipeline
 - the rig mats are centred over the pipeline and have a minimum span of 2400 mm (8 ft) on either side of the pipeline
- ensure the width of the ramp does not encroach beyond the boundaries set in the consent
- ensure the ramp side slope is not steeper than 1 vertical to 4 horizontal
- ensure the ramp is compacted and has a cross-fall to ensure water will not pond on the ramp causing excessive rutting
- install a geotextile or liner barrier, at the discretion of the Enbridge Representative

- for multiple lines, ensure there is a minimum of 4800 mm (16 ft) clearance from the centre of the outer-most pipelines

See Section 3.3.3, Typical Crossing Drawings for ramp drawings (Figure 7: Crossing Ramp – Typical Drawing and Figure 8: Crossing Ramp with Mats – Typical Drawing).

5.7.4.3 Air Bridge Requirements

An air bridge may be approved if the air bridge meets the following criteria, otherwise the applicant needs to submit a design using the “[Crossing and Encroachment Application](#)”:

- edge of the footing mat to the edge of the facility is a minimum of 1.5 m (5 ft)
- timber footing mats are 2.4 m x 3 m (8 ft x 10 ft). Using larger steel framed rig mats requires larger footing mats. The width of the ramp must be sufficient to accommodate equipment. Additional footing mats must be staggered so that loads are effectively spread across the footing mats.
- overlap of a rig mat to the footing mat is a minimum of 0.6 m (2 ft)
- ramp is perpendicular to the pipeline

An air bridge may be approved in the field using the “[Crossing and Encroachment On-Site Application and Consent](#)” if the air bridge meets the above criteria and the minimum depth of cover is 1 m (3 ft).

See Section 3.3.3, Typical Crossing Drawings for an air bridge drawing (Figure 9: Air Bridges – Typical Drawing).

5.8 Backfilling and Compaction Requirements

Backfilling and compaction around an Enbridge facility must be done by, or under the direct supervision of, Enbridge and must adhere to the Enbridge construction and engineering standards.

Within the right-of-way, drive or ride-on compaction and vibratory equipment with the vibratory mechanism engaged is prohibited without an assessment.

Minimum requirements for compaction and vibratory equipment:

- drive or ride-on compaction and vibratory equipment is allowed within 1 m (3 ft) horizontal distanced of a pipeline if all the following conditions are met:
 - no vibratory mechanism engaged
 - less than 9,072 kg (20,000 lb) per axle
 - at least 1.2 m (4 ft) of cover
- hand-held compaction equipment (including vibratory equipment) is allowed:
 - within 0.6 m (2 ft) vertical and horizontal clearance of the pipeline
 - within 0.6 m (2 ft) vertical and 0.3 m (1 ft) horizontal clearance of the pipeline with approval

If the above requirements are not met, the applicant must complete and submit a “[Crossing and Encroachment Application](#)” to the Crossings group for an engineering assessment and approval, and include compaction equipment information in [Figure 16, Compaction Equipment – Typical Drawing](#) in Section [3.3.3, Typical Crossing Drawings](#).

5.9 Subsurface Installations

5.9.1 Subsurface Installation Requirements

The crossing angle for installations must be within 45–90 degrees (with preference for as close to perpendicular as possible). All underground facilities must maintain an even elevation across the entire width of the right-of-way, except for gravity-type facilities or those facilities installed by horizontal directional drill (HDD).

Ensure non-metallic underground facilities, excluding agricultural drain tile, have a tracer line, EMS ball markers, RFID tags or other alternative locate marking method acceptable to industry. Tracer wire is to terminate at a location approved by an Enbridge Representative where it is still accessible for future locating purposes. Tracer wire is to be secured at appropriate intervals to an applicant's underground pipeline.

High-capacity fibre optic lines and electric lines must be installed in conduit or casing (Schedule 80 minimum or equivalent) or concrete encasement (dyed red if electrical) with tracer wire. This conduit or casing must be maintained at a minimum of 3 m (10 ft) to each side of any Enbridge facility or the entire width of the Enbridge right-of-way, whichever is the greater distance.

Where the applicant's facility is a steel pipeline, the applicant must design and install, at a minimum, a cathodic protection test station equipped with two coated cathodic protection test leads connected to the applicant's facility at the nearest reasonable access location, as determined and approved by an Enbridge Representative. See [Figure 5: Test Lead Connection for Steel Pipeline – Typical Drawing](#).

5.9.2 Open Cut Installations

5.9.2.1 Above an Enbridge Facility Requirements

Technical Requirements

Applicants must:

- achieve a minimum clearance of 0.6 m (2 ft) for cable (TV, telephone or fibre), utility pipelines NPS 6 and less and electrical lines less than 750 V; all other installations require a minimum of 0.6 m (2 ft) clearance, unless otherwise stated
- use utility warning tape 0.3 m (1 ft) below grade, in accordance with APWA Uniform Colour Code, and in the bottom of the trench (colour coded to corresponding Enbridge pipeline) across the entire width of the Enbridge right-of-way, unless otherwise directed
- initially add two layers of geotextile material, if an aggregate base is used at the bottom of the proposed trench

Field Approved Activities

Subsurface activities listed below that meet the requirements above may be approved in the field using the "[Crossing and Encroachment On-Site Application and Consent](#)," otherwise the applicant will need to submit a design using the "[Crossing and Encroachment Application](#)":

- cable (coaxial)/telephone
- non-metallic pipelines NPS 6 and less
- fibre optics
- electrical less than 750 V
- drain tile

See Section 3.3.3, Typical Crossing Drawings, for subsurface installations above an Enbridge facility (Figure 4: Facility Crossing – Typical Drawing).

5.9.2.2 Below an Enbridge Facility Requirements

Technical Requirements

Applicants must:

- achieve a minimum clearance of 0.6 m (2 ft), unless otherwise stated
- take appropriate measures to prevent trench/pipe settlement and to take special care to ensure that the compaction between the utility and the Enbridge pipeline is sufficient to mitigate settlement and voids
- ensure the maximum unsupported span is 4.5 m (15 ft) for any Enbridge facility

Field Approved Activities

Subsurface activities listed below that meet the requirements above may be approved in the field using the "[Crossing and Encroachment On-Site Application and Consent](#)," otherwise the applicant will need to submit a design using the "[Crossing and Encroachment Application](#)":

- cable (coaxial)/telephone
- non-metallic pipelines NPS 6 and less
- fibre optics
- electrical less than 750 V

See Section 3.3.3, Typical Crossing Drawings, for subsurface installations above an Enbridge facility (Figure 4: Facility Crossing – Typical Drawing).

5.9.3 Boring Subsurface Installation Requirements

5.9.3.1 Technical Requirements for Boring

The applicant must adhere to the following minimum clearance requirements:

- for horizontal directional drills (HDDs), 3 m (10 ft)
- for horizontal directional bores (HDBs), 1 m (3 ft), but can be reduced to 0.6 m (2 ft) providing:
 - positive identification of the underground facility before digging
 - positive identification (by slot hydrovac or hand excavation) confirms the position of the boring device and the installed foreign facility maintains a clearance of at least 0.6 m (2 ft) prior to intersecting the front edge of the Enbridge underground facility
 - verification of the crossing consent that allowed the reduced clearance included an engineering review that determined there is no negative long-term impacts to the Enbridge facility

Note: The clearance is measured by the closest edge of the bore path (largest reamer used) to the closest edge of an Enbridge facility, which must be met when performing these activities.

5.9.3.2 Boring Operation General Requirements

Before beginning operations, applicants must ensure that:

- a boring plan and design are submitted with the application
- entry and exit angles are outside the Enbridge right-of-way
- boring equipment is secured or anchored to prevent movement

During operations, applicants must:

- continuously confirm the depth and alignment during the advancement of boring operations, including the reamed path or pilot hole
- use specialized mechanical equipment (e.g., hydraulic style tongs) to break the drill strings (when applicable for the boring type); use of manual tongs and/or excavator buckets is prohibited
- ensure all cables used to lift drill stems are inspected, in good condition, rated for the required load and free of knots (when applicable for the boring type)
- **not** do blind boring; both the Enbridge pipeline and the bore head must be positively identified (i.e., potholed) to verify clearances

5.9.4 Drainage Tile Crossing Enbridge Pipelines Requirements

Drain tile activities that meet the technical requirements below may be approved in the field using the “[Crossing and Encroachment On-Site Application and Consent](#),” otherwise the applicant needs to submit an application using the “[Crossing and Encroachment Application](#)”:

- 0.3 m (1 ft) vertical clearance for perpendicular pipeline
- 5 m (16 ft) or greater from the edge of the pipeline if parallel to the pipeline and outside the right-of-way
- equipment used must comply with vehicle crossing requirements and the location must comply with minimum clearance requirements

5.10 Above-Grade Installations

5.10.1 General Requirements for Above-Grade Installations

Above-grade installations include such things as roads, railways, signs, fence posts and overhead power and communications lines.

Applicants must ensure for the following installations that:

- structures with underground supports, foundations, pilings or anchors (e.g., buildings or pools) are not installed within the Enbridge right-of-way or within 5 m (16 ft) of any Enbridge facility, whichever is the greater distance
- a minimum vertical clearance of 1.5 m (5 ft) for roadways, sidewalks and parking lots
- a minimum vertical clearance of 3 m (10 ft) for railways

For additional requirements, see other subsections below.

See Section 3.3.3, Typical Crossing Drawings, for a typical drawing of an above-ground installation (Figure 13: Above-Ground Installations – Typical Drawing).

Note: All activities that meet the requirements in Sections [5.10.2](#) to [5.10.11](#) may be approved in the field using the “[Crossing and Encroachment On-Site Application and Consent](#).” Otherwise, the applicant needs to submit an application using the “[Crossing and Encroachment Application](#)”:

5.10.2 Signs, Fence Posts and KP/MP Marker Installations

Requirements are that:

- posts, bars, rods or pins must not be installed within 1.5 m (5 ft) of the horizontal edge of an Enbridge facility

- fence crossings must be at an angle between 45–90 degrees (with preference for as close to perpendicular as possible)
- fences parallel to an Enbridge facility must be off the right-of-way and at least 3 m (10 ft) from an Enbridge facility
- masonry, brick, or stone fences are not permitted to be installed on any Enbridge right-of-way

See Figure 13: Above-Ground Installations – Typical Drawing in Section 3.3.3, Typical Crossing Drawings.

5.10.3 Resurfacing and Re-graveling

The minimum requirements for resurfacing and re-graveling of roads, pathways and sidewalks are:

- resurfacing with a maximum allowed milling/removal of 0.15 m (6")
- resurfacing of up to 0.6 m (2 ft) of fill

See Section 3.3.3, Typical Crossing Drawings, for a typical resurfacing or re-gravelling drawing (Figure 10: Resurfacing or Re-gravelling – Typical Drawing).

5.10.4 Ditch Restoration

The minimum requirement for ditch restoration is that restoration must result in greater than 0.9 m (3 ft) depth of cover post remediation above the facility (excluding ditches in railway rights-of-way).

See Section 3.3.3, Typical Crossing Drawings, for a typical ditch restoration drawing (Figure 11: Ditch Restoration – Typical Drawing).

5.10.5 Minor Berms

Minimum requirements for minor berms are:

- up to 1 m (3 ft) high
- not to exceed total depth of cover of 2.1 m (7 ft) above a facility

See Section 3.3.3, Typical Crossing Drawings, for a typical minor berm drawing (Figure 12: Minor Berms – Typical Drawing).

5.10.6 Spreading or Replacing Soil Fill Material

Minimum requirements for spreading or replacing soil fill material are:

- less than 1 m (3 ft) depth of additional soil and not to exceed a total depth of cover of 2.1 m (7 ft) above a pipeline
- soil fill material spread on land that is not on a slope
- equipment used must comply with vehicle crossing requirements and no excavation is involved

5.10.7 Topsoil Stripping/Levelling and Clearing/Grading

Topsoil stripping/levelling and clearing/grading activities require Enbridge review and approval.

5.10.8 Ancillary Installation, Above-Ground Installation or Temporary Storage

When a parcel size and proximity of houses limits the ability to access the right-of-way and/or limits the ability of the landowner to place a private facility or encroachment off the right-of-way, Enbridge might allow upon approval, installations on the right-of-way subject to the following minimum requirements:

- garden plots must be a minimum of 0.6 m (2 ft) of cover above a facility

- trees and shrubbery mature height must not exceed 1.5 m (5 ft) and must maintain a minimum horizontal distance of 3 m (10 ft) from the nearest facility
- storage sheds must be movable on short notice with no permanent foundation and cannot be larger than 3 m x 3 m (10 x 10 ft), with a minimum horizontal distance of 3 m (10 ft) from the edge of the nearest facility
- play equipment must all be above surface (at grade level or above) and moveable on short notice
- nurseries must have a minimum horizontal clearance of 3 m (10 ft) from the edge of the nearest facility
- materials such as hay bales and wood piles must have a minimum horizontal clearance of 3 m (10 ft) from the edge of the nearest facility
- movable equipment, trailers, boats or vehicles stored on the surface must meet the requirements of vehicle crossings (see Section [5.10.11](#)) and be moveable on short notice

5.10.9 Agricultural Ground Disturbance

Operation of agricultural vehicles or mobile equipment across a pipeline for the purposes of performing an agricultural activity can be performed without written consent from Enbridge provided:

- the loaded axle weight and tire pressures of the vehicle or mobile equipment are within the manufacturer's approved limits and operating guidelines
- the point of crossing has not been the subject of a notification from Enbridge that crossing at that location could impair the pipeline's safety or security
- cultivation is less than 0.45 m (1.5 ft) deep below the surface
- soil disturbance is less than 30 cm (1 ft) deep if it does not reduce the earth cover over the pipeline below the level when the pipeline was constructed

Agricultural activities that do not meet the above conditions can receive approval upon an application for consent.

5.10.10 Vegetation Control

Minimum requirements for vegetation control are that:

- equipment used must comply with vehicle crossing requirements
- burning, brushing, tree clearing and stump grinding of existing vegetation growing on the right-of-way is permissible if it complies with crossing requirements, and any ground disturbance is no more than 0.3 m (1 ft) deep, and stays 1 m (3 ft) horizontally from the outer diameter of the Enbridge facility
- removal of root systems of trees that are less than 1.5 m (5 ft) tall and are located within the ground disturbance zone (see Section [2.4](#)) but more than 3 m (10 ft) from an Enbridge facility

Note that removal of the root system might have to be completed by an Enbridge approved contractor at the cost of the applicant as the removal might negatively impact the integrity of the facility.

5.10.11 Vehicle Crossings – Wheeled and Tracked Vehicles

- Operation or movement of highway permissible vehicles, mobile equipment or machinery across an Enbridge right-of-way, on the travelled portion of a highway or public road do not require assessment. Refer to section [2.4.4](#) for other regulatory exemptions

Minimum requirements for on-site consent for temporary vehicle crossings are that:

- where there is a confirmed depth of cover of at least 1.2 m (4 ft):
 - wheeled vehicles must weigh less than 9,072 kg (20,000 lb) per axle
 - tracked vehicles must weigh less than 9,072 kg (20,000 lb) total weight
- where there is a confirmed depth of cover of at least 3 m (10 ft):
 - wheeled vehicles must weigh less than 25,400 kg (56,000 lb) per axle
 - tracked vehicles must weigh less than 27,270 kg (60,000 lb)
- applicants must stay 5 m (16 ft) away from Enbridge facilities at all times, except at the approved temporary equipment crossing location
- the approved temporary crossing location must be over straight pipeline only and to a maximum width of 8 m (26.25 ft) on either side of the specified GPS coordinates

Note that some regions might have more stringent weight requirements for specific pipelines than noted above.

Equipment that has been previously approved might be eligible for preapproval for future use.

For all other equipment that cannot be approved by on-site consent, submit a “Crossing and Encroachment Application” through the Crossings department.

See Section 5.7.4, Temporary Crossing Ramps and Air Bridges, for alternative vehicle-crossing technical requirements.

See Section 3.3.3, Typical Crossing Drawings for additional wheeled and tracked vehicle information requirements (Figure 14: Tracked Vehicles – Typical Drawing and Figure 15: Wheeled Vehicles – Typical Drawing).

5.10.12 Road Crossings

Enbridge should be contacted as early as possible, either during the concept or planning stages of a road crossing that may cross or impact an Enbridge right-of-way. Early notification will ensure Enbridge can:

- properly assess the impact on safety, the environment and assets
- complete required engineering assessments so that recommendations can be incorporated into the design
- complete any mitigative work in time to avoid impacting construction schedules

See Section I), Wheeled Vehicles

Items to Include on Wheeled Vehicle Drawings

Complete all information in the typical drawing section for wheeled vehicles.

- For road legal vehicles, submit a typical drawing including the table, in Section [3.3.3. Typical Crossing Drawings \(Figure 15: Wheeled Vehicles – Typical Drawing\)](#) for each of the heaviest axle load per grouping by axle configuration, e.g., the heaviest single, heaviest tandem, heaviest tridem vehicle.
- For non-road legal vehicles, submit a typical drawing including the table, in Section [3.3.3. Typical Crossing Drawings \(Figure 15: Wheeled Vehicles – Typical Drawing\)](#) for each vehicle.

o) Tracked Vehicles

Items to Include on Tracked Vehicle Drawings

- Submit a typical drawing including the table in Section 3.3.3, Typical Crossing Drawings (Figure 14: Tracked Vehicles – Typical Drawing) for each tracked vehicle.

p) Compaction Equipment

Items to Include on Compaction Equipment Drawings

- Submit a typical drawing including a table in Section 3.3.3, Typical Crossing Drawings (Figure 16: Compaction Equipment – Typical Drawing) for each piece of compaction equipment.

Typical Crossing Drawings, for a typical road-crossing drawing (Figure 3: Road Crossing – Typical Drawing).

5.10.13 Railway Crossings

Enbridge should be contacted as early as possible, either during the concept or planning stages of a railway crossing that may cross or impact an Enbridge right-of-way. Early notification will ensure Enbridge can:

- properly assess the impact on safety, the environment and assets
- complete required engineering assessments so that recommendations can be incorporated into the design
- complete any mitigative work in time to avoid impacting construction schedules

See Section 3.3.3, Typical Crossing Drawings, for a typical railway crossing drawing (Figure 6: Railway Crossing – Typical Drawing).

5.11 Power and Communication Installations

5.11.1 Consent Limitation

Changes in power line operating characteristics or configuration that are outside the parameters of the original power line consent (e.g., increased maximum load, introducing or removing a phase transposition) must be reported to Enbridge for assessment.

5.11.2 Overhead Power Less Than 60 kV and Communication Installation

Technical Requirements

Note, for power lines 60 kV or higher, see the section below for transmission power.

Minimum requirements for overhead power lines less than 60 kV and communication lines are that:

- pole placement for overhead power lines and associated appurtenances, telephone lines and telecommunication installations:
 - if the Enbridge facility is a transmission pipeline:
 - must be outside of the Enbridge right-of-way or at least 10 m (33 ft) horizontally away from any Enbridge facility, whichever is the greater distance
 - if the Enbridge facility is a gas distribution pipeline:
 - the clearance distance may be less than 10 m (33 ft) but kept as far away as practicable
 - the minimum required safe clearances for power lines based on operating voltage provided in Table 3 should be maintained

- minimum vertical clearance must be 8 m (26.25 ft) from the top of grade to any cable or lines crossing the right-of-way along with any associated appurtenances

Table 3: Overhead AC Distribution Power Line Horizontal Clearances for Distribution Pipelines

System Voltage (kV)	Minimum Horizontal Clearance Distance*	
	m	ft
<=12.8	0.3	1
<=14.4	0.4	1.2
<=16.6	0.6	1.8
<=25	1.3	4.1
<=45	2.9	9.5
<60	4.2	13.5

*Note: These distances are conservative and assume that the power line structure reaches the phase-to-ground voltage of the power line. Where these clearances cannot be maintained, smaller distances might be acceptable, if modelling and additional calculations demonstrate that the arcing risk is negligible.

Field Approved Activities

Pole placement for overhead power lines and associated appurtenances, telephone lines and telecommunication installations may be approved in the field using the “Crossing and Encroachment On-Site Application and Consent” if the proposed installation meets the technical requirements above and subject to the following conditions, if applicable:

- for transmission and distribution pipelines: power lines must be less than 100 m (330 ft) of continuous parallel lines to the pipeline for clearances of less than 50 m (160 ft) from the centre line of the pipeline
- for distribution pipelines: for power lines less than 12.8 kV and communication lines, a minimum clearance of 1 m (3 ft) should be maintained where possible, but no less than 0.3 m (1 ft). Less than 1 m (3 ft) would be acceptable only with the following mitigation measures:
 - signage must be installed on each pole on the side facing the gas main warning that there is a gas main in close proximity and no ground disturbance (or ground rods) are allowed on this side
 - ground rods or any potential grounding points, e.g., anchors, (if required) should be installed on the opposite side of the pole from the pipeline, if possible

5.11.3 Power Line Data Requirements for Transmission Power

5.11.3.1 Power Lines More Than 60 kV

Application Requirements

Applicants must submit a “Crossing and Encroachment Application” if a power line:

- is equal to or more than 60 kV and encroaches within the right-of-way or crosses the pipeline
- is equal to or more than 60 kV and is paralleling the pipeline for more than 100 m (330 ft) and has a horizontal clearance of less than 500 m (1640 ft) from the pipeline

Crossing and Encroachment Guide and Requirements – Canada



- is a DC power line

Safe Clearances

The minimum safe horizontal clearance distances between a pipeline and power line structures, grounding and anchors to avoid arcing risks are as follows:

- if the Enbridge facility is a transmission pipeline:
 - power line structures, grounding and anchors must be outside of the Enbridge right-of-way and at least 10 m (33 ft) away from any Enbridge facility, whichever is the greater distance
- if the Enbridge facility is a gas distribution pipeline:
 - the clearance distance may be less than 10 m (33 ft) but kept as far away as practicable
 - the minimum required safe clearances for power line structures, grounding and anchors based on operating voltage provided in [Table 4](#) should be maintained
- minimum vertical clearance for all pipelines must be 8 m (26.25 ft) from the top of grade to any cable or lines crossing the right-of-way along with any associated appurtenances

Table 4: High-Voltage AC Power Line Horizontal Clearances from Structures, Grounding and Anchors for Distribution Pipelines

System Voltage (kV)	Minimum Horizontal Clearance Distance ^{1,2}			
	Power Line with Shield Wires		Power Line without Shield Wires	
	m	ft	m	ft
60	4.2	13.5	4.2	13.5
<=69	5	16	5	16
<=115	9	29	9	29
<=144	10	33	12	37
<=240	10	33	19	62
<=345	10	33	28	91
<=500	10	33	41	133
<=735	10	33	60	196
>735	Requires review		Requires review	

Notes:

1. Structures must be outside of the right-of-way and meet the minimum clearances from the pipeline as set forth in this table.
2. These distances are conservative and assume that the power line structure (without shield wires) reaches the phase-to-ground voltage of the power line. Where these clearances cannot be maintained, smaller distances may be acceptable, if an engineering assessment including modelling and additional calculations demonstrate that the arcing risk is negligible.

5.11.3.2 Information Required for Each Transmission Power Line

The following information is required for each transmission power line equal to or greater than 60 kV near an Enbridge pipeline.

Items to Include on Overhead Transmission Power Drawings

Power circuit number, ID number and name:

System voltage (line to line):

- Staking list showing chainages and GPS coordinates of all structures: from substation to substation for *parallel studies, and at least five structures upstream and downstream of crossing locations without *parallel.
- Cross-section drawings of the power lines structures, showing the positions of all conductors (phase conductors, shield wires), including:
 - vertical and horizontal clearance between conductors
 - average height of conductors, or height of conductors at the tower and at mid-span
 - circuits and phase arrangement for each circuit (i.e., A-B-C top-bottom)Please indicate the direction looking at the structure at each cross-section
- Shield wire information:
 - # of shield wires
 - shield wire size, type (material)
 - shield wire resistance (ohm/unit length)
 - continuous or segmented
 - continuous with substation grounding at extremities
- Tower grounding:
 - typical grounding details (drawing or sketch), if grounding electrodes are used
 - tower foundation details (suspension towers only), to estimate the resistance of the “natural grounding” provided by the tower foundation
 - grounding resistance of each tower, if known, or an average grounding resistance
 - details of counterpoise, if any
 - details of guy wire anchors, if any
- Locations and details of any phase transpositions along the common right-of-way (pipeline chainage or GPS coordinates of the transposition towers or marking on the drawings). Please indicate the phase arrangement at each transposition tower.
- Phase current loading:
 - peak annual
 - peak projected
 - average annual
 - average projected
 - emergency
 -
- Line-to-ground fault currents:
 - a. at beginning of common right-of-way:
 - total fault current

Items to Include on Overhead Transmission Power Drawings

- fault current contributions from the north/east
- fault current contributions from the south/west
- b. at middle of common right-of-way:
 - total fault current
 - fault current contributions from the north/east
 - fault current contributions from the south/west
- c. at end of common right-of-way:
 - total fault current
 - fault current contributions from the north/east
 - fault current contributions from the south/west
- Line-to-ground fault duration:
 - minimum (primary protection)
 - maximum (backup protection)
- Substation layout drawings and grounding impedances at both ends of each transmission line circuit, if available.

* “Parallel” refers to the pipeline(s) and power line(s) situated side-by-side or low angle (<45 degree) crossings with a clearance distance of 750 m (2461 ft) or less.

5.12 Geophysical – Blasting, Quarrying and Seismic

Applicants must notify Enbridge of any geophysical activities occurring within 300 m (985 ft) of the pipeline right-of-way so that Enbridge can review the proposed plans to see if there might be potential impacts to its facilities.

An applicant’s failure to consult Enbridge before beginning activities requiring the use of explosives (i.e., blasting/seismic exploration) within 300 m (985 ft) of a pipeline right-of-way might result in damages to Enbridge facilities, the public, environment and/or property for which the applicant might be held liable.

Contact Enbridge for additional application requirements (see Section 3.3.2i) Blasting – Including Seismic and Geophysical Activities).

Applicants must also apply to the CER for any blasting activities related to prospecting for mines and minerals within 40 m (130 ft) of a CER regulated pipeline right-of-way.

5.13 Site Restoration Requirements

Applicants must ensure that:

- no trees with mature height exceeding 1.5 m (5 ft) are allowed within an Enbridge right-of-way or within 8 m (26.25 ft) of any Enbridge facility, whichever is the greater distance
- the site is restored to as close as practical to its original condition, except for expressly agreed upon exceptions
- unless approved by Enbridge, no reduction in final grade or drainage alteration over any Enbridge facility is permitted
- all landscaping within any Enbridge right-of-way needs to be approved by Enbridge before installation

6 Emergency Situations and Enbridge Emergency Contact Numbers

6.1 Notice of Access

In an emergency, please provide Enbridge with as much notice of access to the emergency site as practicable before beginning any construction, excavation, installation or temporary activities affecting existing pipelines and/or rights-of-way.

6.2 Enbridge Definition of Emergency

Enbridge classifies an emergency as:

- a risk to human life
- required emergency repairs of public services
- containment of an environmental emergency

6.3 One-Call Centres

In an emergency, contact your local One-Call provider at the numbers listed in Section 4, Requirements Before Construction – One-Call Centres and Locate Requests.

6.4 Enbridge Emergency Contact Numbers

Also contact Enbridge at the following emergency contact numbers.

Table 5: Enbridge Crude Oil and Liquids Emergency Numbers for Canada

Canada	
Alberta/Northwest Territories	1-877-420-8800 or 1-888-813-6844 (Athabasca system) 1-877-420-8800 (Norman Wells system)
Express Canada	1-888-449-7539
Saskatchewan	1-877-420-8800
Manitoba	1-877-420-8800
Ontario	1-877-420-8800
Quebec	1-877-420-8800

Table 6: Enbridge Gas and Midstream Emergency Numbers for Canada

Canada	
Alliance Pipeline	1-800-884-8811
British Columbia and Alberta (Westcoast)	1-800-663-9931
Maritimes & Northeast Pipeline	1-888-444-6677

Table 7: Enbridge Gas Distribution Emergency Numbers for Canada

Ontario (Enbridge Inc.)		Quebec	
Southern and Eastern Ontario	1-866-763-5427	Gazifère	1 (819) 771-8321
Southwest and Northern Ontario	1-877-969-0999		
Gas storage	1-800-255-1431		

Table 8: Enbridge Renewable Power and Power Transmission Emergency Numbers for Canada

Canada	
24 hours, toll free	1-866-420-6630
MATL (Alberta)	1-888-780-8831

7 Definitions

Applicant – A facility owner, a company, a person, a municipality or government body requesting consent.

Facility – Any structure, public or private road, railway, irrigation ditch, drain, drainage system, sewer, dike, telephone line, telegraph line, telecommunication line and line for the transmission of electricity or pipe for the transmission of hydrocarbons or any other substance.

Horizontal Directional Bore (HDB) – A horizontal directional installation that meets ALL of the following:

- (a) The designed horizontal distance of the crossing must be less than or equal to 150 m (500 ft) in length
- (b) The depth of the pipeline installation must be limited to 8 m (26.25 ft) to the centre (cross-section) of the pilot hole and measured to the corresponding surface location
- (c) Straight alignment in the vertical plane
- (d) Pilot bit is steerable and trackable

Horizontal Directional Drill (HDD) – A horizontal directional installation that DOES NOT meet one or more of the criteria for an HDB.

Jack and Bore – Auger Boring – Jack and bore meets the definition of horizontal directional bore, with the exception of (d). Auger boring, often referred to as 'jack and bore,' is a method of horizontal directional installation that simultaneously jacks casing while rotating helical augers within the casing to remove spoil. A cutting head is attached to the 'lead' auger and can protrude just ahead, sit flush, or sit within the casing depending on the job requirements. Hydraulic jacks located on the bore machine in the sending shaft provide the thrust that push the casing through the ground. The rotating augers carry the spoil to the back of the casing pipe for removal by muck bucket, excavator or conveyor.

Method of Installation – The process by which the proposed permanent installation will be constructed.

Minimum Clearance – The minimum distance acceptable between an existing facility and the proposed facility based on the selected method of installation.

Non-Road Legal Vehicle – A vehicle that is not equipped and licensed for use on public roads.

Open Cut – A trench methodology wherein access is gained to the required level underground for the proposed installation, maintenance or inspection of a facility. The excavated trench is then backfilled and the surface restored.

Permanent Installation – An installation that will remain in place for the life of the facility.

Pile Drive – The installation of a deep foundation unit (i.e., pile) by dropping a rig- or truck-mounted hydraulic hammer repeatedly on the pile head to advance it into the ground, or using a vibratory-type installation method.

Preliminary Design – Initial inquiry by an applicant to Enbridge in order to obtain relevant information about Enbridge facilities to be used during the design phase of the applicant’s proposed permanent installation and/or temporary activities.

Proximity – Ground disturbance within 30 m of either sides of the centreline of a Canada Energy Regulator or Alberta Energy Regulator regulated pipeline.

Right-of-Way – The area of land defined in the easement agreement for the purpose of construction, operation and maintenance of a facility.

Road Legal Vehicle – A vehicle that is equipped and licensed for use on public roads.

Road Use – Temporary or permanent use of an industry-owned road, which may include road use fees.

Temporary Access of Right-of-Way – Temporary surface use by the applicant of an Enbridge right-of-way, travelling parallel to an existing pipeline or on fee-simple land, owned by Enbridge in order to travel to a construction or work site.

Temporary Activities – An activity with a set expiry date.

Temporary Equipment/Vehicle Crossing – Temporary surface crossing of an existing Enbridge facility by equipment or vehicles.

Temporary Protective Structure - A structure or device designed to provide protection to workers, adjacent structures, excavations, tunnels and or underground shafts from sliding or rolling materials, cave-ins and/or collapses, e.g., trench boxes, shoring, bracing, piles, timbers and cages.

Temporary Workspace – Temporary surface use over an existing facility or right-of-way for construction purposes.