



---

# LP Safety Standards

---

**Effective Date:** 2019-03-30

**Version #:** 18.0

**Version Date:** 2024-04-30

---

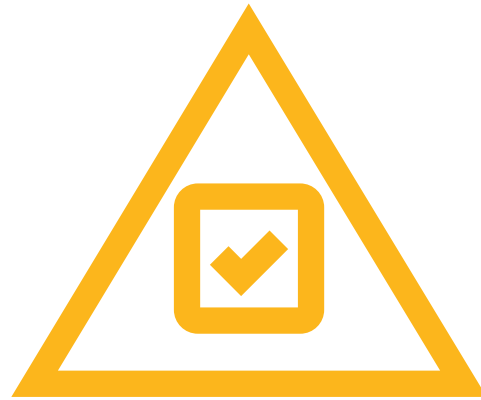

**Rule 1  
Hazard Management**

I will complete a hazard assessment prior to starting work and reassess if conditions change and new hazards are introduced



**Rule 2  
Driving Safety**

I will only operate a motor vehicle or mobile equipment when free from the adverse effects of alcohol or any substance that causes impairment



**Rule 3  
Confined Space Entry**

I will confirm the atmosphere has been tested, is monitored and a plan is in place prior to entering a confined space

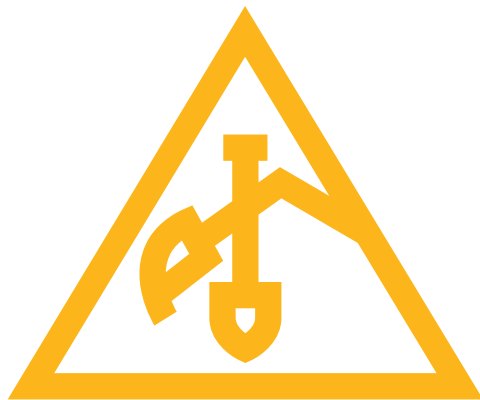

**Rule 4  
Ground  
Disturbance**

I will verify the location of buried utilities through surface locating and positive identification prior to conducting a mechanical excavation



**Rule 5  
Isolation of  
Energized Systems**

I will verify isolation and zero energy before work begins on energized or pressurized systems (Lockout/Tag-Out)

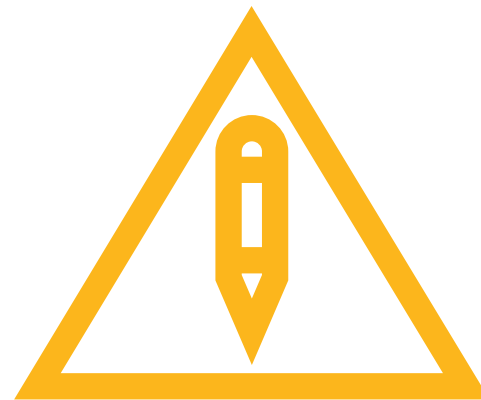

**Rule 6  
Reporting Safety  
Events**

I will immediately report significant safety-related events



**Rule 7  
Bypassing Safety  
Controls**

I will obtain authorization before overriding or disabling safety-critical equipment or controls

## Lifesaving Rules

**Working for Enbridge means working safely.** At Enbridge, we value the safety of our communities, customers, contractors and employees. Together, we must strive to make sure work-related injuries and fatalities are a thing of the past. The Lifesaving Rules are seven simple and powerful rules based on real safety events at Enbridge and developed in consultation with some of the top safety experts in the world. These rules focus our attention on the high-risk, high-consequence hazards of our work and the key actions we must take to protect ourselves and our colleagues from harm. The Lifesaving Rules help us to deliver on our shared commitment that every member of the team goes home safe at the end of every day.

For more information, visit **ELink** and search **Lifesaving Rules**.





# Our Path to Zero

## Safety principles at Enbridge **OUR COMMITMENT**

---

Enbridge is committed to ensuring everyone returns home safely at the end of each and every day, and that our assets are operated in a safe and reliable manner.

**We base our commitment to safety on our care for employees, contractors, the communities in which we operate and the environment.**

Our values of Safety, Integrity, Respect and Inclusion guide our decisions, actions and interactions individually and as a company. Our Safety Principles support our values and highlight the fundamental beliefs we share on our path to a zero-event workplace.

Safety. It's a core value that makes us Enbridge. It's our way of life.

## Safety principles **OUR PATH TO ZERO**

---

### **1. All injuries, events and occupational illnesses can be prevented.**

Enbridge is committed to protecting the health and safety of our employees, our contractors and the public. Our goal is zero injuries, events and occupational illnesses. Striving for anything less can lead to the false belief that injuries, events and occupational illnesses are inevitable and acceptable. In every instance, protecting the health and safety of workers and the public requires strict adherence to company policies and procedures, including Enbridge's Lifesaving Rules.

### **2. All operating exposures can be controlled.**

Enbridge believes that all operating exposures and uncontrolled releases that may result in injury, illness or environmental damage can be prevented. Through the rigorous application of process safety requirements we strive to eliminate hazards and minimize risks by implementing effective safeguards. When it is not possible or practical to completely eliminate hazards, we implement engineering controls such as fail-safe control systems, warning and detection devices, and automatic safety devices to reduce the risk. Administrative controls and/or personal protective equipment serve as the last line of defense against the hazards we face.

### **3. Leaders are accountable for safety performance.**

People leaders are accountable for safe operations and the safety and health of the workers under their care. This includes accountability for establishing and maintaining a safe work environment through the application of our Management System. As well, it includes establishing, regularly reviewing and updating policies and procedures using disciplined change management, providing the proper equipment, completing appropriate training, correcting deficiencies promptly, and ensuring approved procedures are followed.

### **4. All employees/contractors are responsible for safety.**

People are the most important element of our health and safety program and ensuring our operational reliability. Enbridge expects employees and contractors to take personal accountability for their safety, that of their co-workers and the general public, and the safe operations of our assets. Further, workers have not only a right but a duty to stop and/or refuse work they feel is unsafe. Our success depends on all levels and all members of the organization being committed and accountable for consistently adhering to our company policies and procedures as well as all applicable regulations, codes and standards. Working safely is a condition of employment.

### **5. Assessment and improvement are a must.**

Enbridge is committed to continuously improving our safety performance through field and operational assessments, and diligent application of quality and safety assurance practices and processes. Further, we employ disciplined root cause analysis and thoughtful exploration of human factors during event analyses to identify and learn from weaknesses in our safety systems. We promptly address deficiencies revealed through these activities, and communicate what we learn across the organization to strengthen our systems and make Enbridge even safer.

### **6. We promote off-the-job health and safety for our employees 24/7.**

Our concern for the safety and health of employees extends beyond the workplace. An off-the-job injury is as painful and impactful as one suffered on the job. We encourage our employees to demonstrate their leadership and excellence in health and safety practices for the benefit of their families, friends and community. An engaged workforce is a key building block of a healthy safety culture.

---

We strive to create a vigilant and resilient safety culture, in which all members of our team keep themselves and others safe, leaders care for the health and safety of their people, and we learn from safety failures to prevent future events. Our Safety Principles are foundational to our safety culture and our long-term success as an organization.



# Standard

---

## Atmospheric Monitoring

---

**Effective Date:** 2019-06-30  
**Version #:** 2.1  
**Version Date:** 2024-03-14

---





This page intentionally left blank.



**Document Version Register**

Version Number	Version Date	Approved By	Section Number and Title	Details of Version
1.0	2019-03-30	Sean Evans	Whole Document (New Standard)	This is the new H&S standard that was developed as part of the LP   MP Safety Manual Transition Project
1.1	2019-10-31	Sean Evans	3.0, 6.1, 6.4,	Clarified requirements
1.2	2020-06-01	Sean Evans	2.0	Alignment with contractor safety specifications
1.3	2021-12-01	Murray Evenson	9.0, 10.0	Updated section 9 to reflect the appropriate review process. Updated references
2.0	2022-08-30	Murray Evenson	6.5	Added Section 6.5
2.1	2024-03-14	Troy Croft	All	Clerical corrections



This page intentionally left blank.

---

## Table of Contents

1.0	Purpose .....	2
2.0	Scope .....	2
3.0	Prerequisites.....	2
4.0	Definitions & Acronyms .....	2
5.0	Roles & Responsibilities.....	3
6.0	Standard-Specific Requirements .....	4
6.1	Portable Atmospheric Monitoring and Sampling – General Requirements .....	4
6.1.1	Personal and Area Gas Monitor Device Requirements.....	6
6.2	Sampling Equipment .....	8
6.3	Initial Atmospheric Monitoring .....	8
6.4	Bump Testing, Calibration, and Maintenance of Equipment .....	9
6.5	Tank Lot Entry .....	10
7.0	Training.....	10
8.0	Related Documents.....	11
9.0	Standard Review .....	11
10.0	References .....	11
	Change Log.....	12

---

## 1.0 PURPOSE

The purpose of this Standard is to provide the minimum requirements for monitoring a worksite for atmospheric hazardous conditions.

## 2.0 SCOPE

This standard applies to LP Operations and Projects being completed for LP.

Contractors and subcontractors shall comply with Enbridge health and safety requirements set out in this standard, as articulated within applicable contractor safety specifications. If a contractor or subcontractor has a health and safety standard or policy materially different from Enbridge's, the contractor/subcontractor shall follow the most stringent requirement. Contractors and subcontractors are still obligated to meet the requirements of all applicable laws related to this standard.

In the event a contractor's or subcontractor's standard exceeds the requirements of this standard, Enbridge may, in its sole discretion, choose to adopt the contractor's or subcontractor's standard for any given contract or work order.

## 3.0 PREREQUISITES

Emergency Preparedness – Personal Safety Standard

Hazard Assessment and Control Standard

Hazard Communication & WHMIS Standard

Inspection Standard

Respiratory Protection Standard

Safe Work Permit and Work Authorization Standard

Storage and Transportation of Hazardous Materials Standard

## 4.0 DEFINITIONS & ACRONYMS

*Active monitors* – A personal gas monitor that has internal pumps that draw atmospheric samples from the immediate area or from a distance (e.g., inside a pipe, sump, booster pit).

*Air-purifying respirator* - A respirator with an air-purifying filter, cartridge, or canister that removes specific air contaminants by passing ambient air through the air-purifying element. (Source OSHA 1910.134)

*Area monitor* - A gas monitor that is positioned in the work environment in a fixed location in a work area.

*Breathing zone* - a hemisphere forward of the shoulders within a radius of approximately 15 to 23 centimeters (6 - 9 inches). (OSHA Technical Manual)

*Bump test* – A qualitative function check where a challenge gas is passed over the sensor(s) at a concentration and exposure time sufficient to activate all alarm indicators to present at least their lower alarm setting. The purpose of this check is to confirm that gas can get to the sensor(s) and that all the alarms present are functional.

*Calibration* - The adjustment of the sensor(s) response to match the desired value compared to a known traceable concentration of test gas. This should be done in accordance with the manufacturer's instructions.

*Hazardous atmosphere* - an atmosphere that may expose employees to the risk of death, incapacitation, impairment of ability to self-rescue (that is, escape unaided from a permit space), injury, or acute illness from one or more of the following causes (1) Flammable gas, vapor, or mist in excess of 10 percent of its lower explosive limit (LEL),

*Immediately dangerous to life or health (IDLH)* - an atmosphere that poses an immediate threat to life, would cause irreversible adverse health effects, or would impair an individual's ability to escape from a dangerous atmosphere. (Source OSHA 1910.134)

*IH* – Industrial Hygiene

*Lower Explosive Limit (LEL)* - That concentration of a flammable vapor in air below which ignition will not occur.

*Passive monitors* – a personal gas monitor that assesses the atmosphere without the use of a pump.

*Personal gas monitor* - A device worn by a person to provide warning when alarm levels of a hazardous atmosphere are reached. A personal gas monitor helps to ensure worker safety by identifying potential hazardous atmospheres.

*ppm* - Parts per million

*Respiratory Protection Equipment (RPE)* - A protective device that covers the nose and mouth or the entire face or head to guard the wearer against hazardous atmospheres.

*Sampling equipment* – Equipment that is used to acquire a sample in the field utilizing several collection devices such as filters, absorbents, adsorbents, impingers. The collected sample is then sent to a laboratory for analysis.

*SCBA* – Self-Contained Breathing Apparatus

*SWP* – Safe Work Permit

## **5.0 ROLES & RESPONSIBILITIES**

People Leaders shall:

- Ensure that workers (employees and contractors) under their control are aware of and comply with this Standard.

- Ensure that all required atmospheric monitoring resources are readily available for Enbridge employees or made available for contract employees per the Contract; and
- Ensure that workers are trained before using atmospheric monitoring and/or sampling equipment.

Workers shall:

- Inspect, calibrate, bump test, and operate all atmospheric monitoring equipment as per manufacturer's specifications.
- Ensure all training requirements are up to date; and
- Follow site emergency response procedures as appropriate upon atmospheric monitoring equipment alarm.

Safety Team shall:

- Provide timely advice, support, and assistance to People Leaders in the implementation of this Standard; and
- Perform spot checks on gas monitoring equipment to ensure field compliance to the Standard.

Safety Shared Services shall:

- Responsible for the maintenance and continuous improvement of this Standard.

## **6.0 STANDARD-SPECIFIC REQUIREMENTS**

### **6.1 PORTABLE ATMOSPHERIC MONITORING AND SAMPLING – GENERAL REQUIREMENTS**

Monitoring and sampling shall be completed on a frequency as determined by the project safety plan, the Site Safety Plot Plan, and/or a hazard risk assessment. The risk assessment should take into account the presence and potential for a hazardous atmosphere and the degree for which a hazardous atmosphere could generate in the work area during work activities. Areas with significant risk (a "higher" likelihood of a hazardous atmosphere developing) would require a higher frequency of monitoring to the extent that each worker would require an individual gas monitor and area monitoring/sampling as needed.

Unless the results of the risk assessment or hazard assessment determine that there is not a presence or a potential for a hazardous atmosphere, Personal gas monitors shall be used in fenced operating facilities (with the exception of administrative buildings and parking lots), hazardous or restricted areas, or within 30 m of a ground disturbance.

Due to the higher likelihood and the severity of a hazard, the following areas or work activities shall require a written monitoring plan (this can be included on the Field Level Hazard Assessment) that shall include either area or personal monitors where use and frequency is determined per a hazard assessment.

- Working in confined spaces where there is the potential for a hazardous atmosphere,
- Removing storage tank seals, tank manways or tank mixers,
- Entering tanks that have not been cleaned and freed of gas,
- Work associated with open systems, such as scraper traps and provers,
- Spill or leak containment, clean-up, and repairs,
- As required by Regional Operations as noted on the Safe Work Permit (SWP),
- When required based by a hazard assessment, and
- Where the potential for an IDLH atmosphere exists.

Personal monitors shall:

- Be used according to manufacturer specifications,
- Be worn in the breathing zone when used to monitor a worker,
- Not be placed into shirts, coveralls, or jacket pockets unless the pockets are specifically designed to hold portable gas monitors (i.e., mesh pocket), and
- Be recharged in a safe area, away from the area being monitored.

Employees shall know the limitations of the monitoring equipment used. Of special emphasis are the common limitations during cold weather operation. Of special note:

- Most manufacturers of gas detectors place the design lower limit at -10 to -20 °C (14 to -4 °F)
- Liquid Crystal Display (LCD) screens will dim at temperatures from -15 to -25°C (5 to -13 °F). Keeping the monitor inside your coat and attaching a pump will allow you to still read the screen.
- The chemical reactions that occur in the gas detector begin to slow down at temperatures below -20°C (-4 °F) longer monitoring is required to get a good reading.
- Use of a hand warmer in the gas detector carrying case will help speed the reactions slightly, they will keep the LCD screen reading longer and they will help speed up the chemical reactions.
- At temperatures below -35°C (-31°F), it is recommended to take a sample to the gas detector in a warm well-ventilated building.

Personal monitor use during escort - a personal monitor may be used on a person and for other individuals (when/where a monitor is required); when they are being escorted for the purposes of site tours, “walk arounds” or tasks requiring minimal to no hazards in the general area. The individual is to remain in close proximity of the escort at all times.



---

**Area monitors use:**

Area monitors can be used to supplement the need for personal monitors where personal monitors are not mandated per Section 6.1 or based on Atmospheric Monitoring and the Hazard Assessment.

**Contractor Additional Requirements:**

Contractors shall provide appropriate Atmospheric Monitoring and detection equipment unless otherwise noted within the bid documents or at the Request for Proposal (RFP), or at the pre-job meeting.

When necessary, specific atmospheric hazard measurement devices shall also be provided by the Contractor, e.g., if mono-styrene, acetone, benzene, or other hazards are present. Enbridge shall inform the Contractor when there is the potential for respiratory hazards or contaminants that may not be detectable by standard 4 contaminant monitors.

**Alarm Events**

The following actions shall take place when a monitor alarms indicating a potentially IDLH condition ("High" Alarm) in the work area:

- Workers shall place their work in a safe condition, notify workers working in their immediate area of the alarm and exit the space or work area,
- An accounting of all employees shall be completed to verify that all workers have safely exited the work area,
- Initial air monitoring procedures shall be completed prior to re-entry into the work area or space, and
- The source causing the alarm shall be investigated, and the source either eliminated or controlled prior to re-entry. Note that in confined spaces the permit may need to be reissued; refer to the confined space standard.

**6.1.1 PERSONAL AND AREA GAS MONITOR DEVICE REQUIREMENTS**

**Alarm Set Points**

The alarm set points of gas monitors shall be set in accordance with Table 1 (exception: where manufacturer recommendations, local regulations, and/or local safety representative input dictates otherwise).

**Table 1-Portable Gas Monitor Alarm Set Points**

	<b>H<sub>2</sub>S</b>	<b>LEL</b>	<b>CO</b>	<b>O<sub>2</sub></b>
<b>low alarm</b>	10 ppm	10% LEL	25 ppm	19.5%
<b>high alarm</b>	20 ppm	20% LEL	100 ppm	23.5% (US) 23% (Can)

Safety (the local safety representative for Enbridge (Safety Advisor or Safety Inspector)) shall be consulted prior to changing the above set points due to abnormal work situations where the set points need to be expanded.

**Personal Gas Monitors**

Personal gas monitors shall:

- Have 4-head functionality - O<sub>2</sub>, CO, LEL and H<sub>2</sub>S,
- Provide a visual and audible alarm that is equipped with low and high alarm points.

**Area Monitoring**

A personal gas monitor may be used (in a limited capacity) to monitor an area for potential contaminants. In general, the monitor (when used) should be used conservatively; where it would predict worst case conditions of a worker if the worker were to be in that general area (i.e. remote sampling a confined space with a pump attached to the monitor, monitoring the face of an open pipe to represent worst case conditions).

**Area Monitor**

An area monitor is a gas monitor designed to be and work in a fixed location over a period of time and provide early warning to workers. To best represent worker exposure the monitor is positioned in the environment in such a way to represent the worker's breathing zone during the work activities and in general is located nearer to the hazard than the workers to provide early warning.

Area monitors shall:

- Be capable of monitoring the potential atmospheric hazard,
- Be equipped with a visual alarm,
- Be equipped with an audible alarm, and
- The initial hazard assessment and scope of work shall determine the use of area monitors in addition to personal monitors; Examples of where the use of area monitors should be considered:
  - Confined spaces

- Open systems
- Venting systems
- Leak sites
- Hazardous Areas
- Restricted Areas
- When actively working within 30m (100ft.) of Ground Disturbance work which is taking place within 3m (10ft.) of operating facilities (e.g., gas or oil pipelines, above or below ground); in such cases, there shall also be continuous gas monitoring, as determined by the Hazard Assessment

## **6.2 SAMPLING EQUIPMENT**

Sampling equipment shall:

- Be capable of sampling according to the potential hazard, and
- Be positioned within 1 meter (3 feet) of the work area and not interfere with the task, including:
  - At the source of the gas or vapor,
  - Low areas (for petroleum vapors and hydrogen sulphide), and
  - The most representative location for workers at the site.

When using grab sampling equipment such as detector tubes (e.g., Drager CMS) and photo ionization detectors (e.g., UltraRAE) workers shall:

- Obtain multiple grab samples to obtain representative exposure information,
- Always follow standard guidelines for testing time limits and specifications as defined by the manufacturer, testing laboratory, or the United States National Institute of Occupational Safety and Health Analytical Methods Guidelines, and
- If alarms are activated indicating potentially dangerous levels of a chemical prior to specified length of time for measurement being completed, follow guidance under the section "Alarm Events".

## **6.3 INITIAL ATMOSPHERIC MONITORING**

Initial atmospheric monitoring shall be completed when the initial hazard assessment identifies the potential presence of atmospheric hazards in the work area. When Enbridge employees shall be completing work or doing work in an area with a contractor, an Enbridge representative shall complete and document the initial atmospheric monitoring. If the contractor is solely doing the work, the contractor shall ensure that initial atmospheric monitoring is completed and documented. Documentation of completion of the monitoring shall be made available to an Enbridge representative upon request.

Respiratory Protection Equipment (RPE) Requirements:

RPE requirements for initial atmospheric monitoring shall include a Self-Contained Breathing Apparatus (SCBA) when one of the following conditions has the potential to exist in the work environment:

- The work environment is an untested confined space and requires the worker to enter and test the space (note, refer to the specifics in the confined space standard, remote testing prior to entry is the preferred method of testing the air quality of a confined space prior to entry),
- There is an unknown hazardous chemical or contaminant,
- There is an oxygen deficient atmosphere, and
- There is a known hazardous chemical or contaminant with the potential to produce an IDLH atmosphere.

RPE requirements for “routine” tasks or work environments (non-SCBA) completed on a reoccurring basis or for initial monitoring purposes of those tasks, shall be determined based on past Industrial Hygiene (IH) monitoring and/or risk assessments; where it is determined that a potential IDLH atmosphere will not occur.

During initial atmospheric monitoring workers shall document the initial atmospheric monitoring results on the SWP, and if required based on the Hazard Assessment, document continuous Atmospheric Monitoring on the SWP at intervals determined by the Hazard Assessment

Prior to performing any work, Workers shall conduct a minimum of one atmospheric test as needed for chemicals that may be of concern with the product per reference to the Safety Data Sheet (SDS). For example, when benzene is of concern conduct a minimum of one atmospheric test for benzene with a grab sampling instrument or Photo Ionization Detector (PID).

Atmospheric tests shall be taken at the downwind side regardless of the atmospheric tester/operator position relative to the Open Systems

Atmospheric Monitoring for mercaptans with grab sampling equipment shall be completed when there is a presence of coker naphtha products.

#### **6.4 BUMP TESTING, CALIBRATION, AND MAINTENANCE OF EQUIPMENT**

Workers shall follow manufacturer’s specifications regarding servicing, bump testing and calibration.

Calibration and bump tests shall be documented either manually (tags) and/or electronically (device software). Documentation shall clearly identify the date and time that the instrument was calibrated, bump checked, or serviced and shall be retained according to Enbridge record retention policy.

Specific calibration gases used shall be determined based on the type of device, manufacturer recommendations, and the chemical being monitored. When selecting a calibration gas other than

those recommended by the manufacturer, a gas that will produce a more conservative result (errors by overestimating exposure) shall be selected (ask the local Safety Advisor/IH for advice prior to selecting a non-manufacturer recommended calibration gas)

Contractors shall maintain bump test and calibration logs while working at Enbridge and make the logs available at the request of Enbridge.

Bump Testing:

- Bump tests shall be performed in accordance with the manufacturer's specifications and/or more often as needed (where there are errors with the device or operational drift), and
- Instruments that fail a bump test, shall be given and pass a full calibration before using it.

Calibration:

- Calibration shall be completed at the frequency indicated in the manufacturer's specifications,
- Instruments that fail a full calibration shall be tagged as defective and removed from service; and
- A tag (or label) shall be attached detailing the calibration record for multi-gas monitors and grab sampling equipment when shared with a group of Workers.

## **6.5 TANK LOT ENTRY**

Personnel and vehicles entering and working in tank lots must:

- Complete a field level hazard assessment on the work being performed.
- Perform a check to verify a safe atmosphere before entry for work in the tank lot.
- Perform continuous monitoring.

NOTE: Tank lots can be entered regardless of the tank activities as long as entry onto the tank floating roof (internal or external floating) is not required.

## **7.0 TRAINING**

Workers who have been determined to perform atmospheric monitoring duties within their job role will be required to take the training that at a minimum encompasses the following elements:

- Functional bump testing and calibration of instruments,
- Multi-head gas detectors/personal gas detector usage,
- Instantaneous grab sampling equipment,

- Instrument service logging,
- Operational use as per the manufacturer's specifications, and
- Limitations of personal gas monitors.

Reference the Health & Safety training syllabi and matrices for further information and training re-certification requirements.

## **8.0 RELATED DOCUMENTS**

N/A

## **9.0 STANDARD REVIEW**

A subject matter expert (SME) will perform a technical review of this standard every two years to determine the accuracy of the content/information. The SME shall solicit input from applicable stakeholders to ensure the effectiveness of the standard. Any suggested changes must be reviewed and approved by the designated document owner.

## **10.0 REFERENCES**

Occupational Safety and Health Administration (OSHA)

- 1910.1000 Subpart Z Toxic and Hazardous Substances
- 1910.134 Respiratory Protection
- OSHA Technical Manual

Canada Labour Code, Part II; Canadian Occupational Safety & Health (COSH) Regulations,

- Part 10 Hazardous Substances
- 12.13 Respiratory Protection

International Safety Equipment Association

- Statement on Validation of Operation for Direct Reading Portable Gas Monitors

National Fire Protection Association

- NFPA 30 Flammable and Combustible Liquids Code



---

## CHANGE LOG

	Version 2.0	Version 2.1
All Sections		Clerical corrections including spelling and grammar.

<End of Document>



---

# Standard

---

## Aviation – Personal Safety

---

**Effective Date:** 2019-10-31  
**Version #:** 2.1  
**Version Date:** 2024-03-14

---





This page intentionally left blank



**Document Version Register**

<b>Version Number</b>	<b>Version Date</b>	<b>Approved By</b>	<b>Section Number and Title</b>	<b>Details of Version</b>
1.0	2019-03-30	Sean Evans	Whole Document (New Standard)	This is the new H&S standard that was developed as part of the LP   MP Safety Manual Transition Project
1.1	2019-10-31	Sean Evans	3.0, Prerequisites	Updated titles
1.2	2020-06-01	Sean Evans	2.0	Alignment with Contractor Safety Specifications
2.0	2022-01-17	Murray Evenson	6.3 - Helicopter Long Lining Activities 6.3.1 – How to Approve HLL 9.0 – Standard Review	Updated standard with heli long lining activities and updated standard review section
2.1	2024-03-14	Troy Croft	All	Clerical corrections

**Uncontrolled Copy if Printed or Downloaded**



This page intentionally left blank

---

## Table of Contents

1.0	Purpose .....	3
2.0	Scope .....	3
3.0	Prerequisites.....	3
4.0	Definitions and Acronyms.....	4
5.0	Roles & Responsibilities.....	4
6.0	Standard-Specific Requirements .....	6
6.1	Pre-Flight Briefing.....	6
6.2	Helicopters.....	7
6.2.1	Operational Hazards.....	7
6.2.2	Planning For Helicopter Operations .....	8
6.2.3	Staging Locations .....	8
6.2.4	Personal Protective Equipment .....	9
6.2.5	Ground Crew Communication Requirements.....	10
6.2.6	Entering A Helicopter.....	11
6.2.7	Exiting A Helicopter .....	11
6.2.8	Entering Or Exiting A Hovering Helicopter .....	12
6.2.9	Helicopter Fueling Considerations.....	12
6.3	Helicopter Long Lining Activities.....	13
6.3.1	How to Approve HLL.....	14
6.3.2	Slinging Operations .....	15
6.3.3	Lifting Requirements.....	16
6.3.4	Spotter Requirements For Helicopter Lifts .....	18
6.4	Unmanned Aircraft Systems.....	19
6.4.1	Operational Hazards.....	19
6.4.2	Planning for UAS Operations .....	19
6.4.3	Personal Protective Equipment .....	20
6.4.4	Crew Communication Requirements.....	20
6.4.5	Spotter (Visual Observer) Requirements.....	21



---

6.5	Transport Of Hazardous/Dangerous Goods By Air .....	21
6.6	Emergencies .....	22
7.0	Training Requirements .....	22
8.0	Related Documents .....	22
9.0	Standard Review .....	23
10.0	References .....	23
	Change Log .....	23

## **1.0 PURPOSE**

The purpose of this standard is to ensure that Enbridge workforce and contractors are using best in class safe work practices while working with helicopters or fixed winged aircraft and unmanned aircraft systems (UASs).

## **2.0 SCOPE**

This standard applies to all LP Operations and Projects employees completing work activities for LP involving helicopters, fixed winged aircraft, or UAS within projects or operations. This includes line inspections, emergency response activities, transportation of materials or any other activities involving hands on work within or around aircraft including an Enbridge employee or contractor providing an aircraft operator with specific instructions or direction for work related purposes.

The Enbridge Aviation Department flight crews follow the governing aviation authority safety policy and regulations while performing their duties. If this standard conflicts with the governing aviation authority, regulations shall take precedence. For UAS operations, refer to the UAS specific SOP document for further safety information that is not covered within the personal safety standard.

Use of commercial airlines is not within scope for this standard.

This standard does not replace or supersede the Enbridge Safety Standards for Charter Air Carriers document.

Contractors and subcontractors shall comply with Enbridge health and safety requirements set out in this standard, as articulated within applicable contractor safety specifications. If a contractor or subcontractor has a health and safety standard or policy materially different from Enbridge's, the contractor/subcontractor shall follow the most stringent requirement. Contractors and subcontractors are still obligated to meet the requirements of all applicable laws related to this standard.

In the event a contractor's or subcontractor's standard exceeds the requirements of this standard, Enbridge may, in its sole discretion, choose to adopt the contractor's or subcontractor's standard for any given contract or work order.

## **3.0 PREREQUISITES**

Emergency Preparedness – Personal Safety Standard

Enbridge Safety Standards for Air Carriers

Hazard Assessment & Control Standard

Hoisting & Rigging Standard

Safe Work Permit and Work Authorization Standard

Safety Meeting, Tailgate & Toolbox Talks Standard

UAS Standard Operations Manual (For UAS work only)

## **4.0 DEFINITIONS AND ACRONYMS**

*ASL* – Approved Supplier List

*Aviation Authority*—means the civil aviation authority (Transport Canada in Canada or the Federal Aviation Administration in the US) in the country in which the operator or contractor is based and providing services.

*Aviation Regulations*— means the rules prescribed by the governing aviation authority which apply to aviation services being conducted by a carrier.

*Carrier*—means a commercial charter air carrier who has been authorized by the appropriate Aviation Authority to provide flight operations for compensation, hire, or reward.

*ELT*—Emergency Locator Transmitter

*FAA*—Federal Aviation Administration

*Flight Crew*—the person or persons responsible for the control and operation of the aircraft and its intended flight.

*HLL*—Helicopter Long Lining

*IATA*—International Air Transport Association

*PPE* – Personal Protective Equipment

*RPAS*—Remotely Piloted Aerial / Aircraft System

*UAS*—Unmanned Aircraft System

*UAV*—Unmanned Aerial Vehicle

## **5.0 ROLES & RESPONSIBILITIES**

People Leader shall:

- Ensure employees and contractors are familiar with this standard or have a standard that meets or exceeds the expectations of this document,
- Ensure or facilitate that appropriate work planning has been completed prior to helicopter operations, and
- Ensure the appropriate level of approval is completed for the Helicopter Long Lining activity.

Workers shall:

- Support the development and execution of the field level hazard assessment for all work to be completed as well as the expectations within this standard.

Rigger shall:

Note: this role is performed by flight crew members including the pilot depending on the work activity and/or the aviation company/carrier's policies and procedures. There may be opportunities where Enbridge personnel or contractors will support this work activity and may be responsible for the expectations listed below. Prior to work execution, they must receive training from the flight crew members. The pilot in command has final authority as to who rigs loads and how a load is rigged. When rigging personnel are provided by the carrier, Enbridge personnel will not be responsible for the duties listed below and will be present only to oversee operations and coordinate the lifts with the carrier's employees:

- Be trained for rigging helicopter loads and for overhead crane loading including load preparations, securement and procedures as per local/applicable legislation and/or carrier requirements,
- Inspect the safety devices of all rigging equipment or installed rigging devices on equipment to be lifted. Only the pilot in command or flight crew members shall test the lifting equipment and ensure it meets legislative and engineering requirements,
- Have experience consistent with the requirements of the lift to be made,
- Be physically and mentally able to accomplish required rigging tasks,
- Perform visual equipment inspections of rigging equipment to ensure cleanliness and that it is in good condition; remove all equipment from service that does not meet visual inspection until it can be verified to be in safe working condition in accordance with the manufacturer's specifications, and
- Maintain a written record or log book of these inspections when applicable.

Spotter/signal person shall:

Note: The spotter's role may be performed by flight crew members depending on the work activity and/or the aviation company/carrier's policies and procedures. When spotter/signal person personnel are provided by the carrier, Enbridge personnel will not be responsible for the duties below and will be present only to oversee operations and coordinate the lifts with the carrier's employees.

- Be familiar with helicopter lift hand signals and consult with the pilot in command on his/her preference for hand signal use,
- Complete any specific training required by applicable legislation and/or as required by the company in charge of the lift. Consult with the pilot in command to ensure operations are understood and that requirements are clear,



- Wear appropriate PPE to distinguish themselves from other workers,
- Supervise the landing/loading area(s) to ensure personnel do not enter the area while lifts are happening and halt operations if an unauthorized entry is made,
- Observe and communicate on the movement of the load or communicate any other information the pilot in command may need to know by either hand signals or radio, and
- Ensure no personnel are stationed in the flight path of a suspended load taking-off and/or being landed.

Helicopter pilot shall:

- Be familiar with the requirements of this standard along with the safety standards for charter air carriers.

Visual observer (UAS):

- Review the *Visual Observer Briefing* document and communicate any concerns directly with the pilot verbally,
- Follow the instructions of the pilot in command at all times, and
- Assist the pilot with keeping the landing/take-off area clear when not required to be observing the UAV or during emergencies.

UAS pilot:

- Ensure that you have reviewed the *Visual Observer Briefing* with your visual observer and that they clearly understand their role, and
- Ensure that you have established a communication protocol with the visual observer.

## **6.0 STANDARD-SPECIFIC REQUIREMENTS**

A documented field level hazard assessment must be completed between the pilot and designate ground crew for work activities using a helicopter for long-lining or other material transportation requirements.

Prior to entering any aircraft, ensure the pilot provides an orientation on the safety features of the helicopter or plane and discusses operational hazards and emergency procedures specific to the aircraft being used.

### **6.1 PRE-FLIGHT BRIEFING**

The pilot or flight crew shall conduct a thorough and documented passenger briefing with all passengers before their first flight, which includes, as a minimum, the following:

- Procedures for boarding and exiting the aircraft including any dangers associated with the aircraft type,

- Training on safe use and the dangers of the improper use of the aircraft's equipment, if passengers will use the doors, cargo compartments or helicopter basket,
- Potential dangers of the turning main rotor and turning tail rotor when applicable (in the case of helicopters),
- Potential dangers of jet engines or turning propellers when applicable (in the case of fixed wing aircraft),
- Location and use of emergency and lifesaving equipment required to be carried, such as, life preservers, life-raft, portable fire extinguishers, first-aid kits, and survival gear,
- Location and explanation of the proper use of the emergency locator transmitter (ELT), and
- SMOKING is NOT permitted on any Enbridge flight.

## **6.2 HELICOPTERS**

### **6.2.1 OPERATIONAL HAZARDS**

The greatest hazards associated with helicopters are the spinning main and tail rotor blades, the exhaust and the downwash. Spinning helicopter rotor blades can be difficult to see and may vary in their height above the ground. In addition, they create a strong rotor downwash, produce high noise levels and can generate static electricity. When on or near the ground, the helicopter produces downwash that can recirculate air as well as foreign objects back down through the main rotor systems. Loose objects must be secured on the ground to prevent them travelling through the main or tail rotor which can cause loss of control of the helicopter and lead to catastrophic mechanical damage as well as injuries up to and including death. The downwash is capable of knocking a person over. It can also dislodge vegetation, objects or debris which may pose a threat either to people on the ground or to the helicopter itself.

Helicopter rotor blades can generate static electricity. In moist or dry snow air conditions, static electricity can build up on the helicopter. This static electricity will be discharged when the helicopter contacts ground or any of the helicopter attachments come into contact with the ground. This is not a hazard to those on the helicopter unless a passenger steps down from a hovering helicopter, which creates a path to ground.

Static electricity shock is a threat to workers who come into contact with the aircraft or with its attached sling gear before the charge has had a chance to dissipate; allowing the aircraft longline or sling gear to touch the ground before handling it will dissipate the charge to ground and can eliminate the risk of electric shock.

---

## **6.2.2 PLANNING FOR HELICOPTER OPERATIONS**

In planning the layout of a work site, the following minimum information must be considered when developing the pre-job or project plan:

- Planned approach and departure paths with consideration of prevailing wind patterns and built-up areas if applicable (i.e., departure or approach near homes or farms with livestock),
- Location of work areas for the various elements of the operation,
- Location of emergency landing areas,
- Location of landing areas,
- Location of separate service and refuelling areas,
- Location of any travelled roadways, and
- Location of any potential hazards such as power lines or tall trees.

Workers must be informed of the work plan as well as the helicopter flight path to and from the helipad and/or landing zones. Flight paths and operational areas must be kept clear of equipment or personnel other than the flight personnel necessary to assist in landing and take-off.

Workers must not be placed in an area where there are overhead hazards.

## **6.2.3 STAGING LOCATIONS**

When determining the location(s) for staging lifting operations or medical evacuation helipad sites, there are several best practices to incorporate prior to commencing operations.

### **6.2.3.1 General**

Landing sites must have sufficient clearance for the main and tail rotors. Landing sites are to be on level ground with less than 5% slope and at least 36 X 36 meters (120 X 120 feet). This area will need to be expanded for use of multiple or larger helicopters and if the location is to be used as a staging site for fueling and/or lifting operations.

If applicable, road blocks will be required approximately 500 meters (1650 feet) on either side of the landing site.

Loose materials, garbage and other debris must be removed from the site or secured appropriately.

A windsock must be located in a location that is visible to the pilot.

---

### **6.2.3.2 Medical Evacuation Staging Sites Training**

Note: Enbridge Aviation and contracted air carrier staff are not qualified to provide anything more than first aid assistance for emergency medical evacuation if no other options are available.

This section provides the general information that a contracted air emergency medical services provider would require to support any medical evacuation requirements for a region or project.

Ensure that all landing sites designated for medical evacuation are registered with the appropriate emergency response provider in the region or project area.

When registering a landing site or calling for a medical evacuation, be prepared to provide the following information:

- Location site number (if previously registered with the response provider),
- Legal land description and GPS coordinates,
- Contact person and phone number at the location site,
- Known hazards on the site location,
- Confirmation of an on-site monitor for H<sub>2</sub>S and other potential respiratory hazards on site as applicable, and
- Confirmation of landing zone markings required for day and night landings.

See the *Emergency Preparedness (Personal) Standard* for additional requirements specific to emergency response planning.

### **6.2.4 PERSONAL PROTECTIVE EQUIPMENT**

When working with helicopters, ground crews are required to wear the following personal protective equipment:

- Approved safety footwear,
- High visibility garment,
- Approved hard hat with a chin strap,
- Face shield or safety goggles where dust and flying debris may be present,
- Hearing protection, and
- Hand protection (avoid use of gauntlet gloves as they can be snagged by rigging).

It is recommended that the ground crew also have clothing that provides suitable protection against the weather.

Workers travelling inside a helicopter must use the headsets attached to the intercom system of the helicopter (if provided), so the pilot in command can communicate with them. This will

require that hardhats are removed so that headsets can be worn. When headsets are not provided, appropriate hearing protection is required.

Workers travelling to remote sites (helicopter access only) in the helicopter must ensure that they have the necessary communication, high visibility clothing, survival and first aid gear with them to survive in case the helicopter becomes unserviceable or cannot return to pick them up (if dropped off) due to weather or other problems.

### **6.2.5 GROUND CREW COMMUNICATION REQUIREMENTS**

Good communication between the pilot and the ground crew is vital for carrying out helicopter operations in a safe and efficient manner. Before helicopter operations begin, the supervisor and ground crew must meet with the pilot in command to establish:

- Plans and procedures to be used,
- Ground-to-helicopter communication systems,
- Corrective measures required to minimize risks of injury to workers,
- Limitations and capabilities of the helicopter, and
- Guidelines for the safe use of equipment associated with the helicopter operation.

Communication between the pilot and ground crew should be established by implementing the following minimum requirements:

- Established effective system of visual communication signals between the pilot and the ground crew (noise may prevent verbal communication),
- If available, two-way radio communication equipment shall be tested and the channels to be used established before operations begin. This is essential for helicopter operations,
- Established exact voice or hand signal commands to avoid any possibility of misunderstanding; all communication should be pertinent and brief,
- If two-way communication is available, include helicopter identification in any command given to direct flight movement,
- A distinctive high-visibility vest or jacket to be worn by the worker who is in radio contact with the pilot,
- Clearly marked location of cables and all known hazards in the way of anticipated flight paths on the plans, and make the pilot aware of them, and
- Confirmed visual and verbal signals will be used before starting the operation.

Please see section 6.3.4 for more information on visual signals for helicopter operations.

---

## **6.2.6 ENTERING A HELICOPTER**

Passenger entry and exit will only be completed when the aircraft rotor system is either stopped or is running at 100 percent. No passenger movement will be allowed while the aircraft rotor system is starting or stopping. No passenger shall board the helicopter if they have not had the pilot briefing or are not familiar with the specific helicopter.

If entering while the helicopter is running, establish contact with the pilot. Position yourself where the pilot can see you. Maintain visual contact with the pilot (wear goggles if dust is a hazard).

After being signaled by the pilot, approach the helicopter in the preferred direction (i.e., from the front within line of sight of the pilot) if possible. Walk, do not run. Enter the helicopter one person at a time. NEVER approach from behind the helicopter because of the risk of being struck by the tail rotor, or being burnt by exhaust. In addition, the pilot cannot see you.

If the helicopter is on a slope, approach from the downhill side. Never approach from uphill descending down toward the helicopter.

If blinded by swirling dust or grit, STOP, crouch low and wait for assistance (if it is safe to do so).

Approach the helicopter in a crouching manner for extra rotor clearance. NEVER reach up to grab clothing or other articles that have blown away.

Do not grab any part of the aircraft unless it is a door handle, if you grab or touch antennas or flight control instruments you may be hurt or possibly damage the aircraft (e.g. pitot tubes are normally VERY hot and will burn you instantly if you touch them).

Carry any tools or equipment horizontally below waist level—NEVER upright or on your shoulder.

NEVER BRING BEAR SPRAY INTO A HELICOPTER. If you must carry it for work purposes, notify the pilot and ensure that it is stored properly for transport as per the pilot's directions.

Once you have reached the helicopter, you will be instructed where to sit. Once seated, fasten and adjust your seatbelt. Ensure that the door is properly closed behind you. When you are seated, with seat belt fastened, and the door has been closed, let the pilot know that you are ready for flight.

## **6.2.7 EXITING A HELICOPTER**

Passenger entry and exit will only be completed when the aircraft rotor system is either stopped or is running at 100 percent.

If you must exit while the helicopter is running remain seated, with seatbelts fastened until instructed by the pilot to disembark.

On exiting the helicopter, remain beside the helicopter (within the pilot's line of sight if possible and very close to the helicopter) until all passengers have disembarked; ensure that: doors are

closed properly; any external cargo has been collected; and the cargo compartments are properly closed. Training on proper use of doors and the cargo compartments will be done by the pilot-in-command in the pre-flight briefing.

Exit the helicopter to the front, staying within the pilot's line of sight. Remember to exit in a downhill direction, if possible, and to crouch when under the rotor diameter. If the passengers are not able to get outside the rotor diameter after exiting the helicopter, a plan will be discussed with the pilot in command with a procedure that will be followed for the departure.

Once all passengers are outside the rotor diameter (if possible) and have reached a safe area, one designated person should signal the pilot that he is clear to leave (this should be a signal that is discussed and agreed upon in the pre-flight briefing). Before giving the signal for the pilot to depart, the designated signaling person will scan the area for any potential hazards that may be present (i.e., garbage, unsecured cargo, forgotten cargo, doors not closed etc.).

Ensure that you are wearing your PPE when the helicopter departs; if you are close to the helicopter, there will be a very strong wind blast as well as sand/dirt/grit flying around, so eye protection is important, and crouching is advised to maintain balance.

These procedures shall be discussed in detail with the pilot in command if the helicopter is going to be running when the passengers get out. A rehearsal of the event before departure (with the helicopter stopped) may be conducted so that everyone is clear of their responsibilities.

## **6.2.8 ENTERING OR EXITING A HOVERING HELICOPTER**

This procedure is an extremely high-risk operation and should only be used in cases where no other entry/exit options exist.

Anyone who will be exiting or entering the helicopter while hovering will be trained in this procedure by either a trained and endorsed pilot or by a training center. Training for hover exit/entry will be conducted prior to anyone performing this operation in a field location and proof of current training made available.

## **6.2.9 HELICOPTER FUELING CONSIDERATIONS**

Only the pilot is allowed to remain in the helicopter during refueling. The helicopter shall be electrically bonded to the bulk fuel tank, barrel or vehicle during refueling. Refueling will only be accomplished with the helicopter engine shut down and the rotor stopped. "Hot" or engine running refueling is not authorized.

The flight crew is the only personnel who can assist or perform fueling duties.

At least one 20BC minimum rated portable fire extinguisher shall be in the immediate area.

No smoking or spark producing activity shall be permitted within 15.2 meters (50 feet) of fuel storage barrels or refueling operations.

---

Fuel storage location sites must meet or exceed all local environmental, health and safety requirements within the project or regional operating area.

Housekeeping of fueling sites during operations must be maintained to the highest level; downwash can cause lighter items to move and become hazardous to both the helicopter and ground crew. For example, empty drums should be stored away from the landing area and spill containment berms that hold fuel barrels must be sufficiently weighted to hold them down.

#### Fixed Wing Aircraft

When approaching and departing from a fixed wing aircraft stay in the pilot's field of view at all times. Approach only when the pilot indicates that it is safe to do so.

Caution: The safety zones for approaching a fixed wing aircraft are different than for helicopters. Never approach the airplane while running unless instructed to do so and shown safe approach angles.

Always beware of the propellers, particularly when engine(s) is idling during warm up and brief stops to load or unload passengers, materials or equipment. Never touch the propeller of a reciprocating/piston engine aircraft as the engine can turn over if the ignition switches are left on or are faulty. Never touch any part of the airplane unless instructed to do so by a crew member.

The pilot is responsible for correct weight and balance of the aircraft. Only assist with loading heavy or bulky equipment or materials under the pilot's supervision.

### **6.3 HELICOPTER LONG LINING ACTIVITIES**

Helicopter long lining activities require the appropriate level of approval, dependent on the following risk matrix:



CARRIER	LOAD	TERRAIN	APPROVAL LEVEL (RAPID)	POTENTIAL SEVERITY LEVEL
<ul style="list-style-type: none"> <li>ASL Approved Contractor</li> <li>ENB Aviation, up to date pre-qualification</li> <li>Demonstrated Pilot Competency Program</li> <li>Below the hook rigging training</li> <li>Issued lift plan catalogue</li> <li>Pre-flight HLL checklist</li> <li>Focused Inspection</li> <li>Work Practice Evaluation</li> </ul>	<ul style="list-style-type: none"> <li>Load design and implementation meets all criteria of approved HLL lift plan</li> </ul>	<ul style="list-style-type: none"> <li>No exposure to the public</li> <li>No flight path over man made structures</li> <li>Low complexity terrain (elevation, congestion, pick up and drop zones)</li> <li>No flight path over operating facilities</li> </ul>	D =Supervisor	Less than P2
<p><b>Carrier or Load</b> not meeting above criteria. Mitigation plan required to bring into tolerances</p>			D=Manager R= Aviation I = Safety	P2
<p><b>More than one</b> category requires mitigation *Note: loads over population or operating facilities require Director level authorization due to reputational risk to ENB</p>			D =Director R = Aviation, Safety or VP	P3 & higher

### 6.3.1 HOW TO APPROVE HLL

#### 6.3.1.1 Less Than P2 = Supervisor Authorization

Carrier + Load + Terrain is optimal, no deviation from optimal work design with mitigations in place that are as low as reasonably practicable

- Carrier – meets ENB Aviation specifications, produces pilot competency, plans the lift and designs the assigned work as per their work practice
- Load – the object(s) to be transported are of a known weight and lift configuration, an appropriately approved lift plan is documented and transported successfully before
- Terrain – the flight path does not lift over people, operating facility of 3rd party infrastructure

#### 6.3.1.2 P2 = Manager Authorization

Terrain is optimal but a deviation is required for the Carrier or Load criteria

- Carrier – is sole sourced and only contractor available in the location, requires mitigation in order to meet standards
- Load – no pre-determined lift plan produced by the carrier or load doesn't meet all the criteria of a carrier plan

### **6.3.1.3 P3 or Higher = Director Authorization, VP is informed**

More than one criteria requires a deviation for the Carrier, Load or Terrain criteria.

\*Note: loads over population or operating facilities require Director level authorization due to reputational risk to ENB.

Additional requirements for safe Long Lining practices are outlined in the Enbridge Safety Standards for Air Carriers.

### **6.3.2 SLINGING OPERATIONS**

Workers working around helicopters during slinging operations shall:

- Keep the area free of loose articles,
- Watch for hazards, such as obstacles or hanging trees that may fall when dislodged by the helicopter rotors or by gusty wind conditions,
- Stay alert and be aware of the positioning of loads,
- Maintain visual contact with the load (and cargo hooks) until it clears the location,
- Keep a safe distance from the loads,
- Remain clear of incoming loads (and cargo hooks) until they are placed on the ground,
- Determine an escape route that leads away from the load, and ensure it remains clear of objects or potential blockages,
- Always stand uphill from the load, as it may roll when released, and
- Maneuver the load only when absolutely necessary and only by pushing it into position; do not reach for a load or cargo hook.

For all helicopter lifts, the minimum control measure required shall be a field level hazard assessment (FLHA) that addresses:

- Expectations and responsibilities of all parties involved with the slinging operation,
- Identified traveled path(s) of the helicopter,
- Hazards and controls associated with the work area,
- Identification of the designated riggers and spotters/signal person to other workers involved,

- Agreed upon lift hand signals,
- Agreed upon means of communication between the pilot and rigger/ spotter/signal person,
- Lift zone and all potential drop zones, and
- The requirement to not walk or pass under a suspended load or enter the area between the load and a stationary object.

Drop zones or landing areas should be sufficiently large enough in order to prevent equipment from contacting trees or other obstructions while spotting or lifting.

Note that for all long line activities, ground personnel must keep a minimum 200 foot (61 meter) safety zone from the helicopter while it is lifting or landing a load at a staging site. This distance may need to be increased based on the length of the long line being used. The safety zone is determined by multiplying the long line length by 2X. This requirement must be documented within the field level hazard assessment prior to work commencement.

Landing areas shall be constructed with adequate blade clearance, proper footing for the type of helicopter being used, and include consideration for the direction of approach the passengers will use if loading is conducted with the helicopter running. They also should be located in a manner so the helicopter can always lift 'into the wind direction'.

The carrier shall conduct on-the-job safety meetings and crew briefings on a regular and scheduled basis.

### **6.3.3 LIFTING REQUIREMENTS**

The pilot in command must be consulted and authorize all lifts including set up of the loads and the rigging of the lifts.

Note: The air carrier is responsible for providing all lifting equipment for helicopter operations. When inspecting an air carrier's equipment, Enbridge in no way assumes responsibility for the serviceability/safety of that equipment. These inspections and instructions are only provided as an added level of safety, so Enbridge employees have a better level of understanding of the equipment. The aim of these recommendations is that an Enbridge employee would feel informed and confident enough to question the air carrier on the condition of their equipment.

For slinging and/or helicopter lift operations, follow these recommendations:

- Use only purpose-built helicopter longlines which can be made from various materials from synthetic fabrics to steel,
- All long lines and lanyards must be in good condition and not show signs of excessive wear. Normally long lines will have a metal tag indicating the year of manufacture, manufacturer and load limitations. Any doubt on condition is to be addressed with the pilot in command and lifts are not to be authorized until serviceability can be assured,

- Lanyards or endless straps will have tags or a sewn-on information decal indicating useful load, manufacturer and date of manufacture. Consult with the pilot in command if there is any doubt of the condition of any equipment used in helicopter lifting operations. If there is any disagreement on condition of the equipment, do not authorize the lift until all doubt of condition of the equipment has been removed,
- Attach only properly-sized clevises or pear rings, with the proper weight rating to the helicopter hook (either the belly hook or the extended hook) and keep all screw-type clevis pins tight and a safety device installed (i.e., lock wire, ty wrap, etc.),
- Use only the proper type of clevis pins (not bolts) and visually check clevises before and after each lift,
- If the carrier does not already have a record keeping system in place, record the equipment inspections,
- Visually inspect cargo nets for condition. Excessive fading, lack of identification tags, broken strands, and excessive wear caused by excessive use or age are cause for rejection of the net. No lifts are to be conducted if the serviceability of the net cannot be assured,
- Secure loads of loose articles in cargo nets,
- Advise the pilot of the presence of any hazardous materials,
- Do not conduct long line operations over populated areas,
- Do not conduct long line operations within 100 m (110 yd.) of high-voltage power lines,
- Cease operations during electrical storms,
- Ground all loads to prevent a buildup of static electricity (static prevention is meant to prevent possible electrical injury to spotters),
- Before commencing slinging operations, designate one person as the spotter and if two-way radio communication is available, ensure that radio frequencies are established.
- No Enbridge workers shall be passengers or deemed essential crew during lift operations,
- All clevises on auxiliary equipment shall be secured (i.e., safety pin, lock-wired or tie- wrapped) in order to prevent inadvertent release,
- All auxiliary equipment (hooks, line, clevis, etc.) shall be visually inspected prior to use and thereafter on a regular basis,

- The line attached to any helicopter hook, either belly mounted or remote, shall be fitted with a properly sized clevis or ring and have no more than one (1) lanyard attached (i.e., multiple-hook sling loads shall NOT be attached directly to the helicopter hook),
- Any external load that has the possibility of turning in flight shall be fitted with a ball-bearing swivel and be fitted with a drogue chute or similar device to control directional stability of the load,
- Complex lifting devices (i.e., carousel, bag-runner, extended electric hook) shall have detailed inspection procedures, including a documented annual inspection.

#### **6.3.4 SPOTTER REQUIREMENTS FOR HELICOPTER LIFTS**

The spotter is the only person permitted to stand beneath the helicopter during slinging operations unless another person is required to help position the load.

The spotter is the only person permitted to use hand signals.

The spotter shall:

- Use standard hand signals (or signals discussed with, and agreed to in advance by the pilot in command) when the helicopter is operating directly overhead and when it is impossible to use radio communication,
- Confirm that the pilot has visual contact of the spotter by radio prior to using hand signals,
- Be in constant radio communication with the helicopter pilot whenever possible,
- Ensure standard helicopter hand signals are practiced and agreed upon prior to the start of operations,
- Use large movements when using hand signals, especially when using long lines,
- Wear head protection with chin strap,
- Wear protection from static (e.g., high-voltage gloves) during cold weather/low humidity,
- Wear eye and ear protection appropriate for the task, and
- Wear a distinctive high-visibility vest or jacket to distinguish themselves from other workers.

The following standard hand signals shall be confirmed with the pilot and spotter prior to work execution and utilized appropriately during all lifting or slinging operations:

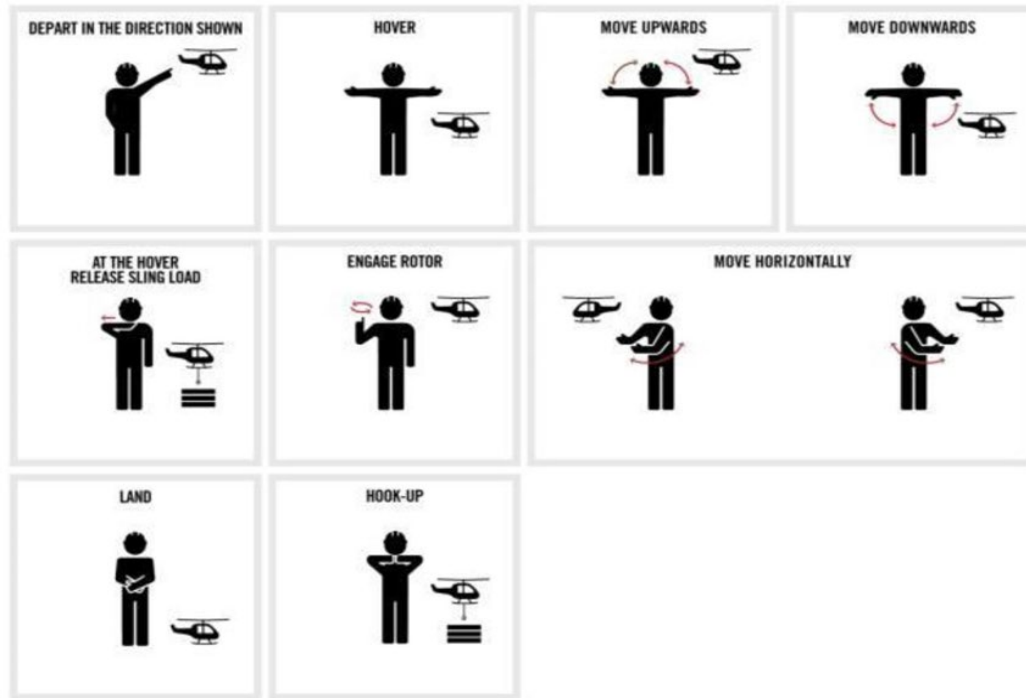

## 6.4 UNMANNED AIRCRAFT SYSTEMS

Unmanned aircraft systems present a unique environment for personal safety that touches both traditional aviation and ground based operations personal safety.

### 6.4.1 OPERATIONAL HAZARDS

UAVs have high RPM plastic or carbon fibre propellers that can cut human flesh to the bone in an instant. Do not approach a UAV unless the pilot advises that the controls are secure and that it is safe to approach. The landing/take off area for the UAV will be clearly delineated with cones and appropriate signage. UAS may quickly return to land if a loss of communications occurs. Listen to the instructions given by the pilot in command and ensure you stay clear of this area.

Do not stand beneath a hovering UAV. A battery failure could cause the UAS to drop very rapidly and strike a person on the ground.

Lithium Polymer (LiPo) batteries must be protected from physical damage and the contacts protected from short circuit. These events can cause very intense fires that are difficult to extinguish with traditional methods.

### 6.4.2 PLANNING FOR UAS OPERATIONS

In planning the layout of a work site, the following minimum information must be considered when developing the pre-job or project plan:

- Planned take off/landing areas and approach/departure paths with consideration of prevailing wind patterns, mechanical turbulence, built up areas, and obstacles if applicable (i.e., departure or approach near homes or farms with livestock),
- Location of work areas for the various elements of the operation,
- Location of emergency landing areas,
- Location of landing areas,
- Location of any travelled roadway,
- Location of any potential hazards such as power lines, buildings, structures, or tall trees, and
- Known sources of potential radio interference (EMI/RFI).

Workers must be informed of the work plan as well as the helicopter flight path to and from the helipad and/or landing zones. Flight paths and operational areas must be kept clear of equipment, or personnel other than flight personnel necessary to assist in landing and take-off.

Workers must not be placed in an area where there are overhead hazards.

Detailed UAS operations planning for pilots can be found in the Enbridge UAS Operations Manual.

### **6.4.3 PERSONAL PROTECTIVE EQUIPMENT**

When working with UAS, the pilot and visual observer are required to wear the following personal protective equipment:

- Approved safety footwear,
- Class 2 HVSA to distinguish themselves from other workers,
- Approved hard hat with a chin strap,
- Face shield or safety goggles where dust and flying debris may be present, and
- First Aid kit.

It is recommended that the pilot and visual observer also have clothing that provides suitable protection against the weather.

### **6.4.4 CREW COMMUNICATION REQUIREMENTS**

Good communication between the pilot and the ground crew is vital for carrying out helicopter operations in a safe and efficient manner. Before UAS operations begin, the visual observer, supervisor and workers involved in the operation must meet with the pilot in command to establish:

- Plans and procedures to be used,

- Corrective measures required to minimize risks of injury to workers,
- Limitations and risks associated to the UAS,
- Communication between the pilot and ground crew should be established by implementing the following minimum requirements:
  - Establish an effective system of voice communication signals between the pilot and the visual observers/ground crew (noise and distance may prevent verbal communication),
  - If available, two-way radio communication equipment shall be tested and the channels to be used established before operations begin. This is essential for UAS operations where direct verbal communications is not possible,
  - Establish exact voice or hand signal commands to avoid any possibility of misunderstanding: all communication should be pertinent and brief,
  - Clearly mark location of cables and all known hazards in the way of anticipated flight paths on the plans, and make the pilot aware of them.

#### **6.4.5 SPOTTER (VISUAL OBSERVER) REQUIREMENTS**

The visual observer is an integral part of the UAS ground crew. Their role is to keep the pilot informed of other aircraft that could potentially enter the UAS flight operations area and to advise the pilot of any hazards that the UAV may be getting too close to or have the potential to cause a flight safety occurrence.

The visual observer shall:

- Remain within direct voice contact with the pilot at all times (by radio if remaining in close proximity to the pilot is not possible while performing their duties),
- Maintain visual contact with the UAS at all times with no exception, and
- Not perform any other duties other than those detailed in the Visual Observer Briefing. They must not be distracted by other workers or activities that would take attention away from their primary duties. It only takes a few seconds for a UAS to come in contact with an obstacle when operating in complex environments.

#### **6.5 TRANSPORT OF HAZARDOUS/DANGEROUS GOODS BY AIR**

Enbridge Aviation does not transport hazardous/dangerous goods by air. If using a contracted carrier, the carrier must, at all times, hold the appropriate approval from the aviation authority in order to transport hazardous or dangerous goods by air for Enbridge.

In the absence of aviation regulations that set a more stringent standard, the carrier must accept, handle, load, and transport hazardous or dangerous goods in compliance with the IATA Regulations (International Air Transport Association).



The pilot in command **MUST** be informed of any dangerous goods cargo before the start of the flight.

Lithium Polymer (LiPo) batteries used in UAS are considered dangerous goods. Check with the UAS program manager if you are not sure if a particular UAS or UAS battery can be shipped or transported by air and what paperwork may be required.

## **6.6 EMERGENCIES**

During an emergency, follow any instructions issued by the pilot.

Check that any loose gear in the cabin is secured and put on a helmet if provided. Remove eye glasses and put them in your pocket. Loosen your collar and assume the brace position.

Tighten your seat belt.

- With shoulder straps: tighten and sit upright, knees together, arms folded across your chest.
- Without shoulder straps: bend forward so your chest is on your lap, head on knees, arms folded under thighs.

In the case of a UAV Fly-Away, maintain visual contact as long as possible while noting the height, direction of travel and the speed of the UAV.

If the UAV strikes the ground after a flight accident, keep the area around the UAV clear due to the LiPo battery fire hazard. Do not approach or touch the UAV. The pilot will initiate the emergency response plan and advise further action.

## **7.0 TRAINING REQUIREMENTS**

Personnel working in the field must be knowledgeable in this Standard and may be assigned applicable training as driven by the Safety Training Matrix.

Reference the Health & Safety training syllabi and matrices for further information and training re-certification requirements.

## **8.0 RELATED DOCUMENTS**

Safety Standards for Charter Air Carriers

Safety Standards for Air Carriers

UAS Standard Operations Manual

Long Line HTA Approval Request Template

Focused Inspection Report – Helicopter Operations

Work Practice Evaluations – Helicopter Safety

## 9.0 STANDARD REVIEW

A subject matter expert (SME) will perform a technical review of this standard every two years to determine the accuracy of the content/information. The SME shall solicit input from applicable stakeholders to ensure the effectiveness of the standard. Any suggested changes must be reviewed and approved by the designated document owner.

## 10.0 REFERENCES

Occupational Safety and Health Administration (OSHA) Act

- Section 5, Duties

Canada Labour Code, Part II:

- Canadian Occupational Health & Safety Regulations, Hazard Prevention Program; Part XIX

Federal Aviation Administration:

- Part 133 External Load Operations
- Part 133 Operations

ASME B30.12-2011 Handling Loads Suspended from Rotorcraft

## CHANGE LOG

Section	Version 2.0	Version 2.1
Entire document		Clerical corrections including spelling and grammar.

<End of Document>



---

# Standard

---

## Bloodborne Pathogens Exposure Control

---

**Effective Date:** 2019-03-30

**Version #:** 1.4

**Version Date:** 2024-03-28

---



This page intentionally left blank



**Document Version Register**

Version Number	Version Date	Approved By	Section Number and Title	Details of Version
1.0	2019-03-30	Sean Evans	Whole Document (New Standard)	This is the new H&S standard that was developed as part of the LP   MP Safety Manual Transition Project
1.1	2020-06-01	Sean Evans	2.0	Alignment with Contractor Safety Specifications
1.2	2021-06-01	Murray Evenson	8.0 9.0	Added Record Retention Criteria Updated section 9 to reflect the appropriate review process
1.3	2023-04-18	Murray Evenson	6.1	Removed requirement for combination eye shield and mask
1.4	2024-03-28	Troy Croft	1.0, 2.0, 4.0, 6.3, 6.4, 6.5, 6.6, 6.6.1, 7.0, 11.2	Alignment with Management System Framework – Event Analysis
			All	Clerical corrections



This page intentionally left blank

---

## Table of Contents

1.0 Purpose .....	2
2.0 Scope .....	2
3.0 Prerequisite .....	2
4.0 Definitions and Acronyms.....	2
5.0 Roles & Responsibilities.....	3
6.0 Standard – Specific Requirements.....	4
6.1 Preventative Measures.....	5
6.2 Decontamination.....	6
6.3 Disposal.....	7
6.4 Hepatitis B Vaccination.....	8
6.5 Post Exposure Medical Evaluation & Follow-up.....	8
6.6 Medical Records.....	9
6.6.1 Analysis Report.....	10
7.0 Training Requirements .....	10
8.0 Related Documents & Record Retention .....	11
9.0 Standard Review .....	11
10.0 References .....	11
11.0 Appendix.....	12
11.1 Appendix 1 – Sample of Declination or Acceptance of the HBV Vaccine Form .....	12
11.2 Appendix 2 – Sample of Post Exposure Evaluation and Follow-Up Checklist.....	13
Change Log.....	14

---

## 1.0 PURPOSE

This standard provides information covering the control plan to be followed to minimize employee exposure to blood, body fluids visibly contaminated with blood, and any other potentially infectious body fluids. It also details the requirements to be followed in the event of an exposure event.

## 2.0 SCOPE

This standard applies to any employee who makes the determination to provide first aid where there is a potential exposure to blood or body fluids. First aid is considered a collateral duty of trained staff. Employees that may respond to injuries resulting from workplace events are included within the scope of this document.

Contractors and subcontractors shall comply with Enbridge health and safety requirements set out in this standard, as articulated within applicable contractor safety specifications. If a contractor or subcontractor has a health and safety standard or policy materially different from Enbridge's, the contractor/subcontractor shall follow the most stringent requirement. Contractors and subcontractors are still obligated to meet the requirements of all applicable laws related to this standard.

In the event a contractor's or subcontractor's standard exceeds the requirements of this standard, Enbridge may, in its sole discretion, choose to adopt the contractor's or subcontractor's standard for any given contract or work order.

## 3.0 PREREQUISITE

Emergency Preparedness - Personal Safety Standard

## 4.0 DEFINITIONS AND ACRONYMS

*Blood*—human blood, human blood components, and products made from human blood.

*Bloodborne Pathogens*—pathogenic microorganisms that are present in human blood and can cause disease in humans. These pathogens include but are not limited to the hepatitis B virus (HBV) and the human immunodeficiency virus (HIV).

*Contaminated Laundry*—laundry that has been soiled with blood or other potentially infectious materials.

*Decontamination*—the use of physical or chemical means to remove, inactivate, or destroy bloodborne pathogens on a surface or item to the point where they are no longer capable of transmitting infectious particles and the surface or item is rendered safe for handling, use, or disposal.



*Exposure Event*—a specific eye, mouth, other mucous membrane, non-intact skin, or parenteral contact with blood or other potentially infectious materials that results from the performance of an employee's duties.

*Handwashing Facilities*—a facility providing an adequate supply of running potable water, soap, and single-use towels or air-drying machines.

*HBV*—hepatitis B virus.

*HIV*—human immunodeficiency virus.

*Licensed Healthcare Professional*—a licensed physician or other licensed health care professional whose legally permitted scope of practice allows him or her to perform the activities of Hepatitis Vaccinations and post-exposure evaluation and follow-up independently.

*OPIM*—other potentially infectious material.

*Personal Protective Equipment (PPE)*—specialized clothing or equipment worn by an employee or contractor for protection against a bloodborne pathogen hazard.

*Regulated Waste*—defined as:

- Liquid or semi-liquid blood or other potentially infectious materials,
- Contaminated items that would release blood or other potentially infectious materials in a liquid or semi-liquid state if compressed,
- Items that are caked with dried blood or other potentially infectious materials and are capable of releasing these materials during handling, and/or
- Any other material containing blood or other potentially infectious materials.

*Source Individual*—any individual, living or dead, whose blood or other potentially infectious materials may be a source of occupational exposure to the employee.

*Universal Precautions*—is an approach to infection control. According to the concept of universal precautions, all human blood and certain body fluids are treated as if known to be infectious for HIV, HBV and other bloodborne pathogens.

## **5.0 ROLES & RESPONSIBILITIES**

People leaders shall:

- Ensure that employees under their control are aware of and comply with this standard.
- Complete defined responsibilities specific to employee vaccination, post exposure evaluations and follow-up requirements.

- Direct employee to ensure that all required documents (including medical records) are forwarded to the designated Human Resources or Health Services personnel to meet document control and retention requirements.

Employees must shall:

- Notify their supervisor immediately if they come into contact with blood or other body fluids through the provision of rendering first aid or through other means while on the job.
- Notify and submit required documentation to the designated Human Resources or health services personnel as directed by people leader or Safety Team.
- Complete any required training in accordance with the Safety Training Matrix and Safety Team.
- Provide timely advice, support and assistance to People Leaders in the implementation of this standard.

Safety Shared Services is:

- Responsible for the maintenance and continuous improvement of this standard.

## **6.0 STANDARD – SPECIFIC REQUIREMENTS**

Universal precautions shall be used by workers who could potentially be exposed to any of the following:

- Blood;
- Bodily fluids containing visible blood;
- Other bodily fluids; and/or
- Used needles, scalpels and other sharp instruments.

Potential routes of exposure include:

- By injection or injury with contaminated injecting equipment (e.g., needle-stick injury) or other sharp objects.
- By transfusion with infected blood or blood products or the transplantation of infected material.
- By indirect transfer of infected blood through shared razors, toothbrushes and other personal items.
- Through mucosal contact (e.g., splashes of body substances to the mouth, nose, eyes or non-intact skin).

If potentially exposed to bloodborne pathogens while on the job, the exposed employee will be given the option to receive a confidential medical evaluation by a licensed healthcare professional. If the exposed employee refuses a medical evaluation, the employee shall not be permitted to continue to provide first aid in the workplace until such time a licensed healthcare professional examines the employee and declares him/her fit to engage in the provision of first aid.

## **6.1 PREVENTATIVE MEASURES**

Universal precautions must be observed when providing first aid or performing other duties, if contact with their blood or body fluids is possible, to prevent contact and potential infection. This includes the use of the following personal protective equipment which includes but is not limited to:

- Disposable non-sterile, latex or nitrile gloves;
- Disposable respirator/eye protection combination; and
- Resuscitation mask/micro-shield.

Examples of conditions warranting the use of this PPE includes, but are not limited to:

- Exposure to blood and other infectious materials;
- Exposure to mucous membrane and non-intact skin;
- Performing mouth-to-mouth resuscitation; and
- Handling or touching contaminated surfaces.

The use of PPE is also required when handling or touching surfaces contaminated by blood or bodily fluids.

Biohazard kits shall be provided in the standard first aid kits. The biohazard kit includes at least one of each of the following:

- Pair of disposable latex gloves (extras should be kept on hand at stations);
- Sanitary hand wipe; and
- One-way valve mask for cardiopulmonary resuscitation (CPR).

A high standard of personal hygiene and the practical application of the steps listed below are essential to preventing infection to first aid responders and personnel requiring care.

- Hands must be washed and dried immediately after removing gloves (gloves cannot be guaranteed to prevent skin contamination and may not remain intact during use).
- Gloves must be removed and replaced when providing first aid to more than one worker.
- Protective eyewear must be worn where eyes and/or mucous membranes may be exposed to splashed or sprayed blood or other body fluids/substances.

- Cuts or abrasions on any part of a worker's body must be covered with appropriate dressings at all times as soon as possible.

A common infection hazard for workers is exposure to sharps (e.g., used needles). Where it has been identified that sharps are present and require appropriate disposal, Enbridge locations shall provide specific containers for safe disposal of sharps.

Ensure the following for safe sharps handling and disposal:

- Used needles shall be safely disposed of in a sharps container.
- Used needles shall not be recapped.
- Sharps containers shall have BIOHAZARD warning signs and labels posted on them. Warning signs shall be fluorescent orange, with lettering and symbols of a contrasting color.
- Sharps containers shall have a clearly defined maximum capacity (i.e., have a fill line that indicates when the container is  $\frac{3}{4}$  full) and shall be sturdy enough to resist punctures under normal conditions of use and handling.
- Sharps containers shall be disposed when they become  $\frac{3}{4}$  full and disposed of in a proper manner (see Disposal).

People Leaders shall ensure that hand washing facilities are readily accessible to workers who may be potentially exposed while providing first aid or medical assistance. If washing facilities are not provided, antiseptic cleansers shall be provided.

## **6.2 DECONTAMINATION**

Examine any equipment and surfaces that may be contaminated (e.g., machines or where an employee has been injured). The preferred method of cleaning is having the employee use an appropriate disinfectant to decontaminate their own blood or OPIM, if they have the ability to do so.

If this option is not feasible, decontaminate any equipment that is found to be contaminated by wiping down or washing using an appropriate disinfectant. Employees completing this task must be trained and wear appropriate PPE.

Contaminated equipment and surfaces must be cleaned with a product registered with the Environmental Protection Agency (EPA) and cleared by the Food and Drug Administration (FDA) or with a mixture of bleach and water. Bleach and water should be mixed to a solution of 1 part bleach per 10 parts water or approximately 1  $\frac{1}{2}$  cups per gallon. The solution needs to be mixed fresh and is only effective for 24 hrs. The surfaces should be sprayed, wiped and allowed to air dry.

It may be necessary to send some equipment out for cleaning (e.g., clothing, etc.).

If the equipment is contaminated with a large volume of blood or OPIM, the people leader must contract appropriate cleanup with a decontamination contractor. If the equipment cannot be cleaned internally or if it needs to be disassembled for proper cleaning:

- Attach an appropriate biohazard label identifying which pieces of the equipment are contaminated and
- Provide all affected employees (i.e., employees who use the equipment, circulate in its proximity, or who clean the equipment and surrounding area, floors, wall, etc.) with information regarding any pieces of equipment that are contaminated.

If the equipment will be shipped to a location outside the facility for servicing, the people leader has a duty to warn all involved employees, equipment service representatives and equipment manufacturer of the potential hazards involved related to bloodborne pathogens.

### **6.3 DISPOSAL**

Contaminated trash (e.g., paper towels or rags) with small amounts of blood or OPIM can be placed in the regular trash containers, provided that the blood or body fluid will not be released from the media if the item is compressed.

If an item is saturated with blood or OPIM, it is not allowed in the regular waste stream. Special arrangements are needed to dispose of this trash (including disposing of sharps container bins). If an EMS service (e.g., ambulance or fire department) is providing medical attention to an employee, see if arrangements can be made to send the biohazard waste from the event with the service provider. Contact your local environmental advisor if this is not possible, and arrangement will be made for disposal.

Containers used for disposing of regulated waste must be:

- Closable,
- Constructed to contain all contents and prevent fluid leakage, and
- Red in color or labeled with a biohazard warning label.

Close both primary containers and secondary containers before handling, shipping or storing.

In the event that a disposal company cannot be found, small amounts of contaminated trash can be decontaminated using the following procedure then disposed of in regular trash containers:

1. Mix 1 part bleach per 10 parts water (approximately 1 ½ cups per gallon).
2. Add contaminated waste to mixture, fully soaking and covering waste.
  - Allow waste to soak a minimum of 12 hours.
3. After 12 hours, pour bleach solution down drain.

4. Rinse waste with water.
5. Allow waste to air-dry.
6. Dispose of decontaminated waste in regular trash containers.
  - Double-bagging and/or labeling is not necessary after proper decontamination.

## **6.4 HEPATITIS B VACCINATION**

Enbridge will pay for vaccination against hepatitis B virus when it has been recommended by an employee's physician following an exposure to potentially infectious materials or as per the direction provided explained below. Due to the relatively low-risk nature of work performed by company employees, pre-exposure vaccinations are not required. Employees perform first aid on a voluntary basis as a collateral duty of their positions.

When an employee cleans up blood, other potentially infectious material or determines the need to render first aid assistance in any situation involving the presence of blood or OPIM, regardless of whether an actual 'exposure event' occurred, the following items must be completed:

- The event must be reported to their people leader as soon as possible but no later than the end of the shift. The information reported must include: the names of all employees that rendered first aid assistance; description, time and date of the event; a determination of whether or not an exposure event occurred,
- The People Leader contacts the Safety Team for guidance on what post-exposure practices or medical follow-up may be necessary, and
- If the employee is unvaccinated, regardless of if an exposure event occurred or not, a provision for the full hepatitis B vaccination series is necessary. This needs to be made as soon as possible after the event occurs but no later than 24 hrs. The employee may decline immunization. In this case, the employee must sign a *Declination or Acceptance of the HBV Vaccine form*. This form will be kept with the employee's personnel file. If an employee changes their mind, they may receive the vaccine or vaccination series.

## **6.5 POST EXPOSURE MEDICAL EVALUATION & FOLLOW-UP**

Any employee who is potentially exposed to bloodborne pathogens while on the job will be given the option to receive a confidential medical examination by a licensed healthcare professional.

The people leader is responsible for the following post-exposure practices and medical follow-up measures:

- Provide the exposed employee with an Event Report form (Encompass) to provide to his/her licensed healthcare professional identifying the routes of exposures and the circumstances under which the exposure event occurred.

- Where the exposed employee' has consented to a medical examination, including the collection and testing of his/her blood, follow up with designated Human Resources or Health Services personnel to confirm that such blood collection and testing of the exposed employee's blood for indications of HBV and HIV has been completed.
- If needed, follow-up with the exposed employee to ensure that the designated Human Resources or Health Services personnel has arranged treatment for the exposed employee for post-exposure prophylaxis (measures designed to preserve the health and prevent the spread of disease).
- Provide the following information to the exposed employee's Licensed Healthcare Professional involved in the medical follow-up of the exposed employee:
  - A copy of the OSHA Bloodborne Pathogens Standard (US ONLY).

The people leader shall follow-up with the exposed employee to ensure that a copy of the Licensed Healthcare Professional's written report regarding potential exposure to HBV or HIV has been provided to the employee following the completion of the medical evaluation. All other medical report findings or diagnoses not related to the potential exposure to HBV or HIV will not be provided to the company and will not be included in the company's internal written report.

A Post-Exposure Evaluation and Follow-Up Checklist (see Appendix) will be completed by the People Leader, Safety Team or other assigned party and submitted to Human Resources or Health Services for document retention.

## **6.6 MEDICAL RECORDS**

Human Resources or Health Services shall retain medical records for each employee with confirmed occupational exposure to bloodborne pathogens for the duration of the employee's employment plus 30 years. The medical record must include:

- Employee name and social security number,
- Record of received HBV vaccinations or records pertaining to the refusal or inability to receive HBV vaccinations,
- A copy of the event report form and any other records the company provided to the exposed employee's licensed healthcare professional as a result of exposure to bloodborne pathogens, and
- A copy of all results of medical examinations, medical testing and follow-up procedures that have been conducted as a result of exposure to bloodborne pathogens while at work.

---

### **6.6.1 ANALYSIS REPORT**

The analysis report of the exposure event shall be retained permanently within Safety Shared Services event records.

## **7.0 TRAINING REQUIREMENTS**

Employees who have been determined to have an occupational exposure risk (are assigned with First Aid training within the Safety Matrix) within their job role will be required to take Bloodborne Pathogen training. US based employees are required to complete this training on an annual basis (regulatory driven). Canadian based employees must take this training every three years.

Training for Bloodborne Pathogen Control must include:

- A general explanation of the epidemiology and symptoms of bloodborne pathogens including HBV and HIV,
- An explanation of the modes of transmission,
- An explanation of the use and limitations of control methods which include universal precautions and PPE,
- An explanation of the basis for selection of PPE, its use, limitations, location, removal, decontamination and disposal,
- Information on the HBV vaccine, including its effectiveness, its safety, the benefits of being vaccinated, method of administration, and that it is offered free of charge,
- An explanation of the procedure for exposure events, including reporting and post-exposure medical follow-up,
- An explanation of the sign, labels, tags and/or color-coding used to identify biohazards, and
- An opportunity for interactive discussion on the subject matter.

Course participants must also have access to a copy of the Bloodborne Pathogens Regulation, OSHA 29 CFR 1910.1030 (US employees only).

Training records for the Bloodborne Pathogens Control Standard shall include the date of the training session; a summary of the training provided; the names and qualifications of persons conducting the training; and the names and job titles of all persons attending the training sessions.



---

## **8.0 RELATED DOCUMENTS & RECORD RETENTION**

- Declination or Acceptance of the HBV Vaccine Form (Retention Duration: Current year +30 years)
- Post Exposure Evaluation and Follow-Up Checklist (Retention Duration: Current year +30 years)

## **9.0 STANDARD REVIEW**

A subject matter expert (SME) will perform a technical review of this standard every two years to determine the accuracy of the content/information. The SME shall solicit input from applicable stakeholders to ensure the effectiveness of the standard. Any suggested changes must be reviewed and approved by the designated document owner.

## **10.0 REFERENCES**

Occupational Safety and Health Administration (OSHA)

- Bloodborne Pathogen Regulation, 29 CFR 1910.1030
- Employee Exposure and Medical Records, 29 CFR 1910.20

Canada Labour Code, Part II:

- Canadian Occupational Safety & Health (COSH) regulations
- National Fire Code, Part 5 (referenced by Canada Labour Code, Part II)

Transportation of Dangerous Goods (TDG) regulations

Workplace Hazardous Materials Information System (WHMIS) regulations

---

## 11.0 APPENDIX

### 11.1 APPENDIX 1 – SAMPLE OF DECLINATION OR ACCEPTANCE OF THE HBV VACCINE FORM

#### ***DECLINATION OR ACCEPTANCE OF THE HBV VACCINE***

"I have been given the opportunity to be vaccinated with the hepatitis B vaccine at no charge to me. I have been fully informed of the risks associated with hepatitis B, and I understand that hepatitis B is a serious disease. However, I decline the hepatitis B vaccination at this time. I understand that by declining this vaccine, I continue to be at risk of acquiring hepatitis B.

\_\_\_\_\_  
*Print Name*

\_\_\_\_\_  
*Date*

\_\_\_\_\_  
*Signature of Employee*

*I accept the opportunity to be vaccinated with hepatitis B vaccine, at no charge to myself.*

\_\_\_\_\_  
*Print Name*

\_\_\_\_\_  
*Date*

\_\_\_\_\_  
*Signature of Employee*

## 11.2 APPENDIX 2 – SAMPLE OF POST EXPOSURE EVALUATION AND FOLLOW-UP CHECKLIST

**CONFIDENTIAL MEDICAL RECORD  
DO NOT FILE DUPLICATE**

The following steps must be taken, and information transmitted in the case of an employee's exposure to Bloodborne Pathogens.

<b>Activity Performed</b>	<b>Completion Date</b>
1. Employee provided documentation regarding exposure event	
2. Exposed employee's blood collected and tested (unless refused)	
3. Opportunity for employee to arrange an appointment with Licensed Healthcare Professional	
4. Documentation forwarded to Licensed Healthcare Professional: <ul style="list-style-type: none"><li>▪ Bloodborne Pathogen Exposure Management Standard and OSHA standard (US only)</li><li>▪ Description of exposed employee's duties</li><li>▪ Description of exposure event, including route of exposure</li></ul>	

\_\_\_\_\_  
People Leader Name (Print)

\_\_\_\_\_  
Signature

\_\_\_\_\_  
Date

## CHANGE LOG

Section	Version 1.3	Version 1.4
Entire Document		Clerical corrections including spelling and grammar.
1.0, 2.0, 4.0, 6.3, 6.4, 6.5, 6.6, 6.6.1, 7.0, Appendix 2		Updated terminology from incident and investigation to event and analysis.

<End of Document>



# Standard

---

## Commercial Motor Vehicle Drivers - Canada

---

**Effective Date:** 2019-10-31

**Version #:** 3.1

**Version Date:** 2024-03-28

---



This page intentionally left blank



**Document Version Register**

Version Number	Version Date	Approved By	Section Number and Title	Details of Version
1.0	2019-10-31	Sean Evans	Replacement in Kind. Information pulled from LP/MP Safety Manual	Changed formatting as a part of the Safety Manual Transition Project.
1.1	2020	Sean Evans	2.0	Alignment with Contractor Safety Specifications
2.0	2021-06-01	Murray Evenson	6.3.1 6.6.1	Added Supporting H&S Programs Added new ELD Section
3.0	2021-10-18	Jeff Safioles	All sections	Complete rewrite of this safety standard
3.1	2024-03-28	Troy Croft	All sections 4.0	Clerical corrections Alignment with Management System Framework - Event Analysis.



This page intentionally left blank



---

## Table of Contents

1.0	Purpose .....	3
2.0	Scope .....	3
3.0	Prerequisites.....	3
4.0	Definitions & Acronyms .....	3
5.0	Roles & Responsibilities.....	7
6.0	Standard-Specific Requirements – Company.....	9
6.1	Safety Fitness Certificates.....	9
6.2	Carrier Profile Monitoring.....	10
6.3	Regulated Vehicles – (Markings).....	10
7.0	Standard-Specific Requirements – Driver.....	10
7.1	Authorized Drivers .....	10
7.2	Driver Qualification, Evaluations and Files.....	11
7.3	DRIVER RECORDS AND RECORD RETENTION.....	13
7.4	Orientation .....	14
7.5	Ongoing Training .....	14
7.6	Safe Use And Operation Of Vehicles .....	14
7.7	Compliance with The Law.....	14
7.8	Drug and Alcohol Policy .....	<b>Error! Bookmark not defined.</b>
7.9	Documentation - Driver Qualification Forms (DQF) .....	16



---

8.0	Training.....	17
9.0	Standard Review .....	17
10.0	Related Documents .....	17
11.0	References .....	17
	Appendix A – Hours of Service .....	19
	Appendix B – Vehicle Maintenance and Inspections .....	28
	Appendix C – Vehicle Recordkeeping .....	31
	Appendix D – Use of Safety Equipment.....	32

---

## 1.0 PURPOSE

The purpose of this standard is to ensure that Enbridge workforce and contractors use accepted means when operating Company owned, rented, or leased commercial motor vehicles.

## 2.0 SCOPE

This standard applies to employees who operate Company owned, rented, or leased commercial motor vehicles.

Drivers based in Canadian Provinces that also operate into the United States must meet U.S. driver qualification requirements as specified in the US based Commercial Motor Vehicle (DOT) Drivers (US) procedure.

Contractors and subcontractors shall comply with Enbridge health and safety requirements set out in this standard. If a contractor or subcontractor has a health and safety standard or policy materially different from Enbridge's, the contractor/subcontractor shall follow the most stringent requirement. Contractors and subcontractors are still obligated to meet the requirements of all applicable laws related to this standard.

In the event a contractor's or subcontractor's standard exceeds the requirements of this standard, Enbridge may, in its sole discretion, choose to allow the contractor or subcontractor to use their standard for any given contract or work order.

## 3.0 PREREQUISITES

Directly related to Hours of Service are key H&S program expectations. These expectations are found in the Environmental Conditions Standard and the Fatigue Management Standard. Expectations that should be understood and coordinated with hours of service include:

- Complete Journey Management planning when required as outlined in the Environmental Conditions Standard (when workers are travelling more than 2 continuous hours).
- When applicable, working alone practices should be implemented as outlined in the Environmental Conditions Standard
- Utilize or develop Fatigue Management plans when expecting hours of service could impact performance.

## 4.0 DEFINITIONS & ACRONYMS

According to the regulation(s):

*Accident* – An unexpected event which results in damage or injury.

*Act* – The Motor Vehicle Safety Act

*Adverse Driving Conditions* – Snow, sleet, fog, other adverse weather conditions, a highway covered with snow or ice, or unusual road and traffic conditions, none of which were apparent on the basis of information known to the person dispatching the run at the time it was begun.

*Air brakes* – A vehicle with an air brake system has brakes that are initiated by air pressure from an engine-driven compressor. This sends air pressure through a series of hoses, reservoirs, and control valves to all the vehicle's brakes.

*Carrier* – An owner of a commercial vehicle in respect of which a certificate is issued or who holds a certificate or is required to hold a certificate.

*Client Information Center (CIC)* – 3rd party vendor's comprehensive web-based compliance resource used to maintain driver qualification files.

*Commercial Driver* – A driver who operates a Company owned, rented, or leased vehicle that meets the definition of a commercial motor vehicle. (May vary based upon Provincial or Federal requirements.)

*CMV* – Commercial Motor Vehicle

*Commercial Vehicle* – Commercial Vehicle means a vehicle that is used for the transportation of goods or passengers and that is:

- Alberta
  - Provincial status (within Alberta only): Registered weight of 11,794 kilograms or more.
  - Federal status (operate outside of Alberta): Registered weight 4,501 kilograms or more.
- British Columbia
  - Truck or truck tractor with a licensed gross vehicle weight exceeding 5,000 kilograms (including the weight of an attached trailer).
- Manitoba
  - A regulated vehicle is a commercial truck, limited-use commercial truck, self-propelled public service vehicle, limited-use public service vehicle, school bus, or other motor vehicle that meets either or both the following criteria:
    - Its registered gross weight is 4,500 kilograms or more; or
    - It is designed for carrying 11 persons or more, including the driver.
- New Brunswick
  - A commercial vehicle that has a gross mass of 4,500 kilograms or more.
- Newfoundland/Labrador

- 
- A truck, tractor, or trailer, or combination of them, exceeding a registered gross vehicle weight of 4,500 kilograms.
  - Northwest Territories
    - A truck, truck-tractor, or trailer or a combination of a truck or truck-tractor and one of two trailers, where the gross weight of the motor vehicle or the combination of motor vehicle exceeds 4,500 kilograms.
  - Nova Scotia
    - A truck, truck-tractor, trailer, or a combination thereof that has a registered gross vehicle weight of more than 4,500 kilograms.
  - Ontario
    - Vehicle with a gross weight or registered gross weight of more than 4,500 kilograms and tow trucks regardless of weight.
  - Prince Edward Island
    - Vehicles with a gross mass exceeding 4,500 kilograms or more.
  - Quebec
    - Vehicle with a gross mass weight rating of 4,500 kilograms or over.
  - Saskatchewan
    - Vehicles registered in Class A, C, or D and that have a registered gross weight of 5,000 kilograms or more, or
    - Vehicles that are registered in Class LV (commercial use only) and that have a registered gross weight of 11,794 kilograms or more, or, if operated outside of Saskatchewan, with a registered gross weight of 5,000 kilograms or more.
  - Yukon Territory
    - Trucks, tractors, or trailers, or any combination of these vehicles, that have a registered gross vehicle weight exceeding, or that weight more than, 4,500 kilograms.

**CVOR** – Commercial Vehicle Operators Registrations

**Daily Trip Inspection** – A daily trip inspection of a truck, truck-tractor or trailer or a bus other than a motor coach.

**Driver** – Any person who drives a commercial motor vehicle.

**Driving or Drive** – Includes having the care or control of a vehicle.

**Driving Record** – A record of all the information that relates to an individual driver's history.

---

*ELD* – Electronic Logging Device

*Goods* – Any thing or load that is or may be carried by means of a vehicle.

*Major Defect* – The condition of an item specified as a major defect in Schedule 1, 2, 3 or 4 of National Safety Code Standard 13, Part 2.

*MVR* – Motor Vehicle Record

*NSC* – National Safety Code

*Notice of Defect* – A notice issued by a manufacturer, distributor or importer of a vehicle as prescribed by the Motor Vehicle Safety Act (Canada).

*Off-Duty Time* – The time during which a driver is not on on-duty time or is in the sleeper berth of the commercial vehicle.

*On-Duty Time* – The time that begins when a driver commences work or is required by the carrier to be available to work and that ends when the driver stops work or is relieved of responsibility by the carrier and includes driving time and time spent by the driver doing any one or more of the following:

- Inspecting, servicing, repairing, conditioning or starting a commercial vehicle;
- Travelling in the commercial vehicle as one of two drivers, when that driver is not resting in the sleeper berth;
- Participating in the loading or unloading of a commercial vehicle;
- Inspecting or checking the load of a commercial vehicle;
- Waiting, at the request of the carrier by whom the driver is employed, for a commercial vehicle to be serviced, loaded or unloaded;
- Waiting for a commercial vehicle or load to be inspected at a customs office or weighing checkpoint;
- Travelling as a passenger in a commercial vehicle, at the request of the carrier by whom the driver is employed, to a destination where the driver will commence driving time, where the driver has not had eight consecutive hours of off-duty time immediately prior to commencing driving time;
- Waiting because of an accident or other unplanned occurrence or situation;
- Resting in or otherwise occupying a commercial vehicle, except time spent resting in a sleeper berth;
- Performing any other work as, or at the request of, a carrier;
- Performing any work for compensation for a non-carrier entity

*Owner* – The person who owns a vehicle and includes any person renting a vehicle or having the exclusive use of a vehicle under a lease that has a term of more than 30 days or otherwise having the exclusive use of a vehicle for a period of more than 30 days.

*Personal Conveyance* – The movement of a CMV for personal use while a driver is off duty that does not benefit the company financially.

*Principal place of business* – The place or places designated by the motor carrier where daily logs, supporting documents and other relevant records required by the Commercial Vehicle Drivers Hours of Service Regulations are kept. **Enbridge's' location has been identified as 10175 101 Street, Edmonton, AB T5J 0H3**

*Semi-Trailer* – A trailer that:

- Has axles only at or near its rear end;
- While being towed, is supported at its front end by the truck tractor or the immediately preceding trailer; or
- When connected to the truck tractor or preceding trailer, is connected by means of a kingpin and a fifth wheel.

*Towed Vehicle* – A motor vehicle being towed by a commercial vehicle.

*Towing Vehicle* – A commercial vehicle towing a motor vehicle.

*Trailer* – A vehicle without motive power that is designed to be towed by another vehicle and as defined in the Commercial Vehicle Dimension and Weight Regulation.

*Truck* – A motor vehicle designed and intended for the transport of goods or carrying of loads and as defined in the Commercial Vehicle Dimension and Weight Regulation.

*Truck-Tractor* – A truck designed primarily for drawing other vehicles and not constructed for carrying any load other than a part of the weight of the vehicle and load drawn, and includes a tractor as referred to in National Safety Code Standard 13 or a vehicle designed to accept a fifth wheel coupling, but does not include a crane-equipped breakdown vehicle.

## **5.0 ROLES & RESPONSIBILITIES**

People Leaders shall:

- Ensure all employees driving commercial motor vehicles comply with this procedure.
- Not knowingly allow, require, permit, or authorize any employee whose license has been revoked, suspended, canceled, or disqualified to drive a motor vehicle until such license has been reinstated.
- Not allow unqualified drivers to drive a commercial motor vehicle.

- Consult with HR to determine if driving conviction placed driver in a High-Risk category that could necessitate the need to complete a Driver Improvement Plan or other disciplinary action(s)
- Ensure Hours of Service (HOS) duties and responsibilities are followed.
  - Verification that all authorized drivers have a record for every calendar day (including days off and holidays).
  - Verification that all authorized drivers understand and apply the appropriate hours of service regulations.
  - Check all authorized drivers for form and manner violations every day. This includes checking for name, address, date, daily hour totals, and odometer readings on the record.
  - Check all authorized drivers for fatigue-related violations (see list of fatigue-related violations in Appendix A).
  - Use independent supporting documents (that cannot be created or modified by the driver) to verify the accuracy of each driver's records. Supporting documents may include fuel receipts, bills of lading with shipping times, GPS records, or meal/hotel receipts, toll receipts, etc.
  - When violations are identified in a driver's records, take appropriate remedial action. All action(s) taken must be documented and must include the date the violation was identified, and date issue was addressed.
- Ensure Vehicle Maintenance requirements are met as outlined in Appendix B.
  - Ensure drivers comply with vehicle maintenance requirements. See appendix
  - Certify all repairs or corrections and return all roadside inspections reports within 15 days of the inspection. (Forward copy to Fleet Safety)
- Work with drivers to ensure Vehicle Records requirements are met as outlined in Appendix C
- Ensure drivers adhere to requirements regarding Safety Equipment as outlined in Appendix D.
- Ensure drivers receive remedial training as needed to address vehicle maintenance violations.
- Review/Submit all required driver qualification/documentation.

Drivers (Employees):

- Shall not drive a commercial motor vehicle unless they are licensed and qualified to drive that vehicle.
- Shall follow all laws, rules, and company policies.
- Are prohibited from the following:
  - Having more than one license.



- Utilizing a radar detector while operating a commercial motor vehicle.
- Allowing passengers (non-company) employees to ride in vehicle without approval from their People Leader.
- Utilizing a mobile telephone or texting while operating a commercial motor vehicle.
- Will utilize their collision avoidance skills by managing their speed and space management.
- Shall ensure vehicle maintenance is adhered to including the following:
  - Drivers will not operate an unsafe vehicle until it has been repaired and documented for major and minor issues.
  - Drivers will consult with People Leader to address matters related to the maintenance of vehicles.
  - Drivers will report results of all roadside inspections to their People Leader within 24 hours.

Safety and Fleet Departments shall:

- Obtain a safety fitness certificate
- Monitor Enbridge's Carrier Profiles
- Keep abreast of changes with Authorities and Jurisdictions
- Ensure the demographic information is correct (name, address, number of drivers, number of vehicles, etc.);
- Review the risk factor (R Factor) Score to ensure it is not increasing.
- Review the convictions to identify trends or patterns; for example, drivers with repeated convictions/citations, convictions of regulations (particularly in the same area of a regulation), or repeated traffic violations;
- Ensure that collision information is accurate; and
- Review Commercial Vehicle Safety Alliance (CVSA) inspections and identify if vehicles or drivers are being put out-of-service.
- Maintain all CMV driver qualification documentation in a secured area, limiting access.

Safety Management Systems shall:

- Be responsible for the maintenance and continuous improvement of this Standard.

## **6.0 STANDARD-SPECIFIC REQUIREMENTS – COMPANY**

### **6.1 SAFETY FITNESS CERTIFICATES**

Enbridge is required to obtain a safety fitness certificate from their base-plated province in order to operate on Canadian roads.

The requirements apply to carriers operating extra-provincially that are either:

- Trucks, tractors, or trailers, or any combination, that exceeds 4,500 kilograms.

The regulations require provinces to track the safety performance of where carriers are based within a province. The safety profile contains various types of safety-related information such as

reportable accidents, safety convictions and violations, and facility audit results. Enbridge must maintain a safety rating of satisfactory or satisfactory-unaudited. Conditional or unsatisfactory will not be tolerated.

## **6.2 CARRIER PROFILE MONITORING**

Enbridge will obtain the profiles every six months. The Safety Department will review Enbridge carrier profile(s) to:

- Confirm that safety policies and procedures are effective;
- Identify potential trends in transportation safety non-compliance;
- Implement corrective actions and retraining, if needed; and
- Ensure accuracy of information reported on the carrier profile.

## **6.3 REGULATED VEHICLES – (MARKINGS)**

Enbridge is a “Federal” status carrier, which means that our vehicles may cross into other provinces.

Note: Athabasca Region has a Provincial Operating Status Safety Fitness Certificate which means that vehicles over 4500 kg do not cross into other provinces.

Enbridge will place a copy of its safety fitness certificate in all commercial motor vehicles. Enbridge will not operate its commercial vehicles on a highway unless the following are displayed on the driver and passenger sides of the vehicle in letters and numbers at least 50 millimetres in height and in a color contrasting with the background:

- The owner’s name or logotype;
- The vehicle’s empty weight; and
- The vehicles licensed maximum gross weight.

## **7.0 STANDARD-SPECIFIC REQUIREMENTS – DRIVER**

### **7.1 AUTHORIZED DRIVERS**

Only drivers authorized by their People Leaders are permitted to operate commercial motor vehicles.

All authorized drivers must follow the procedures found in this safety program. By following the policies in this program, all authorized drivers will be more aware of how to operate safely.

All individuals that operate a motor vehicle on behalf Enbridge are required to maintain a valid driver’s license. In Canada, driver’s licences are issued by the government of the province or

territory in which the driver is residing. Thus, specific regulations relating to driver's licences vary province to province, though overall they are quite similar.

Any loss of license must be reported immediately to the appropriate People Leader.

## **7.2 DRIVER QUALIFICATION, EVALUATIONS AND FILES**

### **Driver Qualifications**

When hiring a new driver, the People Leader ensures the driver is qualified for the job by reviewing the driver's commercial driver abstract. By reviewing the commercial driver abstract, the People Leader will ensure the driver has a valid operator's license for the class of vehicle he/she will be operating.

Eligibility includes the following:

- Verify applicant meets age regulated by province
- Pass a Medical Fitness test
- Cannot have a GDL (Graduated Drivers' License)
- Drivers must have only one valid driver's license issued by a Provincial authority.

### **Driver Application (APP)**

- Application completed when hired.

### **Employment History**

- The employment history for the 3 years immediately preceding the time the driver started working for Enbridge.
- Employment verification form can be completed if driver has been employed by Enbridge 3 or more years.

### **Yearly Review; Identified as Annual Review/Certification of Violations – (ARCV)**

- A record of the driver's convictions of safety laws relating to the operation of a motor vehicle in the current year and each of the three preceding years.

### **Driver Abstracts**

- Driver's abstract within 30 days of hire.
- Drivers abstract annually thereafter.
- For Alberta only, verify a current medical certificate is included.

### **Driver's License (DL)**

- A legible copy of both front and back

### **Driver Convictions / Administrative Penalties**

### **Collisions**

- 
- When received, the documentation for a collision that occurred within the last 3 years will be imaged using the date of the collision as the pre-index date.

**Transportation of Dangerous Goods Certificate**

- Image certificate and establish expiration date for future notification of expiring renewable document.

**Training Certificates – All Others**

- Image any other training certificate, such as coupling/uncoupling, forklift, or power lift, that have an expiration date within the last 3 years.

---

## **7.3 DRIVER RECORDS AND RECORD RETENTION**

### **Driver Files**

Enbridge keeps a driver record for every person authorized to operate regulated company vehicles, including owner(s) and management. These driver records include the following information:

- The driver's completed application form for employment (note: the driver's resume is an acceptable application);
- The driver's employment history for the three years immediately preceding the time the driver started working for Enbridge, where applicable;
- A copy of the driver's abstract when the driver is first hired or employed, dated within 30 days of the date of employment or hire;
- Annual updated copies of the commercial driver's abstract;
- A record of the driver's convictions of safety laws in the current year and in each of the 4 preceding years;
- A record of any administrative penalty imposed on the driver under safety laws;
- A record of all collisions involving a motor vehicle operated by the driver that are required to be reported to a peace officer;
- A record of all training undertaken by a driver related to the operation of a commercial vehicle and compliance with safety laws;
- A copy of any training certificate issued to the driver, in electronic or paper form, for the period starting on the date the training certificate is issued and continuing until 2 years after it expires, in accordance with Part 6.6 of the Transportation of Dangerous Goods Regulations under the Transportation of Dangerous Goods Act, 1992; and ;
- A copy of a current medical certificate as required by provincial regulations.

### **Driver Record Retention**

Enbridge will keep all driver files at the principal place of business or electronically through a third-party provider. These records will be:

- Updated with new driver abstracts on an annual basis;
- Updated with driver training certifications as needed;
- Retained for at least five years from the date they are created, established, or received (unless specified otherwise by specific legislation); and
- Available for inspection by a peace officer during our regular business hours.

### **Driver Training**

Enbridge will ensure all drivers have met training requirements prior to operating Enbridge commercial vehicles. This training must be conducted to increase knowledge, reduce violations, and reduce the likelihood of collisions.

All drivers will receive training in the following subjects, as applicable:

- 
- Company safety program;
  - Safe vehicle operation;
  - Company maintenance program;
  - Traffic Safety Act and relevant transportation safety laws including:
    - Hours of service;
    - Daily trip inspections;
    - Weights and dimensions;
    - Cargo securement; and
    - Other regulations, as applicable to company operations.
  - The Dangerous Goods Transportation and Handling Act and regulations made under that Act;

Training will be performed both in-house and by external providers.

**All drivers will have records of training in their file (e.g., training certificates or other records showing the time, date, and type of training).** A copy of applicable legislation will be made available for all staff (e.g., website access, hard copy, or disk).

#### **7.4 ORIENTATION**

All new drivers will receive training on Enbridge's safety and maintenance policies. Orientation must be completed before drivers drive to ensure they know the laws that apply on that first trip.

New drivers will also receive training in the following subjects upon hire:

- Hours of Service
- Daily trip inspections
- Cargo/load securement

#### **7.5 ONGOING TRAINING**

Drivers will receive ongoing training throughout their employment, please refer to your Business Specific Training Matrix for details regarding training.

#### **7.6 SAFE USE AND OPERATION OF VEHICLES**

Enbridge will ensure all drivers are aware of the safe use and operation of commercial vehicles.

Drivers must comply with all transportation safety laws and provincial laws.

#### **7.7 COMPLIANCE WITH THE LAW**

##### **Vehicle Condition**

Ensure Vehicle Maintenance requirements are met as outlined in Appendix B.

---

### **Cell Phones**

While operating a Commercial Motor Vehicle, drivers are prohibited from:

- Using hand-cell phones; and
- Texting or emailing.

### **Speed Limits**

Drivers must obey all posted speed limits and reduce speed according to road, weather, visibility conditions and vehicle type. All drivers shall immediately report all violations to Enbridge, including all violations incurred while driving off duty.

Drivers shall also:

- Be self-disciplined to control vehicle speed by being aware of the posted speed limit and continually scanning their instrument panel to check their actual speed;
- Reduce speed when driving in inclement weather, when approaching crest of curves or hills, and for head light illumination during night driving;
- Reduce speed on ramps and stay well below posted ramp speeds;
- Reduce speed in school zones and playground areas; and
- Control vehicle speed to maintain visibility and to recognize hazards well in advance.

### **Seat Belt Use**

Enbridge requires all authorized drivers, while operating or travelling as a passenger in ALL company vehicles (commercial or non-commercial), to wear seat belt(s) always while vehicle is in motion.

## **7.8 ADDITIONAL REQUIREMENTS**

### **Drug and Alcohol Policy**

Requirements pertaining to controlled substances and alcohol are outlined in the [Enbridge Workplace Alcohol & Drug Policy](#):

Drivers must be aware of the following:

- Illicit drugs mean any drug or substance which is not legally obtained and whose use, sale, possession, purchase, or transfer is restricted or prohibited by law (street drugs such as cocaine).
- Medication refers to a drug obtained legally, either over the counter or through a doctor's prescription.
- Beverage alcohol refers to beer, wine, and distilled spirits.

---

### **Cargo/Load Securement**

Enbridge and the driver will ensure that all cargo transported is contained, immobilized, or secured. According to National Safety Code Standard 10.

The following are some general guidelines for ensuring cargo is secured in a safe manner. Generally, cargo transported on a commercial vehicle must not:

- Leak, spill, blow off, fall from, fall through, or otherwise dislodge from the commercial vehicle; or
- Shift upon or within the commercial vehicle to such an extent that the commercial vehicle's stability or maneuverability is adversely affected.
- Drivers should inspect the cargo and its securing devices within the first 80 kilometers after beginning a trip. Drivers must re-inspect cargo when any one of the following occurs:
  - Change of duty status (e.g., from "driving" to "on duty not driving");
  - After driving for 3 hours; or
  - After driving 240 kilometers.

An employee or driver will not use any vehicle to transport goods unless:

- The vehicle is constructed to carry the goods; and
- There is equipment on the vehicle or attached to the vehicle that is capable of securing the goods to ensure the vehicle can be operated safely when loaded without danger of turning over the vehicle or the load shifting, swaying, blowing off, falling off, leaking or otherwise escaping.

Drivers are not permitted to transport any cargo unless they have been trained and certified. The load must also be properly secured. For more detailed information, refer to the company cargo securement training program.

### **Fatigued Driving and Stress**

Enbridge drivers are prohibited from driving if fatigued. Please adhere to Fatigue Management standard.

### **Operating an Unsafe Vehicle**

Drivers must not operate or permit another person to operate a commercial vehicle on a highway if the commercial vehicle or any equipment pertaining to the commercial vehicle is in a condition that is likely to cause danger to persons or property.

## **7.9 DOCUMENTATION – DRIVER QUALIFICATION FORMS (DQF)**

Application for Employment Supplement – Driver Qualification Data

Request for Motor Vehicle Driver's Record (MVR)



---

Request for Information from Previous Employer  
(Part I): Annual Driver's Certification of Violations  
(Part II): Annual Review of Driving Record  
Current Medical Exam Certificate (if applicable)  
Post-Trip Inspection Report  
Annual Vehicle Inspection Report  
Record of Road Test

## **8.0 TRAINING**

Personnel working in the field must be knowledgeable in this Standard and may be assigned applicable training as driven by the Safety Training Matrix.

Reference the Health & Safety training syllabi and matrices for further information and training re-certification requirements.

## **9.0 STANDARD REVIEW**

A subject matter expert (SME) will perform a technical review of this standard every two years to determine the accuracy of the content/information. The SME shall solicit input from applicable stakeholders to ensure the effectiveness of the standard. Any suggested changes must be reviewed and approved by the designated document owner.

## **10.0 RELATED DOCUMENTS**

Enterprise Travel Management Policy  
Material Handling Standard  
Workplace Drug & Alcohol Policy  
Safety While Driving Policy  
Vehicle Standard  
Motor Vehicle Records Procedure and Driving Improvement Plan

## **11.0 REFERENCES**

- Motor Vehicle Transport Act
- Motor Vehicle Safety Act
- National Safety Code
- Commercial Vehicle Drivers Hours of Service Regulations
- Alberta: Commercial Vehicle Certificate and Insurance Regulation;
- Alberta: Motor Vehicle Act and associated regulations;

- 
- Alberta: Commercial Vehicle Dimension and Weight Regulation
  - Manitoba: Highway Traffic Act, and associated regulations;
  - Ontario: National Safety Code Standard 15 (Ontario does not have legislation/regulation in place that directly addresses driver qualification files.)
  - Saskatchewan: The Commercial Vehicle and Drivers (Record-Keeping) Regulations;

Safety Programs Driver Files and Record Keeping (This is a guide and not meant to be a substitute for the actual legislation.)

---

## **APPENDIX A – HOURS OF SERVICE**

Hours of service legislation is safety legislation that ensures commercial drivers have enough opportunities to rest so that they do not drive when fatigued. Enbridge will comply with the Commercial Vehicle Drivers Hours of Service Regulations.

The regulations apply to trucks, tractors, or trailers, or any combination that have a gross vehicle weight exceeding 4,500 kilograms. Exemptions to this regulation require documented approval by the Provincial authority. The regulations do not apply when a driver is driving the vehicle for personal use, if:

- The vehicle has been unloaded;
- Any trailers have been unhitched;
- The distance traveled does not exceed 75 kilometers/46.6 miles in a day;
- The driver has recorded in his/her logbook the odometer reading at the beginning and end of the personal use; and
- The driver is not subject to an out-of-service declaration.

The following is a summary of the main regulatory requirements.

### **Driver Cycles**

Enbridge will adhere to the intent of the regulation to limit the driving and on-duty time in say, and to ensure drivers obtain enough rest, the regulations establish cycles that drivers must follow:

- Cycle 1
  - Allows drivers to accumulate 70 hours of on-duty time over seven days.
- Cycle 2
  - Allows drivers to accumulate 120 hours of on-duty time over 14 days.
- All drivers, regardless of cycle, must have taken a least 24 consecutive hours off-duty time in preceding 14 days.
- Cycle Reset
  - A driver may end the current cycle and begin a new cycle if they first take the following off-duty time:
    - Cycle 1 has at least 36 consecutive hours off-duty.
    - Cycle 2 has at least 72 consecutive hours off-duty.
  - After taking the off-duty time, the driver begins a new cycle, the accumulated hours are set back to zero and the driver's hours begin to accumulate again.
- Cycle Switching

- No driver shall switch from one cycle to the other without first taking the following off-duty time before beginning to drive again;
- Switch Cycle 1 to Cycle 2 – must have at least 36 consecutive hours off-duty
- Switch Cycle 2 to Cycle 1 – must have at least 72 consecutive hours off-duty
- After taking the off-duty time, the driver begins a new cycle, the accumulated hours are set back to zero and the driver's hours begin to accumulate again.

### **Responsibilities**

Enbridge and any shipper, consignee, or other person shall not request, require, or allow a driver to drive and no driver shall drive if:

- The driver's faculties are impaired to the point where it is unsafe for the driver to drive;
- Driving would jeopardize or be likely to jeopardize the safety or health of the public, the driver, or the employees of Enbridge;
- The driver is the subject of an out-of-service declaration; or
- The driver, in doing so, would not be in compliance with the Commercial Vehicle Drivers Hours of Service Regulations.

### **On Duty**

On duty time means the period that begins when a driver begins work or is required by Enbridge to be available to work, except where the driver is waiting to be assigned to work, and ends when the driver stops work or is relieved of responsibility by Enbridge, and includes driving time and time spent by the driver:

- Inspecting, servicing, repairing, conditioning, or starting a commercial vehicle;
- Travelling in a commercial vehicle as a co-driver
- Participating in the loading or unloading of a commercial vehicle;
- Inspecting or checking the load of a commercial vehicle;
- Waiting for a commercial vehicle to be serviced, loaded, unloaded or dispatched;
- Waiting for a commercial vehicle or its load to be inspected;
- Waiting at an in-route point because of an accident or other unplanned occurrence or situation;
- Resting in or occupying a commercial vehicle for any other purpose; and
- Performing any work for any motor carrier.

### **Travelling as a Passenger – Off Duty Time**

If a driver who has, at the request of Enbridge, spent time travelling as a passenger in a commercial vehicle to the destination at which the driver will begin driving takes 8 consecutive hours of off duty time before beginning to drive, the time spent as a passenger shall be counted as off duty time.

## Driving South of Latitude 60°N

### Daily Driving and On Duty Time

Enbridge will not request, require, or allow a driver to drive and no driver shall drive after:

- The driver has accumulated 13 hours of driving time in a day; or
- The driver has accumulated 14 hours of on duty time in a day.

### Mandatory Off Duty Time

Enbridge and its subsidiaries will not request, require, or allow a driver to drive and no driver shall drive after:

- The driver has accumulated 13 hours of driving time unless the driver takes at least 8 consecutive hours of off duty time before driving again;
- The driver has accumulated 14 hours of on duty time unless the driver takes at least 8 consecutive hours of off duty time before driving again; or
- Sixteen (16) hours of time have elapsed between the conclusion of the most recent period of 8 or more consecutive hours of off duty time and the beginning of the next period of 8 or more consecutive hours of off duty time.

### Daily Off Duty Time

Enbridge and its subsidiaries will ensure that a driver shall take at least 10 hours of off duty time in a day. Off duty time other than the mandatory 8 consecutive hours may be distributed throughout the day in blocks of no less than 30 minutes each. The total amount of off duty time taken by a driver in a day shall include at least 2 hours of off duty time that does not form part of a period of 8 consecutive hours of off duty time.

### Deferral of Daily Off Duty Time

A driver who is not splitting off duty time in accordance with the Commercial Vehicle Drivers Hours of Service Regulations may defer a maximum of 2 hours of the daily off duty time to the following day if:

- The off-duty time deferred is not part of the mandatory 8 consecutive hours of off duty time;
- The total off duty time taken in the 2 days is at least 20 hours;

- The off-duty time deferred is added to the 8 consecutive hours of off duty time taken in the second day;
- The total driving time in the 2 days does not exceed 26 hours; and
- There is a declaration in the “Remarks” section of the daily log that states that the driver is deferring off duty time under this section and that clearly indicates whether the driver is driving under day one or day two of that time.

### **Ferries**

A driver travelling by a ferry crossing that takes more than 5 hours is not required to take the mandatory 8 consecutive hours of off duty time if:

- The time spent resting in a sleeper berth while waiting at the terminal to board the ferry, in rest accommodations on the ferry and at a rest stop that is no more than 25 km from the point of disembarkation from the ferry combine to total a minimum of 8 hours;
- The hours are recorded in the daily log as off duty time spent in a sleeper berth;
- The driver retains, as a supporting document, the receipt for the crossing and rest accommodation fees; and
- The supporting document coincides with the daily log entries.

### **Splitting of Daily Off Duty Time**

While the rules provide split sleeper allowances, Enbridge does not operate vehicles equipped with sleeper berths.

### **Driving North of 60°N**

There are different rules for drivers operating north of 60° latitude (Northwest Territories and Yukon Territory).

### **Emergencies and Adverse Driving Conditions**

The requirements of the federal hours of service regulations in respect of driving time, on duty time, and off duty time do not apply to a driver who, in an emergency, requires more driving time to reach a destination that provides safety for the occupants of the commercial vehicle and for other users of the road or the security of the commercial vehicle and its load.

Enbridge and its subsidiaries' drivers who encounter adverse driving conditions while operating the vehicle may extend the permitted 13 hours of driving time and reduce the 2 hours of daily off duty time required by the amount of time needed to complete the trip if:

- The driving, on duty and elapsed time in the elected cycle is not extended more than 2 hours;
- The driver still takes the required 8 consecutive hours of off duty time; and
- The trip could have been completed under normal driving conditions without the reduction.

Drivers extending their driving, on duty or elapsed time because of an emergency or adverse driving conditions are required to record the reason for doing so in the "Remarks" section of the daily log.

### **U.S. Drivers Operating Into Canada**

A U.S. driver is required to comply with the Canada's hours of service regulations. Complying with Canada's hours of service regulations involves including the additional items Canada requires on the log, such as, the driver's name printed, the driver's cycle declaration, starting and ending odometer reading, carrier's principal place of business address and personal use starting and end odometer reading (if applicable).

If a U.S. driver entering Canada doesn't have a log for the day immediately preceding the day on which he/she will be entering Canada, he/she must provide in the "Remarks" section a record of all off-duty and on-duty hours for the previous 14 days.

A U.S. driver entering Canada can handwrite Canada's additional items on the U.S. specific daily log as long as all of the required information is provided on the daily log, it will be acceptable in Canada.

### **Proper Hours of Service Record Completion**

Enbridge will train staff in hours of service records, weigh slips, and other documents that are required to be completed by NSC. A record will be maintained on each driver's file showing that the employee has the knowledge or received any training. The company will evaluate each type of record for proper completion.

#### **Daily Log Completion**

Unless exempt, all authorized drivers must complete daily logs for every calendar day they are employed by Enbridge. The information below provides a summary for what must be included in a daily log.

At the beginning of each day:

- The start time of day if different than midnight, driver's name, and if the driver is a member of a team of drivers, the names of the co-drivers;
- In the case of a driver who is not driving under the provisions of an oil well service permit, the cycle that the driver is following (70 hours/7 days or 120 hours/14 days);
- The commercial vehicle license plates or unit numbers;
- The starting odometer reading of each of the commercial vehicles operated by the driver;
- The names and the addresses of the home terminal and the principal place of business of every motor carrier by whom the driver was employed or otherwise engaged during that day;
- In the "Remarks" section of the daily log, if the motor carrier or driver was not required to keep a daily log immediately before the beginning of the day, the number of hours of off duty time and on duty time that were accumulated by the driver each day during the 14 days immediately before the beginning of the day; and
- If applicable, a declaration in "REMARKS" policy of the daily log that states that the driver is deferring off if applicable, the name of the location where each change of duty has occurred, whether the driver used any exemptions that allowed them to exceed the maximum driving limitations (emergency or adverse driving conditions), and personal conveyance starting/ending odometers (75 kilometers maximum per day), if applicable.

During the day:

- The hours in each duty status during the day covered by the daily log, and the location of the driver each time the duty status changes, as that information becomes known.
- At the end of each day:
- The total hours for each duty status and the total distance driven by the driver that day, excluding the distance driven in respect of the driver's personal use of the vehicle, as well as the odometer reading at the end of the day and sign the daily log attesting to the accuracy of the information recorded in it.

### **Electronic Logging Devices (ELD)**

Drivers will record time in ELD for each day, in accordance with federal and provincial regulations, and all the information associated with their record of duty status as their duty status changes. These requirements do not apply if:

- The driver drives a commercial vehicle within a radius of 160 km of the home terminal; and
- The driver returns to the home terminal each day to begin a minimum of 8 consecutive hours of off-duty time



In-vehicle information regarding ELDs that shall always be available (on electronic device or printed):

- ELD user manual;
- Instruction sheet describing how to transfer data (including step-by-step instructions for getting the driver's records to an enforcement official);
- Instruction sheet describing what to do when an ELD malfunctions;
- Blank paper logs to last at least 14 days. (If a driver continues to record their hours of service on a paper log beyond 14 days, there is a risk of risks being placed out of service.)

### **Malfunction of an ELD**

If a driver of a commercial vehicle becomes aware that the ELD is displaying a malfunction or data diagnostic code, the driver shall notify their administration as soon as the vehicle is parked.

### **Roadside Inspections**

When requested to do so by a director or an inspector, the driver will immediately provide the information for the previous 14 days by producing it on a digital display screen of the electronic recording device or in handwritten form or on a print-out or any other intelligible output, or any combination of these;

- the driving time and other on-duty time for each day on which the device is used
- the total on-duty time remaining and the total on-duty time accumulated in the cycle being followed by the driver, and
- the sequential changes in duty status and the time at which each change occurred for each day on which the device is used;

Driver is capable, if so requested by an inspector, of preparing a handwritten daily log from the information stored in the device for each day on which the device is used;

The device automatically records when it is disconnected and reconnected and keeps a record of the time and date of these occurrences;

The device records the time spent in each duty status of the driver;

Hard copies of the daily log that is generated from the information that is stored in the device is signed on each page by the driver attesting to its accuracy.

**Blank paper logs will be carried in vehicle for use in event of electronic log failure. The driver must be ready to manually prepare a logbook if the device does not work.**

Exemption to use Electronic Logging Devices

- Pre-2000 vehicles are exempt from the mandates

- Operate under a specific permit issued
- Have a statutory exemption
- Are subject to a rental agreement with terms under 30 days

### **Retention and Distribution of Logbooks/Time Records**

Electronic logs will be retained on fleet provider database for a minimum of 6 months.

Drivers must forward the original copy of their paper log (if applicable) and supporting documents to their home terminal within 20 days of the completion of the daily log.

Within 30 days of receiving the daily logs and supporting documents, Enbridge will deposit these records at the Enbridge principal place of business and retain all daily logs and supporting documents in chronological order for each driver for at least 6 months.

Hours of service records will be made available upon request.

### **Time Records for Drivers Operating within 160 kilometers of the Home Terminal**

Authorized drivers are not required to maintain a daily log where **ALL** the following conditions are met:

- Driver/vehicle does not operate beyond 160 kilometers radius of the home terminal;
- Driver returns to home terminal each day to begin a minimum of 8 consecutive hours of off-duty time;
- Driver maintains and retains for 6 months accurate and legible records showing each day their duty status and elected cycle, the hour at which each duty begins and ends and the total number of hours spent in each status; and
- The driver is **NOT** driving under a permit issued under the Commercial Drivers' Hour of Service Regulation.

## **Monitoring Hours of Service Compliance**

Enbridge has the responsibility to monitor the compliance of drivers' hours of service records and will monitor the compliance of each driver with the Commercial Vehicle Drivers Hours of Service Regulations.

---

During the monitoring process, People Leaders will address all fatigue-related violations found in these records. Hours of service violations considered to be “fatigue-related” include:

- False records (identified using independent supporting documents);
- More than one record for each day;
- Missing records (every day must be accounted for);
- Records not current to the last change of duty status;
- Driving over any hour limits specified in regulation;
- Drivers not meeting off duty requirements or taking time breaks as required by regulation;
- Using the 160-kilometer radius exemption when the driver does not meet all specified criteria; and
- Failing to meet any condition of a permit related to hours of service.

## **APPENDIX B – VEHICLE MAINTENANCE AND INSPECTIONS**

### **Roadside Inspections**

- Inspections are conducted by specially trained third-party inspectors to ensure a safer highway environment under guidelines developed by the Commercial Vehicle Safety Alliance (CVSA).
  - Drivers are required to conduct themselves professionally with enforcement officers during roadside inspections and offer documents upon request. Drivers will always be truthful when asked questions concerning their duty status, qualifications, route, vehicle, or other compliance concerns.
  - When a driver is approached to undergo a roadside inspection, he/she must go immediately to the area designated by the inspection officer. If the driver believes that the designated area is unsafe for the driver and/or the inspection officer, the driver shall state his/her concern to the inspection officer in a courteous and professional manner. Once the inspection is underway, the driver shall follow the directions given by the officer and act appropriately.
  - If a driver receives an inspection report, they shall submit a copy of the roadside inspection report and any other supporting documentation to their People Leader before the end of the next business day.

### **Maintenance and Inspection Program Overview**

#### **Part 1: Scheduled Vehicle Maintenance**

Enbridge will routinely inspect applicable vehicle components as listed in:

- Schedule 1 NSC Standard 13 (daily trip inspection).

Any component identified as needing repair and/or maintenance will be serviced as required. The records documenting the maintenance will be retained in the appropriate vehicle file.

The company's written maintenance and inspection program will be kept at the company's principal place of business. A copy of the maintenance and inspection program shall be readily accessible to employees of Enbridge Pipelines Inc. who carry out the maintenance and inspection program. Enbridge Pipelines vehicle maintenance and inspection program will be implemented as follows:

- Daily Vehicle Inspection - Every 24 hours complete a daily vehicle inspection, report, all defects & document repairs.
- Lubrication - as per manufacturer's specifications
- Oil/Filter- as per manufacturer's specifications
- CVIP- annually required every 12 months before next CVIP\* expires.

Any equipment or safety systems installed in a vehicle by the manufacturer of the vehicle must be maintained in good working order and in accordance with the manufacturer's specifications. It is not only the responsibility of Enbridge Pipelines safety and management team to ensure that units are maintained as per the above schedule. It is the responsibility of the driver of our commercial vehicles to ensure that services do not go past the required interval. If you see that the vehicle is due for service a note may be made on the daily vehicle inspection report as well as a verbal heads up to your supervisor, as applicable.

\* *CVIP stands for Commercial Vehicle Inspection Program.*

## **Part 2: Daily Trip Inspections**

Enbridge is required by the Motor Carrier Compliance for Canada regulation to ensure our commercial motor vehicles are inspected daily.

- Enbridge shall not permit a driver to drive, and a driver shall not drive, a commercial vehicle unless:
  - The commercial vehicle has been inspected in accordance with the daily trip inspection requirements set out in this standard; and
  - No major defect was detected in the vehicle during the daily trip inspection referred to in clause (i).
- A daily trip inspection is valid for 24 hours from the time recorded in the trip inspection report. Enbridge requires drivers (or a person authorized by Enbridge) to conduct a daily trip inspection:
  - With respect to a truck, truck-tractor, or trailer, using Schedule 1 of National Safety Code (NSC) Standard 13;

Drivers will ensure that a copy of Schedule 1 inspection is in each commercial vehicle and shall have available when requested by a peace officer.

### **Completion of the Daily Trip Inspection Report**

Drivers shall document daily trip inspections. The Daily Trip Inspection is required to be completed **(whether a deficiency is identified or not)**.

Electronic systems are required to be used to capture daily inspections.

A daily trip inspection report includes the following information:

- The vehicle's license plate, identification number or unit number;
- The odometer or hub odometer at the time of inspection;
- The name of the carrier operating the commercial vehicle (Enbridge);
- The name of the municipality or location on the highway where the inspection was conducted;
- The time and date that the report was made;

- Any defect related to the operation of any item required to be inspected or that no defect was detected;
- The name of the person who inspected the vehicle and a statement signed by that person stating that the vehicle has been inspected in accordance with of the Commercial Vehicle Safety Regulation (AR 121/2009); and
- The name and signature of the person making the report.

### **Defects Observed During Operation of the Vehicle**

If a driver observes any safety defects as specified in Schedule 1 of NSC Standard 13 while driving the vehicle, the driver must record the defects in the trip inspection report or in a written document and report those defects to People Leader.

If a major defect is detected, drivers are prohibited from operating the vehicle and must notify People Leader immediately.

Drivers will produce the trip inspection report when requested by a peace officer.

### **Distribution and Retention of Trip Inspection Reports**

- Electronic reports will be retained on fleet provider database for a minimum of 6 months.
- Paper copies will be forwarded to the home terminal within 20 days of completion of the report;
- Enbridge is responsible for ensuring that paper trip inspection reports are submitted as required and will maintain inspection reports at the principal place of business within 30 days of receiving the report; and
- The original report will be retained in chronological order for the month it was created and a minimum of an additional 6 months.

### **Requirement to Repair, Correct, and Report Defects**

- Drivers are prohibited from driving a commercial vehicle with any uncorrected or unrepaired major defect(s) (see Schedules 1 or 2 of NSC Standard 13 for a description of a major defect);
- Anyone conducting a daily trip inspection is required to document any defects on the electronic trip inspection report;
- People Leader or driver will certify on the report that the defect has been repaired/corrected or certify on the report the repair/correction is unnecessary;
- If a driver or person authorized by Enbridge believes or suspects there is a safety defect in the commercial vehicle, they shall report the safety defect to People Leader without delay if the defect is a major defect, or in a timely manner but not later than the next required daily trip inspection in all other cases.

This standard does not apply to a commercial vehicle that is engaged in the transportation of goods or passengers for the purpose of providing immediate relief in the case of a natural disaster or disaster caused by human intervention.

## **APPENDIX C – VEHICLE RECORDKEEPING**

### **Part 3: Recordkeeping**

#### **Vehicle Files**

Enbridge will maintain vehicle files to ensure that all vehicles are adequately maintained in a satisfactory mechanical condition. Each commercial vehicle registered to Enbridge will have a vehicle file that includes the following information:

- Identification of the vehicle, including:
  - A unit number, the manufacturer's serial number or a similar identifying mark.
  - The make of the vehicle; and
  - The year of manufacture.
- A record of the inspection of the vehicle under the Motor Carrier Compliance for Canada, and repairs, lubrication, and maintenance for the vehicle, including:
  - The nature of the inspection or work performed on the vehicle; and
  - The date on which that inspection or work took place and the odometer or hub-o-meter reading on the vehicle at that time.
- Notices of defect received from the vehicle manufacturer and the corrective work done on the vehicle in relation to those notices.
- Trip inspection reports.

Enbridge will ensure that the records required to be maintained under this standard are true, accurate and legible.

#### **Record Retention**

Vehicle records identified above will be retained for the year they are created and at minimum an additional 4 years. All records will be kept for at minimum 6 months after the vehicle is retired or disposed of. These records may be maintained in electronic or hardcopy format if they can be readily produced to a peace officer upon request.

The person conducting the trip inspection will certify that any major defect has been repaired/corrected or certifies on the report that repair/correction is unnecessary; a driver shall not drive or be permitted to drive until all major defects have been repaired.

## **APPENDIX D – USE OF SAFETY EQUIPMENT**

### **Safety Equipment**

A vehicle registered as having a maximum gross in excess of 4,500 kilograms, cannot be operated on a highway unless the driver carries in the vehicle (for the purpose of warning the travelling public of an emergency breakdown);

- Two safety red triangles, or other warning devices consisting of at least two reflectors.
- Fire extinguisher
  - Design and type approved and labelled by F.M., U.L., or U.L.C. and rated at least 2A-10BC.
- Tire chains (as required)

### **Use of Warning Devices**

Warning triangles and hazard lights are used to make other traffic aware of a potential hazard or parked commercial vehicles.

During the nighttime a commercial vehicle will not be stationary on a highway outside the limits of an urban area unless:

- The hazard lights are operating if functional; and
- Advanced warning triangles are placed without delay on the highway in line with the commercial vehicle at approximately 30 meters behind and in front of the commercial vehicle.

When there is insufficient light or conditions where objects are not clearly discernable at 150 meters, commercial vehicles will not be stationary outside of the limits of an urban area unless:

- The hazard lights are operating if functional; and
- Advanced warning triangles are placed without delay on the highway in line with the commercial vehicle at approximately 75 meters behind and in front of the commercial vehicle.

During the daytime a person will not permit a commercial vehicle to be stationary on a highway outside the limits of an urban area unless:

- The hazard lights are operating if functional; and
- Advanced warning triangles are placed without delay on the highway in line with the commercial vehicle at approximately 75 meters behind and in front of the commercial vehicle.

### **Use of Fire Extinguishers**

- Reference Emergency Preparedness Personal Safety LP Standard



## Change Log

Section	Version 3.0	Version 3.1
Entire document		Clerical corrections including spelling, grammar, and document names.
4.0		Updated terminology from incident and investigation to event and analysis.
11.0 References		Added - Motor Vehicle Safety Act - National Safety Code - Commercial Vehicle Drivers Hours of Service Regulations - Alberta: Commercial Vehicle Dimension and Weight Regulation
Appendix A	Driving North of 60°N  While there are different rules for drivers operating north of 60° latitude (Northwest Territories and Yukon Territory), Enbridge drivers do not operate CVOR vehicles north of 60° latitude.	Driving North of 60°N  There are different rules for drivers operating north of 60° latitude (Northwest Territories and Yukon Territory).

<End of Document>



---

# Standard

---

## Commercial Motor Vehicle (DOT Drivers)- US

---

**Effective Date:** 2019-05-01

**Version #:** 2.1

**Version Date:** 2024-03-28

---



This page intentionally left blank



Document Version Register

Version Number	Version Date	Approved By	Section Number and Title	Details of Version
1.0	2019-03-30	Sean Evans	Replacement in Kind. Information pulled from LP/MP Safety Manual	Changed formatting as a part of the Safety Manual Transition Project.
2.0	2021-10-18	Jeff Safioles	Whole Document	Complete rewrite of this safety standard
2.1	2024-03-28	Troy Croft	6.8 All sections	Alignment with Management System Framework - Event Analysis. Clerical corrections



This page intentionally left blank



---

## Table of Contents

1.0 Purpose .....	6
2.0 Scope .....	6
3.0 Prerequisites.....	6
4.0 Definitions & Acronyms .....	6
5.0 Roles & Responsibilities.....	10
6.0 Standard-Specific Requirements .....	12
6.1 Qualifications of Company CMV Drivers .....	12
Disqualification of Drivers .....	13
6.2 Controlled Substance Testing (CDL Drivers) .....	14
6.3 Steps for Qualifying CMV Drivers.....	14
6.4 CMV Driver Qualification Documentation and Retention .....	17
6.5 Commercial Driver’s License (CDL) .....	17
6.6 Licensing Requirements and Testing .....	17
6.7 Parts and Accessories Necessary for Safe Operation of Vehicles .....	19
6.8 Notification, Reporting, and Recording of Accidents .....	19
6.9 Hours of Service and Driving Logs .....	20
6.10 Vehicle Inspections.....	20
6.11 Roadside/Weigh Station Inspections.....	21
6.12 Drug and Alcohol Policy .....	22
6.13 Documentation .....	22

---

7.0	Training.....	23
8.0	Related Documents.....	23
<b>9.0</b>	<b>STANDARD REVIEW</b> .....	<b>23</b>
10.0	References.....	23
11.0	Appendix.....	25
11.1	Marking of Commercial Motor Vehicles.....	25
11.1.1	Requirements- Markings of Commercial Motor Vehicles.....	25
11.1.2	Rented Commercial Motor Vehicles.....	26
11.2	Commercial Motor Vehicle Parameters.....	27
	Flowchart to Determine if a Commercial Motor Vehicle.....	27
	Table to Determine Commercial Motor Vehicle Status.....	28
11.3	Hours of Service Requirements.....	29
11.3.1	Introduction.....	29
11.3.2	Purpose and Scope.....	29
11.3.3	Responsibilities.....	29
11.3.4	Rules.....	32
11.3.5	Limits.....	32
11.3.5	Exceptions.....	34
11.3.6	Malfunctions.....	35
11.3.7	Supporting Documents.....	36

---

## 1.0 PURPOSE

The purpose of this standard is to ensure that Enbridge workforce and contractors use accepted means when operating Company owned, rented, or leased commercial motor vehicles.

## 2.0 SCOPE

This standard applies to employees who operate Company owned, rented, or leased commercial motor vehicles.

Contractors and subcontractors shall comply with Enbridge health and safety requirements set out in this standard. If a contractor or subcontractor has a health and safety standard or policy materially different from Enbridge's, the contractor/subcontractor shall follow the most stringent requirement. Contractors and subcontractors are still obligated to meet the requirements of all applicable laws related to this standard.

In the event a contractor's or subcontractor's standard exceeds the requirements of this standard, Enbridge may, in its sole discretion, choose to adopt the contractor's or subcontractor's standard for any given contract or work order.

## 3.0 PREREQUISITES

Directly Related to Hours of Service are key H&S program expectations. These expectations are found in the Environmental Conditions Standard and the Fatigue Management Standard. Expectations that should be understood and coordinated with hours of service.

- Complete Journey Management planning when required as outlined in the Environmental Conditions Standard. (When workers are travelling more than 2 continuous hours.)
- When applicable working alone practices should be implemented as outlined in the Environmental Conditions Standard
- Utilize or develop Fatigue Management plans when expecting hours of service could impact performance.

## 4.0 DEFINITIONS & ACRONYMS

*Adverse Driving Conditions* – Snow, sleet, fog, other adverse weather conditions, a highway covered with snow or ice, or unusual road and traffic conditions, none of which were apparent on the basis of information known to the person dispatching the run at the time it was begun.

*Client Information Center (CIC)* – 3rd party vendor's comprehensive web-based compliance resource used to maintain driver qualification files.



*Commercial Driver's License (CDL)* – A license issued by a State or other jurisdiction, in accordance with the standards contained in 49 CFR Part 383, to an individual which authorizes the individual to operate a class A, B or C commercial motor vehicle.

*Commercial Motor Vehicle (CMV) operator* – A person who operates a Company owned, rented or leased vehicle that meets the definition of a commercial motor vehicle.

*Commercial Motor Vehicle (CMV) -requiring CDL* – A motor vehicle or combination of motor vehicles used in commerce to transport passengers or property if one or more of the following applies to the motor vehicle:

- Has a gross combination weight rating of 11,794 kilograms or more (26,001 pounds or more) inclusive of a towed unit(s) with a gross vehicle weight rating of more than 4,536 kilograms (10,000 pounds).
- Has a gross vehicle weight rating of 11,794 or more kilograms (26,001 pounds or more).
- Is designed to transport 16 or more passengers, including the driver.
- Is of any size and is used in the transportation of hazardous materials as defined in this SOP (standard operating procedure)

*Commercial Motor Vehicle (CMV)* – A motor vehicle or combination of motor vehicles used in commerce to transport passengers or property if one or more of the following applies to the motor vehicle:

- A vehicle with a gross vehicle weight rating or gross combination weight rating, or gross vehicle weight or gross combination weight, of 4,536 kg (10,001 pounds) or more, whichever is greater; or
- Is designed or used to transport more than 8 passengers (including the driver) for compensation; or
- Is designed to transport 16 or more passengers, including the driver.
- Is of any size and is used in the transportation of hazardous materials as defined in this procedure.

*Compliance Safety Accountability (CSA)* – The Federal Motor Carrier's data-driven safety compliance and enforcement program designed to improve safety and prevent commercial motor vehicle (CMV) crashes, injuries, and fatalities. CSA consists of three core components; the Safety Measurement System (SMS); interventions; and a Safety Fitness Determination (SFD) rating system to determine the safety fitness of motor carriers.

*DOT* – Department of Transportation

*DOT Markings* – The US DOT number and company name is used by enforcement to determine who is legally responsible for the operation and safety of the commercial motor vehicle. Appendix B, DOT Markings

*DOT Reportable Accident* – An occurrence involving a CMV operating on a highway in interstate or intrastate commerce which results in:

- A fatality;
- Bodily injury to a person who, as a result of the injury, immediately receives medical treatment away from the scene of the accident; or
- One or more motor vehicles incurring disabling damage as a result of the accident, requiring the motor vehicle(s) to be transported away from the scene by a tow truck or other motor vehicle.

*Emergency* – Any hurricane, tornado, storm (e.g., thunderstorm, snowstorm, ice storm, blizzard, sandstorm, etc.), high water, wind-driven water, tidal wave, tsunami, earthquake, volcanic eruption, mud slide, drought, forest fire, explosion, blackout or other occurrence, natural or man-made, which interrupts the delivery of essential services (such as, electricity, medical care, sewer, water, telecommunications, and telecommunication transmissions) or essential supplies (such as, food and fuel) or otherwise immediately threatens human life or public welfare, provided such hurricane, tornado, or other event results in a declaration of an emergency by the President of the United States, the governor of a state, or their authorized representatives having authority to declare emergencies; by the FMCSA Field Administrator for the geographical area in which the occurrence happens; or by other federal, state or local government officials having authority to declare emergencies.

*Emergency condition* – Condition requiring immediate response, that if left unattended, is reasonable likely to result in immediate serious bodily injury, harm, death, or substantial damage to property. For a pipeline emergency, such conditions include (but are not limited to) indication of an abnormal pressure event, leak, release, or rupture.

*Fatality* – Any injury which results in the death of a person at the time of the motor vehicle accident or within 30 days of the accident.

*FMCSA* – Federal Motor Carrier Safety Administration

*GCWR* – Gross Combination Weight Rating

*GVWR* – Gross Vehicle Weight Rating

*Highway* – Any road, street, or way, whether on public or private property, open to public travel. “Open to public travel” means that the road section is available, except during scheduled periods, extreme weather or emergency conditions, passable by four-wheel standard passenger cars, and open to the general public for use without restrictive gates, prohibitive signs, or regulation other than restrictions based on size, weight, or class of registration.

---

*Interstate Commerce* – trade, traffic, or transportation in the United States:

- Between a place in a state and a place outside of such state (including a place outside of the United States);
- Between two places in a state through another state or a place outside of the United States; or
- Between two places in a state as part of trade, traffic, or transportation originating or terminating outside the State or the United States.

*Intrastate Commerce* – Any trade, traffic, or transportation in any state which is not described in the term interstate commerce.

*Materials of Trade* – The materials of trade are those materials carried on commercial motor vehicles for the following reasons:

- For protecting the safety and health of the driver and passengers of the motor vehicle. Materials include fire extinguisher, insect repellent, self-contained breathing apparatus, emergency oxygen supply, etc.
- For supporting the operation of the motor vehicle. Materials include carburetor cleaner, starting fluid, spare battery, etc.
- For the direct support of the principal business that is other than transportation. Materials include WD-40, paint, pipe coating, propane cylinders, gasoline, etc.

*Out of service (OOS) Violation* – Violation that removes the driver and CMV off the roadway until the violation is corrected.

*Private Motor Carrier* – A person who provides transportation of property or passengers, by commercial motor vehicle, and is not a for-hire motor carrier.

*Texting* – Manually entering alphanumeric text into, or reading text from, an electronic device. This action includes, but is not limited to, short message service, emailing, instant messaging, a command or request to access a World Wide Web page, pressing more than a single button to initiate or terminate a voice communication using a mobile telephone, or engaging in any other form of electronic text retrieval or entry, for present or future communication. Texting does not include:

- Inputting, selecting, or reading information on a global positioning system or navigation system; or
- Pressing a single button to initiate or terminate a voice communication using a mobile telephone; or
- Using a device capable of performing multiple functions (e.g., fleet People Leader systems, dispatching devices, smart phones, citizens band radios, music players, etc.)
- Using a Handheld Mobile Telephone

- Using at least one hand to hold a mobile telephone to conduct a voice communication,
- Dialing or answering a mobile telephone by pressing more than a single button, or
- Reaching for a mobile telephone in a manner that requires a driver to maneuver so that he or she is no longer in a seated driving position, restrained by a seat belt that is installed and adjusted per the manufacturer's instructions.

*Weigh Station* – is a checkpoint along a highway to inspect vehicular weights. States may also check the following: (Roadside Inspection)

- Driver and equipment for safe operations (license, hours of service, medical certificate, etc.)
- Freight paperwork (Shipping papers)
- Other state required documents (IFTA, etc.)

## **5.0 ROLES & RESPONSIBILITIES**

People Leaders shall:

- Ensure all employees driving commercial motor vehicles comply with this procedure.
- Not knowingly allow, require, permit, or authorize any employee whose license has been revoked, suspended, canceled, or disqualified to drive a motor vehicle until such license has been reinstated.
- Not allow unqualified drivers to drive a commercial motor vehicle.
- Reimburse cost associated with obtaining a CDL to carry out employee's job responsibilities minus the cost of a regular operator's license for that state in which the employee resides.
- Ensure all initial and expiring CMV driver qualification documentation is submitted to the company-approved third-party vendor who maintains driver qualification files to keep drivers in compliance.
- Consult with HR (Human Resources) and Vehicle Fleet Safety to determine if driving conviction placed driver in a high-risk category that could necessitate the need to complete a Driver Improvement Plan or other disciplinary action(s)
- Hours of Service (HOS) responsibilities are outlined in the appendix.
- Ensure vehicle is maintained to meet regulatory requirements.
- Ensure drivers comply with vehicle maintenance requirements.
- Certify all repairs or corrections and return all roadside inspections reports within 15 days of the inspection. (Forward copy to Fleet Safety)

- Ensure drivers receive remedial training as needed to address vehicle maintenance violations.
- Review the driver qualification/documentation.

Drivers (Employees):

- Shall not drive a commercial motor vehicle unless they are qualified to drive that vehicle.
- Shall follow all laws, rules, and company policies.
- Must notify (in writing) their People Leader within 30 days of any conviction of violating state or local traffic laws relating to motor vehicle traffic control other than parking violations.
- Who have driver's license suspended, revoked, or canceled by a state, shall lose the right to operate a motor vehicle and must notify his/her People Leader of such suspension, revocation, cancellation, lost privilege, or disqualification. This notification must be made before the end of the business day following the day in which notice of suspension, revocation, cancellation, lost privilege or disqualification has been made.
- Are prohibited from the following:
  - Having more than one license.
  - Utilizing a radar detector while operating a commercial motor vehicle.
  - Allowing unauthorized passengers (non-company) employees to ride in vehicle without approval from their People Leader.
  - Utilizing a mobile telephone or while texting while operating a commercial motor vehicle.
- Will utilize their collision avoidance skills by managing their speed and space management.
- Hours of Service (HOS) responsibilities are outlined in the HOS Appendix.
- Shall ensure vehicle maintenance is adhered to including the following:
  - Drivers will not operate an unsafe vehicle until it has been repaired and documented.
  - Drivers will consult with People Leader to address matters related to the maintenance of vehicles.
  - Drivers will report results of all roadside inspections to their People Leader within 24 hours.

Safety Team shall:

- Maintain a DOT accident register (log), a listing of all CMV qualified drivers and all CMV driver qualification forms.
- Maintain all CMV driver qualification documentation in a secured area, limiting access.
- Provide People Leaders with updates of CMV operators driver qualification status.
- Monitor the data in the CSA for trend analysis.

- Assist in providing ongoing driver training/instruction and subject matter based on events, risk, trends, and seasonal road conditions. This information will be shared when appropriate.

Safety Shared Services shall:

- Be responsible for the maintenance and continuous improvement of this Standard.

## **6.0 STANDARD-SPECIFIC REQUIREMENTS**

### **6.1 QUALIFICATIONS OF COMPANY CMV DRIVERS**

Company CMV drivers must, at a minimum, meet the following qualifications:

- 21 years old to operate a commercial motor vehicle in interstate operations.
- Read and speak the English language well enough to converse with the public; to understand highway traffic signs in the English language; to respond to official inquiries; and to make entries on reports and records.
- Safely operate the type of vehicle assigned to driver by reason of experience, training, or both.
- Familiar with the methods and procedures for securing cargo in or on the vehicle to be driven.
- Physically able to pass a medical exam provided by an examiner listed on a National Registry. Refer to “National Registry of Certified Medical Examiners Search”.
- Those operating a motor vehicle with a GVWR or GCWR of 26,001 lbs. or greater, pulling a trailer of 10,001 lbs. or greater, or operates a vehicle that hauls hazardous materials in quantities requiring the vehicle to be placard must successfully obtain a Commercial Driver’s License (CDL) from the state in which that driver resides. Refer to Commercial Driver’s License section of this procedure.
- Has provided the Company with a list of violations of motor vehicle traffic laws and ordinances (other than parking violations) of which the driver has been convicted, or violations on which he has forfeited bond or collateral during the past 12 months. This includes violations incurred in a personal motor vehicle.
- Not disqualified to drive a motor vehicle for reasons defined in the “Disqualification of Driver” section of this procedure.
- Successfully completed a Driver’s Road Test, and has a certificate certifying that he or she passed the test. A road test must be completed for each type of vehicle that a driver may operate.

Drivers not meeting the CMV qualifications listed above shall not drive a commercial motor vehicle.

---

## **DISQUALIFICATION OF DRIVERS**

Any drivers disqualified from driving a CMV shall adhere to the following:

- Driver is disqualified for the duration of his or her loss of privilege to operate a commercial motor vehicle on public highways, either temporarily or permanently, by reason of the revocation, suspension, withdrawal or denial of an operator's license, permit or privilege until that operator's license, permit or privilege is restored by the authority that revoked, suspended, withdrew or denied it.
- Drivers must notify his/her People Leader of any revocation or suspension of license by the end of the day following the receipt of the notice.
- Drivers will be disqualified for the following criminal misconduct:
  - Conviction of or forfeiture of bond or collateral upon a charge of disqualifying offense and disqualified time listed below.
    - Disqualifying offenses:
      - Operating a motor vehicle while under the influence of alcohol, amphetamines, narcotic drugs, formulation of amphetamines, or a derivative of narcotic drugs.
      - Crime involving the transportation, possession, or unlawful use of amphetamines, narcotic drugs, formulations of an amphetamine, or derivatives of narcotic drugs.
      - Leaving the scene of an accident which resulted in personal injury or death.
      - Felony involving the use of motor vehicle.
  - Duration of disqualification for criminal misconduct:
    - For one year after the date of conviction or forfeiture of bond or collateral if, during the three years preceding that date, employee was not convicted of or did not forfeit bond or collateral upon a charge of an offense that would disqualify employee under the requirements of this procedure.
    - For three years, after the date of conviction or forfeiture of bond or collateral if, during the three years preceding that date, employee was convicted of, or forfeited bond or collateral upon a charge on an offense that would disqualify employee under the requirements of this procedure.

Refer to 49 CFR, Part 383- Commercial Driver's License Standards; Requirements and Penalties for CDL Driver Disqualification requirements.

### CDL Driver Disqualifications

- 24-hour Out-Of-Service Rule – A driver is considered to be driving under the influence of alcohol if the driver's blood alcohol concentration is .04 percent or more. If the driver is suspected of driving under the influence of alcohol and it is less than .04 percent, but there is a detectable amount, the driver will be considered out-of-service for 24 consecutive hours.

- 60-Day Disqualification – Two serious traffic violations in a three-year period.
- 120-Day Disqualification – Three serious traffic violations in a three-year period.
- 1 Year Disqualification:
  - Driving a commercial vehicle under the influence of alcohol if the driver's blood alcohol concentration is .04 percent or more.
  - Leaving the scene of an accident involving a commercial motor vehicle.
  - Using a commercial motor vehicle in the commission of any felony.
- Lifetime Disqualification:
  - Two or more convictions of the violations listed above.
  - Using a commercial motor vehicle in the commission of any felony involving the manufacture, distribution, or dispensing of a controlled substance, or possession with intent to manufacture, distribute or dispense a controlled substance.

Refer to 49 CFR, Part 383- Commercial Drivers License Standards; Requirements and Penalties for CDL Driver Disqualification requirements.

## **6.2 CONTROLLED SUBSTANCE TESTING (CDL DRIVERS)**

Follow Enbridge Drug & Alcohol policy.

## **6.3 STEPS FOR QUALIFYING CMV DRIVERS**

Qualifications and disqualifications for drivers must meet the current Department of Transportation (DOT) Federal Motor Carrier Safety Administration (FMCSA) regulations.

All requests to qualify drivers are to be directed to Safety including the following:

- Copy of current driver's license
- Completion of the following seven (7) forms in the order listed:
  1. Application for Employment Supplement - Driver Qualification Data; Identified as "Driver Application" in the Resource Center on the CIC.
    - This form should be completed by the driver/applicant.
  2. Request for Information from Previous Employer; Identified as "Safety Performance History Records Request" in the Resource Center on the CIC.
    - Supervisor must direct a letter to each employer by whom the driver was employed during the preceding three-year period.
    - Inquiry must be made within 30 days from the date of the application as a CMV driver. This requirement may be satisfied by the responses received at the time pre-employment inquiries are directed to previous employers.
    - If the employee has been employed by the Company for three years or more then the local supervisor shall complete the employee verification



form; identified as DOT/FMCSA Employment Verification in the Resource Center on the CIC.

3. Request for Motor Vehicle Driver's Record (MVR).

- This completed form should be forwarded by the supervisor to Safety for submission.
- Safety will obtain the motor vehicle record from Human Resources or Company approved 3<sup>rd</sup> part vendor and submit to be loaded into CIC. Once loaded to the CIC, Supervisors may access the MVR.
- This inquiry must be made within 30 days from the date of application.

4. Examination to Determine Physical Condition of Drivers; Identified as Medical Exam

- All drivers qualified under the regulations are required to have a physical examination every twenty-four months or in the event a driver whose ability to perform his/her normal duties has been impaired by a physical or mental injury or disease.
- The physical examination will be conducted by a company approved physician at company's expense, after they have satisfied the requirement of investigation and inquiries, as well as successful completion of the Driver's Road Test.
- The physician, after completing the physical examination must sign the examination form, the medical examiner's certificate and the Driver's Physical Examination Pocket Card.
- Enbridge will verify the Medical Examiner who issues the Medical Examiner's Certificate is on the National Registry by completing Medical Examiner's National Registry Verification.
- All CDL holders shall submit a copy of their medical exam certificate to their State Driver's Licensing Agency within 72 hours of receiving.
- Enbridge (or designee) will pull a medical MVR within 15 days from the date of issuance.

\*Note Driver must have a current Medical Exam certificate prior to completing the Record of Road test or any operation of a CMV. Only physically qualified individuals are permitted to drive a Company CMV.

5. Medical Examiner's National Registry Verification (MENRV)

- Form to be completed each time a drivers' medical certificate is renewed.

- Form verifies the medical examiner is on the FMCSA National Registry at the time driver received medical exam.

\*Note Supervisors shall only submit the employee's medical exam certificate to the CIC. The medical long form contains personal private information and shall NOT be shared.

6. Driver's Road Test; Identified as "Record & Certificate of Road Test" in the Resource Center on the CIC.

- The road test must be given by a person who is competent to evaluate and determine whether the person taking the test has demonstrated that he/she is capable of operating and loading the vehicle in a safe sufficient manner.
- The person giving the road test must be licensed for the vehicle in which the test is being given.
- The driver should be tested in the type of vehicle he/she will be certified to drive.
- The driver attempting to qualify under the regulations should be given the opportunity to study the requirements listed on the "Driver's Road Test" prior to the date the test is given.
- Prior to being certified for the road test, the driver must be able to demonstrate proper procedures for hook-up of trailers, brake lines, and lights. Also, the driver must demonstrate proper loading of equipment and cargo, load securing techniques, as well as being able to operate in a safe manner any power accessories such as winches.

7. Certification of Road Test; Identified as "Record & Certificate of Road Test" in the Resource Center on the CIC.

- This certification must be completed by the individual conducting the test.

Annual Review and Certification of Violation (Part I): Annual Driver's Certification of Violations; Identified as "Certification of Violations/Annual Review of Driving Record" in the Resource Center on the CIC.

- A driver/applicant qualified is required to furnish the Company at time of CMV driver application and at least once every twelve months, with a list of violations of motor vehicle traffic laws and ordinances (other than violations involving only parking) of which he/she has been convicted, forfeited bond, or collateral during the preceding twelve month period.
- This includes violations involving both Company and personal vehicles.

Annual Review and Certification of Violation (Part II): in the Resource Center on the CIC.

- The supervisor is required to review and certify, at least once every twelve months, the driving record of ALL drivers under his/her supervision who are qualified under the regulations. This review must determine whether the driver meets minimum requirements for safe driving, or is disqualified to drive.

CDL Drivers with less than 1 year of experience driving with CDL are required to complete Entry Level Driver training.

The review of driver qualification/documentation must be completed by the People Leader or designee.

#### **6.4 CMV DRIVER QUALIFICATION DOCUMENTATION AND RETENTION**

The Annual Driver's Certification of Violations and Review (Parts I and II) will be completed annually for each CMV Driver. The review process must be performed prior to expiration for driver to remain qualified to operate CMV.

A physical examination must be conducted every two years or earlier if determined by medical examiner findings

- Medical Merge Criteria (CDL) – Requirement for drivers applying for a CDL for the first time; renewing, upgrading or replacing their CDL to declare the Non-expected Interstate (NI) category and submit their medical examiner's certificate to their State Driver's Licensing Agency. (Current CDL drivers must declare (NI) and provide their medical examiner's certificate to their State Driver's Licensing Agency.)
- People Leaders or designee will upload all CMV qualification documentation to the Client Information Center (CIC) where they will be maintained per filing and retention periods set by FMCSA.
- Record retention requirements are maintained by Safety unless special circumstances require a retention period longer that routinely required. (i.e., legal or other special circumstances).

#### **6.5 COMMERCIAL DRIVER'S LICENSE (CDL)**

- Employees, who drive either a truck or a combination of vehicles with a gross vehicle weight rating of more than 26,001 pounds or any vehicle carrying hazardous material in placarded amounts, must be tested and be licensed for the specific type of vehicle they operate.
- All CDL applicants and drivers will be in full compliance of DOT Regulation (49 CFR Part 391) prior to applying for CDL Certification. Part 391 primarily and exclusively applies to drivers of commercial vehicles with a gross vehicle weight rating of 10,001 pounds or more.
- Testing process will include both written tests and a variety of road tests. Applicants must pass both to receive a CDL.

#### **6.6 LICENSING REQUIREMENTS AND TESTING**

**Application** - CDL Applicants must:

- Contact the state's Department of Public Safety and ask for an instruction sheet on each state's procedures regarding CDL Certifications.
- Certify that he/she meets all the qualification requirements of DOT Federal Motor Carrier's Safety Regulations pertaining to commercial vehicles with GVWR of 10,001 pounds or greater defined in the earlier sections of this procedure.
- Pass all knowledge tests for the type of motor vehicle he/she operates or expects to operate. Passing is considered 80 percent or above.
- Pass a driving test taken in a motor vehicle which is representative of the type of motor vehicle the person operates or expects to operate or provide evidence that he/she has passed a driving test administered by an authorized third party.
- Certify that the motor vehicle in which he/she takes the driving skills test is the type of vehicle that he/she will operate.
- Provide information such as full name, signature, mailing address, completed physical examination form and medical examination certificate, date of birth, sex, height, etc. to the state agency issuing the CDL.
- Certify that he/she is not subject to any disqualification, suspension, revocation, or cancellation and that the applicant does not have a driver's license from more than one state.
- Surrender his/her non-CDL License to the state upon issuance of a new CDL. When applying to transfer a CDL from one state of domicile to a new state of domicile, the applicant has no more than 30 days after establishing his/her new domicile.

**Class of Licenses** – You will need a certain type of classification depending on the type of vehicle you drive.

- Combination vehicle (Group A): Any combination of vehicles with a Gross Combination Weight Rating (GCWR) of 26,001 pounds or more provided the Gross Vehicle Weight Rating (GVWR) being towed is in excess of 10,000 pounds.
- Heavy Straight Vehicle (Group B): Any single vehicle with a GVWR of 26,001 or more pounds, or any such vehicle towing a vehicle not in excess of 10,000 pounds GVWR.
- Small vehicle (Group C): Any vehicle with A GVWR of less than 26,001 pounds used and placarded to transport hazardous materials; or any bus, commute vans and limousines designed to carry 16 or more passengers including the driver.

**Endorsements** will be needed by CDL Drivers for the following applications:

- Double or Triple Trailer Endorsements: Needed to operate vehicles pulling two or three trailers. A Class "A" License is required to operate this type of vehicle.

- Passenger Endorsement: Needed for operators of all buses used to transport passengers.
- Tank Vehicle Endorsement: Needed for operators of vehicles that transport liquids or gas in bulk.
- Hazardous Materials Endorsement: Needed for operators of vehicles transporting hazardous materials in placarded quantities.
- Air Brakes Endorsement: Needed for any vehicle equipped with air brakes.

### **Skills Test**

- Applicant must take these tests using the type of vehicle for which he/she is being licensed.
- There are three parts to the road test the applicant must take:
  - Pre-trip Inspection: Used to determine whether the driver knows if the vehicle is safe to drive. The driver may be asked to do a pre-trip inspection of the vehicle.
  - Basic Vehicle Control Test: Used to evaluate basic skills on controlling vehicle such as starting, moving forward, backward, and turning maneuvers marked out by traffic cones, lines, etc.
  - Open Road Test: Used to evaluate the ability of the driver to drive safely in a variety of on-the-road situations. The driver will drive the vehicle over the test route following instructions of the examiner.

## **6.7 PARTS AND ACCESSORIES NECESSARY FOR SAFE OPERATION OF VEHICLES**

- Any truck owned, rented, or leased and operated by the company must meet the Department of Transportation (DOT) Federal Motor Carrier Safety Regulations (FMCSR).
- Any truck owned, rented, or leased and operated by the company must be maintained in safe working order.

## **6.8 NOTIFICATION, REPORTING, AND RECORDING OF ACCIDENTS**

- All records and information pertaining to accidents involving commercial vehicles must be made available to authorized representatives of the Federal Highway Administration (FHWA) upon request.
- Report by telephone to the People Leader and Region Health and Safety if an accident involving commercial vehicle results in any of the following:
  - A fatality.
  - Bodily injury to a person who, as a result of the accident, immediately receives medical treatment away from the scene of the accident if company driver is cited.

- One or more motor vehicles incur disabling damage as a result of the accident, requiring a vehicle to be transported from the scene of the accident by a tow truck or other vehicle if company driver is cited.
- A DOT Alcohol and Controlled Substance test is required when a CDL driver operates a commercial motor vehicle and is involved in any of the three bulleted types of accidents above.
- A DOT Alcohol and Control Substance test is not required for the following events:
  - Boarding or alighting from stationary motor vehicle
  - Loading or unloading of cargo.

### 6.9 HOURS OF SERVICE AND DRIVING LOGS

Regulations regarding Hours of Service (HOS) requirements for LP are strictly enforced when applicable. Please reference the HOS appendix for details on how to ensure you are complying.

### 6.10 VEHICLE INSPECTIONS

Daily inspections must be conducted by the assigned driver or relief driver on each day a regulated vehicle is driven.

- Pre-trip inspections are walk around visual inspections to ensure vehicle is safe to drive.
- Post-trip inspections include visually inspecting the same equipment; however, they shall be documented by Company-approved means (**Electronic**). A Post-Trip Inspection Report is required to be completed **(whether a deficiency is identified or not)** and filed only when a regulated vehicle is driven as a CMV and equipment problems or safety concerns are identified during your Post Trip vehicle inspection.

Pre/Post Trip Inspections require inspection of the following equipment:

● Parking (hand) brake	● Horn	● Coupling devices
● Steering mechanism	● Windshield wipers	● Wheels and rims
● Lighting devices & reflectors	● Rear vision mirrors	● Emergency Equipment
● Tires	● Service brakes including trailer brake connections	

- Deficiencies that would affect safe operation of the vehicle must be identified and corrected before starting the trip.
  - Post-Trip Inspection Reports require the drivers and mechanics signature if repairs were made to the vehicle prior to operating the vehicle.
  - Reference the Health and Safety Manual Filing system document on the Source for retention requirements.

- Electronic copies of the Driver Vehicle Inspection Report (DVIR) will be retained for a minimum of 90 days.
- Periodic maintenance and inspections are conducted based on the mileage or frequency determined by Fleet Services or manufacturer's recommendations.
  - Maintain this inspection in the vehicle file at the facility until vehicle is sold or traded.
- Trailer inspections are conducted based on the frequency determined by Fleet Services.
  - Each trailer that is normally or occasionally towed is subject to these inspections.
- Annual Inspections
  - All DOT vehicles including power units and trailers must pass an Appendix G (FMCSA) safety inspection.
  - Keep a completed copy of the inspection report at the location where the vehicle is assigned and maintained for a period of 14 months. A copy of the documentation of the inspection must be carried in the power unit or with the trailer and may include a sticker or decal. (Varies by state.)

## **6.11 ROADSIDE/WEIGH STATION INSPECTIONS**

Inspections are conducted by specially trained third-party inspectors to ensure a safer highway environment under guidelines developed by the Commercial Vehicle Safety Alliance (CVSA).

- Drivers are required to conduct themselves professionally with enforcement officers during roadside inspections and offer documents upon request. Drivers will always be truthful when asked questions concerning their duty status, qualifications, route, vehicle, or other compliance concerns.
- When a driver is approached to undergo a roadside inspection, he/she must go immediately to the area designated by the inspection officer. If the driver believes that the designated area is unsafe for the driver and/or the inspection officer, the driver shall state his/her concern to the inspection officer in a courteous and professional manner. Once the inspection is underway, the driver shall follow the directions given by the officer and act appropriately.
- If a driver receives an inspection report they shall submit a copy of the roadside inspection report and any other supporting documentation to their People Leader within 24 hours.

Reference Appendix, DOT Drivers CMV parameters to assist in determining commercial vehicle status.

- Behavior Analysis Safety Improvement Categories (BASICs) are the CSA categories utilized to identify poor safety performers as they relate to CMVs.



- Unsafe Driving – Speeding, reckless driving, improper lane change and inattention.
- Crash Indicator – Information from state-reported crashes that meet reportable crash standards.
- HOS Compliance – Driver operating more hours than allowed under HOS regulations and falsification of record of duty status (driver’s log).
- Vehicle Maintenance – Operating an out-of-service (OOS) vehicle or operating a vehicle with inoperative brakes, lights, and/or other mechanical defects, and failure to make required repairs. Violations related to improper load securement and cargo retention.
- Controlled Substance and Alcohol – Driver failing an alcohol test, which indicates an alcohol level of .02 or greater, and operating under the influence of illegal drugs.
- Hazardous Material Compliance – Failing to mark, label, or placard in accordance with the regulations and not properly securing a package containing Hazardous Materials.
- Driver Fitness – Failure to have a valid and appropriate CDL and being medically unqualified to operate a CMV.

## **6.12 DRUG AND ALCOHOL POLICY**

Requirements pertaining to controlled substances and alcohol are outlined in the Drug and Alcohol Policy:

[Enbridge DOT Anti-Drug & Alcohol Plan – FMCSA \(Drivers\)](#)

## **6.13 DOCUMENTATION**

Application for Employment Supplement - Driver Qualification Data – JJ Keller Client Information Center

Request for Motor Vehicle Driver's Record (MVR) – JJ Keller Client Information Center

Request for Information from Previous Employer – JJ Keller Client Information Center

Driver’s Report to Employer of Traffic Conviction – JJ Keller Client Information Center

(Part I): Annual Driver's Certification of Violations – JJ Keller Client Information Center

(Part II): Annual Review of Driving Record – JJ Keller Client Information Center



Medical Exam Form – JJ Keller Client Information Center

Medical Exam Certificate – JJ Keller Client Information Center

Annual State Inspection Report

Record of Road Test – JJ Keller Client Information Center

## **7.0 TRAINING**

Personnel working in the field must be knowledgeable in this Standard and may be assigned applicable training as driven by the Safety Training Matrix.

Reference the Health & Safety training syllabi and matrices for further information and training re-certification requirements.

## **8.0 RELATED DOCUMENTS**

Enterprise Travel Management Policy

Driver's License & Driving Record Policy

Material Handling Standard

Workplace Drug & Alcohol Policy

Safety While Driving Policy

Driver's License and Driving Record Policy

Vehicle Standard

Motor Vehicle Record

## **9.0 STANDARD REVIEW**

A subject matter expert (SME) will perform a technical review of this standard every two years to determine the accuracy of the content/information. The SME shall solicit input from applicable stakeholders to ensure the effectiveness of the standard. Any suggested changes must be reviewed and approved by the designated document owner.

## **10.0 REFERENCES**

49 CFR Parts 350-399 – Federal Motor Carrier Safety Regulations

49 CFR Part 383 – Commercial Driver's License Standards; Requirements and Penalties, DOT Regulation

49 CFR Part 391 – Qualifications of Drivers and Longer Combination Vehicle (LCV) Driver Instructors, DOT Regulation

US LP/MP - HOS Requirements

---

Enbridge DOT Anti-Drug & Alcohol Plan - FMCSA (Drivers)

Transportation of Hazardous Materials



## 11.0 APPENDIX

### 11.1 MARKING OF COMMERCIAL MOTOR VEHICLES

#### 11.1.1 REQUIREMENTS- MARKINGS OF COMMERCIAL MOTOR VEHICLES

Commercial motor vehicles must display the following information:

- The legal name of the Business Unit.
  - The identification number issued by FMCSA. It shall be preceded by the letters “USDOT”.
- Size, shape, location, and color of marking must:
- Appear on both sides of the self-propelled CMV;
  - Be in letters that contrast sharply in color with the background on which the letters are placed;
  - Be readily legible, during daylight hours, from 50 feet (15.24 meters) while the CMV is stationary; and
  - Be kept and maintained in a manner that retains its legibility.

**Enbridge (U.S.) Inc., and its Subsidiaries  
US DOT Number for various US Operations**

<u>Algonquin Gas Transmission – USDOT 215925</u>	<u>North Dakota Pipeline Company LLC – USDOT 360710</u>
<u>East Tennessee Natural Gas – USDOT 217297</u>	<u>Ozark Gas Transmission – USDOT 2348901</u>
<u>Egan Hub Storage – USDOT 2348899</u>	<u>Platte Pipeline Company, LLC – USDOT 2395587</u>
<u>Enbridge Energy Limited Partnership – USDOT 113931</u>	<u>Sabal Trail Transmission, LLC – USDOT 2891616</u>
<u>Express Pipeline LLC – USDOT 2395603</u>	<u>Saltville Gas Storage Company – USDOT 2349330</u>
<u>M &amp; N Operating Company – USDOT 2348900</u>	<u>Texas Eastern Transmission – USDOT 301718</u>
<u>NEXUS Gas Transmission, LLC – USDOT 3160997</u>	<u>Vector Pipeline LP – USDOT 3659775</u>

---

### **11.1.2 RENTED COMMERCIAL MOTOR VEHICLES**

Employees operating a CMV under a rental agreement for 30 days or less must ensure rental vehicle meets the requirements outlined above.

The vehicle may display the legal trade name and USDOT number of the owner/lessor of the vehicle and the employee will carry in the vehicle the rental agreement between driver (the renting carrier) and the lessor/owner. The rental agreement must clearly show:

- Your legal name and the complete physical address of your principal place of business;
- Your USDOT number from the FMCSA. If you don't have a USDOT number, you must show the following additional information in the rental agreement:
- Information stating whether you are engaged in "interstate" or "intrastate" commerce; and
- Information showing whether you are transporting hazardous materials in the rented CMV.
- The sentence: "This lessor cooperates with all Federal, State, and local law enforcement officials nationwide to provide the identity of customers who operate this rental CMV."
- The rental agreement must be carried on the rental CMV during the full term of the rental agreement.

\*Note: Contact Fleet Safety for more information on Marking of Commercial Motor Vehicles.

## 11.2 COMMERCIAL MOTOR VEHICLE PARAMETERS

### FLOWCHART TO DETERMINE IF A COMMERCIAL MOTOR VEHICLE

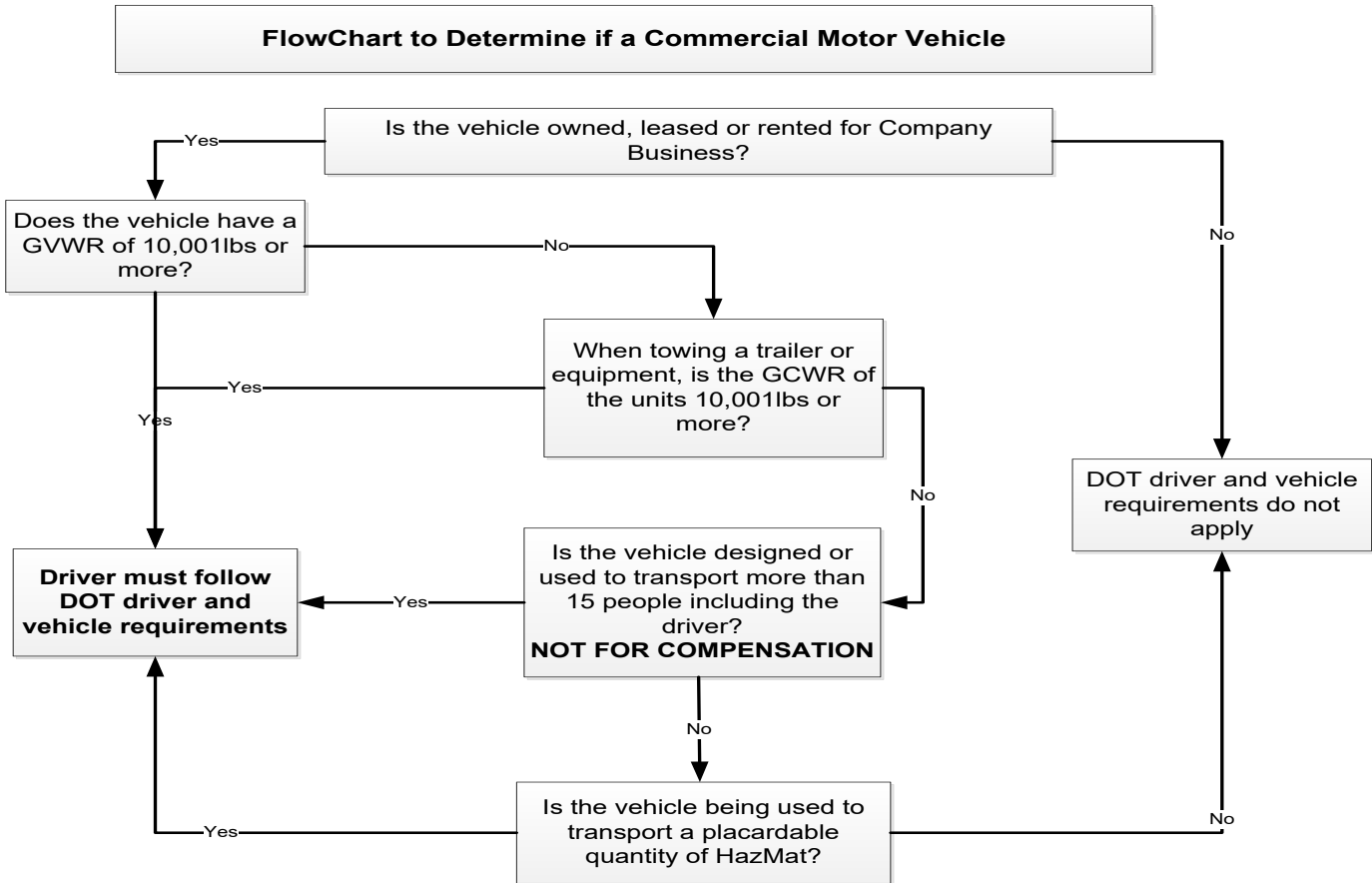

**TABLE TO DETERMINE COMMERCIAL MOTOR VEHICLE STATUS**

Vehicle Description	Commercial Motor Vehicle	License Type	Notes
Ford F-150, GVWR of 6,700 lbs without trailer	NO	Non-CDL	
Any vehicle regardless of weight rating transporting a placardable quantity of hazardous materials	YES	CDL	Driver would also need the HazMat endorsement
Ford F-150 with a GVWR of 6,700 lbs and an enclosed trailer with a GVWR of <3,300 lbs	NO	Non-CDL	If actual weight of truck is greater than 10,001lbs, the vehicle <b>IS</b> still a CMV
Ford F-150 with GVWR of 6,700 lbs pulling a trailer with a GVWR of >3,300 lbs	YES	Non-CDL	If actual weight of truck is greater than 10,001lbs, the vehicle <b>IS</b> still a CMV
Ford F-250 with a GVWR of < 10,001 lbs no trailer	NO	Non-CDL	
Ford F-250 with a GVWR of 10,000lbs pulling a trailer with a GVWR of >1,000 lbs	YES	Non-CDL	Any driver operating a F-250 connected to a trailer shall be considered a CMV Operator
Ford F-350 with a GVWR of 14,000 lbs no trailer	YES	Non-CDL	Any driver operating a F-350 due to the GVWR would be deemed a CMV Operator
Ford F-350 with a GVWR of 14,000 lbs pulling a trailer with a GVWR of 12,500 lbs	YES	CDL	Any driver operating a F-350 and trailer with a combined GVWR >26000 lbs would need a CDL

## **11.3 HOURS OF SERVICE REQUIREMENTS**

### **11.3.1 INTRODUCTION**

Enbridge commercial motor vehicle operators are required to maintain Hours of Service via an Electronic Logging Device (ELD) unless other specific exemptions have been identified and clearly communicated. (Ex. Utility Service Exception for GTM)

### **11.3.2 PURPOSE AND SCOPE**

Hours of Service via an ELD are required of each CMV operator, unless they can meet one of the following exceptions:

- Driver operates a CMV older than model year 2000, as identified by its vehicle identification number.
- Driver not required to maintain record of duty status (RODS) by operating under the 150 air mile radius exception
- Driver is not required to maintain record of duty status (RODS) more than 8 days in a rolling 30- day period.
- Driver of a commercial motor vehicle is used to respond to a pipeline emergency, if such regulations would prevent the driver from responding to an emergency condition requiring immediate response.

An immediate response is any condition that, if left unattended, is reasonably likely to result in immediate serious bodily harm, death or substantial damage to property.

### **11.3.3 RESPONSIBILITIES**

People Leaders or designee shall:

- Ensure that HOS requirements are followed and enforced daily.
- Adjust work assignments to ensure that all drivers comply with Hours of Service
- Counsel and correct drivers when notified that violations are discovered through audits or roadside inspections
- Assist drivers with edits as appropriate
- Monitor drivers' activities for compliance
- Ensure each (CMV) operator required to utilize an ELD does not:
  - Tamper with, or deliberately damage, the device
  - Intentionally submit false information

- Make changes in the system that create a false record
- Ensure the following ELD database assignments for employees are completed:

Violation of the aforementioned items regarding ELDs and the platform used to access Hours of Service information may result in disciplinary action in accordance with the Company's disciplinary policies.

Support Personnel shall:

Audit logs and monitor ELD activities at a frequency specified by People Leader to ensure that they are completed in an acceptable amount of time. Specifics to be reviewed are:

- Drivers complying with hours of service requirements
- Ensure all miles are accounted for and assigned to the appropriate Driver(s) in the system. (Unassigned miles are generally caused by drivers forgetting to log in/out.
- Drivers in the system identified as having unassigned miles, which generally are caused by drivers forgetting to log in.
- Annotate each change or addition to a record
- Problem areas a driver may have in properly electronically logging into the system
- Provide direct support when areas of concern arise
- Notifying Supervisors when violations are discovered during auditing or roadside inspections

Enbridge is ultimately responsible for resolving unassigned driving time and required to monitor. It is important that proper maintenance is given to all logs by checking on them at least once a day.

LP Drivers utilizing an ELD shall:

- Log in at the beginning of the tour, using their assigned credentials.
  - Review, and accept or deny any unassigned driving time on the device at time of login.
  - Accept unassigned driving time if their actions led to the unassigned driving time.
  - Create off-duty logs for any days they are off-duty since logging out.
- Make manual duty status changes at the time the duty change takes place.
- Find a safe parking location and stop operating the vehicle when alerted by the ELD.
- Make location entries, when requested by the device.
- Comply when an HOS Limit. (8-hour/30-minute break, 11 driving, on-duty 14



consecutive, 60/70) has been reached.

- Review proposed edits and approve the edit only if the edit is appropriate. If the edit is not appropriate, the driver is to contact the supervisor that initiated the edit and explain why the edit is not appropriate.

Examples:

- Driver forgot to log in
- Driver forgot to enter a duty change when it occurred (correcting the time a duty change took place)
- After traveling and being off duty for 10 consecutive hours or more
- Driver forgot to log out
- Adding on duty hours that were not entered into the system through the onboard device
- Enter a comment any time an exemption or exception is used.
- Enter a comment any time a limit is exceeded.
- Certify and submit the record within 72 hours
- Alternate: Certify and submit the records at the end of current assignment. Log out upon completion of tour.
- Make edits and annotations as needed to correct for errors and omissions. All edits must include a comment stating the reason the edit was necessary.
- Review their ELD records, edit and correct inaccurate records, enter any missing information and certify the accuracy of the information.
- Always keep their log current to the last duty change
- Complete form and manner log entries at the appropriate time and comply with HOS limits
- Submit accurate logs
- Submit logs within company-determined limits

Use the following special driving categories only when appropriate

- Personal use: To only be used only when the driver is relieved from work and all responsibility for performing work by the Enbridge even if vehicle/combination is laden. Personal use does NOT reduce a driver's or Enbridge's responsibility to operate a CMV safely. Misuse of this special driving category will be considered deliberately creating a false log.
- Yard move: To only be used only when the vehicle is being operated in a facility that the public does not have access into due to gates or signs. Misuse of this special driving category will be considered deliberately creating a false log.

Carry the following in-vehicle information regarding ELDs

- ELD user manual
- Instruction sheet describing how to transfer data (including step-by-step instructions for getting the driver's records to an enforcement official)
- Instruction sheet describing what to do when an ELD malfunctions

- Blank paper logs to last at least eight days. (If a driver continues to record their hours of service on a paper log beyond 8 days risks being placed out of service.)

If an ELD malfunctions:

- Notify their ELD system administrator in writing within 24 hours
- Correct any behaviors that they have been counseled on
- Present HOS Logs as requested during Roadside Inspections

Roadside Inspections

- It is the driver's responsibility to provide the officer with the requested records. Be prepared to also show the officer a supply of at least 8 blank paper logs.
- The officer only has the right to view your current and 7 previous days' logs.
- The officer may wish to remove your device from your view while they inspect your logs. It is suggested that you "LOCK" your device so that other areas of your ELD and your device cannot be viewed by anyone not authorized to do so.

### 11.3.4 RULES

11-Hour Driving Rule

- Drivers cannot drive for more than 11 hours following 10 consecutive hours off duty. All time spent at the driving controls of a CMV is considered driving time.

14-Hour On Duty Rule

- A driver cannot drive after the 14<sup>th</sup> consecutive hour after coming on duty. After the 14<sup>th</sup> hour, a driver cannot drive again until he/she has 10 consecutive hours of rest.

30-Minute Rest-Break Rule

- Drivers can remain "on duty" for their breaks and not have to take a break until completing eight hours of continuous driving time.

The rest-break must be logged as off duty. If a driver has not taken a rest-break and has been on duty for 8 hours of continuous driving, the driver will complete a **30-minute** off duty rest-break before driving. By doing so, the driver will remain in compliance.

### 11.3.5 LIMITS

70-Hour/8-Day Limit

- The company follows the 70-hour/8-day schedule. A driver cannot drive after having been on duty for 70 hours in any 8 consecutive days.

34-Hour Restart

- Any period of 8 consecutive days may be ended with the beginning of an off-

duty period of 34 or more consecutive hours. Upon completion of the 34-consecutive hours off duty, the driver's hours worked for the previous 8 days goes to "0" and the driver has a full 70 hours available.

#### On Duty Time

- All time from the time a driver begins to work or is required to be in readiness to work until the time he/she is relieved from work and all work responsibility is considered on duty time. Work for any entity, regardless of whether the employer is a carrier, is considered on duty time. On duty time, defined by FMCSA, includes the following: All time at a plant, terminal, facility, or other property, of a motor carrier or shipper, or on any public property, waiting to be dispatched, unless the driver has been relieved from duty by the motor carrier.
- All time inspecting, servicing, or conditioning any CMV at any time.
- All driving times.
- All time, other than driving time, in or upon any CMV except time spent resting in a sleeper berth, time spent resting in or on a parked vehicle, and up to 2 hours spent riding in the passenger seat of a moving property-carrying vehicle immediately before or after spending at least 8 consecutive hours in a sleeper berth.
- All time loading or unloading a CMV, supervising, or assisting in the loading or unloading, attending a commercial motor vehicle being loaded or unloaded, remaining in readiness to operate the CMV, or in giving or receiving receipts for shipments loaded or unloaded.
- All time repairing, obtaining assistance, or remaining in attendance upon a disabled CMV.
- All time spent providing a breath sample or urine specimen, including travel time to and from the collection site, in order to comply with alcohol and drug testing requirements.
- Performing any other work in the capacity, employ or service of a motor carrier.
- Performing any compensated work for a person who is not a motor carrier.

*For drivers, on duty time would also include:*

- When arriving at a satellite location;
- Upon arrival at the office/work location; or
- Upon boarding an aircraft (or other commercial transportation).

#### Travel Time

- When a property-carrying CMV driver at the direction of the motor carrier is traveling, but not driving or assuming any other responsibility to the carrier, such time must be counted as on duty time unless the driver is afforded at least 10 consecutive hours off duty when arriving at destination, in which case he/she must be considered off duty for the entire period.
- Drivers will log on duty and then if the driver is able to go directly to off duty for a period of 10 consecutive hours once they arrive at their destination, the driver will log the entire time spent traveling as off duty.

### 11.3.5 EXCEPTIONS

#### Meal Stop Exception

- The company relieves the driver of all duty and responsibility for the care and custody of the vehicle, its accessories, and any cargo it may be carrying; and
- For the duration of the stop, the driver must be at liberty to pursue activities of his/her own choosing and to leave the premises where the vehicle is situated.

#### Driver Short-Haul Exception

A driver is not required to create a log or use an ELD, or comply with the 30-minute break requirement, and is exempt from the 14-hour limit, if the following criteria are met:

- The driver stays within a 150 air-mile radius of the normal work reporting location.
- The driver returns to that work reporting location at the end of each duty tour; and
- The driver does not drive after the 14th hour after coming on duty on 5 days of any period of 7 consecutive days, or after the 16th hour after coming on duty on 2 days of any period of 7 consecutive days (a valid 34-hour restart may be used to begin a new 7- consecutive-day period).
  - Drivers claiming this exemption must comply with the 10-hour off duty rule, the 11-hour driving rule, and the 60/70-hour limit, and must not use the 100 air-mile radius exception, the sleeper- berth option, or the 16-hour short-haul exception.

Enbridge will maintain time records for 6 months showing the time the driver reports for duty each day, the total number of hours the driver is on duty each day, and the time the driver is released from duty each day (and the total time for the preceding 7 days for drivers used for the first time or intermittently).

One hundred fifty miles are equivalent to 172.6 statute miles

#### Personal Conveyance

- The current guidance from FMCSA requires that the driver be relieved from work and all responsibility for performing work to be in an off-duty status. Specifically, it applies when traveling:
- To and from the place of employment (e.g., the normal work reporting location), and
- Short distances from a driver's end route lodgings to restaurants in the vicinity of such lodgings.

Operation of Laden CMVs and CMVs operated by drivers who have been placed out of service (OOS) for HOS violations are prohibited.

#### Disaster Relief from Regulations

DOT regulations do not apply if the driver operating the CMV is providing emergency relief during an emergency.

- The exemption provided by this rule is effective only when an emergency has been declared by the President of the United States, the governor of a state, or their authorized representatives having authority to declare emergencies, or the FMCSA Field Administrator.
- The exemption shall not exceed the duration of the motor carrier's or driver's direct assistance in providing emergency relief, or 30 days from the date of the initial declaration of the emergency or the exemption from the regulations by the FMCSA Field Administrator, whichever is less.

When an emergency has been declared by the President of the United States, or the governor of a state, or their representative(s), then we will be relieved from having to maintain adherence to the DOT HOS regulations, but will still be obligated to operate our vehicle(s) in a safe, reasonable and professional manner.

On duty time shall be considered emergency communication assistance. ELD entries should still be accurate as to actual HOS worked; entries shall always be entered into the ELD, with the Disaster Relief Exception in the notes section.

ELD remarks will be used to explain these types of moves. **DECLARED EMERGENCY** or **DISASTER AREA BY GOVERNOR** or **PRESIDENT** will be added to each duty status change remark.

#### Pipeline Emergencies

- In the case of a pipeline emergency, such conditions include (but are not limited to) indication of an abnormal pressure event, leak, release or rupture.

### 11.3.6 MALFUNCTIONS

A malfunction is any situation involving the device being unable to capture, process, store, or present the required HOS data. If the device malfunctions, the driver is to:

- Notify the People Leader immediately
- Immediately reconstruct the current and previous seven days' logs using (any combination is acceptable):
  - Blank logs
  - Printouts
  - Blank logs
  - The device display

### 11.3.7 SUPPORTING DOCUMENTS

A supporting document is a document, in any medium, generated or received by a motor carrier in the normal course of business that can be used, as produced or with additional identifying information, by the Company and enforcement official to verify the accuracy of a driver's record of duty status. Below are five categories of supporting documents that must be retained and if requested made available during an audit:

- Shipment paperwork (bills of lading, shipment invoices, delivery receipts, etc.)
- Dispatch and trip records, or the equivalent
- Expense receipts related to any on duty not driving time (such as fuel receipts)
- Electronic mobile communication/tracking system records
- Payroll and settlement records or an equivalent document that indicates payment to a driver

A maximum of 8 supporting documents per driver, per day will be submitted and retained. If more than 8 documents are available, the first and last supporting document obtained during the 24-hour period will be retained along with 6 additional supporting documents.

## Change Log

Section	Version 2.0	Version 2.1
6.8		Updated terminology from incident and investigation to event and analysis.
Entire document		Clerical corrections including spelling, grammar, and document names.

<End of Document>



**ENBRIDGE<sup>®</sup>**  
**Standard**

---

**Confined Space -  
Canada**

---

**Effective Date:** 2019-03-30  
**Version #:** 3.1  
**Version Date:** 2024-03-28

---



This page intentionally left blank





**Document Version Register**

Version Number	Version Date	Approved By	Section Number and Title	Details of Version
1.0	2019-03-30	Sean Evans	Whole Document (New Standard)	This is the new H&S standard that was developed as part of the LP   MP Safety Manual Transition Project
1.1	2019-10-31	Sean Evans	6.4, 6.9.2	See Change Log
1.2	2020-06-01	Sean Evans	2.0, 5.0	Alignment with Contractor Safety Specifications
1.3	2021-06-01	Murray Evenson	9.0	Updated section 9 to reflect the appropriate review process
2.0	2022-08-30	Murray Evenson	6.13	Added section 6.13 'External Floating Floating Tank Roofs'
3.0	2023-09-21	Jeff Safioles	4.0, 5.0, 6.1, 6.2, 6.4.5, 6.6, 6.8.2, 6.10, 6.13, 7.0, 9.0	Updated the following section to meet or exceed amendments to the Canada Labour Code Part II, Canada Occupational Health & Safety Regulations, Part XI.
3.1	2024-03-28	Troy Croft	All sections 6.2, 6.8.3	Clerical corrections. Alignment with Management System Framework - Event Analysis.



This page intentionally left blank

---

## Table of Contents

1.0	Purpose .....	3
2.0	Scope .....	3
3.0	Prerequisite .....	3
4.0	Definitions & Acronyms .....	3
5.0	Roles & Responsibilities .....	7
6.0	Standard – Specific Requirements .....	12
6.1	Confined Space Inventory Requirements .....	12
6.1.1	Spaces Included in the Inventory .....	12
6.2	Hazard Assessment .....	13
6.3	Control of Hazards .....	15
6.4	Types and Classifications of Confined Spaces .....	16
6.4.1	Low Hazard Atmosphere (Restricted Space) .....	17
6.4.2	Moderate Hazard (Non-IDLH) Atmosphere .....	17
6.4.3	High Hazard (IDLH) Atmosphere .....	18
6.4.4	Temporary Reclassified Space .....	18
6.4.5	Confined Space Requirements .....	19
6.5	Trenches and Excavations .....	20
6.6	Confined Space Entry Plan .....	20
6.7	Pre-Entry Meeting .....	21
6.8	Confined Space Entry Permit .....	22
6.8.1	Confined Space Permit Roles .....	23
6.8.2	Terminating an Entry .....	24
6.8.3	Permit Document Copies .....	25
6.9	Work Practices .....	25
6.9.1	Preventing Unauthorized Entry .....	25
6.9.2	Atmospheric Testing/Monitoring .....	26

---

6.9.3	Inerting .....	27
6.9.4	Ventilation Requirements.....	28
6.9.5	Hot Work.....	30
6.9.6	Isolation Requirements.....	30
6.9.7	Top-Entry Confined Spaces .....	31
6.10	Confined Space Rescue.....	31
6.10.1	Rescue Plan .....	32
6.10.2	Rescue Equipment .....	33
6.11	Confined Space Closure Requirements.....	33
6.12	Confined Space Package.....	34
6.13	External Floating Tank Roofs .....	34
7.0	Training.....	35
7.1	Authorized Entrant.....	35
7.2	Attendant/Safety Watch.....	35
7.1	Rescue Personnel .....	35
8.0	Related Documents.....	36
9.0	Records Retention.....	36
10.0	Standard Review .....	36
11.0	References .....	36
12.0	Appendix.....	38
12.1	Identification of a Confined Space.....	38
12.2	Confined Space Entry Permit .....	39
	Change Log.....	41

---

## **1.0 PURPOSE**

The purpose of this standard is to ensure that Enbridge Workforce understands the hazards and requirements associated with confined spaces.

Enbridge will inform contractors and subcontractors of confined space locations, elements, precautions, procedures, and coordinate all entries into confined spaces.

## **2.0 SCOPE**

This Standard applies to all employees within Liquids Pipelines and Projects in Canada who are involved in confined space work.

Contractors and subcontractors shall comply with Enbridge health and safety requirements set out in this standard, as articulated within applicable contractor safety specifications. If a contractor or subcontractor has a health and safety standard or policy materially different from Enbridge's, the contractor/subcontractor shall follow the most stringent requirement. Contractors and subcontractors are still obligated to meet the requirements of all applicable laws related to this standard.

In the event a contractor's or subcontractor's standard exceeds the requirements of this standard, Enbridge may, in its sole discretion, choose to adopt the contractor's or subcontractor's standard for any given contract or work order.

## **3.0 PREREQUISITE**

Atmospheric Monitoring Standard

Control of Hazardous Energy Standard

Emergency Preparedness- Personal Safety Standard

Fall Protection Standard

Hazard Assessment Elimination & Control Standard

Hot Work and Ignition Sources Standard

Immediately Dangerous to Life and Health Atmospheres Procedure

Personal Protective Equipment Standard

Respiratory Protection Standard

## **4.0 DEFINITIONS & ACRONYMS**

*Acceptable Entry Conditions* - the conditions that must exist in a confined space to allow entry and to ensure that workers involved with a confined space entry can safely enter and exit into and

work within the space. Prior to an entry, all access points for entry and exit will need to be determined.

*Blanking* – isolation method for the absolute closure of piping that involves inserting a physical barrier through the cross-section of pipe so material is prevented from flowing past that point. Blanks shall be of sufficient rating to withstand the highest possible pressure that may result.

*Blinding* – isolation method for the absolute closure of piping that involves disconnecting a pipe and attaching a physical barrier to the end so material is prevented from flowing out of the pipe. Blind flanges used for this purpose shall be of sufficient rating to withstand the highest possible pressure that may result.

*Confined space* - an enclosed or partially enclosed space that

- (a) Is not designed or intended for continuous human occupancy except for the purpose of performing work,
- (b) Has a limited or restricted means of access and egress or an internal configuration that could complicate provision of first aid, evacuation, rescue or other emergency response, and
- (c) May become hazardous to any person entering it owing to
  - (i) Its design, construction, location or atmosphere,
  - (ii) The materials or substances in it, or
  - (iii) Any other conditions relating to it

*Confined Space Attendant* - a qualified worker who is stationed outside one or more confined spaces who monitors the authorized entrants and who performs all attendants' duties assigned in the employer's confined space program.

*Confined Space Authorized Entrant* - a qualified worker who is authorized by the employer to enter a confined space.

*Confined Space Entry Coordinator* – an Enbridge employee or representative from the work group who is hiring a contractor to perform confined space entry. The coordinator may or may not be onsite at the time of entry. The purpose of this role is to communicate and coordinate as required, the transfer of available information on the confined space, planning, isolation, hazard assessments, etc. with contractors, operations and projects.

*Emergency* - any occurrence (including any failure of hazard control or monitoring equipment) or event internal or external to the confined space that could endanger authorized entrants.

*Engulfment* - the surrounding and effective capture of a person by a liquid or finely divided (flowable) solid substance that can be aspirated to cause death by filling or plugging the

respiratory system or that can exert enough force on the body to cause death by strangulation, constriction, or crushing.

*Entry* - the action by which a qualified worker passes through an opening into a confined space. Entry includes ensuing work activities in that space and is considered to have occurred as soon as any part of the authorized entrant's body breaks the plane of an opening into the space.

*Entry Permit* - document that allows and controls entry into a confined space.

*Entry Supervisor* – is the qualified worker who is responsible for confined space entry and determining if acceptable entry conditions are present at a confined space where entry is planned, overseeing entry operations, and for terminating entry as required.

*Flammable Atmosphere* - any atmosphere that contains 10% or more of the Lower Explosive Limit (LEL), or Lower Flammable Limit (LFL) for any substance.

*GDL* – Governance Documents Library

*Hazardous Atmosphere* - An atmosphere which exposes an individual to a risk of injury, illness, disablement, or death due to one or more of the following causes:

- A flammable gas/vapor concentration in excess of 10% of its LEL
- An atmospheric oxygen concentration below 19.5% or above 23%.
- An atmospheric concentration of any substance above the exposure limits established by the governing regulatory body or as indicated on the Safety Data Sheet (SDS)
- Airborne combustible dust at a concentration that meets or exceeds its LFL;  
Note: This concentration may be approximated as a condition in which the dust obscures vision at a distance of 5 feet (1.52 m) or less.

*High Hazard (IDLH) Atmosphere* – an atmosphere that may expose a worker to risk of death, incapacitation, injury, acute illness or otherwise impair the ability of the worker to escape unaided from a confined space, in the event of a failure of the ventilation system or respirator.

*Hot Work* - Any process that can be a source of ignition when flammable material is present or can be a fire hazard regardless of the presence of flammable material.

*Immediately Dangerous to Life and Health (IDLH) Atmosphere* - An atmospheric concentration of any toxic, corrosive or asphyxiant substance that poses an immediate threat to life or would cause irreversible or delayed adverse health effects or would interfere with an individual's ability to escape from a dangerous/hazardous atmosphere.

*Inerting* - the displacement of the atmosphere in a confined space by a non-combustible gas (such as nitrogen) to such an extent that the resulting atmosphere is non-combustible.

Note: This procedure produces an IDLH oxygen-deficient atmosphere.

*Isolated* - Sources of energy have been disconnected or controlled.

*Isolation* - the process by which a confined space is removed from service and completely protected against the release of energy and material into the space by such means as: blanking or blinding; misaligning or removing sections of lines, pipes, or ducts; a double block and bleed system; lockout or tagout of all sources of energy; or blocking or disconnecting all mechanical linkages.

*LOTO* – lockout tagout

*Low Hazard Atmosphere* - an atmosphere which is shown by pre-entry testing or otherwise known to contain clean respirable air immediately prior to entry to a confined space and which is not likely to change during the work activity, as determined by a qualified worker after consideration of the design, construction and use of the confined space, the work activities to be performed, and all engineering controls.

*Lower Explosive Limit (LEL)* - The lowest concentration (percentage) of a gas or a vapor in air capable of producing a flash of fire in presence of an ignition source (arc, flame, heat). At a concentration in air below the LEL there is not enough fuel to continue an explosion. Concentrations lower than the LEL are "too lean" to explode but may still burn with great heat and light. Exact values can be found on product's SDS.

*LFL* – Lower Flammable Limit

*Moderate Hazard (Non-IDLH) Atmosphere* –an atmosphere that is not clean respirable air but is not likely to impair the ability of the worker to escape unaided from a confined space, in the event of a failure of the ventilation system or respirator.

*Oxygen Deficient Atmosphere* - an atmosphere containing less than 19.5% oxygen by volume.

*Oxygen Enriched Atmosphere* - an atmosphere containing more than 23% oxygen by volume.

*PPE* – Personal Protective Equipment

*Prohibited Condition* - any condition in a confined space that is not allowed by the permit during the period when entry is authorized.

*Qualified* - one who, by possession of a recognized degree, certificate, or professional standing, or who by knowledge, training and experience, has successfully demonstrated their ability to solve or resolve problems relating to the subject matter, the work, or the project.

*Rescue Team* - the qualified personnel designated to rescue workers from confined spaces.

*Retrieval system* - the equipment (including a retrieval line, chest or full-body harness, wristlets or anklets, if appropriate, and a lifting device or anchor) used for non-entry rescue of persons from confined spaces.

*SABA* – Supplied Air Breathing Apparatus



SCBA – Self-Contained Breathing Apparatus

SDS – Safety Data Sheet

SWP – Safe Work Permit

*Toxic Atmosphere* – an atmospheric concentration of any substance above the exposure limits established by the governing regulatory body or as indicated on the SDS.

## **5.0 ROLES & RESPONSIBILITIES**

Enbridge Management and Contractor Management as articulated within the applicable contractor safety specifications shall:

- Ensure compliance with all Applicable Legislation and Enbridge requirements including, but not limited to:
  - ensuring work is conducted in accordance with this Standard, Confined Space Entry Permit, Entry Plan and Hazard Assessments, and any procedures established as a result of this Standard
  - ensuring an Entry Supervisor is assigned for each confined space entry
  - ensuring all Workers involved in Confined Space work are qualified and have completed applicable Confined Space training
  - ensuring Confined Space rescue plans are developed prior to an entry
  - ensuring all required documentation applicable to Confined Space entry is developed, completed and maintained, in accordance with Enbridge requirements and applicable Legislation
  - ensuring all resources (e.g., personnel, equipment, personal protective equipment (PPE)) required for each Confined Space Entry are readily available
  - ensure all workers who are on a site where an actual or potential confined space exists, is trained in the recognition and identification of a confined space.
  - ensure that contractors are informed of the hazards and controls associated with confined space entries.

Enbridge Operations shall:

- Identify all existing permanent confined spaces at their physical locations
- Identify potential confined spaces created by work (e.g. pipe entry during cut out work)
- Maintain a written electronic database inventory of existing Confined Spaces at the Enbridge Locations they manage (e.g., at assigned Worksites; or for a Region)
- Review and update the inventory of confined spaces at least once every 3 years, to verify accuracy
- Ensure compliance with the signage requirements for existing permanent confined spaces

- 
- Coordinate contractor confined space entries on their sites with the work group who is performing the work as required
  - Follow all procedures and standards when performing a confined space entry
  - Maintain communications with the contractor throughout the planning, execution and completion of confined space activities.
  - Debrief the contractor at the conclusion of the entry operations regarding the confined space program followed and regarding any hazards confronted or created in confined spaces during entry operations.

Enbridge Projects shall:

- Identify all confined spaces for their project work
- Coordinate all confined space entries with Operations for sites Operations has ownership of
- Coordinate contractor confined space entries on their sites with the work group who is performing the work
- Ensure compliance with the signage requirements for confined spaces
- Follow all procedures and standards when performing a confined space entry
- Maintain communications with the contractor throughout the planning, execution and completion of confined space activities.
- Debrief the contractor at the conclusion of the entry operations regarding the confined space program followed and regarding any hazards confronted or created in confined spaces during entry operations.

Entry Coordinator for Contractors shall:

- Conduct the planning for a confined space entry.
- Communicate and coordinate with contractors when contractors are performing a confined space entry.
- Coordinate the planning of the confined space entry
- Provide the Permit Issuer with adequate notice of intended entry to review scope, hazards and confined space documentation.
- Communicate with Operations
- Communicate with the contractor

- Communicate with the entry supervisor (may be the same person)
- Ensure all information on the confined space is obtained from Operations and provided to the contactor and entry supervisor
- Coordinate isolation with Operations if applicable
- Review the contractor's confined space entry program/procedures applicable to the work
- Review the contractor's rescue plan
- Ensure all policies and procedures are followed

Note: The individual performing this role should be from the work group that is hiring the contractor. The role does not need to be onsite during any time of the actual confined space entry.

Confined Space Attendant/Safety Watch at a minimum shall:

- Attend and participate in the confined space Pre-Entry Meeting
- Review the entry and rescue procedures, being aware of all confined space entry permit and hazard assessment requirements and ensuring all requirements are followed
- Be aware of the hazards of the confined space being entered
- Be aware of the signs and symptoms of exposures and the possible behavioral effects or other effects of exposure
- Ensure they have an effective means of constant communication with the workers entering the confined space, the emergency rescue personnel and the Entry Supervisor at all times
- Ensure initial and ongoing air testing occurs, as required, and the test results are recorded on the confined space entry permit
- Ensure entry points are kept clean and clear
- Control access to the confined space and prohibit entry to unauthorized workers
- Track and record on the confined space entry permit, all personnel entering and exiting a confined space, and control the number of authorized entrants within the space as required by the confined space entry permit
- Be aware of hazardous, prohibited or unacceptable conditions that require evacuation of the space
- Maintain communication with the permit receiver and notify them immediately if unacceptable conditions have developed.

- Be prepared to initiate evacuation from the space, as necessary, due to actual or potential hazards (this could include hazards within the space and also in the vicinity of the space that could affect the health and safety of workers)
- Ensure the space has been completely evacuated in the event of an emergency
- Request rescue and other emergency services when necessary, e.g., as soon as it is determined that workers in a confined space may need assistance to evacuate; or, if a situation arises outside the confined space that could endanger the workers inside or near the confined space
- Not enter a confined space for any reason and never leave the entrance to a confined space, unless relieved by another designated and qualified attendant
- Not enter the space to perform rescue operations, if qualified for rescue work in accordance with the rescue procedure for that confined space, unless they have been relieved by another attendant
- Not perform other duties which might interfere with their primary duty to monitor and protect the authorized entrants working in the space, unless they are performing non-entry rescue in accordance with the rescue procedure
- Verify that no person is inside the confined space before it is closed off, and ensure proper signage/barricades are in place to prevent unauthorized entry into the confined space prior to leaving the entrance of a confined space

Entry Supervisor at a minimum shall:

- Ensure all confined space entry and regulatory requirements are met prior to the confined space entry permit being issued.
- Verify compliance with the requirements on the confined space entry permit
- Ensure all workers are qualified to perform their assigned tasks and roles
- Know the hazards that may be faced during entry work, including information on the potential modes of exposure, plus the signs, symptoms and consequences of different exposures
- Ensure a hazard assessment is completed prior to entry and review the hazard assessment with the workers
- Conduct the confined space Pre-Entry Meeting
- Conduct and oversee the work in accordance with the Pre-Entry Meeting
- Ensure workers follow the requirements set out during the Pre-Entry Meeting

- 
- Ensure adequate steps have been taken to eliminate and/or control all present or potential hazards
  - Verify hazard controls are implemented and effective
  - Ensure all required atmospheric monitoring and testing has been completed as required by the hazard assessment and confined space plan and is properly documented
  - Ensure that rescue personnel, plans, and equipment are in place if applicable
  - Ensure there is a suitable means of communication among workers
  - Ensure that acceptable conditions are maintained for the duration of the entry work and that any requirements or status changes are communicated to the next entry supervisor if applicable
  - Terminate the confined space entry and permit if conditions warrant termination

Note: this role can be either an Enbridge employee or contractor who is involved with the entry, but are not an entrant performing work. However, a contractor Entry Supervisor cannot be the approver on the Confined Space Permit. The approver will be either operations or projects.

Authorized Entrant at a minimum shall:

- Attend and participate in the confined space Pre-Entry Meeting entry meeting
- Review the entry and rescue procedures, being aware of all confined space entry permit and hazard assessment requirements and ensuring all requirements are followed
- Be aware of the hazards of the confined space being entered
- Immediately notify the Entry Supervisor when they do not feel qualified to perform a task or assigned duty
- Conduct work as directed by the Entry Supervisor, and in accordance with company requirements
- Alert the Entry Supervisor when a hazard has not been adequately controlled
- Be aware of the signs and symptoms of exposures and the possible behavioral or other effects
- Maintain communication with the attendant and immediately notify the attendant if an emergency or a hazardous, prohibited or unacceptable condition requires evacuation of the confined space
- Exit the space as quickly as possible when any of the following occurs:
  - An emergency

- The attendant gives the order to evacuate the space
- A hazardous, prohibited or unacceptable condition is detected
- An evacuation alarm is activated
- Wear/use the required equipment (e.g., PPE, respiratory protection equipment, rescue equipment) properly, in a safe manner and at all times
- Know the limitations of equipment used to control hazards related to confined space entry work
- Sign in and sign out of the confined space with the attendant

Rescue Personnel at a minimum shall:

- Ensure all retrieval equipment is in good working order
- Ensure that the proper rescue equipment is readily available and in close proximity to the confined space.
- Write or be involved in the writing and review of the confined space rescue plan
- Review the confined space and understand the hazards and controls
- Participate in the Pre-Entry Meeting at a minimum when work is being conducted in a High Hazard (IDLH) Atmosphere Confined Space

## **6.0 STANDARD – SPECIFIC REQUIREMENTS**

### **6.1 CONFINED SPACE INVENTORY REQUIREMENTS**

A confined space inventory must be developed and maintained at the work location. The confined space inventory document is owned by Regional Operations and must be :

- Retained onsite according to Enbridge record retention policies.
- Updated as processes, operations, equipment and other circumstances change.
  - This includes any modifications to any of these that may create or alter a confined space.
- Reviewed every three years by Regional Operations. This review should consider:
  - If all existing permanent confined spaces on the worksite have been identified.
  - If all identified spaces fit the criteria of a Confined Space.
- A Hazard Assessment is required to make a final judgment on whether a space fits the technical criteria for a confined space.

#### **6.1.1 SPACES INCLUDED IN THE INVENTORY**

The inventory will contain all spaces that a worker may enter and any space that has been assessed. As spaces are assessed the inventory should then clearly indicate whether:

- The space fits the criteria of a Confined Space and will be subject to this standard for worker entry, or
- The space has been deemed to fall outside the criteria of a Confined Space.

Note: Spaces can be “grouped” and dealt with as a “type of space” for the purposes of the inventory and hazard assessment and procedures if they have the same configuration, function, and hazards.

## **6.2 HAZARD ASSESSMENT**

A Hazard Assessment, e.g., a Job Hazard Assessment (JHA) or a Field Level Hazard Assessment (FLHA) in combination with a Confined Space Permit, and a rescue plan is required before entering a confined space.

When completing a hazard assessment for a confined space, a qualified worker is responsible for identifying and assessing existing and potential hazards specific to the work activity and related job tasks that may exist due to the design, construction, location, use or contents of the confined space that may develop while work is done inside the confined space.

If two or more confined spaces are of similar construction and present the same hazards, their confined space hazard assessments may be recorded in a single document, but each confined space shall be clearly identified in the assessment.

The confined space hazard assessment must also consider specified risks including:

- the conditions which may exist prior to entry due to the confined space's design, location or use, or which may develop during work activity inside the space, and
- the potential for oxygen enrichment and deficiency, flammable gas, vapour or mist, combustible dust, other hazardous atmospheres, harmful substances requiring lockout and isolation, engulfment and entrapment, physical and configuration hazards, emergency response limitations, and other hazardous conditions.

Factors to be considered in the confined space hazard assessment include:

- Hazardous atmospheres either as a normal characteristic of the space or as the product of the required work processes to be conducted in the space:
  - Oxygen Deficiency or Enrichment: Oxygen deficiency may be caused by consumption by workers, oxidation (rusting) process, burning, welding, bacteria, or by the absorption by chemicals or products. An oxygen deficient atmosphere is one that contains less than 19.5% oxygen. Oxygen enrichment may be caused by leaking of

oxygen into the space or generation by chemical processes. An oxygen enriched atmosphere is one that contains more than 23% oxygen.

- o Asphyxiates: Inert gases can dilute or displace oxygen below a safe level (e.g., methane, carbon monoxide, carbon dioxide, nitrogen) during purging or by leaking into the confined space due to improper isolation and lockout.
  - o Toxicity: Gases (H<sub>2</sub>S, Methane, CO, etc.), vapours, dusts, or fumes that have a poisonous effect from operations such as cleaning, painting, coating, etc., or from gases like methane or H<sub>2</sub>S leaking into the confined space. Carbon monoxide may be generated by internal combustion engines within the confined space or running near air intakes for the ventilator in use. A toxic atmosphere is an atmospheric concentration of any substance above the exposure limits established by the governing regulatory body or as indicated on the SDS.
  - o Flammable or Explosive Atmospheres: Flammable gases (methane, ethane, etc.), vapours, dust that could be ignited by an uncontrolled ignition source. This risk increases if an oxygen-enriched atmosphere (23% by volume) is present.
  - o Vapours, Mists, or Dusts.
- Harmful energy sources requiring isolation and lockout to ensure they remain in a zero-energy state.
  - Uncontrolled introduction of water, liquids, steam, or gases (improper control of water, steam, or pressurized gases introduced during cleaning or surface preparation work).
  - Contact with moving parts (being trapped or crushed by moving parts not properly isolated/locked out).
  - Crushing/Engulfment or entrapment (risk of becoming trapped or buried by internal components or bulk materials).
  - Entry and exit to the confined space sufficient for emergency egress and size adequate to allow personnel wearing respiratory equipment, if required by conditions.
  - Other hazards resulting from work or equipment being used, such as:
    - o Electrical hazards (including static),
    - o Excessive temperatures - heat or cold,
    - o Noise,
    - o Falls/slips,
    - o Radiation,
    - o Direct contact with corrosives,
    - o Iron sulphide (pyrophoric material), or
    - o Biological substances (e.g., bird or rodent droppings) or stinging/biting insects and snakes.
  - Tools required to be used in the work.



If a hazardous condition develops in a space during the entry, the work activity will be suspended, and the confined space hazard assessment will need to be reviewed and updated as applicable before work resumes in the confined space.

The confined space hazard assessment review shall evaluate the effectiveness of hazard assessment process regarding the confined space and the suitability of established controls. The review of controls shall be based on relevant factors, such as:

- changes in workplace conditions or work activities
- workplace inspection reports
- injury statistics
- event analyses
- the applicable SDS of any hazardous products that were contained in the Confined Space or that could be released.

### **6.3 CONTROL OF HAZARDS**

Risks associated with a confined space may be reduced by:

- Elimination:
  - Eliminate the confined space by eliminating the need to enter the space
  - Eliminate the confined space by modifying the configuration of the space.
- Substitution:
  - Utilizing tools in lieu of a traditional entry
  - Confined space work is contracted to a qualified contractor to perform
- Engineering Controls:
  - Ventilation to maintain the oxygen level between 19.5% and 23%
  - Ventilation to ensure clean breathable air is continuously blown into the space
  - Isolation to remove or separate equipment from all energy sources and appropriate control the energy through lockout
  - Eliminate the confined space by modifying the configuration of the space
  - Providing pedestrian, vehicle, or other barriers as necessary to protect entrants from external hazards
- Administrative Controls
  - Procedures for continuous atmospheric monitoring
  - Permits and planning for confined space entry and rescue
  - Procedures and guidelines for confined space entry

- Personal Protective Equipment (PPE)
  - Personnel may be required to wear an appropriate level of respiratory protection, full body harness, lifeline, and other PPE as necessary that is identified in the hazard assessment and as per company policy. A harness and lifeline should be worn to facilitate non-entry rescue at all times unless the retrieval equipment would increase the overall risk of entry or would not contribute to the rescue of the entrant. Guidance on proper selection of PPE is covered in Personal Protective Equipment, Fall Protection and Respiratory Protection Standards.

## **6.4 TYPES AND CLASSIFICATIONS OF CONFINED SPACES**

Confined spaces are at most locations. Spaces that typically meet the definition of confined spaces on the company's property include, but are not limited to:

- Tanks
- Vaults
- Culverts
- Pits
- Some parts of machinery
- Ventilation systems
- Access openings (manholes)
- Pipes
- Towers (heaters)
- Railway tank cars

All Confined Spaces shall be designated as High Hazard Atmosphere – IDLH Atmosphere until results of initial Atmospheric Monitoring are determined. Based on the results, a space may then be newly designated as Low Hazard/ Restricted Space, Moderate Hazard Atmosphere – Non-IDLH, or High Hazard Atmosphere – IDLH Atmosphere. Both Moderate Hazard Atmospheres and High Hazard Atmospheres meet the requirement of a “hazardous confined space”, as per the Canada Occupational Health and Safety Regulations (COHSR).

When determining if a space is a confined space, see Appendix 12.1 Identification of a Confined Space for additional guidance.

### **6.4.1 LOW HAZARD ATMOSPHERE (RESTRICTED SPACE)**

A low hazard atmosphere (restricted space) is one where a hazardous atmosphere is not likely to exist. A low hazard atmosphere (restricted space) is where the actual and potential for the following to exist is unlikely while workers are in the confined space for the duration of the work activity:

- The development of a hazardous gas, vapour, dust or fumes in normal conditions or
- Unsafe oxygen content less than 19.5% or more than 23% by volume.

Typically, the risks are more associated with the physical configuration of the space, access/egress, etc. Under normal conditions, it is anticipated that this atmosphere is not likely to change during the work activity.

Note: if ventilation is required to maintain a low hazard atmosphere, the space is considered Moderate Hazard (Non-IDLH) Atmosphere at a minimum

The basis for determining that all Hazards in the space have been eliminated is documented on:

- Parts 1 - 6 of the Confined Space Entry Permit; and
- Hazard Assessment.

If a Hazard arises or occurs within a low hazard atmosphere (restricted space), each worker in the space shall exit the space. The space shall then be reassessed to determine if it shall be re-designated as a Moderate Hazard (Non-IDLH) Atmosphere or High Hazard (IDLH) atmosphere Confined Space.

### **6.4.2 MODERATE HAZARD (NON-IDLH) ATMOSPHERE**

A moderate-hazard (Non-IDLH) atmosphere is one where there is the potential for a hazardous atmosphere to exist i.e., a Confined Space which has been purged and ventilated and steps have been taken to provide and maintain a safe atmosphere and there has existed or was likely to have existed:

- A hazardous gas, vapour, dust or fumes; or
- Unsafe oxygen content less than 19.5% or more than 23% by volume could develop if circumstances change.

These types of spaces have been known to have potentially hazardous atmospheres either before or during the work. An example could be a vessel containing a product. After isolation, cleaning, purging, ventilation, the fact it had something hazardous in there to begin with leads to a potential that an atmosphere could exist if something were done incorrectly or if other equipment fails (e.g., ventilation fan). Hence, a Moderate-Hazard (Non-IDLH) Atmosphere confined space.

If an IDLH atmosphere is encountered during a Moderate Hazard (Non-IDLH) atmosphere entry, workers must vacate the space and additional controls should be implemented to mitigate the hazard and lower the levels below IDLH. If this cannot be achieved, then the Director's (or designate's) approval is required to proceed with a High Hazard Atmosphere entry.

### **6.4.3 HIGH HAZARD (IDLH) ATMOSPHERE**

A high hazard (IDLH) atmosphere is one where a hazardous atmosphere does exist i.e., a Confined Space which cannot be ventilated to provide and maintain a safe atmosphere, and in which there now exists or is likely to exist:

- A hazardous gas, vapour, dust or fumes; or
- An oxygen content of less than 19.5% or more than 23%.

This is a type of space that, due to the unique circumstances of the particular space, the atmosphere cannot be purged and/or ventilated adequately to provide a safe breathable atmosphere. It could also be a situation where the atmosphere may be completely unknown or the space be compromised by the ambient working environment. Therefore, it is considered to be a High Hazard Atmosphere confined space.

Planned work should not take place in IDLH environments. If an IDLH environment exists, or has potential to exist, then work shall stop until controls are in place to eliminate, control or minimize the hazards to an acceptable level. Entry into a confined space that has been classified as a High hazard (IDLH) Atmosphere – IDLH requires Director or designate approval of confined space entry plan, procedures and Hazard Assessment, refer to the Immediately Dangerous to Life and Health Atmospheres procedure for process for working in an IDLH atmosphere.

### **6.4.4 TEMPORARY RECLASSIFIED SPACE**

A temporary reclassified confined space is one that started as a confined space, but through control of all actual or potential hazards no longer meets the definition of a confined space (e.g., no longer has limited means for entry and exit, etc.). An example of this would include a tank that has been degassed, cleaned, and has a door sheet removed. In this situation, the workers will still need to consider all applicable safety standards, e.g., Atmospheric Monitoring, PPE, Respiratory Protection, etc.

### 6.4.5 CONFINED SPACE REQUIREMENTS

Requirements		Confined Space Hazard Classification		
		Low Hazard Atmosphere (Restricted Space)	Moderate Hazard (Non-IDLH) atmosphere	High Hazard (IDLH) atmosphere
Eng.	Isolation & LOTO	Determined by the hazard assessment		
	Ventilation	Determined by the hazard assessment		Yes, safeguards if ventilation fails
Admin.	Is a confined space permit required?	Required – Parts 1 - 6	Required – All Parts	
	Safe Work Permit	Per the requirements of the Safe Work Permit & Work Authorization Standard		
	Hazard Assessment	Required		
	Confined Space Entry Plan			
	Pre-Entry Meeting			
	Director (or Designate) Approval	Not Required		Required
	Rescue Team Requirements	Determined by hazard assessment	Onsite and prepared to respond	Outside the confined space and available to provide immediate response
	Rescue Plan	Required		
	Location and Attention of Confined Space Attendant	Must be able to fulfill duties below	Must be stationed near space entrance	Must be stationed near space entrance exclusively and continuously attend to Confined Space Attendant duties
	Rescue and first aid requirements for Confined Space Attendant	Able to immediately summon rescue personnel		Equipped and capable of performing rescue / fulfilling rescue duties
	Confined Space Attendant check on wellbeing of Worker(s)	Every 20 minutes	Minimum of every 20 minutes; more often based on hazards of space or task performed	Continuous
	Additional Duties of Confined Space Attendant	N/A		Prevent entanglement of lifelines and airlines
	Entrant contact with Confined Space Attendant	A way for Entrant to summon Confined Space Attendant at any time	A way for Entrant to summon Confined Space Attendant at any time, including from inside the space	
PPE	Air Monitoring	Initially to classify atmospheric conditions	As Required in the Atmospheric Standard Required	
	Mandatory Equipment (Hot Work & Insulated Equipment)	Determined by hazard assessment	The use of non-spark or intrinsically safe electronic equipment in potentially flammable or explosive environments as defined by the Canadian Electrical Code	
	PPE	As required in the PPE, Respiratory Protection Standards		

**Note:** Temporary Reclassified Spaces: The space no longer meets the criteria of a confined space and must be in compliance with the requirements of the Safe Work Permit.

---

## 6.5 TRENCHES AND EXCAVATIONS

A trench or excavation is not considered a confined space unless otherwise determined through hazard assessment due to:

- Impeded access/egress as a result of the depth of excavation or complexity of piping within the excavation, and
- Contains or has the potential to contain a hazardous atmosphere.
- These exceptions need to be determined in advance and discussed during work planning.

Although the excavation itself may not be a confined space, a confined space may exist within an excavation, e.g. entry into a pipe. The hazard assessment will need to include any activity that has the potential to produce a hazardous atmosphere.

## 6.6 CONFINED SPACE ENTRY PLAN

Before an employee is permitted to enter a confined space, the work group that is responsible for or conducts confined space operations must prepare and implement a written confined space entry plan (as part of a *Confined Space Package*). For more on *Confined Space Package* refer to section 6.12. A confined space entry plan [a template that can be found in the Governance Document Library (GDL)] at a minimum shall include:

- Applicable or assigned confined space procedures/hazard assessment/job plans.
- Information on the confined space, e.g., dimensions, lockout and isolation locations.
- Confined Space Permit, (template can be found in the GDL):
  - Identification of work activity;
  - Verification of lockout and isolation, if applicable, (Energy Isolation, Lock Removal and forms available via the GDL);
  - Ventilation calculations e.g., to dilute airborne contaminants or control for hazardous atmospheres, if deemed applicable from the hazard assessment.
- Coordination of work activities/practices, Emergency Response and Rescue:
  - Communication process e.g., constant communication with authorized entrants, emergency warning system;
  - Identify roles and responsibilities;
  - Required PPE, including the use of lifelines;
  - Emergency Response & Rescue Plan;

- Rescue & First Aid equipment.
- Lockout and isolation, coordination of work activities.

For more on confined space permits, permit roles and Rescue, refer to section 6.8 Confined Space Permit, 6.9 Work Practices, and 6.10 Confined Space Rescue.

## **6.7 PRE-ENTRY MEETING**

The Entry Supervisor will conduct a Pre-Entry meeting prior to entry with all involved workers including:

- Worker(s) entering space
- Confined space attendant personnel
- Rescue personnel, at a minimum when working in a High Hazard IDLH atmospheres
- Site or Worker Supervisor(s) that may direct the work of any of the above

The Pre-Entry Meeting will cover the following before confined space entry as applicable:

- The confined space entry permit requirements
- Established procedures
- Atmospheric testing procedures
- Method of recording testing results
- Communication system
- Isolation of energy sources and control of materials movement
- Required PPE/respiratory protection equipment
- Securing the confined space from unauthorized entry
- Emergency equipment and required inspection of the equipment
- Ventilation requirements

In the event personnel are added to the Entry Team that did not attend the pre-entry meeting, the Entry Supervisor must review the contents of the meeting with the additional personnel and be satisfied they are fully briefed on their role and responsibilities in the entry activities.

The Entry Team should engage in cursory review of the contents of the Confined Space Package, with a primary focus on:

- Ensuring the stipulations set out in the Confined Space Hazard Assessment have been or will be met prior to entry, including:

- Pre-initial entry preparations such as isolation, lock out / tag out, and any cleaning, purging, or ventilation activities.
- Controls to be applied during entry or work within the space.
- Ensuring familiarity with the procedure for initial and any subsequent entry under review.
- Review of the Rescue Plan and ensuring all members are clear on their roles.

All stipulated pre-entry preparation activities must be complete and verified prior to entry.

For subsequent entries to conduct tasks within confined spaces, the size, scope, and necessity of an Entry Team meeting needs to be based on:

- The level of hazards within the space and introduced by the tasks to be conducted.
- The existing familiarity of entrants, confined space attendant, rescue, Entry Supervisor with the confined space and its hazards (e.g., are the same personnel involved as those attending the pre-entry meeting?).
- At minimum, prior to any entry to complete a task, the Entry Supervisor must go over the Confined Space Hazard Assessment for the task at hand with the Entrants as part of the Safe Work Permit process (in lieu of a full Entry Team meeting).

## **6.8 CONFINED SPACE ENTRY PERMIT**

A worker shall not enter a confined space without a valid confined space entry permit. Any site emergency, or if the criteria for entry to be terminated is met, shall force the stoppage of all work and will require a new permit to be authorized. The following requirements apply to the confined space entry permit:

- The permit is issued and authorized by permit issuer
- The permit is received by a qualified worker who is involved in the confined space entry
- The permit is approved by a qualified Enbridge employee or representative when a contractor is performing entry
- The permit must be signed by the permit issuer, receiver and approver if applicable
- The permit cannot be issued until all required fields are completed, and all hazards have been identified and controlled
- If there are changes in the field, the permit will be revised and discussed with impacted workers. If there is a change to the scope of work, a new permit is required.
- Permits are valid for 12 hours or until the end of the shift unless there is an approved extension. A permit may be extended if:



- Authorized entrants involved in the work remain the same
  - The extension is identified and authorized on the permit by the permit issuer
  - When an extension is required, both copies of the permit need to be authorized by the permit issuer
  - A review of the permit confirms it is still valid
- The permit must identify conditions to terminate entry.

The permit will be maintained / posted outside of the confined space with the supporting documents.

A single permit may be utilized for multiple spaces when the hazards of the space and the work to be performed are similar.

In the event that an entry has been terminated, this includes the permit being terminated, no entry will occur until the hazard assessment can be updated and the space is deemed safe for entry.

### **6.8.1 CONFINED SPACE PERMIT ROLES**

Confined Space Permit Issuer shall:

- Determine Confined Space Classification
- Review Hazards and controls with the Permit Receiver
- Verify that appropriate controls are in place
- Ensure Initial Atmospheric Monitoring is complete
- Ensure all confined space entry and regulatory requirements are met prior to issuing the confined space entry permit
- Terminate the confined space entry and permit if conditions warrant termination.

Note: this role can be filled by an Enbridge employee or representative.

Confined Space Entry Permit Approver shall:

- Acknowledge the work
- Review Hazards and controls with the Permit Issuer
- Ensure the Confined Space Entry Permit Issuer is aware of site-specific information.

Note: this role is intended for approval of contractor entries and is not required for employee entries. This role can only be filled by a qualified Enbridge employee or representative.

Confined Space Entry Permit Receiver shall:

- Attend and participate in the confined space Pre-Entry Meeting

- Review Hazards and controls with the Permit Issuer
- Provide the Permit Issuer with adequate notice of intended entry to review scope, hazards and confined space documentation.
- Provide a sufficient description of the scope of work
- Review hazards and controls with Workers involved in the work
- Ensure requirements on the permit are followed.

Note: this role can be either an Enbridge employee or contractor who is involved with the entry to be performed.

### **6.8.2 TERMINATING AN ENTRY**

If atmospheric monitoring indicates that unplanned or unexplained changes have occurred in the confined space, all work shall stop and workers will evacuate the confined space. The hazard assessment and permit shall be reviewed if an entry has been terminated and updated as required.

The Entry Supervisor will document on the confined space permit atmospheric conditions of when a confined space entry will be terminated.

If the acceptable criteria cannot be maintained, the typical conditions to terminate an entry may include:

- Oxygen levels that are below 19.5%, or above 23%
- LEL of greater than 10% when conducting hot work
- LEL of greater than 20%
- When any contaminant is above the action level per legislative requirements
- Any injury
- Any abnormal operation
- Change to the scope of work
- Site emergency
- If requested to stop work.

The time of termination shall be documented on the Confined Space Permit, as the case may be, by the Receiver. Suspended permits shall be revalidated, at a minimum, verbally by the Issuer and documented on the Confined Space Permit before work can resume.

---

Note: Suspensions due to scope of work changes cannot be revalidated. A new Confined Space Permit is required.

### **6.8.3 PERMIT DOCUMENT COPIES**

White/top copy: Permit Receiver keeps or posts this copy at the work location while the permit is valid. Permit Receiver returns this copy, and other pertinent documentation to the Permit Issuer when the Permit time period has expired.

If an event occurs during the course of work, the white copy of the Permit along with all other documentation shall be forwarded to the person responsible for conducting the event analysis and will be retained as identified in the requirements for event analysis documentation.

Yellow copy: Permit Issuer maintains this copy to identify work activities occurring at the site. Discard after the white copy is returned.

In compliance with Enbridge's Records Management Policy and Records Retention Schedule, Enbridge Employees must retain all Permits and any related documents or records. All required documentation applicable to Confined Space entry is developed, completed and maintained, in accordance with Enbridge requirements and Applicable Legislation.

Contractors shall have a records retention policy to ensure that all documents or records used, prepared or produced by the contractor in the performance of the work are maintained by the contractor for durations of time that are not less than the limitation periods prescribed in the applicable statutes of limitations or limitation of actions legislation in force in the jurisdictions the contractor operates.

## **6.9 WORK PRACTICES**

### **6.9.1 PREVENTING UNAUTHORIZED ENTRY**

All Confined Spaces in the Confined Space Inventory must either be:

- Secured against entry (e.g., bolted shut or locked), or
- Identified by a sign that states "Danger, Confined Space, Entry by Permit Only" or a sign that uses similar wording at the entry point to indicate that this is a Confined Space and that entry is not permitted without a permit.
- When there is a confined space attendant present at an open confined space, the attendant must ensure all entrants are authorized for entry into the confined space.

Signage that has been removed to allow entry into the confined space shall be replaced when the space has been left unoccupied, this includes breaks and shift change.

## **6.9.2 ATMOSPHERIC TESTING/MONITORING**

Refer to the Atmospheric Monitoring and Respiratory Protection Standards for additional information on confined space atmospheric monitoring and sampling.

Atmospheric monitoring for hazards shall:

- Be conducted by a qualified worker using calibrated test instruments that are appropriate for the atmosphere being tested and used in accordance with manufacturer's specifications
- Be completed in accordance with the requirements identified on the hazard assessment
- Be performed in a manner that does not endanger the health or safety of the worker performing the test
- Be performed in the following order:
  1. Oxygen content (% O<sub>2</sub>)
  2. Flammable gases/vapors (% LEL)
  3. Toxic air contaminants (e.g., H<sub>2</sub>S)
  4. Other toxic contaminants associated with the work environment, work activity and related job tasks (e.g., CO, Benzene).

### Initial Atmospheric Monitoring

Initial atmospheric monitoring is required prior to entry into any confined space, and before a worker re-enters a confined space that has been unoccupied for any length of time. Initial testing must be performed no more than 20 minutes prior to an entry. Atmospheric testing must be repeated within 20 minutes of entry if a confined space is vacated for more than 20 minutes.

Initial monitoring should be completed from outside the space utilizing remote gas detector accessories and equipment such as sample draw pumps and wands whenever possible. Initial atmospheric testing from outside the confined space is not considered entry and does not require a permit. If testing is being completed by a contractor, a safe work permit would be required prior to the completion of the task.

If initial atmospheric monitoring cannot be completed from outside the confined space, conduct initial testing under the respiratory protection level based on the conditions at the time. If this cannot be determined or adequately assessed, wear SCBA / SABA respiratory protection.

If the levels at the entrance are not IDLH, then entrants can proceed further into the space under air, without Director (or designate) approval until an IDLH atmosphere is encountered. If an IDLH atmosphere is encountered during initial monitoring, the entrants must vacate the space and treat as a High Hazard (IDLH) atmosphere, requiring Director's (or designate's) approval for entry.

Enbridge treats all spaces as High Hazard (IDLH) atmospheres prior to initial entry; however, Director (or designate) approval is not required to perform initial atmospheric monitoring of the space until a hazardous (IDLH) atmosphere is confirmed.

Complete atmospheric monitoring at various locations and elevations of the space whenever possible. Refer to the Atmospheric Testing Standard and the manufacturer's recommendations when performing atmospheric monitoring. Also, consider the response times, length of hose, attachments, functionality of monitor etc.

### Continuous/Periodic Monitoring

For confined spaces deemed to have a moderate or severe hazard atmosphere, continuous monitoring of gases that present an ongoing risk to entrants is required. Continuous atmospheric monitoring for the following is required anytime a worker is in a confined space:

- Oxygen (% O<sub>2</sub>)
- Lower explosive limit (% LEL)
- Hydrogen sulfide (H<sub>2</sub>S)
- Carbon monoxide (CO)

Levels are documented on the confined space entry permit at a frequency determined by the Entry Supervisor.

Periodic atmospheric monitoring and atmospheric sampling may be required for other hazards or contaminants (e.g. benzene). These frequencies shall be determined by the Entry Supervisor and documented on the confined space entry permit. Frequency for testing may vary from minutes to hours, depending on the hazards of the space.

The use of a Personal Monitor when working in a confined space should be in accordance with the requirements of the Atmospheric Monitoring Standard.

### **6.9.3 INERTING**

A confined space may be inerted if it is not reasonably practicable to eliminate an explosive or flammable atmosphere through other means. Inerted confined spaces will be treated as High Hazard (IDLH) Atmosphere due to the removal of oxygen. If a confined space is inerted, ensure that:

- Every worker entering the confined space is equipped with SCBA / SABA respiratory protection equipment until oxygen levels have returned to normal.
- All ignition sources are controlled
- The atmosphere within the confined space stays inerted while workers are inside.

Note: notification to regulatory bodies may be required when placing workers in an inert atmosphere per local legislative requirements

#### **6.9.4 VENTILATION REQUIREMENTS**

If atmospheric hazards exist or are likely to exist in a confined space, the confined space shall be purged or ventilated, or both, before any worker enters the space. Acceptable atmospheric levels, as identified on the confined space entry permit, shall be maintained at all times when worker(s) are present in a confined space.

Ventilation requirements shall be determined prior to the entry of the confined space, or utilized if levels are not acceptable. If testing indicates that the confined space's atmosphere is explosive, or if assessment determines that an explosive atmosphere is likely to develop, then purging of the space with an inert gas shall be performed prior to ventilation. Using air movers as a means of ventilation may create a hazardous, explosive atmosphere, due to the addition of oxygen into the confined space.

If ventilation and/or purging are not practical to maintain acceptable atmospheric levels in a confined space, the workers involved shall wear respiratory protection equipment in accordance with the Respiratory Protection Standard.

If mechanical ventilation is required to maintain a safe atmosphere in a confined space, the ventilation equipment shall be equipped with an alarm that will be activated automatically if the equipment fails. An adequate warning system of ventilation failure shall be in place, to ensure each worker receives each warning and is able to exit the confined space safely.

The mechanical ventilation equipment shall be audible or visible to every worker in the confined space, or monitored by a worker who is in constant attendance at the equipment and who is in communication with the authorized entrants. Should the ventilation equipment fail to operate properly, this worker shall immediately direct the authorized entrants to evacuate.

Air volume for confined spaces shall meet the following criteria, if applicable:

- Minimum volume of 1.9 m<sup>3</sup>/s of air passes through the active working area; or
- Air in the confined space contains at least 19.5% oxygen by volume, LEL is below 10%, and the concentration of each hazardous substance or contaminant(s) present in the space's atmosphere is below acceptable criteria outlined in the permit (below all exposure limits in most cases); or
- The confined space has an air exchange rate of at least 8 times/hour; or
- Per a consensus standard accepted by industry (e.g., API, ANSI, CEPA)

Proper set-up of a ventilation system for a confined space is critical to ensure its effectiveness and to minimize/control hazards and exposures. Consider the following:

- Eliminate “short-circuiting” of airflow around the fans or blowers by using an adaptor plate to bolt the fan to the flange of a manway, or use any other safely feasible measure.
- Supply air needs to be ducted/hosed to deliver it to the work zone and exhaust air needs to be able to capture any contaminants that may be generated by work activities. The exhaust hood or duct should be placed 300 mm (1 ft.) from the source of the contaminant(s).
- A combination of pushing air in and pulling air out of the confined space is often the most effective. If a contaminant is heavier than air (e.g., crude oil vapors), the ventilation strategy should be to push air in from the top and channel exhaust air out from the bottom. However, if the contaminant is lighter than air (e.g., methane), the contaminant has a tendency to rise to the top of the space; thus, the ventilation strategy should be to push air in from the bottom and pull air out from the top.
- Ventilation should be continuous, where possible, if the source(s) of the hazardous atmosphere still exists, or if operations in the confined space generate contaminants or hazards that create a hazardous atmosphere.
- When a confined space has only a single manway or opening or has interior obstructions that decrease the effectiveness of dilution ventilation, local exhaust ventilation with a capture hood/duct placed at the source of contaminants is recommended.
- Confined spaces containing flammable gases or vapors may need to be purged with an inert gas prior to ventilating with air. If inert gases (e.g., nitrogen, argon, carbon dioxide) are used for inerting the confined space, the space shall be well-ventilated after the inerting is completed. Then the atmosphere shall be re-tested before any authorized entrant enters the space.
- Where flammable or combustible gases may be present, the ventilation equipment used shall be designed for use in such environments. The equipment shall also be properly grounded and bonded to prevent static electricity from potentially igniting a combustible source.
- Ensure venting activities do not create another hazard. For example, scrubbers may be applied to the venting exhaust to prevent buildup of contaminant in another location.
- If the location has an air permit, the release of emissions must not violate air permitting requirements. Refer to the Environment Department for further clarification.
- Ensure the make-up (fresh) air for the confined space is free of contaminants. Note that make-up air could be contaminated by:

- Exhaust air that carries contaminants from work that is carried out within the confined space
- Exhaust from nearby or adjacent fuel-operated equipment, such as generators, air compressors, vacuum trucks, or other vehicles
- Vapors or substances arising from nearby or adjacent operations and processes, e.g., organic vapors from painting, silica from blasting operations, or lead from paint removal work.

### **6.9.5 HOT WORK**

Unless a qualified worker has determined that work can be performed safely, hot work shall not be performed in a confined space that contains:

- an explosive or flammable hazardous substance in a concentration in excess of 10% of its lower explosive limit; or
- oxygen in a concentration in excess of 23%.

If these conditions are exceeded during hot work activities, the hot work shall stop and remain stopped until the conditions are deemed safe for work to continue. This determination shall be based on additional or subsequent air testing.

When performing hot work activities, a qualified fire watch person shall patrol the area surrounding the confined space until all fire hazards have passed per the Hot Work and Ignition Sources Standard. Appropriately rated fire extinguishers are required in the immediate area per the Emergency Preparedness Standard.

### **6.9.6 ISOLATION REQUIREMENTS**

Refer to the Control of Hazardous Energy Standard for additional information on isolation and control of energy. Each worker entering a confined space shall be adequately protected against isolation related hazards, as follows:

- Protect workers from the release of hazardous substances in the confined space by disconnecting, blanking, blinding or double block and bleed of piping, cribbing etc.
- Protect workers from contact with electrical energy inside the confined space by disconnecting, de-energizing, lockout and tagging the source of electrical energy.
- Protect workers from moving parts of equipment inside the confined space by disconnecting the equipment from its power source, de-energizing the equipment, ensuring there is no stored energy, locking and tagging all energy sources.
- Other adequate means of worker protection and hazard prevention are required if the above controls are not possible.



---

### **6.9.7 TOP-ENTRY CONFINED SPACES**

If entrance into a confined space is from the top, the following requirements shall be met:

- each worker entering the space shall use an appropriate full-body harness and, where appropriate, be attached to a lifeline per the Fall Protection Standard.
- if a lifeline is used, the lifeline shall be attended by another Worker who is qualified to carry out the established rescue procedures.
- a mechanical lifting device for rescue shall be located at the entry to the confined space and available for use during a rescue; the device shall be placed at the entrance at all times when one or more workers are in the confined space.
- If the use of a full-body harness or lifeline could create an additional hazard, an alternate method of rescue shall be developed and implemented.

### **6.10 CONFINED SPACE RESCUE**

Each confined space rescue requirements will vary based on the classification of the space and any unique hazards identified. Every confined space entry requires:

- The services of one or more rescue personnel, based on the documented Rescue Plan included with the Confined Space Entry Plan or package.
- Personnel assigned rescue duties must be notified before workers enter a confined space and when all workers have exited from the space.
- If multiple confined spaces are being entered, notifying rescue personnel to be onsite in an alert status is sufficient, unless the confined space(s) are High Hazard (IDLH) Atmosphere
- In cases where there is a contract for primary rescue personnel to provide 24-hour service, individual notification may not be required.
- Assigned rescue personnel must monitor any signaling system used to summon them while a confined space entry is underway or while on an alert status.
- Where an entry-rescue into a High Hazard (IDLH) atmosphere is a possible rescue scenario, the rescue team must remain at the confined space during the entry itself. The rescue team must have PPE donned, including SCBA or SABA with an escape bottle, and respirator masks at the ready.
- A rescue worker may not enter the confined space unless there is at least one additional worker located outside to render assistance.
- The confined space attendant may assist a rescue worker and may perform a non-entry rescue using an attached lifeline.

- In the event of rescuing an entrant involves physically entering the confined space, a rescue worker in addition to an existing confined space attendant will be required to execute a rescue (i.e., rescuer enters to extract the entrant, the attendant remains outside to render assistance).
- Once rescue is initiated, the People Leader on the scene is either (a) an Entry Supervisor with knowledge of the rescue procedure or (b) a qualified rescue worker.
- The most senior person present, not directly involved in the rescue shall trigger the site-specific Emergency Response Plan.
- The qualified confined space rescue team retains control over the rescue itself until the entrant is extracted.
- Rescue personnel must wear SCBA or SABA with an escape bottle in any rescue within a confined space with an unknown or IDLH atmosphere.
- Workers entering a space assessed as a High Hazard (IDLH) Atmosphere must wear a safety harness securely attached to a lifeline.
- The lifeline must be securely anchored outside the confined space.
- The confined space attendant is responsible to assist in ensuring the lifeline does not become entangled during entry and work inside.
- The confined space attendant must be able to extract the worker(s) without entering the space using the lifeline in an emergency and must be supplied with a mechanical device suitable and designed for confined space entry rescue, as required, to facilitate this type of rescue.
- This requirement does not apply if the lifeline itself creates a hazard or extraction with the lifeline would be impossible due to the configuration of the space.

Note: These lifeline requirements may also apply in Low Hazard (Restricted Space) or Moderate Hazard (Non-IDLH) Atmosphere spaces that have physical hazards (e.g., working at heights, engulfment, entrapment) that may be effectively controlled with a lifeline.

### **6.10.1 RESCUE PLAN**

Confined spaces must have a formal rescue plan developed prior to space entry and maintained with other confined space entry documents. This plan is to be read and reviewed prior to initial entry by the Entry Team to:

- Ensure familiarity with the plan for all participants (entrants, confined space attendant, and rescue team) with the plan.

- Determine if any additional rescue provisions need to be prepared.

Note: A single rescue plan may be applicable to several confined spaces that share similar characteristics and hazards.

The Rescue Plan must include at a minimum:

- Information on the confined space
- Completed Hazard Assessment
- Site Layout
- Equipment necessary to complete a rescue
- Methodology of rescue
- Names of individuals that will be onsite performing the rescue
- Communication methodology
- Medical equipment necessary to be onsite
- PPE requirements

The Confined Space Rescue Plan (for moderate or high-risk atmospheres) shall be retained onsite, as per Enbridge Record Retention Schedule.

Frequency and requirements to complete drills as outlined by Regulatory Requirements for that jurisdiction.

### **6.10.2 RESCUE EQUIPMENT**

The selection of equipment must be appropriate for the confined space. All rescue equipment must be appropriately rated for its use. Equipment must have inspections documented and available for review.

### **6.11 CONFINED SPACE CLOSURE REQUIREMENTS**

Once work is completed within a confined space, prior to final closure of the space, the following should be done:

- Final visual inspections to ensure no personnel or equipment are inside the space prior to closure.
- Ensure any active Permit is formally closed with required sign-offs complete.

---

## **6.12 CONFINED SPACE PACKAGE**

When a contractor will be conducting confined space entries, this package will be provided to them from an Enbridge representative all relevant documentation will be compiled and available prior to entry into a confined space. This Confined Space Package should include (as applicable):

- Worksite specific Confined Space Entry requirements
- Any specific identified Hazards as well as experience with the space, such as knowledge of hazardous conditions
- Applicable SDS
- Confined Space Permit
- Hazard Assessment
- Piping and Instrumentation Diagrams (P&IDs)
- Isolation drawings (identify isolation points, line breaks and blind locations)
- LOTO form(s)
- Procedures for tasks to be conducted in Confined Space (e.g., Operations & Maintenance Manuals (OMMs))

## **6.13 EXTERNAL FLOATING TANK ROOFS**

Entries onto tank roofs may change in classification depending on the hazards. There are work task activities that do not pose the hazard of actual or potential hazardous atmospheres when appropriate controls are in place. Examples of this would include work on the tops of open floating roofs of tanks that do not include exposure to fresh or new product and does not have the potential to change the atmosphere due to the work activity (e.g., removing the plug from a roof drain, visual inspection of components, cold work, etc.). Tasks that allow exposure to product or cause changes to atmosphere must be treated as a moderate or high hazard atmosphere confined spaces (e.g., pulling back the secondary seal, opening a vacuum breaker, etc.).

When performing a tank roof entry, employees should still consider other hazards such as slippery walking surfaces, ice and wind when planning work.

Controls for actual or potential atmosphere may be controlled through items that include, but are not limited to:

- Tank roof is static. The product and atmospheric conditions (e.g., wind, temperature, etc.) of the tank will need to be considered to determine if the atmospheric conditions have stabilized and the tank is safe for entry. The tank atmosphere will be confirmed with a monitor with appropriate PPE.

- The Control Center Operations (CCO) is contacted
- Tank is isolated
- Tank does not have any known seal leaks
- Tank does not have any open vacuum breakers
- Tank roof does not have any new visible product on it
- Tank is at a high enough level to have natural ventilation (e.g., no vertical ladders).

In the event a tank roof entry does not have an actual or potential hazardous atmosphere, and the work activity being performed will not change the classification, the space may meet the definition of a low hazard atmosphere confined space. Mechanical ventilation would not be required for this work activity if data shows there is not a hazardous atmosphere and the potential has been removed through appropriate controls. Personnel must not enter under a floating roof unless it is secured by anti-rotational devices and by supplemental support in the area that will be occupied. Exceptions must be approved by Regional Management.

Note: Walking on Aluminum geodesic dome roofs is strictly prohibited.

## **7.0 TRAINING**

Personnel working in the field must be knowledgeable in this Standard and may be assigned applicable training as driven by the Health & Safety Training Matrices. Reference the Health & Safety Training Catalogue and matrices on the GDL for further information and training re-certification requirements.

### **7.1 AUTHORIZED ENTRANT**

Entrants (employees and contractors) entering a confined space considered hazardous will at a minimum require, third-party (monitor and entry) Confined Space Entrant Training (e.g., employees require SR: Confined Space Entry Hands On-ILT).

### **7.2 ATTENDANT/SAFETY WATCH**

Confined space attendants or Safety watches require the same training as Authorized Entrants, as well as First Aid (Standard Level) Training.

### **7.1 RESCUE PERSONNEL**

Rescuers require third-party rescuer training (e.g., employees require SR: Confined Space Rescue –ILT), annual Rescuer refresher training to the emergency (rescue) procedure, and First Aid (Standard Level) training.

---

## **8.0 RELATED DOCUMENTS**

Atmospheric Monitoring Standard  
Emergency Preparedness – Personal Safety Standard  
Fall Protection Standard  
Hazard Assessment & Elimination Standard  
Hot Work & Ignition Sources Standard  
Immediately Dangerous to Life and Health Atmospheres Procedure  
Personal Protective Equipment Standard  
Respiratory Protection Standard  
Safe Work Permit & Work Authorization

## **9.0 RECORDS RETENTION**

Records identified in the Confined Space Standard are owned and managed by Regional Operations. The following records will be retained according to the Records & Information Management, Records Retention Schedule:

- Hazard Assessment,
- Confined Space Entry Permit (Yellow Copy of Permit Issuer),
- Rescue Plan,
- Confined Space Inventory.

Any of the above records shall be made available upon request to the regional Safety & Reliability personnel or by the work place committee.

## **10.0 STANDARD REVIEW**

A subject matter expert (SME) will perform a technical review of this standard annually to determine the accuracy of the content/information. The SME shall solicit input from applicable stakeholders to ensure the effectiveness of the standard. Any suggested changes must be reviewed and approved by the designated document owner.

## **11.0 REFERENCES**

Canadian Association of Petroleum Producers Code of Practice for Confined Space  
CSA Z1006-16 Management of work in confined spaces  
Alberta Occupational Health and Safety Code: Part 05 - Confined Spaces



---

Canadian Occupational Health and Safety Regulation: Part XI Confined Spaces

## 12.0 APPENDIX

### 12.1 IDENTIFICATION OF A CONFINED SPACE

#### Is This Space a “Confined Space”?

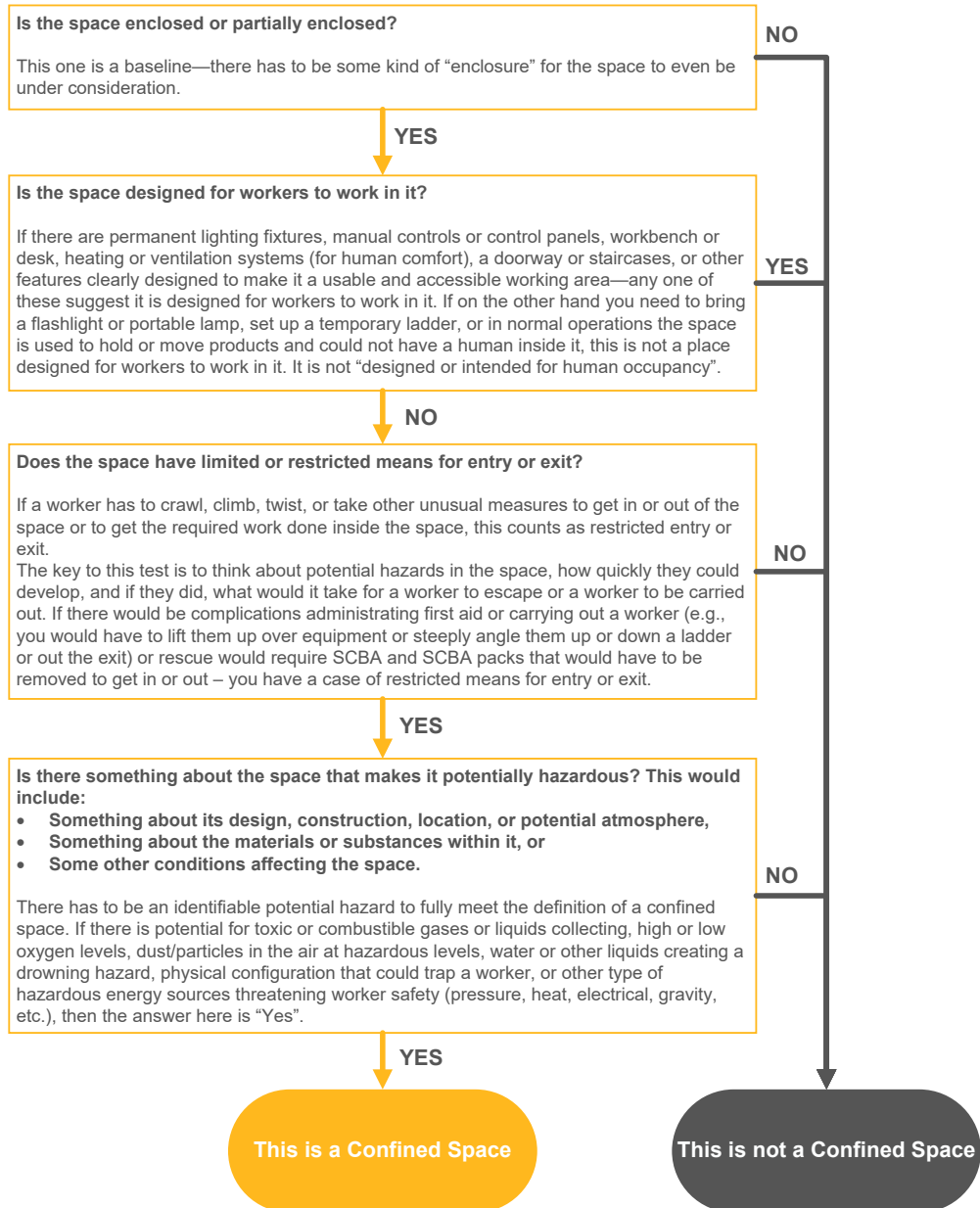





**12.2 CONFINED SPACE ENTRY PERMIT**

**000000 CONFINED SPACE ENTRY PERMIT - CANADA**

Part 1: Description	Date Permit Issued: _____ Contractor: _____ Site: _____ Time Permit Issued: _____ Time Permit Expires (12 hour max without extension): _____ Time Work Completed: _____ Emergency Response Contact Info (e.g. phone #, radio channel): _____ Location of Confined Space to be Entered: _____ SWP #: _____ Is there an Isolation LOTO Form: <input type="checkbox"/> Yes <input type="checkbox"/> No If yes, attach. Other: _____																				
Part 2: Confined Space Entry Checklist	<table border="1" style="width: 100%; border-collapse: collapse;"> <tr> <td style="width: 30%; padding: 2px;"> <b>Type of Work:</b>  <input type="checkbox"/> Cold  <input type="checkbox"/> Hot  <input type="checkbox"/> Electrical – line side of 480v/600v main breaker (clearance/isolation form required)                 </td> <td style="width: 30%; padding: 2px;"> <b>Work Environment:</b>  <input type="checkbox"/> Hazardous Area  <input type="checkbox"/> Restricted Area  <input type="checkbox"/> Unclassified                 </td> <td style="width: 40%; padding: 2px;"> <b>Confined Space Classification:</b>  <input type="checkbox"/> Low Hazard Atmosphere (Restricted Space) (Parts 1 – 6 of this permit is required)  <input type="checkbox"/> Moderate Hazard Atmosphere - Non-IDLH Atmosphere  <input type="checkbox"/> High Hazard Atmosphere – IDLH Atmosphere                 </td> </tr> </table> Description of Work: _____ _____ _____	<b>Type of Work:</b> <input type="checkbox"/> Cold <input type="checkbox"/> Hot <input type="checkbox"/> Electrical – line side of 480v/600v main breaker (clearance/isolation form required)	<b>Work Environment:</b> <input type="checkbox"/> Hazardous Area <input type="checkbox"/> Restricted Area <input type="checkbox"/> Unclassified	<b>Confined Space Classification:</b> <input type="checkbox"/> Low Hazard Atmosphere (Restricted Space) (Parts 1 – 6 of this permit is required) <input type="checkbox"/> Moderate Hazard Atmosphere - Non-IDLH Atmosphere <input type="checkbox"/> High Hazard Atmosphere – IDLH Atmosphere																	
<b>Type of Work:</b> <input type="checkbox"/> Cold <input type="checkbox"/> Hot <input type="checkbox"/> Electrical – line side of 480v/600v main breaker (clearance/isolation form required)	<b>Work Environment:</b> <input type="checkbox"/> Hazardous Area <input type="checkbox"/> Restricted Area <input type="checkbox"/> Unclassified	<b>Confined Space Classification:</b> <input type="checkbox"/> Low Hazard Atmosphere (Restricted Space) (Parts 1 – 6 of this permit is required) <input type="checkbox"/> Moderate Hazard Atmosphere - Non-IDLH Atmosphere <input type="checkbox"/> High Hazard Atmosphere – IDLH Atmosphere																			
Part 3: Air Testing Requirements	<table style="width: 100%;"> <tr> <td style="width: 50%; padding: 2px;"> <ul style="list-style-type: none"> <li>• Has the confined space location, hazards, and their controls, been reviewed and the confined space to be entered confirmed? <input type="checkbox"/> Yes <input type="checkbox"/> No</li> <li>• Has the hazard assessment been attached to the Permit? <input type="checkbox"/> Yes <input type="checkbox"/> No</li> <li>• Have all specific job responsibilities been assigned? (Indicate person responsible):                      Entry Supervisor – _____                      Equipment Lockout – _____                      Attendant – _____                      Atmospheric Testing – _____                      Preparation requirements completed prior to entry (cleaning, purging, venting, inerting, etc.): _____                      _____                      _____                      Conditions Under Which Entry is to be Terminated: _____                      _____                      _____                 </li> </ul> </td> <td style="width: 50%; padding: 2px;"> <ul style="list-style-type: none"> <li>• Have all entry points into the confined space been identified and properly secured against unauthorized entry? <input type="checkbox"/> Yes <input type="checkbox"/> No</li> <li>• Is required monitoring equipment available and calibrated? <input type="checkbox"/> Yes <input type="checkbox"/> No</li> <li>• Is required rescue equipment available and inspected? <input type="checkbox"/> Yes <input type="checkbox"/> No</li> <li>• Do all personnel have required training? (including those not entering confined space) <input type="checkbox"/> Yes <input type="checkbox"/> No</li> <li>• Are all pertinent SDS available and have they been reviewed? <input type="checkbox"/> Yes <input type="checkbox"/> No</li> <li>• Are there any ventilation / equipment required? (i.e. air movers, nitrogen purge, etc.) <input type="checkbox"/> Yes <input type="checkbox"/> No</li> <li>• Have lockout and isolation points been verified and tested? <input type="checkbox"/> Yes <input type="checkbox"/> No</li> <li>• Have all required information and materials been provided to the contractor performing the confined space entry (if applicable): <input type="checkbox"/> Yes <input type="checkbox"/> No</li> </ul>                 Attachments:  <input type="checkbox"/> Hazard Assessment <input type="checkbox"/> Rescue Plan <input type="checkbox"/> SDS <input type="checkbox"/> Ventilation Plan (as required)  <input type="checkbox"/> Other: _____             </td> </tr> </table> <table style="width: 100%;"> <tr> <td style="width: 60%; padding: 2px;">                 Tester's Name: _____                  Testing Equipment/ Methods: _____                  Calibration Date: _____ Bump Date: _____                  Frequency of Atmospheric Testing (results must be recorded at the interval): _____                  Personal Monitors Required for Entrants? <input type="checkbox"/> Yes <input type="checkbox"/> No  <input type="checkbox"/> Continuous for O<sub>2</sub>, LEL, H<sub>2</sub>S, CO (mandatory)  <input type="checkbox"/> Other toxins to be tested: _____ Frequency of testing: _____                  _____ Frequency of testing: _____                  _____ Frequency of testing: _____                  Acceptable atmospheric levels for this space (O<sub>2</sub>, LEL, H<sub>2</sub>S, CO, benzene, etc): _____                  _____                  _____             </td> <td style="width: 40%; padding: 2px;"> <table border="1" style="width: 100%; border-collapse: collapse;"> <thead> <tr> <th style="text-align: left; font-size: 8px;">Initial Air Test</th> <th style="text-align: left; font-size: 8px;">Results</th> </tr> </thead> <tbody> <tr><td style="font-size: 8px;">O<sub>2</sub></td><td></td></tr> <tr><td style="font-size: 8px;">H<sub>2</sub>S</td><td></td></tr> <tr><td style="font-size: 8px;">LEL</td><td></td></tr> <tr><td style="font-size: 8px;">CO</td><td></td></tr> <tr><td style="font-size: 8px;">Benzene</td><td></td></tr> <tr><td style="font-size: 8px;">Other: _____</td><td></td></tr> <tr><td style="font-size: 8px;">Tester's Initials:</td><td></td></tr> </tbody> </table> </td> </tr> </table> <p style="font-size: 8px; margin-top: 5px;">Reminder: Tests shall be performed and recorded before a worker enters or re-enters the space. Initial testing must be performed no more than 20 minutes prior to an entry. Atmospheric testing must be repeated within 20 minutes of entry if a confined space is vacated for more than 20 minutes.</p>	<ul style="list-style-type: none"> <li>• Has the confined space location, hazards, and their controls, been reviewed and the confined space to be entered confirmed? <input type="checkbox"/> Yes <input type="checkbox"/> No</li> <li>• Has the hazard assessment been attached to the Permit? <input type="checkbox"/> Yes <input type="checkbox"/> No</li> <li>• Have all specific job responsibilities been assigned? (Indicate person responsible):                      Entry Supervisor – _____                      Equipment Lockout – _____                      Attendant – _____                      Atmospheric Testing – _____                      Preparation requirements completed prior to entry (cleaning, purging, venting, inerting, etc.): _____                      _____                      _____                      Conditions Under Which Entry is to be Terminated: _____                      _____                      _____                 </li> </ul>	<ul style="list-style-type: none"> <li>• Have all entry points into the confined space been identified and properly secured against unauthorized entry? <input type="checkbox"/> Yes <input type="checkbox"/> No</li> <li>• Is required monitoring equipment available and calibrated? <input type="checkbox"/> Yes <input type="checkbox"/> No</li> <li>• Is required rescue equipment available and inspected? <input type="checkbox"/> Yes <input type="checkbox"/> No</li> <li>• Do all personnel have required training? (including those not entering confined space) <input type="checkbox"/> Yes <input type="checkbox"/> No</li> <li>• Are all pertinent SDS available and have they been reviewed? <input type="checkbox"/> Yes <input type="checkbox"/> No</li> <li>• Are there any ventilation / equipment required? (i.e. air movers, nitrogen purge, etc.) <input type="checkbox"/> Yes <input type="checkbox"/> No</li> <li>• Have lockout and isolation points been verified and tested? <input type="checkbox"/> Yes <input type="checkbox"/> No</li> <li>• Have all required information and materials been provided to the contractor performing the confined space entry (if applicable): <input type="checkbox"/> Yes <input type="checkbox"/> No</li> </ul> Attachments: <input type="checkbox"/> Hazard Assessment <input type="checkbox"/> Rescue Plan <input type="checkbox"/> SDS <input type="checkbox"/> Ventilation Plan (as required) <input type="checkbox"/> Other: _____	Tester's Name: _____ Testing Equipment/ Methods: _____ Calibration Date: _____ Bump Date: _____ Frequency of Atmospheric Testing (results must be recorded at the interval): _____ Personal Monitors Required for Entrants? <input type="checkbox"/> Yes <input type="checkbox"/> No <input type="checkbox"/> Continuous for O <sub>2</sub> , LEL, H <sub>2</sub> S, CO (mandatory) <input type="checkbox"/> Other toxins to be tested: _____ Frequency of testing: _____ _____ Frequency of testing: _____ _____ Frequency of testing: _____ Acceptable atmospheric levels for this space (O <sub>2</sub> , LEL, H <sub>2</sub> S, CO, benzene, etc): _____ _____ _____	<table border="1" style="width: 100%; border-collapse: collapse;"> <thead> <tr> <th style="text-align: left; font-size: 8px;">Initial Air Test</th> <th style="text-align: left; font-size: 8px;">Results</th> </tr> </thead> <tbody> <tr><td style="font-size: 8px;">O<sub>2</sub></td><td></td></tr> <tr><td style="font-size: 8px;">H<sub>2</sub>S</td><td></td></tr> <tr><td style="font-size: 8px;">LEL</td><td></td></tr> <tr><td style="font-size: 8px;">CO</td><td></td></tr> <tr><td style="font-size: 8px;">Benzene</td><td></td></tr> <tr><td style="font-size: 8px;">Other: _____</td><td></td></tr> <tr><td style="font-size: 8px;">Tester's Initials:</td><td></td></tr> </tbody> </table>	Initial Air Test	Results	O <sub>2</sub>		H <sub>2</sub> S		LEL		CO		Benzene		Other: _____		Tester's Initials:	
<ul style="list-style-type: none"> <li>• Has the confined space location, hazards, and their controls, been reviewed and the confined space to be entered confirmed? <input type="checkbox"/> Yes <input type="checkbox"/> No</li> <li>• Has the hazard assessment been attached to the Permit? <input type="checkbox"/> Yes <input type="checkbox"/> No</li> <li>• Have all specific job responsibilities been assigned? (Indicate person responsible):                      Entry Supervisor – _____                      Equipment Lockout – _____                      Attendant – _____                      Atmospheric Testing – _____                      Preparation requirements completed prior to entry (cleaning, purging, venting, inerting, etc.): _____                      _____                      _____                      Conditions Under Which Entry is to be Terminated: _____                      _____                      _____                 </li> </ul>	<ul style="list-style-type: none"> <li>• Have all entry points into the confined space been identified and properly secured against unauthorized entry? <input type="checkbox"/> Yes <input type="checkbox"/> No</li> <li>• Is required monitoring equipment available and calibrated? <input type="checkbox"/> Yes <input type="checkbox"/> No</li> <li>• Is required rescue equipment available and inspected? <input type="checkbox"/> Yes <input type="checkbox"/> No</li> <li>• Do all personnel have required training? (including those not entering confined space) <input type="checkbox"/> Yes <input type="checkbox"/> No</li> <li>• Are all pertinent SDS available and have they been reviewed? <input type="checkbox"/> Yes <input type="checkbox"/> No</li> <li>• Are there any ventilation / equipment required? (i.e. air movers, nitrogen purge, etc.) <input type="checkbox"/> Yes <input type="checkbox"/> No</li> <li>• Have lockout and isolation points been verified and tested? <input type="checkbox"/> Yes <input type="checkbox"/> No</li> <li>• Have all required information and materials been provided to the contractor performing the confined space entry (if applicable): <input type="checkbox"/> Yes <input type="checkbox"/> No</li> </ul> Attachments: <input type="checkbox"/> Hazard Assessment <input type="checkbox"/> Rescue Plan <input type="checkbox"/> SDS <input type="checkbox"/> Ventilation Plan (as required) <input type="checkbox"/> Other: _____																				
Tester's Name: _____ Testing Equipment/ Methods: _____ Calibration Date: _____ Bump Date: _____ Frequency of Atmospheric Testing (results must be recorded at the interval): _____ Personal Monitors Required for Entrants? <input type="checkbox"/> Yes <input type="checkbox"/> No <input type="checkbox"/> Continuous for O <sub>2</sub> , LEL, H <sub>2</sub> S, CO (mandatory) <input type="checkbox"/> Other toxins to be tested: _____ Frequency of testing: _____ _____ Frequency of testing: _____ _____ Frequency of testing: _____ Acceptable atmospheric levels for this space (O <sub>2</sub> , LEL, H <sub>2</sub> S, CO, benzene, etc): _____ _____ _____	<table border="1" style="width: 100%; border-collapse: collapse;"> <thead> <tr> <th style="text-align: left; font-size: 8px;">Initial Air Test</th> <th style="text-align: left; font-size: 8px;">Results</th> </tr> </thead> <tbody> <tr><td style="font-size: 8px;">O<sub>2</sub></td><td></td></tr> <tr><td style="font-size: 8px;">H<sub>2</sub>S</td><td></td></tr> <tr><td style="font-size: 8px;">LEL</td><td></td></tr> <tr><td style="font-size: 8px;">CO</td><td></td></tr> <tr><td style="font-size: 8px;">Benzene</td><td></td></tr> <tr><td style="font-size: 8px;">Other: _____</td><td></td></tr> <tr><td style="font-size: 8px;">Tester's Initials:</td><td></td></tr> </tbody> </table>	Initial Air Test	Results	O <sub>2</sub>		H <sub>2</sub> S		LEL		CO		Benzene		Other: _____		Tester's Initials:					
Initial Air Test	Results																				
O <sub>2</sub>																					
H <sub>2</sub> S																					
LEL																					
CO																					
Benzene																					
Other: _____																					
Tester's Initials:																					
Part 4: Onsite Execution & Rescue	Are we using an internal Enbridge team for rescue? <input type="checkbox"/> Yes <input type="checkbox"/> No External Third Party Rescue: <input type="checkbox"/> Yes <input type="checkbox"/> No If yes, name of external vendor: _____ How is the rescue team summoned or communicated with (cellphone / radio, etc.): _____ Equipment required for rescue: _____ Nearest Medical Facility: _____ Names of Rescue Team Members: _____ _____ _____																				
Part 5: Approvals	Work cannot begin until the required signatures are on this document. All persons performing this work must comply with Enbridge safety policies and government regulations. Work must stop should conditions change/new hazards appear or an emergency occurs on the site.																				
Part 5: Approvals	<table style="width: 100%;"> <tr> <td style="width: 33%; padding: 2px;"> <b>Permit Issuer</b>                      Print Name: _____                      Signature: _____                 </td> <td style="width: 33%; padding: 2px;"> <b>Permit Approver / Entry Supervisor</b>                      Print Name: _____                      Signature: _____                 </td> <td style="width: 33%; padding: 2px;"> <b>Permit Receiver</b>                      Print Name: _____                      Signature: _____                 </td> </tr> </table> <p style="font-size: 8px; margin-top: 5px;">By signing this permit, the receiver acknowledges that all safety requirements have been met, have been reviewed with the workers, will be maintained for the duration of the permit and it is safe to proceed with the work. All workers associated with the work must sign in the area provided on the back of the permit during the pre-job entry meeting.</p> Record of Permit Closure: Job Completed? <input type="checkbox"/> Yes <input type="checkbox"/> No Have all personnel vacated the space? <input type="checkbox"/> Yes <input type="checkbox"/> No Have all tools/equipment been removed from the space? <input type="checkbox"/> Yes <input type="checkbox"/> No Permit Extension: Is the planned work expected to exceed 12 hours? _____	<b>Permit Issuer</b> Print Name: _____ Signature: _____	<b>Permit Approver / Entry Supervisor</b> Print Name: _____ Signature: _____	<b>Permit Receiver</b> Print Name: _____ Signature: _____																	
<b>Permit Issuer</b> Print Name: _____ Signature: _____	<b>Permit Approver / Entry Supervisor</b> Print Name: _____ Signature: _____	<b>Permit Receiver</b> Print Name: _____ Signature: _____																			



Part 6: Pre-Entry Meeting:																																	
Confined Space Entry Supervisor or Designate (print and sign): _____ This signature authorizes the entry of the following workers into the confined space.																																	
<table border="1" style="width: 100%; border-collapse: collapse;"> <thead> <tr> <th colspan="3">Workers Involved (print and sign)</th> </tr> </thead> <tbody> <tr><td>1. _____</td><td>8. _____</td><td>15. _____</td></tr> <tr><td>2. _____</td><td>9. _____</td><td>16. _____</td></tr> <tr><td>3. _____</td><td>10. _____</td><td>17. _____</td></tr> <tr><td>4. _____</td><td>11. _____</td><td>18. _____</td></tr> <tr><td>5. _____</td><td>12. _____</td><td>19. _____</td></tr> <tr><td>6. _____</td><td>13. _____</td><td>20. _____</td></tr> <tr><td>7. _____</td><td>14. _____</td><td>21. _____</td></tr> </tbody> </table>										Workers Involved (print and sign)			1. _____	8. _____	15. _____	2. _____	9. _____	16. _____	3. _____	10. _____	17. _____	4. _____	11. _____	18. _____	5. _____	12. _____	19. _____	6. _____	13. _____	20. _____	7. _____	14. _____	21. _____
Workers Involved (print and sign)																																	
1. _____	8. _____	15. _____																															
2. _____	9. _____	16. _____																															
3. _____	10. _____	17. _____																															
4. _____	11. _____	18. _____																															
5. _____	12. _____	19. _____																															
6. _____	13. _____	20. _____																															
7. _____	14. _____	21. _____																															
<table border="1" style="width: 100%; border-collapse: collapse;"> <thead> <tr> <th colspan="5">Topics to be reviewed (as applicable):</th> </tr> </thead> <tbody> <tr> <td colspan="5"> <input type="checkbox"/> Hazard Assessment and Controls (Mandatory Review)  <input type="checkbox"/> Rescue plan (Mandatory Review)  <input type="checkbox"/> Confined Space Classification  <input type="checkbox"/> Confined Space Entry Checklist  <input type="checkbox"/> Procedures/plans to be followed  <input type="checkbox"/> Permit Requirements  <input type="checkbox"/> Communication Systems                             </td> </tr> <tr> <td colspan="5"> <input type="checkbox"/> Air Testing Requirements  <input type="checkbox"/> Confined Space Attendant Responsibilities  <input type="checkbox"/> Ventilation  <input type="checkbox"/> Required personal protective and respiratory equipment required for entry  <input type="checkbox"/> Entrant tracking requirements (sign in/out with confined space attendant)  <input type="checkbox"/> Conditions under which entry is not allowed or must be terminated  <input type="checkbox"/> Emergency equipment and inspection of equipment  <input type="checkbox"/> Isolation of energy sources and control of materials movement                             </td> </tr> </tbody> </table>										Topics to be reviewed (as applicable):					<input type="checkbox"/> Hazard Assessment and Controls (Mandatory Review) <input type="checkbox"/> Rescue plan (Mandatory Review) <input type="checkbox"/> Confined Space Classification <input type="checkbox"/> Confined Space Entry Checklist <input type="checkbox"/> Procedures/plans to be followed <input type="checkbox"/> Permit Requirements <input type="checkbox"/> Communication Systems					<input type="checkbox"/> Air Testing Requirements <input type="checkbox"/> Confined Space Attendant Responsibilities <input type="checkbox"/> Ventilation <input type="checkbox"/> Required personal protective and respiratory equipment required for entry <input type="checkbox"/> Entrant tracking requirements (sign in/out with confined space attendant) <input type="checkbox"/> Conditions under which entry is not allowed or must be terminated <input type="checkbox"/> Emergency equipment and inspection of equipment <input type="checkbox"/> Isolation of energy sources and control of materials movement													
Topics to be reviewed (as applicable):																																	
<input type="checkbox"/> Hazard Assessment and Controls (Mandatory Review) <input type="checkbox"/> Rescue plan (Mandatory Review) <input type="checkbox"/> Confined Space Classification <input type="checkbox"/> Confined Space Entry Checklist <input type="checkbox"/> Procedures/plans to be followed <input type="checkbox"/> Permit Requirements <input type="checkbox"/> Communication Systems																																	
<input type="checkbox"/> Air Testing Requirements <input type="checkbox"/> Confined Space Attendant Responsibilities <input type="checkbox"/> Ventilation <input type="checkbox"/> Required personal protective and respiratory equipment required for entry <input type="checkbox"/> Entrant tracking requirements (sign in/out with confined space attendant) <input type="checkbox"/> Conditions under which entry is not allowed or must be terminated <input type="checkbox"/> Emergency equipment and inspection of equipment <input type="checkbox"/> Isolation of energy sources and control of materials movement																																	
Pre-Entry Meeting Notes:   																																	
Part 7: Periodic Atmospheric Testing Results																																	
Time of Test																																	
Tester's Name																																	
Tester's Initials																																	
O <sub>2</sub>																																	
H <sub>2</sub> S																																	
LEL																																	
CO																																	
Benzene																																	
Other (Specify) _____																																	
Other (Specify) _____																																	
Part 8: Entrant Tracking (Completed by the Confined Space Attendant)																																	
Confined Space Attendant Name: _____					Confined Space Attendant Signature: _____																												
Entrant Name (First and Last)	Entry Time	Exit Time	Entry Time	Exit Time	Entry Time	Exit Time	Entry Time	Exit Time	Exit Time																								
1.																																	
2.																																	
3.																																	
4.																																	
5.																																	
6.																																	
7.																																	
8.																																	
9.																																	
10.																																	
11.																																	
12.																																	
13.																																	
14.																																	
15.																																	
16.																																	
Confined Space Attendant Notes: <input type="checkbox"/> Communication system with entrants: _____ <input type="checkbox"/> Communication system with Entry Supervisor: _____ <input type="checkbox"/> Communication system with rescue team: _____																																	

## CHANGE LOG

Section	Version 3.0	Version 3.1
Entire document		Clerical corrections, including spelling grammar, and document names.
6.2, 6.8.3		Updated terminology from incident and investigation to event and analysis.
6.1.3		Clerical corrections. Previous version used the following terms, which are from the US CSE standard and not defined within this standard: alternate entry, non-permit required confined space, and permit required confined space. The appropriate terms for the Canadian CSE standard are: low hazard atmosphere, medium hazard atmosphere, and high hazard atmosphere confined space.

<END OF DOCUMENT>



---

# Standard

---

## Confined Space – United States

---

**Effective Date:** 2019-10-31  
**Version #:** 2.2  
**Version Date:** 2024-03-28

---



This page intentionally left blank



**Document Version Register**

Version Number	Version Date	Approved By	Section Number and Title	Details of Version
1.0	2019-08-14	Sean Evans	Whole Document (New Standard)	This is the new H&S standard that was developed as part of the LP   MP Safety Manual Transition Project
1.1	2019-10-31	Sean Evans		See Change Log
1.2	2020-06-01	Sean Evans	2.0, 5.0	Alignment with Contractor Safety Specifications
1.3	2021-12-01	Murray Evenson	9.0, 10.0	Updated section 9 to reflect the appropriate review process Updated section 10.0 – Added reference
2.0	2022-08-30	Murray Evenson	6.4.7	Updates to section 6.4.7 (see change log)
2.1	2023-04-18	Murray Evenson	6.4.2, 6.4.7	Updates to section 6.4.2 and 6.4.7 (see change log)
2.2	2024-03-28	Troy Croft	6.2, 6.7.3, 6.9.2 All sections	Alignment with Management System Framework - Event Analysis. Clerical Corrections.



This page intentionally left blank

---

## Table of Contents

1.0	Purpose .....	3
2.0	Scope .....	3
3.0	Prerequisite .....	3
4.0	Definitions & Acronyms .....	3
5.0	Roles & Responsibilities .....	6
6.0	Standard – Specific Requirements .....	12
6.1	Confined Space Inventory Requirements .....	12
6.1.1	Spaces Included in the Inventory .....	12
6.2	Confined Space Hazard Assessment .....	12
6.3	Control of Hazards .....	15
6.4	Types and Classifications of Confined Spaces .....	15
6.4.1	Three Categories for Confined Space Entry .....	16
6.4.2	Confined Space Requirements .....	18
6.4.3	Temporary Declassified Space .....	19
6.4.4	Trenches and Excavations .....	19
6.4.5	Minimal Depth Whistles/Vertical Culverts .....	19
6.4.6	Small Piping .....	20
6.4.7	External Floating Tank Roofs .....	20
6.5	Confined Space Entry Plan .....	21
6.6	Pre Entry Meeting .....	21
6.7	Confined Space Entry Permit .....	22
6.7.1	Confined Space Permit Roles .....	23
6.7.2	Terminating an Entry .....	28
6.7.3	Permit Document Copies .....	28
6.8	Work Practices .....	29
6.8.1	Preventing Unauthorized Entry .....	29
6.8.2	Atmospheric Testing/Monitoring .....	29
6.8.3	IDLH Atmosphere .....	31



---

6.8.4	Inerting .....	31
6.8.5	Ventilation Requirements.....	31
6.8.6	Hot Work.....	33
6.8.7	Isolation Requirements .....	34
6.9	Confined Space Rescue.....	34
6.9.1	Internal Rescue Teams.....	35
6.9.2	Third Party Rescue Teams .....	36
6.9.3	Rescue Plan .....	37
6.10	Confined Space Closure Requirements .....	37
6.11	Confined Space Package.....	38
7.0	Training.....	38
8.0	Related Documents .....	39
9.0	Standard Review .....	39
10.0	References .....	39
11.0	Appendix.....	40
11.1	Identification of a Confined Space.....	40
11.2	Confined Space Entry Permit .....	41
11.3	Confined Space Rescue Plan – Template .....	43
11.4	Confined Space Rescue Plan – Template .....	46
	Change Log.....	50

---

## **1.0 PURPOSE**

The purpose of this standard is to ensure that Enbridge Workforce understands the hazards and requirements associated with confined spaces.

Enbridge will inform contractors and subcontractors of confined space locations, elements, precautions, procedures, and coordinate all entries into confined spaces.

## **2.0 SCOPE**

This Standard applies to all employees within Liquids Pipelines and Projects in the United States who are involved in confined space work.

Contractors and subcontractors shall comply with Enbridge health and safety requirements set out in this standard, as articulated within applicable contractor safety specifications. If a contractor or subcontractor has a health and safety standard or policy materially different from Enbridge's, the contractor/subcontractor shall follow the most stringent requirement. Contractors and subcontractors are still obligated to meet the requirements of all applicable laws related to this standard.

In the event a contractor's or subcontractor's standard exceeds the requirements of this standard, Enbridge may, in its sole discretion, choose to adopt the contractor's or subcontractor's standard for any given contract or work order. Contractors may use their own confined space entry permits, confined space entry plans, and confined space entry rescue plans.

## **3.0 PREREQUISITE**

- Atmospheric Monitoring Standard
- Control of Hazardous Energy Standard
- Emergency Preparedness – Personal Safety Standard
- Fall Protection Standard
- Hazard Assessment and Control Standard
- Hot Work and Ignition Sources
- Immediately Dangerous to Life and Health Atmospheres Procedure
- Personal Protective Equipment Standard
- Respiratory Protection Standard
- Safe Work Permits and Work Authorization

## **4.0 DEFINITIONS & ACRONYMS**

*Acceptable Entry Conditions* - the conditions that must exist in a permit space to allow entry and to ensure that workers involved with a permit required confined space entry can safely enter and

exit into and work within the space. Prior to an entry, all access points for entry and exit will need to be determined.

*Blanking* – isolation method for the absolute closure of piping that involves inserting a physical barrier through the cross-section of pipe so material is prevented from flowing past that point. Blanks shall be of sufficient rating to withstand the highest possible pressure that may result.

*Blinding* – isolation method for the absolute closure of piping that involves disconnecting a pipe and attaching a physical barrier to the end so material is prevented from flowing out of the pipe. Blind flanges used for this purpose shall be of sufficient rating to withstand the highest possible pressure that may result.

*Confined Space* - a space that:

- Is large enough and so configured that a person can bodily enter and perform assigned work; and
- Has limited or restricted means for entry or exit (for example, tanks, vessels, silos, storage bins, hoppers, vaults, and pits are spaces that may have limited means of entry); and
- Is not designed for continuous employee occupancy.

*Confined Space Attendant* - a qualified worker who is stationed outside one or more permit spaces who monitors the authorized entrants and who performs all attendants' duties assigned in the employer's permit space program.

*Confined Space Authorized Entrant* - a qualified worker who is authorized by the employer to enter a space.

*Confined Space Entry Supervisor* - the qualified person responsible for determining if acceptable entry conditions are present at a confined space where entry is planned, for authorizing entry and overseeing entry operations, and for terminating entry as required by this section.

\*Note: An Entry Supervisor also may serve in additional roles as long as that person is trained and equipped as required by this section for each role he or she fills. Also, the duties of Entry Supervisor may be passed from one individual to another during the course of an entry operation.

*Emergency* - any occurrence (including any failure of hazard control or monitoring equipment) or event internal or external to the permit space that could endanger authorized entrants.

*Enbridge Representative* – employee or third-party hire representing Enbridge for specific contractor work or project.

*Engulfment* - the surrounding and effective capture of a person by a liquid or finely divided (flowable) solid substance that can be aspirated to cause death by filling or plugging the respiratory system or that can exert enough force on the body to cause death by strangulation, constriction, or crushing.

*Entry* - the action by which a qualified person passes through an opening into a permit required confined space. Entry includes ensuing work activities in that space and is considered to have occurred as soon as any part of the authorized entrant's body breaks the plane of an opening into the space.

*Entry Permit* - the written or printed document that allows and controls entry into a confined space.

*Flammable Atmosphere* - any atmosphere that contains 10% or more of the Lower Explosive Limit (LEL), or Lower Flammable Limit (LFL) for any substance.

*Hazardous Atmosphere* - An atmosphere which exposes an individual to a risk of injury, illness, disablement, or death due to one or more of the following causes:

- A flammable gas/vapor concentration in excess of 10% of its lower explosive limit (LEL)
- An atmospheric oxygen concentration below 19.5% or above 23.5%.
- An atmospheric concentration of any substance above the exposure limits established by the governing regulatory body or as indicated on the Safety Data Sheet (SDS)
- Airborne combustible dust at a concentration that meets or exceeds its LFL;  
Note: This concentration may be approximated as a condition in which the dust obscures vision at a distance of 5 feet (1.52 m) or less.

*Hot Work* - Any process that can be a source of ignition when flammable material is present or can be a fire hazard regardless of the presence of flammable material.

*Immediately Dangerous to Life and Health (IDLH) Atmosphere*- An atmospheric concentration of any toxic, corrosive or asphyxiant substance that poses an immediate threat to life or would cause irreversible or delayed adverse health effects or would interfere with an individual's ability to escape from a dangerous/hazardous atmosphere.

*Inerting* - the displacement of the atmosphere in a permit space by a non-combustible gas (such as nitrogen) to such an extent that the resulting atmosphere is non-combustible.

Note: This procedure produces an IDLH oxygen-deficient atmosphere.

*Isolated* - Sources of energy have been disconnected or controlled.

*Isolation* - the process by which a confined space is removed from service and completely protected against the release of energy and material into the space by such means as: blanking or blinding; misaligning or removing sections of lines, pipes, or ducts; a double block and bleed system; lockout or tagout of all sources of energy; or blocking or disconnecting all mechanical linkages.

*LOTO* – lockout tagout

*Lower Explosive Limit (LEL)* - The lowest concentration (percentage) of a gas or a vapor in air capable of producing a flash of fire in presence of an ignition source (arc, flame, heat). At a concentration in air below the LEL there is not enough fuel to continue an explosion. Concentrations lower than the LEL are "too lean" to explode but may still burn with great heat and light. Exact values can be found on product's Safety Data Sheet (SDS).

*LFL* – Lower Flammable Limit

*Non-Permit Confined Space* - means a confined space that does not contain or, with respect to atmospheric hazards, have the potential to contain any hazard capable of causing death or serious physical harm. This includes temporarily reclassified confined spaces.

*Oxygen Deficient Atmosphere* - means an atmosphere containing less than 19.5% oxygen by volume.

*Oxygen Enriched Atmosphere* - means an atmosphere containing more than 23.5% oxygen by volume.

*PPE* – Personal Protective Equipment

*Permit required confined space* - means a confined space that has one or more of the following characteristics:

- Contains or has a potential to contain a hazardous atmosphere;
- Contains a material that has the potential for engulfing an entrant;
- Has an internal configuration such that an entrant could be trapped or asphyxiated by inwardly converging walls or by a floor which slopes downward and tapers to a smaller cross-section; or
- Contains any other recognized serious safety or health hazard.

*Prohibited Condition* - means any condition in a permit space that is not allowed by the permit during the period when entry is authorized.

*Qualified Worker* - Confined Space Roles – A worker who has acquired the understanding, knowledge and skills necessary for the safe performance of the assigned confined space duties.

*Rescue Team* - means the personnel designated to rescue workers from permit spaces.

*Retrieval system* - means the equipment (including a retrieval line, chest or full-body harness, wristlets or anklets, if appropriate, and a lifting device or anchor) used for non-entry rescue of persons from permit spaces.

*SABA* – Supplied Air Breathing Apparatus

*SCBA* – Self-Contained Breathing Apparatus

*SWP* – Safe Work Permit

*Toxic Atmosphere* – means an atmospheric concentration of any substance above the exposure limits established by the governing regulatory body or as indicated on the Safety Data Sheet (SDS).

## **5.0 ROLES & RESPONSIBILITIES**

Enbridge Management and Contractor Management as articulated within the applicable contractor safety specifications shall:

- Ensure compliance with all Applicable Legislation and Enbridge requirements including, but not limited to:
  - ensuring work is conducted in accordance with this Standard, Confined Space Entry Permit, Entry Plan and Hazard Assessments, and any procedures established as a result of this Standard
  - ensuring an Entry Supervisor who is qualified is assigned for each confined space entry
  - ensuring all Workers involved in Confined Space work are qualified and have completed applicable Confined Space training
  - ensuring Confined Space rescue plans are developed prior to an entry
  - ensuring all required documentation applicable to Confined Space entry is developed, completed and maintained, in accordance with Enbridge requirements and applicable Legislation
  - ensuring all resources (e.g., personnel, equipment, personal protective equipment (PPE)) required for each Confined Space Entry are readily available
  - ensure that contractors are informed of the hazards and controls associated with confined space entries.

Enbridge Operations shall:

- Identify all existing permanent confined spaces at their physical locations
- Identify potential confined spaces created by work (e.g. pipe entry during cut out work)
- Maintain a written inventory of existing permanent Confined Spaces at the Enbridge locations they manage (e.g., at assigned Worksites; or for a Region), or document the Confined Spaces on their site safety plot plan
- Review and update the inventory or site safety plot plan for confined spaces at least once every 5 years, to verify accuracy
- Ensure compliance with the signage requirements for existing permanent confined spaces
- Follow all procedures and standards when performing a confined space entry
- Maintain communications with the contractor throughout the planning, execution and completion of confined space activities.
- Debrief the contractor at the conclusion of the entry operations regarding any hazards confronted or created in during entry operations.

Enbridge Projects shall:

- Identify all confined spaces for their project work
- Coordinate all confined space entries with Operations for sites Operations has ownership of

- Coordinate contractor confined space entries on their sites with the work group who is performing the work
- Ensure compliance with the signage requirements for confined spaces
- Follow all procedures and standards when performing a confined space entry
- Maintain communications with the contractor throughout the planning, execution and completion of confined space activities.
- Debrief the contractor at the conclusion of the entry operations regarding any hazards confronted or created in during entry operations.

Entry Supervisor at a minimum shall:

- Ensure all confined space entry and regulatory requirements are met prior to the confined space entry permit being issued.
- Verify compliance with the requirements on the Confined Space Entry Permit
- Ensure all workers are qualified to perform their assigned tasks and roles
- Know the hazards that may be faced during entry work, including information on the potential modes of exposure, plus the signs, symptoms and consequences of different exposures
- Ensure a hazard assessment is completed prior to entry and review the hazard assessment with the workers. This process includes a FLHA at a minimum. If a JHA or a confined space hazard assessment exists, it should be reviewed with the workers.
- Conduct the confined space pre-job entry meeting
- Conduct and oversee the work in accordance with the pre-job entry meeting if applicable
- Ensure workers follow the requirements set out during the Pre-Job Entry Meeting if applicable
- Ensure adequate steps have been taken to eliminate and/or control all present or potential hazards
- Verify hazard controls are implemented and effective
- Ensure all required atmospheric monitoring and testing has been completed as required by the hazard assessment and confined space plan and is properly documented
- Ensure that rescue personnel, plans, and equipment are in place if applicable
- Ensure there is a suitable means of communication among workers

- Ensure that acceptable conditions are maintained for the duration of the entry work and that any requirements or status changes are communicated to the next Entry Supervisor if applicable
- Terminate the confined space entry and permit if conditions warrant termination

Note: this role can be either an Enbridge employee or contractor. A contractor Entry Supervisor cannot be the approver on an Operations-generated Confined Space Permit. The approver will be either operations or projects.

Confined Space Attendant at a minimum shall:

- Attend and participate in the confined space pre-job entry meeting
- Review the entry and rescue procedures, being aware of all confined space entry permit and hazard assessment requirements and ensuring all requirements are followed
- Be aware of the hazards of the confined space being entered
- Be aware of the signs and symptoms of exposures and the possible behavioral or other effects of exposure
- Ensure they have an effective means of constant communication with the workers entering the confined space, the emergency rescue personnel and the Entry Supervisor at all times
- Ensure initial and ongoing air testing occurs, as required, and recording the test results on the confined space entry permit
- Ensure entry points are kept clean and clear
- Control access to the confined space and prohibit entry to unauthorized workers
- Track and record on the confined space entry permit, all personnel entering and exiting a confined space, and controlling the number of authorized entrants within the space as required by the confined space entry permit
- Be aware of hazardous, prohibited or unacceptable conditions that require evacuation of the space
- Be prepared to initiate evacuation from the space, as necessary, due to actual or potential hazards (this could include hazards within the space and also in the vicinity of the space that could affect the health and safety of workers)
- Ensure the space has been completely evacuated in the event of an emergency
- Request rescue and other emergency services when necessary, e.g., as soon as it is determined that workers in a confined space may need assistance to evacuate; or, if a situation arises outside the confined space that could endanger the workers inside or near the confined space



- Not enter a confined space for any reason or leave the entrance to a confined space, unless relieved by another designated and qualified attendant
- Not enter the space to perform rescue operations, if qualified for rescue work in accordance with the rescue procedure for that confined space unless they have been relieved by another attendant
- Not perform other duties which might interfere with their primary duty to monitor and protect the authorized entrants working in the space, unless they are performing non-entry rescue in accordance with the rescue procedure
- Verify that no person is inside the confined space before it is closed off, and shall ensure proper signage/barricades are in place to prevent unauthorized entry into the confined space prior to leaving the entrance of a confined space

Authorized Entrant at a minimum shall:

- Attend and participate in the confined space pre-job entry meeting
- Review the entry and rescue procedures, being aware of all confined space entry permit and hazard assessment requirements and ensuring all requirements are followed
- Be aware of the hazards of the confined space being entered
- Immediately notify the Entry Supervisor when they do not feel qualified to perform a task or assigned duty
- Conduct work as directed by the Entry Supervisor, and in accordance with company requirements
- Alert the Entry Supervisor when a hazard has not been adequately controlled
- Be aware of the signs and symptoms of exposures and the possible behavioral or other effects
- Maintain communication with the attendant and immediately notify the attendant if an emergency or a hazardous, prohibited or unacceptable condition requires evacuation of the confined space
- Exit the space as quickly as possible when any of the following occurs:
  - The attendant gives the order to evacuate the space
  - An emergency
  - A hazardous, prohibited or unacceptable condition is detected
  - An evacuation alarm is activated
- Properly use equipment

- 
- Wear/use the required equipment (e.g., PPE, respiratory protection equipment, rescue equipment) properly, in a safe manner and at all times
  - Know the limitations of equipment used to control hazards related to confined space entry work
  - Sign in and sign out of the confined space with the attendant

Rescue Personnel at a minimum shall:

- Ensure all retrieval equipment is in good working order
- Ensure that the proper rescue equipment is readily available and in close proximity to the confined space.
- Write or be involved in the writing and review of the confined space rescue plan
- Review the confined space and understands the hazards and controls

Entry Coordinator for Contractors shall:

- Coordinate the planning for a confined space entry.
- Communicate and coordinate with contractors when contractors are performing a confined space entry.
- Provide the Permit Issuer with adequate notice of intended entry to review scope, hazards and confined space documentation.
- Communicate with Operations
- Communicate with the contractor as applicable
- Communicate with the Entry Supervisor
- Ensure all information on the confined space is obtained from Operations and provided to the contractor and Entry Supervisor
- Coordinate isolation with Operations if applicable
- Review the contractor's confined space entry program/procedures applicable to the work
- Review the contractor's rescue plan
- Ensure all policies and procedures are followed.

Note: The individual performing this role should be from the work group that is hiring the contractor. The role does not need to be onsite during any time of the actual confined space entry.

---

## **6.0 STANDARD – SPECIFIC REQUIREMENTS**

### **6.1 CONFINED SPACE INVENTORY REQUIREMENTS**

A confined space inventory must be developed and maintained at the work location. The confined space inventory must be:

- Retained onsite according to Enbridge record retention policies.
- Updated as processes, operations, equipment and other circumstances change.
  - This includes any modifications to any of these that may create or alter a confined space.
- Reviewed every three years. This review should consider:
  - If all existing permanent confined spaces on the worksite have been identified.
  - If all identified spaces fit the criteria of a Confined Space.

A confined space hazard assessment may be required to make a final judgment on whether a space fits the technical criteria for a confined space. Regions are encouraged to complete a confined space hazard assessment for each existing permanent confined space. These confined space hazard assessments must be reviewed every three years and updated as necessary, e.g., confined space entry has been terminated due to atmosphere.

#### **6.1.1 SPACES INCLUDED IN THE INVENTORY**

The inventory will contain all spaces that a worker may enter and any space that has been assessed. As spaces are assessed the inventory should then clearly indicate whether:

- The space fits the criteria of a Confined Space and will be subject to this procedure for worker entry, or
- The space has been deemed to fall outside the criteria of a Confined Space.

Note: Spaces can be “grouped” and dealt with as a “type of space” for the purposes of the inventory and hazard assessment and procedures if they have the same configuration, function, and hazards.

### **6.2 CONFINED SPACE HAZARD ASSESSMENT**

A confined space hazard assessment is encouraged to identify hazards and controls with existing permanent confined spaces.

When completing a confined space hazard assessment, the qualified worker is responsible for identifying and assessing existing and potential hazards specific to the work activity and related job tasks that may exist due to the design, construction, location, use or contents of the confined space that may develop while work is done inside the confined space.

If two or more confined spaces are of similar construction and present the same hazards, their confined space hazard assessments may be recorded in a single document, but each confined space shall be clearly identified in the assessment.

For Permit Required Confined Spaces the confined space hazard assessment must also consider specified risks including:

- the conditions which may exist prior to entry due to the confined space's design, location or use, or which may develop during work activity inside the space, and
- the potential for oxygen enrichment and deficiency, flammable gas, vapour or mist, combustible dust, other hazardous atmospheres, harmful substances requiring lockout and isolation, engulfment and entrapment, physical and configuration hazards, emergency response limitations, and other hazardous conditions.

Factors to be considered in the confined space hazard assessment include:

- Hazardous atmospheres either as a normal characteristic of the space or as the product of the required work processes to be conducted in the space:
  - Oxygen Deficiency or Enrichment: Oxygen deficiency may be caused by consumption by workers, oxidation (rusting) process, burning, welding, or bacteria, or by the absorption by chemicals or products. An oxygen deficient atmosphere is one that contains less than 19.5% oxygen. Oxygen enrichment may be caused by leaking of oxygen into the space or generation by chemical processes. An oxygen enriched atmosphere is one that contains more than 23.5% oxygen.
  - Asphyxiates: Inert gases can dilute or displace oxygen below a safe level (e.g., methane, carbon monoxide, carbon dioxide, nitrogen) during purging or by leaking into the confined space due to improper isolation and lockout.
  - Toxicity: Gases (H<sub>2</sub>S, Methane, CO, etc.), vapours, dusts, or fumes that have a poisonous effect from operations such as cleaning, painting, coating, etc., or from gases like methane or H<sub>2</sub>S leaking into the confined space. Carbon monoxide may be generated by internal combustion engines within the confined space or running near air intakes for the ventilator in use. A toxic atmosphere is an atmospheric concentration of any substance above the exposure limits established by the governing regulatory body or as indicated on the Safety Data Sheet (SDS).
  - Flammable or Explosive Atmospheres: Flammable gases (methane, ethane, etc.), vapors, dust that could be ignited by an uncontrolled ignition source. This risk increases if an oxygen-enriched atmosphere (23.5% by volume) is present.
  - Vapors, Mists, or Dusts.
- Harmful energy sources requiring isolation and lockout to ensure they remain in a zero-energy state.

- 
- Uncontrolled introduction of water, liquids, steam, or gases (improper control of water, steam, or pressurized gases introduced during cleaning or surface preparation work).
  - Contact with moving parts (being trapped or crushed by moving parts not properly isolated/locked out).
  - Crushing/Engulfment or entrapment (risk of becoming trapped or buried by internal components or bulk materials).
  - Entry and exit to the confined space sufficient for emergency egress and size adequate to allow personnel wearing respiratory equipment, if required by conditions.
  - Other hazards resulting from work or equipment being used, such as:
    - Electrical hazards (including static),
    - Excessive temperatures - heat or cold,
    - Noise,
    - Falls/slips,
    - Radiation,
    - Direct contact with corrosives,
    - Iron sulphide (pyrophoric material), or
    - Biological substances (e.g., bird or rodent droppings) or stinging/biting insects and snakes.
  - Tools required to be used in the work.

If a hazardous condition develops in a space during the entry, the work activity will be suspended and the confined space hazard assessment will need to be reviewed and updated as applicable before work resumes in the confined space.

The confined space hazard assessment review shall evaluate the effectiveness of hazard assessment process regarding the confined space and the suitability of established controls. The review of controls shall be based on relevant factors, such as:

- changes in workplace conditions or work activities
- workplace inspection reports
- injury statistics
- event analyses
- the applicable Safety Data Sheet (SDS) of any hazardous products that were contained in the Confined Space or that could be released.

---

## 6.3 CONTROL OF HAZARDS

Risks associated with a confined space may be reduced by:

- Elimination:
  - Eliminate the confined space by eliminating the need to enter the space
  - Eliminate the confined space by modifying the configuration of the space.
- Substitution:
  - Utilizing tools in lieu of a traditional entry
  - Confined space work is contracted to a qualified contractor to perform
- Engineering Controls:
  - Ventilation to maintain the oxygen level between 19.5% and 23.5%
  - Ventilation to ensure clean breathable air is continuously blown into the space
  - Isolation to remove or separate equipment from all energy sources and appropriate control the energy through lockout
  - Eliminate the confined space by modifying the configuration of the space
  - Providing pedestrian, vehicle, or other barriers as necessary to protect entrants from external hazards
- Administrative Controls
  - Procedures for continuous atmospheric monitoring
  - Permits and planning for confined space entry and rescue
  - Procedures and guidelines for confined space entry
- Personal Protective Equipment (PPE)
  - Personnel may be required to wear an appropriate level of respiratory protection, full body harness, lifeline, and other PPE as necessary that is identified in the hazard assessment and as per company policy. A harness and lifeline should be worn to facilitate non-entry rescue at all times unless the retrieval equipment would increase the overall risk of entry or would not contribute to the rescue of the entrant. Guidance on proper selection of PPE is covered in Personal Protective Equipment, Fall Protection and Respiratory Protection Standards.
  - The Respiratory Protection Standard, Section 11.3, outlines the minimum respiratory protection requirements for exposures.

## 6.4 TYPES AND CLASSIFICATIONS OF CONFINED SPACES

Confined spaces are at most locations. Spaces that typically meet the definition of confined spaces on the company's property include, but are not limited to:

- Tanks
- Vaults
- Culverts
- Pressure vessels
- Pits
- Some parts of machinery
- Ventilation systems
- Access openings (manholes)
- Pipes
- Towers (heaters)
- Railway tank cars

When considering work that must be performed inside a Confined Space, the following priorities should be followed:

1. If possible, conduct the work from outside the Confined Space (i.e., avoid Entry altogether)
2. If #1 is not possible, remove all hazards capable of causing death or physical injury and any potential for a hazardous atmosphere to permanently or temporarily classify the Confined Space as a Non-Permit Required Confined Space.
3. If #2 is not possible, remove all hazards capable of causing death or physical injury and use mechanical ventilation as necessary to prevent a hazardous atmosphere to allow for an Alternate Entry into a Permit Required Confined Space.

Whenever feasible, eliminate atmospheric or other hazards and confirm hazards have been eliminated from the confined space from outside the confined space to avoid entry.

- Where entry is required to eliminate hazards and/or to confirm hazards are eliminated, the entry must be performed under the Permit Required Confined Space Standard Entry procedure.

When determining if a space is a confined space, see Appendix 11.1 Identification of a Confined Space for additional guidance.

#### **6.4.1 THREE CATEGORIES FOR CONFINED SPACE ENTRY**

---

Within the *OSHA Confined Space Regulations*, there are three categories for Confined Space Entry:

- **Standard Entry into a Permit Required Confined Space**

A permit required confined space is one that meets the definition of a confined space and contains or has the potential to contain a hazardous atmosphere, physical hazards, or biological hazards. These spaces have a higher risk associated with them that has the potential to exist even with controls in place. All the requirements of permit space entries apply such as the use of a Confined Space Permit, Attendant, Rescue Personnel, and extraction equipment.

Regional/ Business Unit Directors or assigned designate shall endorse (can be written, verbal, or electronic communication) the Confined Space Standard Entry plan.

- **Alternate Entry into a Permit Required Confined Space**

When the only hazard associated with an entry is actual or potential hazardous atmosphere that can be successfully controlled with mechanical ventilation, alternate procedures may be used. In this case, rescue personnel are not required. Authorized entrants will be required to vacate the space if a hazardous atmosphere develops. The confined space must not contain hazards due to one or more of the following:

- Materials or substances within the confined space
- Presence of a material (e.g., liquid, abrasive blasting materials) that pose an engulfment hazard
- Work activity that creates or has the potential to create a hazardous condition (e.g., painting, coating, welding, abrasive blasting, and pulling back tank seals) that the implemented hazard controls cannot address.
- Design, construction, internal configuration, or location such that a worker could become trapped.

\*Note: The OSHA Standard requires when there is "any other recognized serious safety and health hazard" as one of its hazard characteristics results in a confined space being classified as a permit space. The intention of this requirement is not to apply to the mere presence of non-specific hazards such as physical, biological, or other. The intent is when there is a hazard that is immediately dangerous to life or health or one that impairs the employee's ability to perform self-rescue, then alternate entry should not be utilized.

- **Entry into Non-Permit Required Confined Space**

A confined space is one that meets the definition of a confined space, but through the control of hazards does not meet the criteria of a permit required confined space. These



types of spaces do not have the ability to be reconfigured, where they are no longer a confined space. The hazards may be controlled through isolation, ventilation, or other means that eliminates actual and potential physical, chemical and biological hazards.

For this type of work, serious hazards and the potential for a hazardous atmosphere have been fully eliminated (without any further need for mechanical ventilation), allowing work to be conducted without a Confined Space Entry Permit. If a space is only temporarily being classified as a Non-Permit Required Confined Space (i.e., under normal conditions or certain conditions it would be a Permit Required Confined Space), the remediation work to reclassify and testing to establish it is no longer a Permit Required Confined Space need to be documented.

Note: Control of atmospheric hazards through forced air ventilation does not constitute elimination of the hazards.

### 6.4.2 CONFINED SPACE REQUIREMENTS

Requirement	NON-PERMIT REQUIRED CONFINED SPACE	PERMIT REQUIRED CONFINED SPACE Standard Procedure	PERMIT REQUIRED CONFINED SPACE Alternate Entry
<b>Confined Space Entry Permit</b>	Not Required	Required	Required
<b>Written Procedure / Entry Plan</b>	Follow site emergency response plan	Entry Plan Required *For predictable, routine entry, (e.g., pigging or installing vapor tools) an entry template procedure can be completed in lieu of an entry plan and rescue plan	Entry plan required. A confined space entry template or procedure can be completed in lieu of an entry plan and rescue plan.
<b>Safe Work Permit</b>	Only if the work activity requires one. Entry into a space on its own does not require a SWP.		
<b>FLHA</b>	Required		
<b>Atmospheric Monitoring</b>	Required		Required – Authorized entrants will be required to vacate the space if a hazardous atmosphere develops. •Oxygen levels that are below 19.5%, •LEL greater than 10%, •H <sub>2</sub> S greater than 10 ppm, •Carbon Monoxide levels greater than 25 ppm, •or Benzene levels greater than 0.5 ppm)
<b>Working Alone</b>	Working alone is allowed.	Working alone is not allowed	
<b>Ventilation</b>	As required to maintain acceptable criteria		
<b>Isolation and LOTO</b>	May be required depending on the work activities to be performed. If applicable complete appropriate process for isolation and LOTO per requirements.		
<b>PPE</b>	As required in the PPE Standard.	As required in the PPE Standard. SCBA / SABA/Escape Pack may	As required in the PPE Standard. Tank roof entry may require the usage of a SCBA / SABA/Escape Pack until the levels for the work

Requirement	NON-PERMIT REQUIRED CONFINED SPACE	PERMIT REQUIRED CONFINED SPACE Standard Procedure	PERMIT REQUIRED CONFINED SPACE Alternate Entry
		be required when the entire space cannot be verified prior to entry, then authorized entrants may switch to the level required by actual readings and/or site requirements	area are confirmed to be acceptable, then authorized entrants may switch to the level required by actual readings and/or site requirements.
<b>Rescue Plan</b>	Required. Options must be developed to address medical emergencies not related to confined space entry, e.g., a broken bone in the space. This is based on the assumption that there is not an actual or potential hazardous atmosphere. A facility emergency action plan can be used to meet this requirement.	Required  *For predictable, routine entry, (e.g., pigging or installing vapor tools) an entry template procedure can be completed in lieu of an entry plan and rescue plan	Required. Options must be developed to address medical emergencies not related to confined space entry, e.g., a broken bone in the space. This is based on the assumption that there is not an actual or potential hazardous atmosphere. A facility emergency action plan can be used to meet this requirement.
<b>Rescue Team</b>	Not Required	Required	Not required
<b>Rescue Equipment</b>	May be required depending on the rescue plan.	Required	May be required depending on the rescue plan.
<b>Confined Space Training</b>	Required		
<b>Additional Personnel Required</b>	None	Attendant Entry Supervisor Rescue Team	Attendant Entry Supervisor One person may fulfill both roles
<b>Pre-Job Entry Meeting</b>	None	Required	Required

### 6.4.3 TEMPORARY DECLASSIFIED SPACE

A temporary declassified confined space is one that started as a confined space, but through control of all actual or potential hazards no longer meets the definition of a confined space (e.g., no longer has limited means for entry and exit, etc.). An example of this would include a tank that has been degassed, cleaned, and has a door sheet removed. In this situation, the workers will still need to consider all applicable safety standards, e.g., Atmospheric Monitoring, PPE, Respiratory Protection, etc.

### 6.4.4 TRENCHES AND EXCAVATIONS

A trench or excavation is not considered a confined space. However, a confined space may exist within an excavation, e.g., entry into a pipe.

### 6.4.5 MINIMAL DEPTH WHISTLES/VERTICAL CULVERTS

Whistles / vertical culverts less than 2 feet (0.6 meters) in depth are not considered a confined space.

---

#### **6.4.6 SMALL PIPING**

Any piping with a diameter small enough that a person cannot bodily enter does not meet the definition of a confined space.

#### **6.4.7 EXTERNAL FLOATING TANK ROOFS**

Entries onto tank roofs may change in classification depending on the hazards. There are work task activities that do not pose the hazard of actual or potential hazardous atmospheres when appropriate controls are in place. Examples of this would include work on the tops of open floating roofs of tanks that do not include exposure to fresh or new product and does not have the potential to change the atmosphere due to the work activity (e.g. removing the plug from a roof drain, visual inspection of components, cold work, etc.). Tasks that allow exposure to product or cause changes to atmosphere must be treated as a permit required confined space entry (e.g. pulling back the secondary seal, opening a vacuum breaker, etc.)

When performing an alternate entry, employees should still consider other hazards such as slippery walking surfaces, ice and wind when planning work.

Controls for actual or potential atmosphere may be controlled through items that include, but are not limited to:

- Tank roof is static. The product and atmospheric conditions (e.g. wind, temperature, etc.) of the tank will need to be considered to determine if the atmospheric conditions have stabilized and the tank is safe for entry. The tank atmosphere will be confirmed with a monitor with appropriate PPE as required in the alternate procedures section.
- The Control Center Operations (CCO) is contacted
- Tank is isolated
- Tank does not have any known seal leaks
- Tank does not have any open vacuum breakers
- Tank roof does not have any new visible product on it
- Tank is at a high enough level to have natural ventilation (e.g., no vertical ladders)

In the event a tank roof entry does not have an actual or potential hazardous atmosphere, and the work activity being performed will not change the classification, the space may meet the definition of a non-permit required confined space. In the event a tank roof meets these criteria, alternate entry requirements will be used in lieu of non-permit confined space entry requirements. Mechanical ventilation would not be required for this work activity if data shows there is not a hazardous atmosphere and the potential has been removed through appropriate controls. Personnel must not enter under a floating roof unless it is secured by anti-rotational devices and

by supplemental support in the area that will be occupied. Exceptions must be approved by Regional Management.

Note: Walking on Aluminum geodesic dome roofs is strictly prohibited.

## **6.5 CONFINED SPACE ENTRY PLAN**

Before an employee is permitted to enter a confined space, the work group that is responsible for or conducts confined space operations must prepare and implement a written confined space entry plan which includes at a minimum:

- Information on the confined space (e.g., dimensions, hazards, controls, ventilation)
- Identification of work activity
- Verification of lockout and isolation if applicable
- Ventilation calculations if applicable
- Communication process (e.g., constant communication with authorized entrants, emergency warning system)
- Identify roles and responsibilities
- Required PPE, including the use of lifelines
- Rescue equipment
- Lockout and isolation, coordination of work activities.

## **6.6 PRE ENTRY MEETING**

The Entry Supervisor will conduct a pre entry meeting prior to entry with all involved workers as applicable:

- Worker(s) entering space
- Confined space attendant personnel
- Rescue personnel at a minimum when working in a permit required confined space
- Permit Issuer
- Site or Worker Supervisor(s) that may direct the work of any of the above

The pre entry meeting will cover the following before confined space entry as applicable:

- The confined space entry permit requirements
- Established procedures
- Air testing procedures

- Method of recording testing results
- Communication system
- Isolation of energy sources and control of materials movement
- Required PPE/respiratory protection equipment
- Securing the confined space from unauthorized entry
- Emergency equipment and required inspection of the equipment
- Ventilation requirements

In the event personnel are added to the Entry Team that did not attend the pre entry team meeting, the Entry Supervisor must review the contents of the meeting with this person and be satisfied they are fully briefed on their role and responsibilities in the entry activities.

The Entry Team should engage in cursory review of the contents of the Confined Space Package, with a primary focus on:

- Ensuring the stipulations set out in the confined space entry plan have been or will be met prior to entry, including
  - Pre-initial entry preparations such as isolation, lock out / tag out, and any cleaning, purging, or ventilation activities.
  - Controls to be applied during entry or work within the space.
- Ensuring familiarity with the procedure for initial and any subsequent entry under review.
- Review of the Rescue Plan and ensuring all members are clear on their roles.

All stipulated pre entry preparation activities must be complete and verified prior to entry.

For subsequent entries to conduct tasks within confined spaces, the size, scope, and necessity of an Entry Team meeting needs to be based on:

- The level of hazards within the space and introduced by the tasks to be conducted.
- The existing familiarity of entrants, confined space attendant, rescue, Entry Supervisor with the confined space and its hazards (e.g., are the same personnel involved as those attending the pre entry meeting?).
- At minimum, prior to any entry to complete a task, the Entry Supervisor must go over the confined space entry plan for the task at hand with the Entrants as part of the Safe Work Permit process (in lieu of a full Entry Team meeting).

## **6.7 CONFINED SPACE ENTRY PERMIT**

---

A worker shall not enter a permit required confined space without a valid confined space entry permit. Any site emergency, or if the criteria for entry to be terminated is met, shall force the stoppage of all work and will require a new permit to be authorized. The following requirements apply to the confined space entry permit:

- The permit is issued and authorized by permit issuer
- The permit is received by a qualified worker who is involved in the confined space entry
- The permit is approved by a qualified Enbridge employee or representative when a contractor is performing entry
- The permit must be signed by the issuer, receiver, and approver (if applicable)
- The permit cannot be issued until all required fields are completed, and all hazards have been identified and controlled
- If there are changes in the field, the permit will be revised and discussed with impacted parties
- Permits are valid for 12 hours or until the end of the shift, unless there is an approved extension. May be extended if:
  - The same authorized entrant is involved in the work
  - The extension is identified and authorized on the permit
  - A review of the permit confirms it is still valid

The permit must identify conditions to terminate entry.

The permit will be maintained / posted outside of the confined space with supporting documents as applicable.

A single permit may be utilized for multiple spaces when the hazards of the space and the work to be performed are similar.

In the event that an entry has been terminated (due to atmosphere or other unanticipated or unidentified conditions or hazards), this includes the permit being terminated, no entry will occur until the confined space hazard assessment is completed and / or updated and the space is deemed safe for entry.

### **6.7.1 CONFINED SPACE PERMIT ROLES**

Confined Space Permit Issuer shall:

- Determine Confined Space Classification
- Review hazards and controls with the Permit Receiver

- 
- Verify compliance with the requirements on the Confined Space Entry Permit
  - Verify that appropriate controls are in place
  - Ensure Initial Atmospheric Monitoring is complete
  - Ensure all confined space entry and regulatory requirements are met prior to issuing the confined space entry permit
  - Terminate the confined space entry and permit if conditions warrant termination

Note: This role is typically completed by the Entry Supervisor. The role can be filled by a qualified Enbridge employee or representative or contractor employee.

Confined Space Entry Permit Approver shall:

- Acknowledge the work
- Review Hazards and controls with the Permit Issuer
- Ensure the Confined Space Entry Permit Issuer is aware of site-specific information

Note: This role is intended for approval of contractor entries and is not required for employee entries. This role can only be filled by a qualified Enbridge Operations employee for entries by contractors hired by Operations. An Enbridge representative (e.g. Inspector) will fill this role for entries by contractors hired by other business units.

Confined Space Entry Permit Receiver shall:

- Provide the Permit Issuer with adequate notice of intended entry
- Provide a sufficient description of the scope of work
- Review hazards and controls with Workers involved in the work
- Ensure requirements on the permit are followed
- Attend and participate in the pre entry meeting
- Review hazards and control with permit issuer

Note: This role can be either an Enbridge employee or contractor who is involved with the entry to be performed

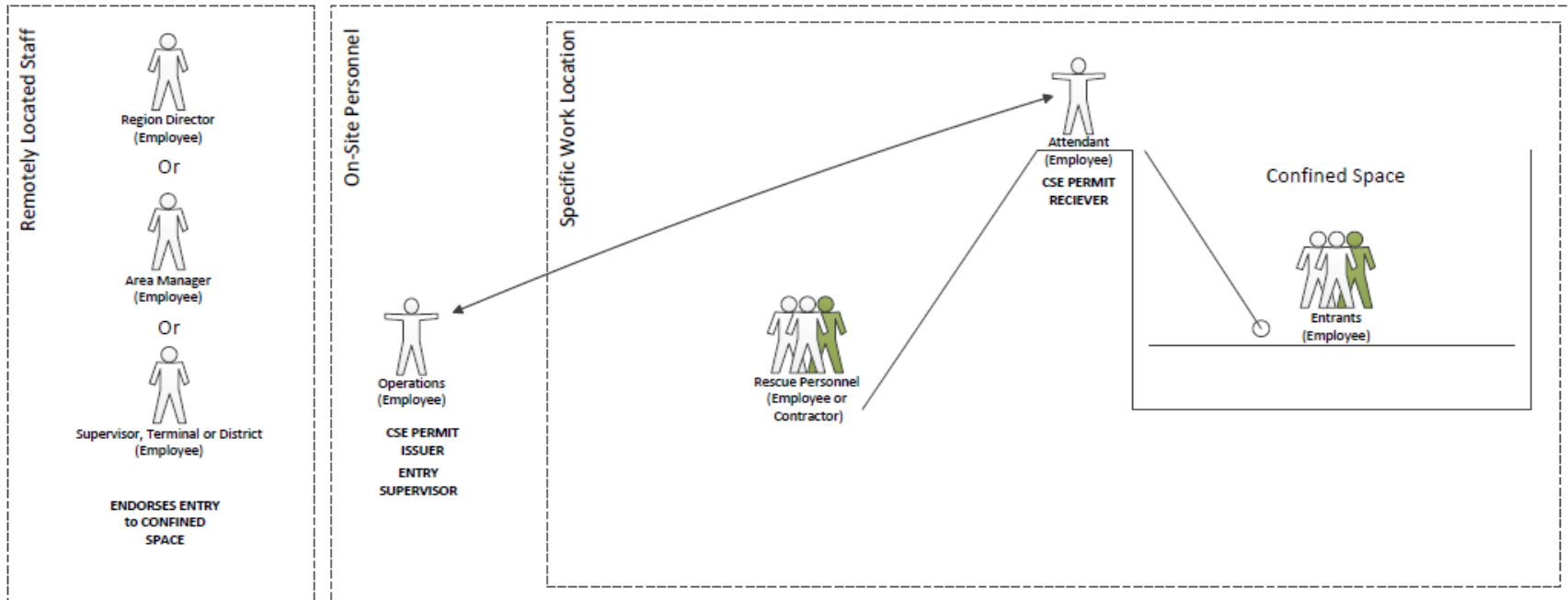

Employee Entry by Operations



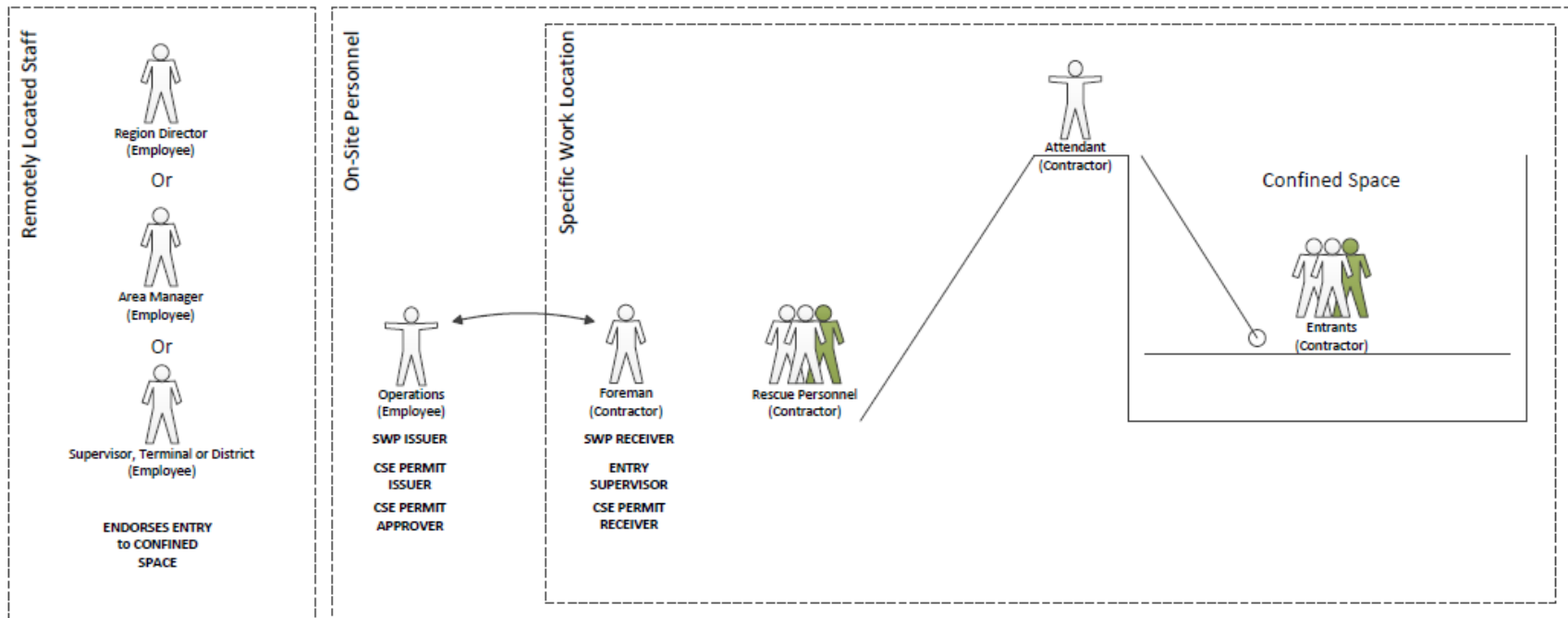

**Contractor Entry by Operations**

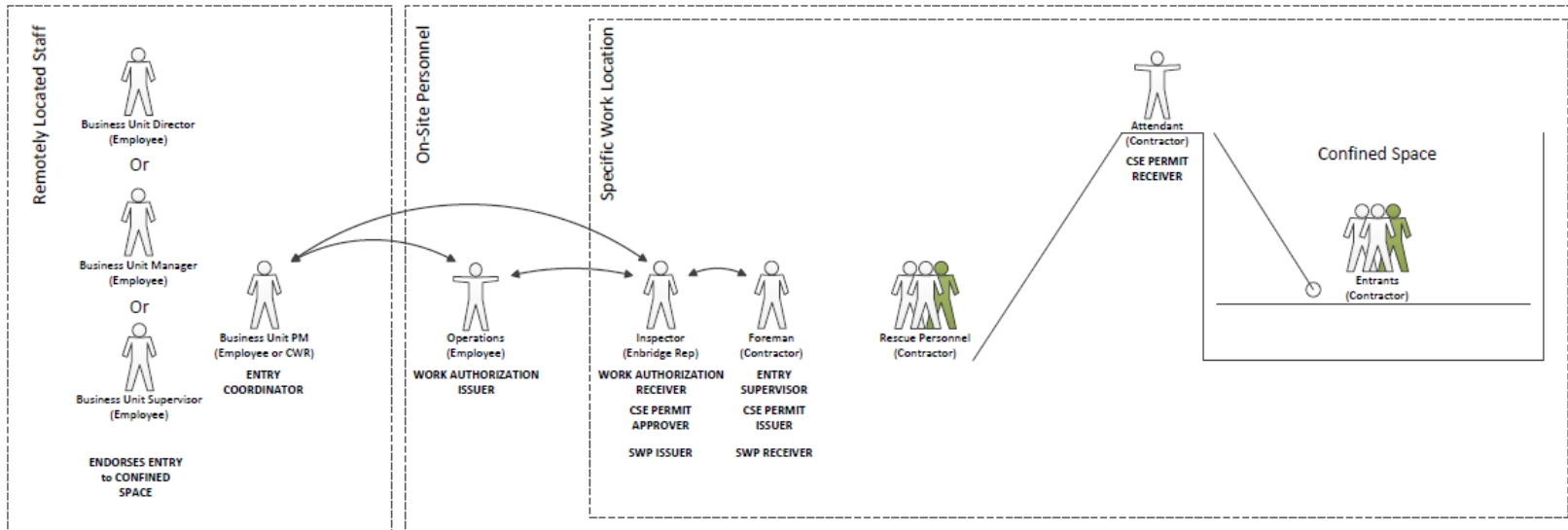

Contractor Entry by Non-Operations Business Unit

**6.7.2 TERMINATING AN ENTRY**

If atmospheric monitoring indicates that unplanned or unexplained changes have occurred in the confined space all work shall stop and workers will evacuate the confined space. The hazard assessment shall be reviewed if an entry has been terminated and updated as required.

The Entry Supervisor will document on the confined space permit atmospheric conditions of when a confined space entry will be terminated.

If the acceptable criteria cannot be maintained, the typical conditions to terminate an entry may include:

- Oxygen levels that are below 19.5%, or above 23.5%
- LEL of greater than 10% when conducting hot work
- LEL of greater than 20%
- When any contaminant is above the action level per legislative requirements
- Any injury
- Any abnormal operation
- Change to the scope of work
- Site emergency
- If requested to stop work

The time of termination shall be documented on the Confined Space Permit, as the case may be, by the Receiver. Suspended permits shall be revalidated, at a minimum, verbally by the Issuer and documented on the Confined Space Permit before work can resume.

Suspensions due to scope of work changes cannot be revalidated. A new Confined Space Permit is required.

**6.7.3 PERMIT DOCUMENT COPIES**

White/top copy: Permit Receiver keeps or posts this copy at the work location while the permit is valid. Permit Receiver returns this copy and other pertinent documentation to the Permit Issuer when the Permit time period has expired.

If an event occurs during the course of work, the white copy of the Permit along with all other documentation shall be forwarded to the person responsible for conducting the event analysis and will be retained as identified in the requirements for event analysis documentation.

Yellow copy: Permit Issuer maintains this copy to identify work activities occurring at the site. Discard after the white copy is returned.

In compliance with Enbridge’s Records Management Policy and Records Retention Schedule, Enbridge Employees must retain all Permits and any related documents or records. All required documentation applicable to Confined Space entry is developed, completed and maintained, in accordance with Enbridge requirements and Applicable Legislation.

Contractors shall have a records retention policy to ensure that all documents or records used, prepared or produced by the contractor in the performance of the work are maintained by the contractor for durations of time that are not less than the limitation periods prescribed in the applicable statutes of limitations or limitation of actions legislation in force in the jurisdictions the contractor operates.

## **6.8 WORK PRACTICES**

### **6.8.1 PREVENTING UNAUTHORIZED ENTRY**

Confined spaces must be:

- Secured against entry (e.g., bolted shut or locked), or
- Identified by a sign that states “Danger, Confined Space, Entry by Permit Only” or a sign that uses similar wording at the entry point to indicate that this is a Confined Space and that entry is not permitted without a permit.
- When there is a confined space attendant present at an open confined space, the attendant must ensure all entrants are authorized for entry into the confined space.

Signage that has been removed to allow entry into the confined space shall be replaced when the space has been left unoccupied, this includes breaks and shift change.

### **6.8.2 ATMOSPHERIC TESTING/MONITORING**

Refer to the Atmospheric Monitoring and Respiratory Protection Standards for additional information on confined space atmospheric monitoring and sampling.

Atmospheric monitoring for hazards shall:

- Be conducted by a qualified person using calibrated test instruments that are appropriate for the atmosphere being tested and used in accordance with manufacturers’ specifications
- Be completed in accordance with the requirements identified on the hazard assessment
- Be performed in a manner that does not endanger the health or safety of the worker performing the test
- Be performed in the following order:
  1. Oxygen content (% O<sub>2</sub>)
  2. Flammable gases/vapors (% LEL)
  3. Toxic air contaminants (e.g., H<sub>2</sub>S)

4. Other toxic contaminants associated with the work environment, work activity and related job tasks (e.g., CO, Benzene)

**Initial Atmospheric Monitoring**

Initial atmospheric monitoring is required prior to entry into any confined space, and before a worker re-enters a confined space that has been unoccupied for any length of time. Initial testing must be performed no more than 20 minutes prior to an entry. Atmospheric testing must be repeated within 20 minutes of entry if a confined space is vacated for more than 20 minutes.

Initial monitoring shall be completed from outside the space utilizing remote gas detector accessories and equipment such as sample draw pumps and wands whenever possible. Testing from outside the confined space is not considered entry and does not require a permit. If initial atmospheric monitoring cannot be completed from outside the confined space, conduct initial testing under the respiratory protection level based on the conditions at the time. If this cannot be determined or adequately assessed, wear SCBA / SABA respiratory protection.

Large spaces that are difficult to assess from outside the space can be assessed gradually. If the levels are below hazardous at the entrance, the individual performing the testing can then proceed further into the space. This would continue until a hazardous atmosphere is detected or the space has been fully evaluated. If a hazardous atmosphere is detected, the individual performing the testing will exit the space and discuss entry options with the Entry Supervisor.

If a space has or has the potential for an IDLH atmosphere, a rescue team must be in place prior to the initial atmospheric monitoring being completed (e.g. testing in a tank roof pontoon).

Complete atmospheric monitoring at various locations and elevations of the space whenever possible. Refer to the Atmospheric Testing Standard and the manufacturer's recommendations when performing atmospheric monitoring. Also, consider the response times, length of hose, attachments, functionality of monitor etc.

**Continuous/Periodic Monitoring**

Continuous atmospheric monitoring for the following is required anytime a worker is in a confined space:

- Oxygen (% O<sub>2</sub>)
- Lower explosive limit (% LEL)
- Hydrogen sulfide (H<sub>2</sub>S)
- Carbon monoxide (CO)

Levels are documented on the confined space entry permit at a frequency determined by the Entry Supervisor.

Periodic atmospheric monitoring and atmospheric sampling may be required for other hazards or contaminants (e.g. benzene). These frequencies shall be determined by the Entry Supervisor and documented on the confined space entry permit. Frequency for testing may vary from minutes to hours, depending on the hazards of the space.

The use of a Personal Monitor when working in a confined space shall be in accordance with the requirements of the Atmospheric Monitoring Standard.

**6.8.3 IDLH ATMOSPHERE**

Planned work shall not take place in IDLH environments. If an IDLH environment exists, or has potential to exist, then work shall stop until controls are in place to eliminate, control or minimize the hazards to an acceptable level. Refer to the Immediately Dangerous to Life and Health Atmospheres Procedure for process for working in an IDLH atmosphere.

**6.8.4 INERTING**

A confined space may be inerted if it is not reasonably practicable to eliminate an explosive or flammable atmosphere through other means. Inerted confined spaces will be treated as permit required (high hazard) due to the removal of oxygen. If a confined space is inerted, ensure that:

- Every worker entering the confined space is equipped with SCBA / SABA respiratory protection equipment until oxygen levels have returned to normal.
- All ignition sources are controlled
- The atmosphere within the confined space stays inerted while workers are inside.

Note: notification to regulatory bodies may be required when placing workers in an inert atmosphere per local legislative requirements

**6.8.5 VENTILATION REQUIREMENTS**

If atmospheric hazards exist or are likely to exist in a confined space, the confined space shall be purged or ventilated, or both, before any worker enters the space. Acceptable atmospheric levels, as identified on the confined space entry permit, shall be maintained at all times when worker(s) are present in a confined space.

Ventilation requirements shall be determined prior to the entry of the confined space, or utilized if levels are not acceptable. If testing indicates that the confined space’s atmosphere is explosive, or if assessment determines that an explosive atmosphere is likely to develop, then purging of the space with an inert gas shall be performed prior to ventilation. Using air movers as a means of ventilation may create a hazardous, explosive atmosphere, due to the addition of oxygen into the confined space.

If ventilation and/or purging are not practical to maintain acceptable atmospheric levels in a confined space, the workers involved shall wear respiratory protection equipment in accordance with the Respiratory Protection Standard.

If mechanical ventilation is required to maintain a safe atmosphere in a confined space, the ventilation equipment shall be equipped with an alarm that will be activated automatically if the equipment fails. An adequate warning system of ventilation failure shall be in place, to ensure each worker receives each warning and is able to exit the confined space safely.

The mechanical ventilation equipment shall be audible or visible to every worker in the confined space, or monitored by a worker who is in constant attendance at the equipment and who is in communication with the authorized entrants. Should the ventilation equipment fail to operate properly, this worker shall immediately direct the authorized entrants to evacuate.

Air volume for confined spaces shall meet the following criteria, if applicable:

- Minimum volume of 1.9 m<sup>3</sup>/s of air passes through the active working area; or
- Air in the confined space contains at least 19.5% oxygen by volume, LEL is below 10%, and the concentration of each hazardous substance or contaminant(s) present in the space's atmosphere is below acceptable criteria outlined in the permit (below all exposure limits in most cases); or
- The confined space has an air exchange rate of at least 8 times/hour; or
- Per a consensus standard accepted by industry (e.g., API, ANSI, CEPA)

Proper set-up of a ventilation system for a confined space is critical to ensure its effectiveness and to minimize/control hazards and exposures. Consider the following:

- Eliminate “short-circuiting” of airflow around the fans or blowers by using an adaptor plate to bolt the fan to the flange of a man-way, or use any other safely feasible measure.
- Supply air needs to be ducted/hosed to deliver it to the work zone and exhaust air needs to be able to capture any contaminants that may be generated by work activities. The exhaust hood or duct should be placed 300 mm (1 ft.) from the source of the contaminant(s).
- A combination of pushing air in and pulling air out of the confined space is often the most effective. If a contaminant is heavier than air (e.g., crude oil vapors), the ventilation strategy should be to push air in from the top and channel exhaust air out from the bottom. However, if the contaminant is lighter than air (e.g., methane), the contaminant has a tendency to rise to the top of the space, the ventilation strategy should be to push air in from the bottom and pull air out from the top.
- Ventilation should be continuous, where possible, if the source(s) of the hazardous atmosphere still exists, or if operations in the confined space generate contaminants or hazards that create a hazardous atmosphere.
- When a confined space has only a single man-way or opening, or has interior obstructions that decrease the effectiveness of dilution ventilation, local exhaust ventilation with a capture hood/duct placed at the source of contaminants is recommended.

- Confined spaces containing flammable gases or vapors may need to be purged with an inert gas prior to ventilating with air. If inert gases (e.g. nitrogen, argon, carbon dioxide) are used for inerting the confined space, the space shall be well-ventilated after the inerting is completed. Then the atmosphere shall be re-tested before any authorized entrant enters the space.
- Where flammable or combustible gases may be present, the ventilation equipment used shall be designed for use in such environments. The equipment shall also be properly grounded and bonded to prevent static electricity from potentially igniting a combustible source.
- Ensure venting activities do not create another hazard. For example, scrubbers may be applied to the venting exhaust to prevent buildup of contaminant in another location.
- If the location has an air permit, the release of emissions must not violate air permitting requirements. Refer to the Environment Department for further clarification.
- Ensure the make-up (fresh) air for the confined space is free of contaminants. Note that make-up air could be contaminated by:
  - Exhaust air that carries contaminants from work that is carried out within the confined space
  - Exhaust from nearby or adjacent fuel-operated equipment, such as generators, air compressors, vacuum trucks, or other vehicles
  - Vapors or substances arising from nearby or adjacent operations and processes, e.g., organic vapors from painting, silica from blasting operations, or lead from paint removal work

### **6.8.6 HOT WORK**

Unless a qualified person has determined that work can be performed safely, hot work shall not be performed in a confined space that contains:

- an explosive or flammable hazardous substance in a concentration in excess of 10% of its lower explosive limit; or
- oxygen in a concentration in excess of 23.5%

If these conditions are exceeded during hot work activities, the hot work shall stop and remain stopped until the conditions are deemed safe for work to continue. This determination shall be based on additional or subsequent air testing.

When performing hot work activities, a qualified fire watch person shall patrol the area surrounding the confined space until all fire hazards have passed per the Hot Work and Ignition Sources Standard. Appropriately rated fire extinguishers are required in the immediate area per the Emergency Preparedness Standard.



### **6.8.7 ISOLATION REQUIREMENTS**

Refer to the Control of Hazardous Energy Standard for additional information on isolation and control of energy. Each worker entering a confined space shall be adequately protected against isolation related hazards, as follows:

- Protect workers from the release of hazardous substances in the confined space by disconnecting, blanking, blinding or double block and bleed of piping, cribbing etc.
- Protect workers from contact with electrical energy inside the confined space by disconnecting, de-energizing, lockout and tagging the source of electrical energy.
- Protect workers from moving parts of equipment inside the confined space by disconnecting the equipment from its power source, de-energizing the equipment, ensuring there is no stored energy, locking and tagging all energy sources.
- Other adequate means of worker protection and hazard prevention are required if the above controls are not possible.

### **6.9 CONFINED SPACE RESCUE**

The rescue requirements for each permit required confined space will vary based on the unique hazards identified. Every permit required confined space entry requires:

- The services of one or more rescue personnel
- A documented Rescue Plan
- Personnel assigned rescue duties must be notified before workers enter a confined space and when all workers have exited from the space.
- If multiple confined spaces are being entered, notifying rescue personnel to be onsite in an alert status, unless the confined space(s) pose a risk of IDLH Atmosphere.
- In cases where there is a contract for rescue personnel to provide 24-hour service individual notification may not be required.
- Assigned rescue personnel must monitor any signaling system used to summon them while a confined space entry is underway or while on an alert status.
- Where an entry-rescue into IDLH atmosphere is a possible rescue scenario, the rescue team must remain at the confined space during the entry itself. The rescue team must have PPE donned, including SCBA or SABA with an escape bottle, and respirator masks at the ready.
- Where an entry-rescue into an actual or potential IDLH atmosphere is a possible rescue scenario, the rescue team must identify an appropriate number of responders based on OSHA requirements for IDLH atmospheres in Confined Space and Respiratory Protection

- A rescue worker may not enter the confined space unless there is at least one additional worker located outside to render assistance.
- The confined space attendant may serve as a rescue worker and may perform a non-entry rescue using an attached lifeline.
- In the event rescuing an entrant involves physically entering the confined space, a rescue worker in addition to an existing confined space attendant will be required to execute a rescue (i.e., one person enters to extract the entrant, the other remains outside to render assistance).
- Once rescue is initiated, the People Leader on the scene is either (a) an Entry Supervisor with knowledge of the rescue procedure or (b) a qualified rescue worker.
- The most senior person present, not directly involved in the rescue shall trigger the site-specific Emergency Response Plan.
- The qualified confined space rescue team retains control over the rescue itself until the entrant is extracted.
- Rescue personnel must wear SCBA or SABA with an escape bottle in any rescue within a confined space with an unknown or IDLH atmosphere.
- Workers entering a space assessed as a “permit required confined space” must wear a safety harness securely attached to a lifeline.
- The lifeline must be securely anchored outside the confined space.
- The confined space attendant is responsible to assist in ensuring the lifeline does not become entangled during entry and work inside.
- The confined space attendant must be able to extract the worker(s) without entering the space using the lifeline in an emergency and must be supplied with a mechanic device as required to facilitate this type of rescue.
- This requirement does not apply if the lifeline itself creates a hazard or extraction with the lifeline would be impossible due to the configuration of the space.
- Frequency and requirements to complete drills as outlined by Regulatory Requirements.

### **6.9.1 INTERNAL RESCUE TEAMS**

Internal rescue teams are allowed if workers are trained (see training requirement below) and have appropriate equipment on site. A facility will be required to complete a hazard assessment if utilizing an internal rescue team to determine the hazards of the spaces entered, controls, and appropriate rescue equipment is appropriate for the spaces that an internal team will be utilized.

Equipment utilized for confined space entry must be inspected and maintained per manufacturer’s specifications.

Per OSHA requirements, internal rescue teams will be required to practice making permit required confined space rescues at least once every 12 months.

**6.9.2 THIRD PARTY RESCUE TEAMS**

If a facility will be utilizing a third party rescue team, the following requirements will apply.

Evaluation

An evaluation of the rescue team must be completed by the hiring business unit a minimum of once per a calendar year. This information only needs to be completed by one business unit/Region and then can be shared with other units/Regions utilizing the same vendor. Information reviewed will include at a minimum:

- Deployment history
- Type of work provided
- Availability and staffing
- Training records
- Equipment inventory
- Equipment maintenance and inspection procedures

Coordination of Work

The hiring business unit must provide the rescue team with access to all spaces from which rescue may be necessary. This is to facilitate that the rescue service can develop appropriate rescue plans and practice rescue operations.

Equipment

The selection of equipment must be appropriate for the confined space. All rescue equipment must be appropriately rated for its use (recommended utilizing equipment rated as NFPA 1983). Equipment must have inspections documented and available for review.

Rescue Plan

The confined space rescue team will be required to develop and submit for review a rescue plan for the work being completed, consistent with 6.9.3.

If an area is utilizing a fire department in any capacity for a confined space rescue, it must be confirmed that the fire department has the ability and appropriate equipment to assist. The requirements for third party rescue apply in an application where a fire department will be utilized. The fire department will also be granted access on a regular basis to review and evaluate spaces.

### **6.9.3 RESCUE PLAN**

Confined spaces classified as permit required must have a formal rescue plan developed prior to space entry and maintained with other confined space entry documents. This plan should be read and reviewed prior to initial entry by the Entry Team to:

- Ensure familiarity with the plan for all participants (entrants, confined space attendant, and rescue team) with the plan.
- Determine if any additional rescue provisions need to be prepared.

Note: A single rescue plan may be applicable to several confined spaces that share similar characteristics and hazards.

The Rescue Plan must include at a minimum:

- Information on the confined space
  - Hazards – Potential and Actual
  - Controls
  - Site Layout
- Equipment necessary to complete a rescue
- Methodology of rescue
- Names of individuals that will be onsite performing the rescue
- Role each team member will perform in a rescue situation
- Contact information
- Communication methodology
- Medical equipment necessary to be on site
- PPE requirements

### **6.10 CONFINED SPACE CLOSURE REQUIREMENTS**

Once work is completed within a confined space, prior to final closure of the space, the following should be done:

- Final visual inspections to ensure no personnel are inside the space prior to closure.
- Ensure any active Permit is formally closed with required sign-offs complete.

### **6.11 CONFINED SPACE PACKAGE**

When a contractor will be conducting confined space entries, this package will be provided to them from an Enbridge representative all relevant documentation will be compiled and available prior to entry into a confined space. This Confined Space Package should include (as applicable):

- Worksite specific Confined Space Entry requirements
- Any specific identified Hazards as well as experience with the space, such as knowledge of hazardous conditions
- Applicable Safety Data Sheets
- Confined Space Permit
- Hazard Assessment
- Piping and Instrumentation Diagrams (P&IDs)
- Isolation drawings (identify isolation points, line breaks and blind locations)
- LOTO form(s)
- Procedures for tasks to be conducted in Confined Space (e.g., Operations & Maintenance Manuals (OMMs))

## **7.0 TRAINING**

Need to complete a needs analysis to understand if training is required. This will be done after the MOC process has been completed and the standard is approved.

Personnel who may be required to enter into a confined space or perform confined space entry must be knowledgeable in this standard and may be assigned applicable training as driven by the Safety Training Matrix.

Reference the Health & Safety training syllabi and matrices for further information and training re-certification requirements.

---

## **8.0 RELATED DOCUMENTS**

Atmospheric Monitoring Standard  
Emergency Preparedness – Personal Safety Standard  
Fall Protection Standard  
Hazard Assessment & Elimination Standard  
Hot Work & Ignition Sources Standard  
Immediately Dangerous to Life and Health Atmospheres Procedure  
Personal Protective Equipment Standard  
Respiratory Protection Standard  
Safe Work Permit & Work Authorization

## **9.0 STANDARD REVIEW**

A subject matter expert (SME) will perform a technical review of this standard annually to determine the accuracy of the content/information. The SME shall solicit input from applicable stakeholders to ensure the effectiveness of the standard. Any suggested changes must be reviewed and approved by the designated document owner.

## **10.0 REFERENCES**

OSHA 29 CFR 1910.146  
US Department of Transportation Pipeline and Hazardous Materials Safety Administration  
Information 49 CFR 195

## 11.0 APPENDIX

### 11.1 IDENTIFICATION OF A CONFINED SPACE

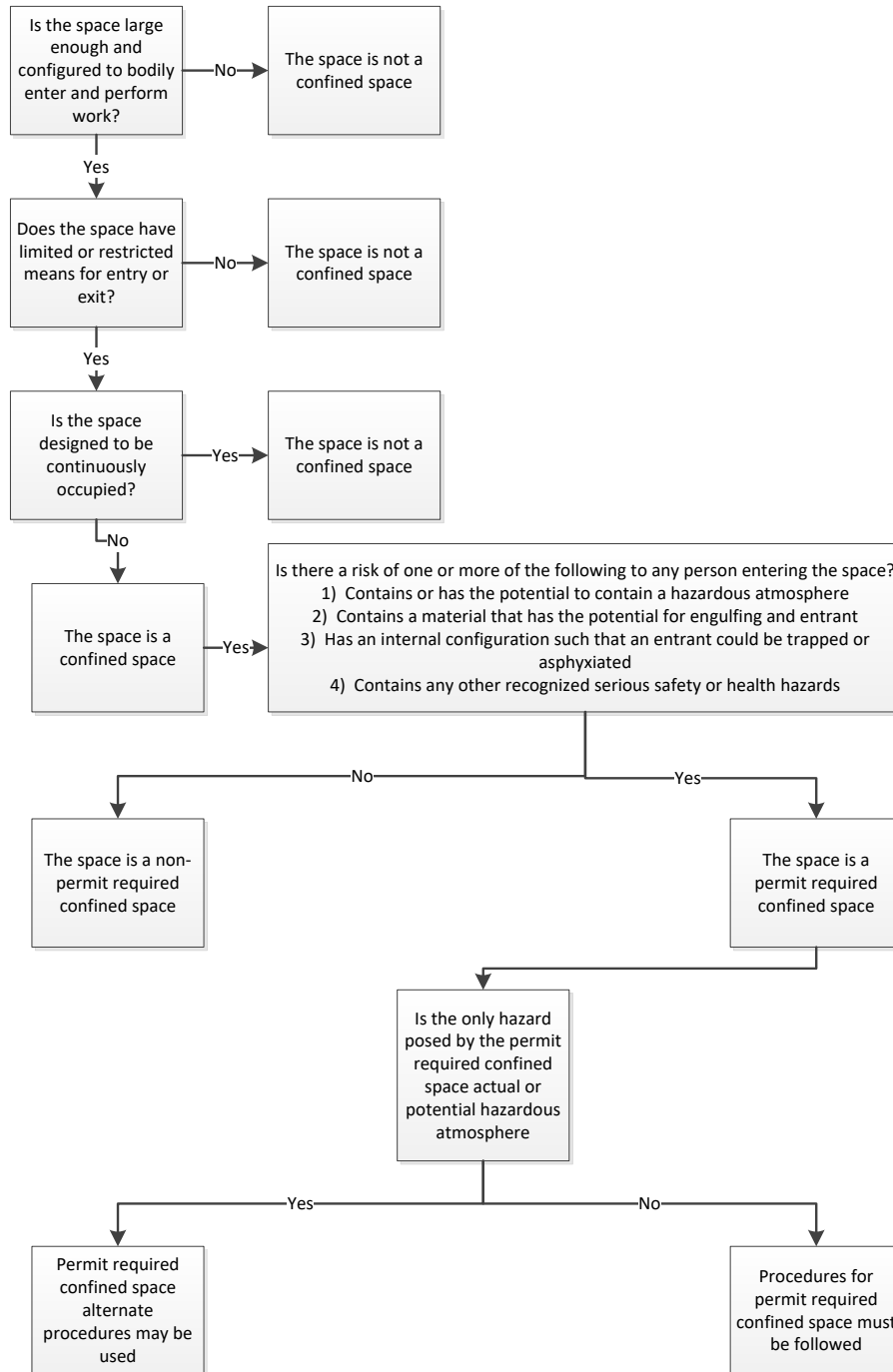



11.2 CONFINED SPACE ENTRY PERMIT

CONFINED SPACE ENTRY PERMIT – US

000000

Part 1: Description	Date Permit Issued: _____ Contractor: _____ Site: _____ Time Permit Issued: _____ Time Permit Expires (12 hour max without extension): _____ Time Work Completed: _____ Emergency Response Contact Info (e.g. phone #, radio channel): _____ Location of Confined Space to be Entered: _____ SWP #: _____ Is there an Isolation LOTO Form: <input type="checkbox"/> Yes <input type="checkbox"/> No If yes, attach. Other: _____									
Part 2: Confined Space Entry Checklist	<table border="1" style="width: 100%; border-collapse: collapse;"> <tr> <td style="width: 33%;"> <b>Type of Work:</b>  <input type="checkbox"/> Cold  <input type="checkbox"/> Hot  <input type="checkbox"/> Electrical – line side of 480v/600v main breaker (clearance/isolation form required)                 </td> <td style="width: 33%;"> <b>Work Environment:</b>  <input type="checkbox"/> Hazardous Area  <input type="checkbox"/> Restricted Area  <input type="checkbox"/> Unclassified                 </td> <td style="width: 33%;"> <b>Confined Space Class:</b>  <input type="checkbox"/> Permit Required Confined Space  <input type="checkbox"/> Alternative Entry                 </td> </tr> </table> Description of Work: _____ _____ _____	<b>Type of Work:</b> <input type="checkbox"/> Cold <input type="checkbox"/> Hot <input type="checkbox"/> Electrical – line side of 480v/600v main breaker (clearance/isolation form required)	<b>Work Environment:</b> <input type="checkbox"/> Hazardous Area <input type="checkbox"/> Restricted Area <input type="checkbox"/> Unclassified	<b>Confined Space Class:</b> <input type="checkbox"/> Permit Required Confined Space <input type="checkbox"/> Alternative Entry						
<b>Type of Work:</b> <input type="checkbox"/> Cold <input type="checkbox"/> Hot <input type="checkbox"/> Electrical – line side of 480v/600v main breaker (clearance/isolation form required)	<b>Work Environment:</b> <input type="checkbox"/> Hazardous Area <input type="checkbox"/> Restricted Area <input type="checkbox"/> Unclassified	<b>Confined Space Class:</b> <input type="checkbox"/> Permit Required Confined Space <input type="checkbox"/> Alternative Entry								
Part 3: Air Testing Requirements	<table border="1" style="width: 100%; border-collapse: collapse;"> <tr> <td style="width: 50%;"> <ul style="list-style-type: none"> <li>• Has the confined space location, hazards, and their controls, been reviewed and the confined space to be entered confirmed? <input type="checkbox"/> Yes <input type="checkbox"/> No</li> <li>• Has the hazard assessment been attached to the Permit? <input type="checkbox"/> Yes <input type="checkbox"/> No</li> <li>• Have all specific job responsibilities been assigned? (indicate person responsible):                      Entry Supervisor – _____                      Equipment Lockout – _____                      Attendant – _____                      Atmospheric Testing – _____</li> </ul>                 Preparation requirements completed prior to entry (cleaning, purging, venting, inerting, etc.): _____                  _____                  _____             </td> <td style="width: 50%;"> <ul style="list-style-type: none"> <li>• Have all entry points into the confined space been identified and properly secured against unauthorized entry? <input type="checkbox"/> Yes <input type="checkbox"/> No</li> <li>• Is required monitoring equipment available and calibrated? <input type="checkbox"/> Yes <input type="checkbox"/> No</li> <li>• Is required rescue equipment available? <input type="checkbox"/> Yes <input type="checkbox"/> No</li> <li>• Do all personnel have required training? (Including those not entering confined space) <input type="checkbox"/> Yes <input type="checkbox"/> No</li> <li>• Are all pertinent SDS available and have they been reviewed? <input type="checkbox"/> Yes <input type="checkbox"/> No</li> <li>• Are there any ventilation / equipment required? (i.e. air movers, nitrogen purge, etc.) <input type="checkbox"/> Yes <input type="checkbox"/> No</li> <li>• Have lockout and isolation points been verified and tested? <input type="checkbox"/> Yes <input type="checkbox"/> No</li> <li>• Have all required information and materials been provided to the contractor performing the confined space entry (if applicable): <input type="checkbox"/> Yes <input type="checkbox"/> No</li> </ul>                 Attachments:  <input type="checkbox"/> Hazard Assessment <input type="checkbox"/> Rescue Plan <input type="checkbox"/> SDS <input type="checkbox"/> Ventilation Plan (as required)  <input type="checkbox"/> Other: _____             </td> </tr> </table> Conditions Under Which Entry is to be Terminated: _____ _____ _____	<ul style="list-style-type: none"> <li>• Has the confined space location, hazards, and their controls, been reviewed and the confined space to be entered confirmed? <input type="checkbox"/> Yes <input type="checkbox"/> No</li> <li>• Has the hazard assessment been attached to the Permit? <input type="checkbox"/> Yes <input type="checkbox"/> No</li> <li>• Have all specific job responsibilities been assigned? (indicate person responsible):                      Entry Supervisor – _____                      Equipment Lockout – _____                      Attendant – _____                      Atmospheric Testing – _____</li> </ul> Preparation requirements completed prior to entry (cleaning, purging, venting, inerting, etc.): _____ _____ _____	<ul style="list-style-type: none"> <li>• Have all entry points into the confined space been identified and properly secured against unauthorized entry? <input type="checkbox"/> Yes <input type="checkbox"/> No</li> <li>• Is required monitoring equipment available and calibrated? <input type="checkbox"/> Yes <input type="checkbox"/> No</li> <li>• Is required rescue equipment available? <input type="checkbox"/> Yes <input type="checkbox"/> No</li> <li>• Do all personnel have required training? (Including those not entering confined space) <input type="checkbox"/> Yes <input type="checkbox"/> No</li> <li>• Are all pertinent SDS available and have they been reviewed? <input type="checkbox"/> Yes <input type="checkbox"/> No</li> <li>• Are there any ventilation / equipment required? (i.e. air movers, nitrogen purge, etc.) <input type="checkbox"/> Yes <input type="checkbox"/> No</li> <li>• Have lockout and isolation points been verified and tested? <input type="checkbox"/> Yes <input type="checkbox"/> No</li> <li>• Have all required information and materials been provided to the contractor performing the confined space entry (if applicable): <input type="checkbox"/> Yes <input type="checkbox"/> No</li> </ul> Attachments: <input type="checkbox"/> Hazard Assessment <input type="checkbox"/> Rescue Plan <input type="checkbox"/> SDS <input type="checkbox"/> Ventilation Plan (as required) <input type="checkbox"/> Other: _____							
<ul style="list-style-type: none"> <li>• Has the confined space location, hazards, and their controls, been reviewed and the confined space to be entered confirmed? <input type="checkbox"/> Yes <input type="checkbox"/> No</li> <li>• Has the hazard assessment been attached to the Permit? <input type="checkbox"/> Yes <input type="checkbox"/> No</li> <li>• Have all specific job responsibilities been assigned? (indicate person responsible):                      Entry Supervisor – _____                      Equipment Lockout – _____                      Attendant – _____                      Atmospheric Testing – _____</li> </ul> Preparation requirements completed prior to entry (cleaning, purging, venting, inerting, etc.): _____ _____ _____	<ul style="list-style-type: none"> <li>• Have all entry points into the confined space been identified and properly secured against unauthorized entry? <input type="checkbox"/> Yes <input type="checkbox"/> No</li> <li>• Is required monitoring equipment available and calibrated? <input type="checkbox"/> Yes <input type="checkbox"/> No</li> <li>• Is required rescue equipment available? <input type="checkbox"/> Yes <input type="checkbox"/> No</li> <li>• Do all personnel have required training? (Including those not entering confined space) <input type="checkbox"/> Yes <input type="checkbox"/> No</li> <li>• Are all pertinent SDS available and have they been reviewed? <input type="checkbox"/> Yes <input type="checkbox"/> No</li> <li>• Are there any ventilation / equipment required? (i.e. air movers, nitrogen purge, etc.) <input type="checkbox"/> Yes <input type="checkbox"/> No</li> <li>• Have lockout and isolation points been verified and tested? <input type="checkbox"/> Yes <input type="checkbox"/> No</li> <li>• Have all required information and materials been provided to the contractor performing the confined space entry (if applicable): <input type="checkbox"/> Yes <input type="checkbox"/> No</li> </ul> Attachments: <input type="checkbox"/> Hazard Assessment <input type="checkbox"/> Rescue Plan <input type="checkbox"/> SDS <input type="checkbox"/> Ventilation Plan (as required) <input type="checkbox"/> Other: _____									
Part 4: Onsite Evacuation & Rescue	Tester's Name: _____ Testing Equipment/ Methods: _____ Calibration Date: _____ Bump Date: _____ Frequency of Atmospheric Testing (results must be recorded at the interval): _____ Personal Monitors Required for Entrants? <input type="checkbox"/> Yes <input type="checkbox"/> No <input type="checkbox"/> Continuous for O <sub>2</sub> , LEL, H <sub>2</sub> S, CO (mandatory) <input type="checkbox"/> Other toxins to be tested: _____ Frequency of testing: _____ _____ Frequency of testing: _____ _____ Frequency of testing: _____ Acceptable atmospheric levels for this space (O <sub>2</sub> , LEL, H <sub>2</sub> S, CO, benzene, etc): _____ _____ _____ <b>Reminder:</b> Tests shall be performed and recorded before a worker enters or re-enters the space. Initial testing must be performed no more than 20 minutes prior to an entry. Atmospheric testing must be repeated within 20 minutes of entry if a confined space is vacated for more than 20 minutes.									
Part 5: Approvals	Are we using an internal Enbridge team for rescue? <input type="checkbox"/> Yes <input type="checkbox"/> No External Third Party Rescue: <input type="checkbox"/> Yes <input type="checkbox"/> No If yes, name of external vendor: _____ How is the rescue team summoned or communicated with (cellphone / radio, etc.) : _____ Equipment required for rescue: _____ Nearest Medical Facility: _____ Names of Rescue Team Members: _____ _____ _____ For permit required confined spaces, please attach the Rescue Plan. Work cannot begin until the required signatures are on this document. All persons performing this work must comply with Enbridge safety policies and government regulations. Work must stop should conditions change/lowe hazards appear or an emergency occurs on the site.									
Part 6: Signatures	<table border="1" style="width: 100%; border-collapse: collapse;"> <tr> <td style="width: 33%;">Permit Issuer/Entry Supervisor:</td> <td style="width: 33%;">Permit Approver</td> <td style="width: 33%;">Permit Receiver</td> </tr> <tr> <td>Print Name:</td> <td>Print Name:</td> <td>Print Name:</td> </tr> <tr> <td>Signature:</td> <td>Signature:</td> <td>Signature:</td> </tr> </table> By signing this permit, the receiver acknowledges that all safety requirements have been met, have been reviewed with the workers, will be maintained for the duration of the permit and it is safe to proceed with the work. All workers associated with the work must sign in the area provided on the back of the permit during the prejob entry meeting.	Permit Issuer/Entry Supervisor:	Permit Approver	Permit Receiver	Print Name:	Print Name:	Print Name:	Signature:	Signature:	Signature:
Permit Issuer/Entry Supervisor:	Permit Approver	Permit Receiver								
Print Name:	Print Name:	Print Name:								
Signature:	Signature:	Signature:								
Part 7: Record of Permit Closure	Record of Permit Closure: Job Completed? <input type="checkbox"/> Yes <input type="checkbox"/> No Have all personnel vacated the space? <input type="checkbox"/> Yes <input type="checkbox"/> No Have all tools/equipment been removed from the space? <input type="checkbox"/> Yes <input type="checkbox"/> No Permit Extension: Is the planned work expected to exceed 12 hours?									

VERSION 1 (March 30, 2019)

Distribution: White – Permit Receiver, Gold – Permit Issuer Retain white copy





**CONFINED SPACE ENTRY PERMIT – US**

**000000**

Part 6: Pre-Entry Meeting:																																
Confined Space Entry Supervisor or Designate (print and sign): _____ <small>This signature authorizes the entry of the following workers into the confined space.</small>																																
<table border="1" style="width:100%; border-collapse: collapse;"> <thead> <tr> <th colspan="3" style="text-align: left; padding: 2px;">Workers Involved (print and sign)</th> </tr> </thead> <tbody> <tr><td style="width:33%; padding: 2px;">1. _____</td><td style="width:33%; padding: 2px;">8. _____</td><td style="width:33%; padding: 2px;">15. _____</td></tr> <tr><td style="padding: 2px;">2. _____</td><td style="padding: 2px;">9. _____</td><td style="padding: 2px;">16. _____</td></tr> <tr><td style="padding: 2px;">3. _____</td><td style="padding: 2px;">10. _____</td><td style="padding: 2px;">17. _____</td></tr> <tr><td style="padding: 2px;">4. _____</td><td style="padding: 2px;">11. _____</td><td style="padding: 2px;">18. _____</td></tr> <tr><td style="padding: 2px;">5. _____</td><td style="padding: 2px;">12. _____</td><td style="padding: 2px;">19. _____</td></tr> <tr><td style="padding: 2px;">6. _____</td><td style="padding: 2px;">13. _____</td><td style="padding: 2px;">20. _____</td></tr> <tr><td style="padding: 2px;">7. _____</td><td style="padding: 2px;">14. _____</td><td style="padding: 2px;">21. _____</td></tr> </tbody> </table>									Workers Involved (print and sign)			1. _____	8. _____	15. _____	2. _____	9. _____	16. _____	3. _____	10. _____	17. _____	4. _____	11. _____	18. _____	5. _____	12. _____	19. _____	6. _____	13. _____	20. _____	7. _____	14. _____	21. _____
Workers Involved (print and sign)																																
1. _____	8. _____	15. _____																														
2. _____	9. _____	16. _____																														
3. _____	10. _____	17. _____																														
4. _____	11. _____	18. _____																														
5. _____	12. _____	19. _____																														
6. _____	13. _____	20. _____																														
7. _____	14. _____	21. _____																														
<table border="1" style="width:100%; border-collapse: collapse;"> <thead> <tr> <th colspan="2" style="text-align: left; padding: 2px;">Topics to be reviewed (as applicable):</th> </tr> </thead> <tbody> <tr> <td style="width:50%; padding: 2px; vertical-align: top;"> <input type="checkbox"/> Confined Space Classification  <input type="checkbox"/> Confined Space Entry Checklist  <input type="checkbox"/> Hazard Assessment and Controls  <input type="checkbox"/> Procedures/plans to be followed  <input type="checkbox"/> Permit Requirements  <input type="checkbox"/> Communication Systems  <input type="checkbox"/> Isolation of energy sources and control of materials movement                             </td> <td style="width:50%; padding: 2px; vertical-align: top;"> <input type="checkbox"/> Air Testing Requirements  <input type="checkbox"/> Confined Space Attendant Responsibilities  <input type="checkbox"/> Ventilation  <input type="checkbox"/> Required personal protective and respiratory equipment required for entry  <input type="checkbox"/> Entrant tracking requirements (sign in/out with confined space attendant)  <input type="checkbox"/> Conditions under which entry is not allowed or must be terminated  <input type="checkbox"/> Emergency equipment and inspection of equipment  <input type="checkbox"/> Rescue plan                             </td> </tr> </tbody> </table>									Topics to be reviewed (as applicable):		<input type="checkbox"/> Confined Space Classification <input type="checkbox"/> Confined Space Entry Checklist <input type="checkbox"/> Hazard Assessment and Controls <input type="checkbox"/> Procedures/plans to be followed <input type="checkbox"/> Permit Requirements <input type="checkbox"/> Communication Systems <input type="checkbox"/> Isolation of energy sources and control of materials movement	<input type="checkbox"/> Air Testing Requirements <input type="checkbox"/> Confined Space Attendant Responsibilities <input type="checkbox"/> Ventilation <input type="checkbox"/> Required personal protective and respiratory equipment required for entry <input type="checkbox"/> Entrant tracking requirements (sign in/out with confined space attendant) <input type="checkbox"/> Conditions under which entry is not allowed or must be terminated <input type="checkbox"/> Emergency equipment and inspection of equipment <input type="checkbox"/> Rescue plan																				
Topics to be reviewed (as applicable):																																
<input type="checkbox"/> Confined Space Classification <input type="checkbox"/> Confined Space Entry Checklist <input type="checkbox"/> Hazard Assessment and Controls <input type="checkbox"/> Procedures/plans to be followed <input type="checkbox"/> Permit Requirements <input type="checkbox"/> Communication Systems <input type="checkbox"/> Isolation of energy sources and control of materials movement	<input type="checkbox"/> Air Testing Requirements <input type="checkbox"/> Confined Space Attendant Responsibilities <input type="checkbox"/> Ventilation <input type="checkbox"/> Required personal protective and respiratory equipment required for entry <input type="checkbox"/> Entrant tracking requirements (sign in/out with confined space attendant) <input type="checkbox"/> Conditions under which entry is not allowed or must be terminated <input type="checkbox"/> Emergency equipment and inspection of equipment <input type="checkbox"/> Rescue plan																															
Pre-Entry Meeting Notes: _____ _____ _____																																
Part 7: Periodic Atmospheric Testing Results																																
Time of Test																																
Tester's Name																																
Tester's Initials																																
O <sub>2</sub>																																
H <sub>2</sub> S																																
LEL																																
CO																																
Benzene																																
Other (Specify) _____																																
Other (Specify) _____																																
Part 8: Entrant Tracking (Completed by the Confined Space Attendant)																																
Confined Space Attendant Name:				Confined Space Attendant Signature:																												
Entrant Name (First and Last)	Entry Time	Exit Time	Entry Time	Exit Time	Entry Time	Exit Time	Entry Time	Exit Time																								
1.																																
2.																																
3.																																
4.																																
5.																																
6.																																
7.																																
8.																																
9.																																
10.																																
11.																																
12.																																
13.																																
14.																																
15.																																
16.																																
Confined Space Attendant Notes: _____ <input type="checkbox"/> Communication system with entrants: _____ <input type="checkbox"/> Communication system with responsible supervisor: _____ <input type="checkbox"/> Communication system with rescue team: _____																																

VERSION 1 (March 30, 2019)

Distribution: White – Permit Receiver, Gold – Permit Issuer Retain white copy

### 11.3 CONFINED SPACE RESCUE PLAN – TEMPLATE

CONFINED SPACE RESCUE PLAN



Name: \_\_\_\_\_ Job/Task: \_\_\_\_\_

Confined Space Dimensions: \_\_\_\_\_ Date: \_\_\_\_\_

Confined Space Location: \_\_\_\_\_

Entry and exit points: \_\_\_\_\_

Number of workers involved in Confined Space Entry work:  
Max: \_\_\_\_ Min: \_\_\_\_

#	Equipment List	Entry	Rescue	N/A	Pre-Use Inspection	Location
1.	FR Coveralls, hard hat, safety boots/glasses					
2.	Gloves: Type: _____ per FLHA					
3.	SCBA (Self Contained Breathing Apparatus)					
4.	AP Respirator (1/2, Full); Cartridge Type: _____					
5.	Air Horn/ Mobile Phone/Radio					
6.	First Aid Kit					
7.	Full Body Harnesses					
8.	Monogoggles /Face Shield					
9.	Fire Extinguisher Type: ABC Size: 20lb					
10.	Stretcher/Back Board					
11.	Retrieval system: Rollgliss; Other					
12.						

**Rescue Team Members & Response Roles**

**Confined Space Attendant (Safety Watch) Duties**

- Sound alarm; direct everyone to a safe area, contact control room, rescue team, and/or client representative, and assist rescue team.

Name:	Phone Number:

**Confined Space Entry Supervisor**

- Direct all equipment to be shut down, and leave the area. Assist in the rescue of casualties, if safe to do so, as outlined in the rescue procedure.

Name:	Phone Number:

CONFINED SPACE RESCUE PLAN



**Rescuers:**

*(Rescuers must be notified prior to work starting that they may need to respond, and their duties.)*

- Identify Rescuers for entry; don required PPE/RPE to ensure protection of Rescue Team. Enter the confined space and initiate the rescue/retrieval of victims. Additional personnel to assist as required.
- Rescuers must be trained in: first aid, CPR, and Confined Space rescue and equipment training

Name	Company / Job Title	Phone Number

**Basic & Initial Response Strategy**

**1.0 Evacuate**

- Evacuate out of proximity to safe area and shut off all equipment if safe to do so.

**2.0 Alarm**

- Sound alarm and the assigned Confined Space Attendant (Safety Watch) will initiate response communication & coordination with client representative / control room.

**3.0 Assess the Situation**

- When assessing the situation prior to commencing rescue, the following must identified prior to entry and updated at time of entry:

**A) Known Hazards:**

<ul style="list-style-type: none"> <li>▪</li> </ul>
---

**B) The Possible Injuries that could arise to the Victim(s). Complete before initial entry:**

--

**4.0 Protect the Rescuer**

- The following additional protective equipment shall be worn by the rescuers.

PPE for a Hazardous Atmosphere	PPE for a Non Hazardous Atmosphere

CONFINED SPACE RESCUE PLAN



**5.0 Rescue Plan**

- a) The Rescue Team will don the PPE/RPE noted above for their protection.
- b) Entering/Retrieval Team enter the confined space to retrieve victim(s). While one Rescue Team member and Confined Space Attendant (Safety Watch) remains outside the entry point ready to provide assistance. Identify any obstacles to removing an injured worker
- c) **Retrieval practices of victim(s)** from within this confined space will include the following steps:

1.
2.
3.
4.

**6.0 Provide First Aid**

If required the assigned first aid shall administer the necessary first aid treatment (this may include providing rescue breathing).

#	NAME of FIRST AIDER	COMPANY/CONTACT NUMBER
1.		
2.		
3.		
4.		

**7.0 Transport Victim to get Medical Attention:**

Address/phone number of the nearest location for Medical Aid Attention is noted below:

CONTACT:	PHONE NUMBER:
Ambulance:	
Hospital:	
Medical Center:	
STARS	
Stars Location:	
STARS Site ID:	



**11.4 CONFINED SPACE RESCUE PLAN – TEMPLATE**

**CONFINED SPACE ENTRY PLAN**



Name: \_\_\_\_\_ Job/Task: \_\_\_\_\_

Confined Space Dimensions: \_\_\_\_\_ Date: \_\_\_\_\_

Confined Space Location(# and name if applicable): \_\_\_\_\_

Entry and exit points: \_\_\_\_\_

**Reclassification of a confined space (if applicable):**

If a permit required confined space is to be reclassified to a non-permit status, the process will be documented in this section. This plan will be made available to workers at the site to communicate how hazards have been eliminated and/or controlled. This process is to be completed once and remains in effect for the duration of the work as long as the hazards remain eliminated and/or controlled. If a space is reclassified, only this portion of the plan will need to be completed.

- There is not an actual or potential hazardous atmosphere (mechanical ventilation cannot be required to maintain the atmosphere)
- The space does not contain a material that has the potential for engulfing an entrant
- The space does not have an internal configuration such that an entrant could be trapped or asphyxiated
- The space does not contain any other recognized serious safety or health hazards as documented below:

Types of Hazards Eliminated	How Hazard was Eliminated

**Permit Required and Alternate Entries into Confined Spaces:**

Hazards	Controls

**CONFINED SPACE ENTRY PLAN**



**Roles**

Role	Name(s)
Entry Supervisor:	
Attendant:	
Permit Issuer:	
Site or Worker Supervisor:	
Rescue Personnel:	

Number of workers involved in Confined Space Entry work:  
Max: \_\_\_\_ Min: \_\_\_\_

**Work Activity:**

Outline task(s) taking place within the confined space:

**Ventilation Calculation**

Volume of Space \_\_\_\_\_ cubic feet X 20 (# of air changes) = \_\_\_\_\_ minutes  
Ventilation device flow rate \_\_\_\_\_ CFM

**Verification of Lockout/ Isolation**

All lockout/ tagout completed following the Control of Hazardous Energy Standard

**Required Equipment**

#	Equipment List	Entry	Rescue	N/A	Location
1.	FR Coveralls, hard hat, safety boots/glasses				
2.	Gloves: Yes Type: Leather per FLHA				
3.	SCBA (Self Contained Breathing Apparatus)				
4.	AP Respirator (1/2, Full); Cartridge Type:				
5.	Air Horn/ Mobile Phone/Radio				
6.	First Aid Kit				
7.	Full Body Harnesses				
8.	Monogoggles /Face Shield				
9.	Fire Extinguisher Type: ABC Size: 20lb				
10.	Stretcher/Back Board				
11.	Retrieval system: Rollgiss; Other				
12.	Lifelines				

**CONFINED SPACE ENTRY PLAN**



**Duties of Entry Participants**

<b><u>Role</u></b>	<b><u>Responsibilities</u></b>	<b><u>Name or Title</u></b>
<p><b><u>Entrants</u></b> Authorized to enter a permit space and do work</p>	<ul style="list-style-type: none"> <li>• Know the hazards that they may encounter during entry</li> <li>• Properly use equipment</li> <li>• Communicate with attendant as needed alerting of hazards</li> <li>• Exit from permit space whenever ordered to evacuate, a hazard is recognized, or an evacuation alarm is activated</li> </ul>	<p>[Click here to enter names or positions.]</p>
<p><b><u>Attendants</u></b> Stationed outside of a permit space to monitor entrant activity and perform duties listed on the permit</p>	<ul style="list-style-type: none"> <li>• Know the hazards of the space</li> <li>• Know the symptoms of hazard exposure in entrants</li> <li>• Keep track of and record the entrants in the permit space</li> <li>• Remain outside the space during operations until relieved</li> <li>• Monitor the work area for hazardous conditions</li> <li>• Summon rescue and emergency services</li> <li>• Communicate with entrants to relay information and monitor the status of the entrants</li> <li>• Order the evacuation of the entrants from the space if a hazardous condition is encountered</li> <li>• Keep unauthorized employees away from the space</li> <li>• Perform no duties that might interfere with the attendant's primary duty to monitor and protect the entrants</li> <li>• Ensure the space has been completely evacuated in the event of an emergency</li> <li>• Ensure proper signage/ barricades are in place to prevent unauthorized entry</li> </ul>	<p>[Click here to enter names or positions.]</p>
<p><b><u>Entry Supervisor</u></b> Authorize and supervise permit-required confined space entry operations</p>	<ul style="list-style-type: none"> <li>• Conduct the pre-entry meeting</li> <li>• Recognize potential hazards during entry, signs/symptoms of exposure</li> <li>• Before entry, determine that area conditions meet requirements of the permit</li> <li>• Ensure a hazard assessment is completed prior to entry</li> <li>• Provide necessary equipment, hazardous material information, and assuring rescue services are in place</li> <li>• Assure entrants and attendants are trained prior to entry</li> <li>• Determine that entry operations and conditions remain consistent with the terms of the permit</li> <li>• Remove unauthorized individuals from area during entry operations</li> <li>• Cancel the permit at the conclusion of the entry</li> </ul>	<p>[Click here to enter names or positions.]</p>



CONFINED SPACE ENTRY PLAN



**Sample Entry Procedure:**

1. Complete Confined Space Entry Plan and a Rescue Plan, if applicable, ensuring all Personnel involved understand their duties and responsibility.
2. Obtain and fully complete a Confined Space Entry Permit
3. Ensure all participants in the entry have been trained. Assign duties to all participants.
4. Ensure Proper PPE, ventilation, air monitoring and rescue equipment needed for entry is available, assembled, and in working order.
5. Determine method of communication between entrants and attendant.
6. Verify all air monitors have been calibrated and are in working order.
7. Call the emergency rescue service to alert them of the planned confined space entry.
8. Eliminate any condition making it unsafe to remove the entrance cover.
9. Post signs, barriers and barrier tape as necessary to stop entry. Provide traffic control if necessary.
10. Before entering, lock and tag out (LOTO) any mechanical hazards, gas, water lines, or electrical power. Try to turn the system on after locking out to ensure that there is no energy available.
11. Set up and check out all rescue equipment (e.g. body harness, lifelines, rollgliss) prior to entry.
12. Conduct atmospheric monitoring in the space to ensure that no atmospheric hazards are present. Monitoring must always be conducted immediately before entering any confined space.
  - If the air quality inside the confined space is safe with no fresh air ventilation, and if the only hazard is an actual or potentially hazardous atmosphere that can be controlled by continuous forced air ventilation, the space may be reclassified temporarily as an "Alternate Entry Procedures" space.
13. Write air monitoring results and time taken on the Permit.
14. If air monitoring results or the work to be done in the space indicates that ventilation is needed, set up the ventilation blower so that it takes in clean, uncontaminated air. Do not place intake next to vehicles, gas-powered equipment, or exhaust vent from a lab or other potentially contaminated work area. Attach ducting to blower, turn on, and place exhaust end well inside confined space. Run the blower for the minimum amount of time needed to purge the space for 20 air changes based on the calculations made on the Permit.
15. After ventilation, check the atmosphere in the space again to confirm that acceptable entry conditions are present.
16. If all entry conditions are met, the entry supervisor signs the permit allowing entry to the space.
17. Entrant ensures appropriate PPE is donned
18. Entrant enters the space and checks for hazards that may not have been detected.
19. Continue to monitor the atmosphere in the space throughout entry and record results at pre-determined frequencies
20. Attendant communicates with entrant for entire entry.
21. **Exit the space immediately if any of the following occurs:**
  - A hazardous atmosphere is detected.
  - Any health or safety hazard is detected.
  - If entrant shows signs of exposure to atmospheric hazards, feels ill, notices strong odors or has other safety concerns.
 Re-evaluate space and/or modify entry procedure before re-entering.
22. When work completed, return space to proper condition and secure opening.

End of Document





**CHANGE LOG**

Section	Version 2.1	Version 2.2
Entire document		Clerical corrections including spelling, grammar, and document names.
6.2, 6.7.3, 6.9.2		Updated terminology from incident and investigation to event and analysis
6.9	Workers entering a space assessed as a “High Hazard Atmosphere” must wear a safety harness securely attached to a lifeline.	Correction to removed Canadian term, and align with OSHA.  Workers entering a space assessed as a “permit required confined space” must wear a safety harness securely attached to a lifeline.

<END OF DOCUMENT>



---

# Standard

---

## Control of Hazardous Energy

---

**Effective Date:** 2019-03-30  
**Version #:** 3.2  
**Version Date:** 2024-03-27

---

**CONTROL OF HAZARDOUS  
ENERGY STANDARD**

Version #: 3.2  
Version Date: 2024-03-27



This page intentionally left blank



**CONTROL OF HAZARDOUS  
ENERGY STANDARD**

Version #: 3.2  
Version Date: 2024-03-27



This page intentionally left blank

---

## Table of Contents

1.0	Purpose .....	3
2.0	Scope .....	3
3.0	Prerequisites.....	3
4.0	Definitions & Acronyms .....	3
5.0	Roles & Responsibilities.....	6
6.0	General.....	9
6.1	Isolation .....	10
6.1.1	Safe Work Isolation – Pressurized Piping Systems .....	12
6.2	Lockout/Tagout Requirements .....	12
6.2.1	Lockout Equipment.....	12
6.2.2	Locks.....	12
6.2.3	Tags.....	13
6.2.4	Hasps/Scissor Clamps.....	15
6.2.5	Cable/Bars/Chains.....	15
6.2.6	Lockboxes.....	16
6.3	Lockout Requirements.....	17
6.4	Lockout/Tagout Changes .....	18
6.4.1	Work Disruption .....	18
6.4.2	Scope of Work Changes.....	18
6.4.3	Shift Change .....	18
6.4.4	Isolation for Projects .....	18
6.5	Lockout/Tagout Inspections.....	19
6.6	Lockout/Tagout Assurance Process for Asset Management .....	19
6.7	Contractors .....	20
6.8	Documentation .....	21

---

6.8.1	Energy Isolation Form.....	21
6.8.2	Lock Removal Authorization Form .....	21
6.8.3	Isolation Procedures .....	22
7.0	Training Requirements .....	22
7.1	LOTO Authorized Worker Training .....	22
7.2	Additional Training .....	22
8.0	Related Materials .....	23
9.0	Standard Review .....	23
10.0	References .....	23
11.0	Appendix.....	25
11.1	Appendix A General Lockout/Tagout Process .....	25
11.2	Appendix B - General Removing Isolation and Restoring Equipment Process .....	27
11.3	Appendix C – Energy Isolation Form.....	29
11.4	Appendix D – Lock Removal Authorization Form.....	31
11.5	Appendix E – Isolation over Distance.....	32
11.6	Appendix F Car Seals.....	32
	Change Log.....	33

## **1.0 PURPOSE**

The Control of Hazardous Energy Standard provides minimum requirements to prevent worker exposure to hazardous energy when interacting with operating equipment and systems (i.e. installing, removing, modifying, servicing, maintaining or repairing equipment or systems). Such exposures occur from active or stored energy sources and/or from the unexpected start-up/energization of energy sources.

This standard further provides minimum requirements to prevent equipment and systems from inadvertently being placed into service until all work activities required to return the equipment to service are complete. It also provides minimum requirements to protect systems (piping, electrical) from damage when flow paths of energy sources are required to be temporarily altered from their normal operating configuration.

## **2.0 SCOPE**

This standard applies to all LP and project employees required to perform lockout/tagout activities or who are affected by lockout/tagout of equipment and systems for personal, operational and/or process safety purposes. It does not apply to work on cord and plug-connected equipment or hot tap activities involving transmission and distribution of product through the pipeline.

Contractors and subcontractors shall comply with Enbridge health and safety requirements set out in this standard, as articulated within applicable contractor safety specifications. If a contractor or subcontractor has a health and safety standard or policy materially different from Enbridge's, the contractor/subcontractor shall follow the most stringent requirement. Contractors and subcontractors are still obligated to meet the requirements of all applicable laws related to this standard.

In the event a contractor's or subcontractor's standard exceeds the requirements of this standard, Enbridge may, in its sole discretion, choose to adopt the contractor's or subcontractor's standard for any given contract or work order.

## **3.0 PREREQUISITES**

Electrical Safety Standard

Hazard Assessment, Elimination & Control Standard

Safe Work Permit and Work Authorization Standard

## **4.0 DEFINITIONS & ACRONYMS**

*Active energy* - Primary energy source that is typically controlled with an energy isolation device.



*Affected worker* - A worker whose job requires him/her to operate or use equipment being modified, serviced, maintained, or repaired by others.

*Alternate isolation procedure* - Any procedure used for isolation that does not meet the requirement of positive isolation.

*Authorized worker* - An employee or contractor performing lockout/tagout for installation, modification, servicing, maintenance and/or repair work on equipment and/or systems that has completed lockout/tagout training and is deemed qualified to implement the lockout/tagout requirements as outlined in this standard. The ability to isolate hazardous energy sources associated with the machines, equipment and/or systems being worked on will be limited to those that fall within the scope of their trade/occupation and associated qualifications.

*Blanking* - Inserting a physical barrier through the cross-section of pipe so material is prevented from flowing past that point. Blanks must be rated to contain the design pressure of the piping of the pressurized system.

*Blinding* - Disconnecting a pipe and attaching a physical barrier to the end so material is prevented from flowing out of the pipe. Blinds must be rated to contain the design pressure of the piping of the pressurized system.

**CCO** – Control Centre Operations

*Control of hazardous energy* - Practice of shutting down, isolating, and locking out equipment and systems in accordance with this standard to prevent inadvertent start-up, operation, and release of potentially hazardous energy during work activities.

**COPAS** – Capacity Outage Planning and Approval System

*De-energize* - A process that is used to disconnect and isolate a system from a source of energy in order to prevent the release of that energy.

*Double isolation and bleed (DIB) system*– When two seating surfaces, in the closed position, provide a seal against pressure from both sides with a means of venting/bleeding the cavity between the seating surfaces. DIB can be achieved by a single valve or by two valves with a bleed in between.

*Energized* - Connected to an energy source or containing residual or stored energy.

*Energy isolation device* - A mechanical device that physically prevents the transmission or release of energy from a hazardous energy source.

**ESWCF** - Electrical Switching and Work Clearance Form

**EIF** – Energy Isolation form

*Equipment Locksets* – A pre-defined number of equipment locks in any color, other than red, engraved with a unique identifier. Equipment Locksets are used for the protection of equipment or to manage a temporary flow path. They may be keyed alike.

*Equipment locks* - Locks in any color, other than red, used for the protection of equipment or to manage a temporary flow path. They may be keyed alike.

*FLHA* – Field Level Hazard Assessment

*Group lockout* - A lockout that is utilized when multiple workers/trades are performing service, maintenance, or repair to a piece of equipment or system

*Hasps (scissor clamps)* - A mechanical device that is used to secure an energy isolation device in position when installed in combination with one or more locks.

*Hazardous energy* - Any active or stored source of energy that may cause harm to people, property or process.

*Isolated / De-energized* – when all sources of energy, including residual or stored energy, have been disconnected or otherwise controlled

*Isolation Over Distance* - An isolation activity requiring isolation at more than one location, where one or more of the locations are not within the same facility that service/maintenance is to be performed.

*Isolation Point* - The location where an energy isolation device is installed.

*Isolation* - Securing one or more isolation points on equipment or within a system in accordance with an established procedure in order to eliminate any potential sources of active and stored hazardous energy.

*Lockbox* - A container that securely stores lock keys and unused locks from locksets.

*Lockout Authority (LOA)* - Individual (one per shift) must be an authorized worker and is accountable for overall coordination and implementation of isolation and lockout/tagout activities required to control hazardous energy in accordance with this standard.

*Lockout* - The placement of personal or equipment locks (individual or lockset locks) on an energy isolation device in order to prevent equipment or a system from being operated until the lock has been removed.

*LOTO* – Lockout Tagout

*MCC* – Motor Control Center

*OMM* – Operations and Maintenance Manuals

*P&ID* – Piping and Instrumentation Diagram

*Positive Isolation* - Isolation of harmful pressurized fluid (liquid or gas) by means of blanking, blinding, or double isolation and bleed (DIB).

*Qualified* - one who, by possession of a recognized degree, certificate or professional standing or who by extensive knowledge, training and experience, has successfully demonstrated his ability to solve or resolve problems relating to the subject matter, the work, or the project.

*Red Locksets* - A pre-defined number of locks (red) engraved with a unique identifier that are keyed alike.

*Red Personal Locks* - are keyed individually and used for the protection of people. Red personal locks are assigned to an individual.

*Simple Lockout* – a lockout involving the application of a single lock where the work does not involve an open system or high voltage (above 600 Volts - US, above 750 Volts - Canada), and only a single source of energy is required to be isolated.

*Stored energy* - Residual energy that remains in equipment or systems after operation/installation of an energy isolation device until further relieved, restrained, disconnected or otherwise dissipated.

*Tagout* - The placement of a prominent warning device, such as a tag and a means of attachment, which can be securely fastened on an energy isolating device, in accordance with an established procedure, to indicate that the energy isolating device and the equipment being controlled may not be operated until the tagout device is removed.

*Verify* - Ensuring that equipment and/or piping is isolated and at a zero-energy state, using some sort of test method (bump test, activation attempt, voltmeter, etc.).

*Zero energy state* - A condition where all active and stored energy to and within equipment or a system has been removed.

## **5.0 ROLES & RESPONSIBILITIES**

People leaders shall:

- Ensure, through formal and informal inspections, that employees, contractors, and subcontractors under their control are aware of and comply with this standard,
- Ensure workers are appropriately trained
- Ensure that equipment and systems that are required to be serviced, maintained and repaired are isolated prior to work beginning

- Ensure the lockout/tagout equipment is readily available,
- Support development of equipment specific isolation and lockout procedures and completion of associated Energy Isolation Forms as required.

Lockout authority shall:

- Implement and ensure compliance with the requirements of this standard,
- Complete training for the control of hazardous energy,
- Stop/correct any issues of non-compliance with this standard,
- Coordinate and implement group lockout and isolation over distance when required,
- Ensure an Energy Isolation Form and/or Electrical Switching and Work Clearance Form are completed,
- Perform or assign a designate to perform initial isolation of equipment and systems requiring lockout/tagout,
- Verify the isolation (test to ensure it is at a zero-energy state),
- Implement the use of scissor locks/hasps at each isolation point or utilize a designated lockbox when required to accommodate group lockouts,
- Ensure all authorized workers working on equipment and systems being serviced, maintained and repaired lockout and tag the appropriate isolation point(s) or that they apply a lock on a designated lockbox,
- Manage changes to personnel, isolation points, equipment status and isolation documentation associated with a lockout/tagout and informing personnel of such changes, and
- Notify affected workers of the shutdown, isolation, lockout/tagout and re-energization of equipment and systems. This includes notifying the CCO as outlined in this standard (e.g., if equipment is in flow path that CCO is responsible for controlling or operating).

Authorized worker shall:

- Complete training for the control of hazardous energy,
- Comply with the requirements of this standard and stop/correct any issues of

non-compliance,

- Follow the direction of the lockout authority (LOA) as it relates to isolation and lockout activities,
- Confirm the necessary testing has been performed to verify that hazardous energy sources have been isolated prior to applying personal locks and tags to isolation points of equipment and systems or a designated lockbox,
- Apply a personal lock and tag on each isolation point identified on the Energy Isolation Form or on a designated lockbox prior to working on any equipment and systems required to be isolated and/or locked out/tagged,
- Remove personal locks/tags applied to isolation points or a lockbox when task is complete or at the end of each day/shift (whichever comes first), unless otherwise authorized to leave personal locks on for work that will extend greater than one day/shift in accordance with the limitations in this standard,
- Inform the lockout authority of the status of their work and of any equipment and systems being worked on at the end of each working day/shift or when their work is complete and their personal locks/tags are ready to be removed (whichever comes first), and
- Act as the lockout authority (LOA) when working alone or assigned to fulfill this role for a group lockout or isolation over distance.

Affected workers shall:

- Comply with the requirements of this standard and stop/correct any issues of non-compliance, and
- Not alter or attempt to reactivate any equipment or systems that have been isolated and locked/tagged out for the control of hazardous energy in accordance with this standard.

Contractors shall, as articulated within the applicable contractor safety specifications:

- Implement an effective control of hazardous energy standard that meets or exceeds all applicable regulatory requirements and the requirements set out in this standard,
- Ensure workers, through formal and informal inspections, under their control are aware of and comply with the requirements of the control of hazardous energy standard and the applicable requirements of this standard,

- Ensure workers are trained in the control of hazardous energy as required and provide record of training when requested,
- Provide lockout/tagout equipment required for implementation of their control of hazardous energy standard and the applicable requirements of this standard and ensure it is readily available to their workers, and
- Support development of equipment specific isolation and lockout procedures and completion of associated Energy Isolation Forms as required.

Safety Department shall:

- Maintain and continuously improve this standard,
- Ensure that the work practices within this standard meet or exceed the legislative requirements dictated by the jurisdiction the work is being completed in,
- Provide timely advice, support and assistance regarding implementation of this standard,
- Assist with lockout/tagout equipment selection as needed,
- Conduct periodic assessments of the overall effectiveness of implementation of the control of hazardous energy standard, and
- Develop the curriculum for control of hazardous energy training and support delivery of training as required.

## **6.0 GENERAL**

The implementation of appropriate energy isolation processes in conjunction with effective lockout/tagout processes is required to control hazards to people, property and processes arising from exposures to hazardous energy (see Appendix A - General Lockout/Tagout Process). Impacts arising from hazardous energy to be controlled include:

- A. Personal injuries as a result of exposure to a hazardous energy source from unexpected start-up and/or operation of equipment and systems (piping, electrical etc.) while performing installation, alteration, maintenance, service and repair work, and/or
- B. Equipment damage and process safety impacts as a result of failure to:

- Return equipment isolation devices, protective devices, vents and drains to their normal operating position upon completion of work on equipment and systems before returning equipment to service,
- Properly remove equipment from service while waiting for completion of repairs or replacement,
- Properly remove equipment from service while waiting for completion of long-term maintenance activities associated with downstream facilities (e.g. tank maintenance), and/or
- Properly manage changes to operating positions of equipment isolation devices in order to temporarily alter flow paths as required for operations and maintenance activities.

## 6.1 ISOLATION

The following table provides a list of hazardous energy types that must be controlled through use of isolation and lockout processes along with examples of typical sources and methods for isolation.

Category	Hazardous Energy Types & Examples of Sources	Methods of Isolation for Hazardous Energy Types
<b>Electrical Equipment, Circuits &amp; Parts</b>	<p><b>Electrical (High/Low Voltage)</b> – transformers, overhead buss, electrical circuits &amp; parts, motors, switchgear, MCC, electrical disconnect switches, breakers, capacitors, cathodic protection impressed current sources (e.g., rectifiers)</p> <p><b>Mechanical</b> – spring loaded breakers</p>	<p><b>Electrical</b> – open disconnect switches/breakers, disconnection cables/wires, install safety grounding and bonding.</p> <p><i>Note: See Electrical Safety Standard and OMM Book 6 for Electrical Isolation Procedures</i></p> <p><b>Pressure/Chemical/Biological /Thermal</b> - Shut down</p>
<b>Piping Systems &amp; Associated Equipment</b>	<p><b>Pressure</b> – pumps, compressors, piping, tanks, valves etc.</p>	

	<p><b>Mechanical</b> – rotating pump shafts, tank mixers, valves in travel etc.</p> <p><b>Electrical</b> – induced alternating current (AC), electrostatic charge</p> <p><b>Chemical</b> – product in pumps, piping, tanks, valves etc.</p> <p><b>Biological</b> – products in tanks and piping (e.g., waste)</p> <p><b>Thermal</b> – boilers, heat exchangers, hot product in piping</p>	<p>pumps/compressors, close valves, depressurize system, drain-up product, disconnect piping, install blanks and blinds, utilize approved isolation tools.</p> <p><i>Note: See Section 6.1.1 below for Safe Work Isolation Requirements for Piping Systems</i></p> <p><b>Mechanical</b> – Shut down equipment, disconnect couplings, block or secure parts</p> <p><b>Radiation</b> - Close shutter, shielding</p>
<b>Nuclear Densitometers</b>	<b>Radiation</b>	
<b>HVAC/Ventilation Systems</b>	<p><b>Electrical</b> – electrical systems</p> <p><b>Mechanical</b> – fans</p>	<i>Note: See Locking Out Nuclear Devices Procedure in OMM Book 3.</i>
<b>Equipment</b>	<p><b>Mechanical</b> – rotating drive shafts, cooling fans, moving parts</p> <p><b>Electrical</b> – electrical systems</p> <p><b>Pressure</b> – hydraulic &amp; cooling system hoses</p> <p><b>Gravity</b> – elevated equipment/parts</p>	<b>Gravity</b> – Block or otherwise secure/restrain parts

The extent of isolation required to control hazardous energy will depend on the purpose of the isolation (personal protection, equipment protection, or flow path management) and the scope of work (if any) being performed on the equipment and systems. Isolation of active energy sources can be achieved through operation of one or more energy isolating devices. Isolation of stored energy will require the energy to be bled off (e.g., venting of piping, electrical grounding) or otherwise restrained/secured (mechanical blocking). Energy isolation devices on equipment must be capable of being locked out or tagged out, meaning lockout equipment or a tag can be affixed or it has a locking mechanism built into it.



### **6.1.1 SAFE WORK ISOLATION – PRESSURIZED PIPING SYSTEMS**

Open system work on pressurized piping systems or connected equipment must be performed either with positive isolation between the pressurized portion of the system and the section where the work is being performed or, if positive isolation is not reasonably practicable, with a written alternate isolation procedure approved by a qualified engineer. Contact a regional operations engineer if you require approval for an alternate isolation procedure.

*Note: Refer to Verifying Double Isolation & Bleed (DIB) procedure in OMM Book 3 where this method of positive isolation is being utilized.*

Where there is a risk of thermal pressure build-up within an isolated piping system, a plan to manage thermal pressure risks and a communication plan must be submitted to the CCO with the COPAS request. The communication plan will include provisions for the CCO operator to contact field personnel involved in the work activities if rising thermal pressures above pre-established limits are identified within isolated facilities.

## **6.2 LOCKOUT/TAGOUT REQUIREMENTS**

### **6.2.1 LOCKOUT EQUIPMENT**

Lockout equipment must:

- Be provided to the authorized worker as required,
- Not be used for purposes other than LOTO,
- Be capable of withstanding the environment in which it will be exposed for the period of time that exposure is expected, and
- Be substantial enough to prevent removal without the use of excessive force or unusual techniques (i.e., bolt cutters, metal cutting tools).

Tampering with any LOTO equipment is a serious offense and will result in disciplinary action.

### **6.2.2 LOCKS**

The four types of locks used in LOTO to secure an isolation device in the appropriate position are red personal locks, red locksets, equipment locks, and equipment locksets.

#### **6.2.2.1 Red Personal Locks/ Red Locksets**

Red Personal locks are individually keyed locks with one key per lock that must be kept in the control of the worker who applies the lock. Work groups may uniquely assign red personal locks

to workers (e.g., name or unique number assigned to worker engraved on lock) or may set up communal red personal locks that are issued when necessary for workers to use.

Red locksets are keyed alike with one key for the entire set of locks. Each lock in a red lockset is uniquely identified as being part of a set. Work groups may uniquely assign red locksets to workers (e.g., name or unique number assigned to worker engraved on lock) or may set up communal red locksets that are issued when necessary for workers to use. They are commonly used in group LOTO situations or a LOTO with multiple isolation points. More than one red lockset can be used during an isolation. Lockset keys must be locked in the lockbox. Keys for red personal locks/ red locksets must not be duplicated.

#### **6.2.2.2 Equipment Locks/Locksets**

Equipment locks and/or locksets may be color coded, provided they are not red, to act as a visual indicator of locks used by different trades/occupations. The color coding of equipment locks and/or locksets must be consistent within and understood across the region (or facility).

Equipment locks are individually keyed or keyed alike for an equipment lockset. When in a lockset, each lockset will be uniquely identified. Equipment locks may have multiple duplicate keys with the keys being issued to workers in the department/location where the equipment locks are being used. Equipment locks may be used for:

- Long-term equipment shutdown,
- Out-of-service equipment,
- Isolations where protection to workers is not required, and
- Isolations for temporary alteration of a flow path provided a management of change (MOC) process is followed and procedure is documented.

If an authorized worker is isolating equipment for another work group or contractor but not performing the work themselves (i.e., electrician locking out for a mechanic), they may use equipment locks at the isolation points. The working group is responsible for applying red personal locks/red lockset locks to the isolation points.

Performing work on isolated equipment or systems with just an equipment lock is prohibited.

### **6.2.3 TAGS**

Tags are used to indicate which department or individual has isolated and/or locked out an energy source. An authorized worker must attach a tag to each lock being installed for a lockout. In cases where an energy isolation device cannot physically accommodate the placement of a lock on it, tags shall be used without the lock.

Tags must be applied to any blanks or blinds being installed for isolation and any auxiliary piping valves used multiple times for drain-up and venting. Tags used for these purposes can be used without locks. Each tag's location must be documented on the Energy Isolation Form along with the equipment positions prior to starting work and when work is completed.

Tags must be:

- Designated for LOTO,
- Legible and understandable to others,
- Constructed and printed in a way that ensures they do not deteriorate or become illegible, and
- Substantial enough to prevent inadvertent or accidental removal, and
- Replaced if weathered or illegible.

#### 6.2.3.1 Photo Identification Tags

All Enbridge authorized workers will be issued at least one photo identification (ID) tag and must, at a minimum, include the worker's:

- Photo,
- Name,
- Department or job title, and
- Phone number

#### 6.2.3.2 Generic Tags

A generic tag can be used in place of a photo ID tag if the authorized worker does not have a photo ID tag available and must, at a minimum, include the worker's:

- Name,
- Department or job title, and
- Phone number

#### 6.2.3.3 Group Tags

Group tags can be attached to the shank of lockset locks placed on individual energy isolation points for group lockouts utilizing a lockbox and must, at a minimum, include:

- LOA's department

- Department contact, and
- Department contact phone number

A photo ID or generic tag must be applied to each red personal lock placed on the lockbox.

#### 6.2.3.4 Equipment Lock Tags/Identifiers

Equipment locks must have a durable tag or identifier appropriate for the environment and must include:

- Worker name or department,
- Date of application, and
- Reason for isolation.

#### **6.2.4 HASPS/SCISSOR CLAMPS**

Hasps/scissor clamps are used to increase the number of locks that can be attached to one isolation point. They are designed so they cannot be opened or removed until all locks are removed and can be attached to each other (daisy chaining) to allow for additional locks at the one isolation point.

#### **6.2.5 CABLE/BARS/CHAINS**

When a lock cannot be physically applied, an alternative securing device shall be used on the isolation point to prevent inadvertent operation/movement. The strength, diameter and routing of cables, bars or chains must be sufficient to prevent removal without tools and keep the energy isolating device in the appropriate position.

In some situations, several energy isolating devices may be locked near one another and must be secured at the same time. One approach is to use a lock to secure each energy-isolating device in its off or safe position. Also acceptable is the practice of running a cable, bar or chain through the lock points of the energy isolating devices (once they are in the appropriate position), then securing the cable, bar or chain against removal with a lock.

There is no limit on the length of cable, bar or chain that is acceptable, or the maximum number of energy-isolating devices that may be secured at one time. The system must provide a level of worker protection that is at least as good as if there was an individual securing device on each energy-isolating device.

## **6.2.6 LOCKBOXES**

Lockboxes are used to simplify lockout procedures for group lockout. If an LOA isolates a system on behalf of a group, the LOA must place the keys to the red personal locks and/or the red locksets used to isolate the system inside a lockbox and secure it closed with their red personal lock on the front of the lockbox. This lockbox is referred to as the primary lockbox and becomes the single isolation point of the system.

Each authorized worker required to work on the system must place a red personal lock on the lockbox. This ensures that the keys cannot be removed from the lockbox until each worker removes their red personal lock.

Where more than one job is taking place on isolated equipment or systems, a separate LOTO is required and must be documented for each job. A LOA must be established for each job. Each LOA must place their personal lock on each energy isolation device including those devices that are common points of isolation for more than one job. The need for LOAs to place a red personal lock on each other's lockboxes in addition to locking out each energy isolation device must be determined on a case-by-case basis at control and coordination meeting.

Authorized workers must be aware of the location of the lockbox at all times.

Lockboxes must be:

- Lockable,
- Sealable,
- Readily identifiable,
- Used for one isolation at a time,
- Used to store the lockset key and any unused lockset locks,
- Able to accept a lock or a multiple lockout device, securing the box from unauthorized access, and
- Free from damage preventing its proper use.

Larger jobs with multiple workers may require the use of a secondary lockbox in conjunction with a primary lockbox. Instead of having all authorized workers LOTO at the primary lockbox, workers can LOTO at a secondary lockbox set up by their crew lead (e.g., a crew lead attaches a red personal lock (or red lockset lock) to the primary lockbox then places their key to that red personal lock/red lockset lock into a secondary lockbox). The authorized workers on their crew must LOTO at the secondary lockbox.

The LOA's personal lock and tag are always the first on the lockbox and the last off the lockbox. The LOA's lock will be placed at the front securing point of the lockbox.

### **6.3 LOCKOUT REQUIREMENTS**

One lockout authority (LOA) is required for every personal LOTO. For a one-worker LOTO, the authorized worker performing the work automatically becomes the LOA. For a group LOTO (more than one worker), one authorized worker must be designated as the LOA.

The LOA or designate will be the first to apply red personal locks and or red locksets on each energy isolation device and/or a lockbox used as a single point of isolation once the isolation has been verified. Once the initial lockout is complete, each authorized worker performing work on the isolated machines, equipment and systems must then install their own red personal locks on each energy isolation device or a lockbox if used.

Once the work is complete, each authorized worker that applied a lock must remove it from the energy isolating device and/or lockbox. The lockout authority will be the last person to remove their personal locks and or red locksets from the energy isolation devices (see Appendix B – General Removing Isolation and Restoring Equipment Process). Prior to doing so, the LOA must ensure:

- The work has been completed or otherwise rendered safe prior to returning the equipment or system to operation,
- All personnel and tools are accounted for,
- All energy isolation devices have been returned to their proper operating position, and
- All affected personnel have been notified of the plan to re-energize. This includes notifying the CCO as appropriate (e.g., if equipment is in flow path that CCO is responsible for controlling or operating).

Any auxiliary piping valves required to be operated multiple times for venting and drain up following initial isolation can only be operated by the LOA or their designate(s) and shall be tagged (no lock required). The location of these valves and name of the designate authorized to operate these valves must also be documented on the Energy Isolation Form. Where the Energy Isolation Form is used to document the shutdown/isolation steps, the steps for opening and closing the drain/vent valves should be included on the Energy Isolation Form. Where the shutdown isolation steps are documented elsewhere (e.g., Open System Job Planning Template) and the Energy Isolation Form is issued to simply list the points of isolation, the Equipment Status of the drain/vent valves that require to be operated should be noted as both open/closed (O/C) "During Isolation" on the Energy Isolation Form.

A worker installing a personal red lock is the only person authorized to remove the lock and tag (the exception would be long-term isolation for contractor use as noted in Section 6.7). A worker cannot apply a lock on behalf of another person and may only remove another person's lock where authorized in accordance with the requirements of the Lock Removal Authorization Form (see Section 6.8.2).

## **6.4 LOCKOUT/TAGOUT CHANGES**

### **6.4.1 WORK DISRUPTION**

If there is a work disruption or the locked-out equipment will not be worked on for more than 7 calendar days, replace all personal red locks/red locksets with equipment locks/locksets. Before resuming work, replace equipment locks/locksets with personal red locks/red locksets and verify isolation.

The exception is where a lockbox is used, red personal locks/red locksets may remain on each energy isolation device provided all red personal locks on the lockbox are removed and the LOA's red personal lock on the lockbox is replaced with an equipment lock. Keep isolation point information on the EIF and store with the lockbox. Prior to resuming work, red personal locks must replace the equipment lock(s) and isolation must be verified.

### **6.4.2 SCOPE OF WORK CHANGES**

If the scope of work changes during isolation, the LOA must immediately stop the work, review the isolation validity and once confirmed safe, allow work to resume.

If the scope of work change affects the isolation security and/or worker safety, the Energy Isolation Form must be updated and authorized/affected workers must be notified.

### **6.4.3 SHIFT CHANGE**

If work is to span over the course of multiple shifts, the LOA must complete a transfer of responsibilities during shift change. The incoming Lockout Authority must re-verify the lockout prior to applying their personal red lock(s)

### **6.4.4 ISOLATION FOR PROJECTS**

When isolating equipment for projects, document isolation point verifications and expectations for equipment/department lock use (tagging, color codes, etc.) on the Energy Isolation Form. When locking out equipment for project work, a secondary lockbox may be used, with the Project Inspector placing a lock on the original lockbox and their key locked in the secondary lockbox.

When isolating for project work site operations staff are responsible for isolation verification before turnover and bringing assets back into operations control.

## **6.5 LOCKOUT/TAGOUT INSPECTIONS**

A focused inspection is required to be performed on LOTO within each operating area at least annually to correct any inadequacies identified.

The focused inspection must be performed by an authorized worker other than the worker(s) using the energy control procedure being inspected. The person performing the inspection must review the inspection with the authorized and affected workers of the LOTO being inspected.

## **6.6 LOCKOUT/TAGOUT ASSURANCE PROCESS FOR ASSET MANAGEMENT**

Below are a list of processes used in conjunction with the LOTO procedure to confirm all isolation points and related assets are identified, up to date and align with current standards, procedures, and processes

If an Isolation point is found to be tagged or labeled incorrectly or the tag/label is missing, any work taking place shall be stopped until the tag or label is corrected or replaced.

Processes is for identifying missing or incorrect equipment labels:

- Quality Enhancement Report (QER) Process
- Quality Enhancement Reporting Procedure – GDL (Governance Documents Library)

If a revision of existing programs or documentation is required, the following change management processes will be followed:

- OMMs (Operations and Maintenance Manuals) – follow B1\_07-02-04\_OMM Management of Change, Creation-Revision-Obsolescence
- Site-Specific Procedures – follow B1\_07-02-05\_Site-Specific Procedures
- Engineering Standards (Functional Tag Number Standard (FTNS)), Equipment Specifications, Construction Specifications & Facility Piping Construction Specifications - TSCR (Technical Standard Change Requests) process
- Control Room Management Plan – LPMOC (when changes affect stakeholders outside of the CCO)
- Work Execution Management – LPMOC



For program changes that do not fall into the above categories, discuss with your people leader.

## **6.7 CONTRACTORS**

Enbridge authorized workers must use company LOTO equipment to isolate the required energy sources prior to contractors performing any activities related to servicing and/or maintenance of equipment at company facilities. The only exception to this rule is when a hired contractor is performing work on cathodic protection rectifiers. Contractors hired for this purpose are allowed to conduct LOTO without direct oversight from an Enbridge Employee/Representative, provided the LOTO follows all Enbridge LOTO requirements.

Contractors may provide their own equipment (i.e., personal locks) for their lockout portion; LOTO for a contractor can be performed using one of the following methods:

- An Enbridge Authorized Worker:
  1. Attaches red personal locks or red lockset locks and tags to the isolation points,
  2. Places the keys in a lockbox,
  3. Attaches a red personal lock to the lockbox, and

The Contractor:

4. Attaches their LOTO equipment to the lockbox;

- 
- An Enbridge Authorized worker:
  1. Attaches a hasp/scissor clamp and red personal lock and tag to each isolation point.

The Contractor:

2. Attaches their LOTO equipment to each isolation point, and
3. Follows their program (e.g., setting up a secondary lockbox for the rest of their crew).
4. If the LOTO does not correspond to the identification of the isolation points, Enbridge lockout authority must stop work and resolve before any work can commence, for resolution see isolation procedure in this standard.

Once the LOTO has been completed, the LOA verifies that the isolated equipment is at a zero-energy state.

If a contractor employee would like to verify isolation, this must be accommodated by the LOA or designate.

Contractor employees who leave the worksite must remove all of their locks and tags from the isolations point(s).

For new construction isolation turnovers or tie-ins into pre-existing systems, all affected parties must communicate the status of the equipment being turned over.

## **6.8 DOCUMENTATION**

### **6.8.1 ENERGY ISOLATION FORM**

An Energy Isolation Form (EIF) is required to be completed for all lockouts except simple lockouts. If utilizing simple lockout, the functional tag and description of the device being isolated and locked out along with the position of the device prior to isolation, during isolation and prior to start-up must be documented on the FLHA. The Energy Isolation Form is not required when solely isolating equipment with equipment locks.

The Energy Isolation Form must be available to all workers performing the lockout during the work (see Appendix C – Energy Isolation Form).

For all work requiring a COPAS, the individual planning and coordinating the work must ensure a copy of the Energy Isolation Form is sent to the CCO with the COPAS request along with the shutdown, isolation and start up procedures (if separate documents). If any changes are made to the form and/or procedures after they have been sent in, the revised form and/or procedures must be re-submitted to the CCO. Once the work is complete and the equipment or system is ready to return to service, the lockout authority or their designate must send a copy of the completed form containing the signatures and initials in to the CCO for use to verify the flow path prior to startup.

### **6.8.2 LOCK REMOVAL AUTHORIZATION FORM**

The Lock Removal Authorization Form applies to all types of locks. Use it if any of the following occurs:

- A lock has been abandoned,
- A key has been lost by a worker or work group, and/or
- An emergency situation develops.

The lock cannot be removed until all abandoned lock removal procedure steps have been performed. Unauthorized removal of a lock by anyone other the worker or department to whom it belongs is prohibited.

If a lock is forcibly removed via the Lock Removal Authorization Form it is to be assumed that Energy Isolation has been lost, and work must be suspended until re-verification of the Energy Isolation has been completed by the LOA or Designate. The person whose lock is being removed, or the department they report to, must be notified of the lock removal.

### **6.8.3 ISOLATION PROCEDURES**

Site specific isolation procedures may be developed when the isolation procedure is consistent (e.g., pigging). If a site-specific isolation procedure has not already been developed, the LOA is responsible for ensuring one is developed and documented prior to the start of work (e.g., Open System Planning Template, Job Hazard Assessment (JHA), Energy Isolation Form, FLHA). If a Pigging Site-Specific Isolation Procedure and associated documentation contains all information from the EIF, then an EIF does not need to be completed. The Safe Work Permit Receiver is considered the LOA in this case.

## **7.0 TRAINING REQUIREMENTS**

Personnel involved in the movement of material must be knowledgeable in this Standard and may be assigned applicable training as identified by the Safety Training Matrix.

Reference the Health & Safety training syllabi and matrices for further information and training re-certification requirements.

### **7.1 LOTO AUTHORIZED WORKER TRAINING**

LOTO authorized worker training is mandatory for authorized workers and must be completed prior to the worker servicing, maintaining, modifying, or repairing any equipment or systems that require Energy Isolation. Such training shall include a review of the roles and responsibilities of the Lockout Authority (LOA).

### **7.2 ADDITIONAL TRAINING**

Additional training must be provided for all authorized and affected workers whenever there is:

- Change in job assignment,
- Change in equipment,
- New equipment or processes that present a new hazard,
- Change in the energy control procedures, or
- Periodic inspection that indicates deviations from, or inadequacies in, the worker's knowledge or application of energy control.

## 8.0 RELATED MATERIALS

Capacity Outage Planning & Safe Work Approval.....OMM Book 3: Pipeline Facilities – Subject 01-02-03

De-Energizing or Switching of High Voltage Equipment....OMM Book 6: Equipment Maintenance – Subject 07-03-01

Drain Up & Linefill Procedure.....OMM Book 3: Pipeline Facilities - Subject 06-03-03

Inspection Standard.....GDL

Locking Out Nuclear Devices.....OMM Book 3: Pipeline Facilities – Subject 01-03-01

Re-Energizing High Voltage Equipment.....OMM Book 6: Equipment Maintenance – Subject 07-03-04

Safety Grounding High Voltage Equipment.....OMM Book 6: Equipment Maintenance - Subject 07-03-02

Verifying Double Isolation & Bleed.....OMM Book 3: Pipeline Facilities – Subject 06-03-43

## 9.0 STANDARD REVIEW

This standard must be reviewed by a designated owner and a technical review committee annually.

Technical reviews must solicit input from non-managerial field employees to ensure the effectiveness of the standard.

## 10.0 REFERENCES

### United States

American Petroleum Institute

American Society of Safety Engineers

- ANSI/ASSE Z244.1 – Control of Hazardous Energy – LOTO and Alternative Methods
- API 6D – Specification for Pipeline Valves

Code of Federal Regulations (CFR), Title 29 Labor

- Part 1910.147 Control of Hazardous Energy (LOTO)

---

**Canada**

Alberta Occupational Health and Safety Code

Canada Occupational Health and Safety Regulations SOR/86-304

- Part 13 – Tools and Machinery
- Part 15 Hazardous Occurrence Investigation, Recording and Reporting
- Part 8 Electrical Safety

Canada Labour Code, Part II:

Canadian Standards Association (CSA):

- CSA Z460 – Control of Hazardous Energy - Lockout and Other Methods

## 11.0 APPENDIX

### 11.1 APPENDIX A GENERAL LOCKOUT/TAGOUT PROCESS

Preparation:

1. The individual in charge of planning and coordinating the work shall prepare for shutdown, isolation and lockout (may or may not be the assigned Lockout Authority for the work) shall:
  - Identify for present hazardous energies:
    - a. Type,
    - b. Magnitude, and
    - c. Methods of control,
  - Identify and locate all potential energy sources to be isolated,
  - Review the scope of work,
  - Review drawings (P&IDs, Flow Diagrams, Single Line Diagrams, Switching Diagrams etc.), as applicable,
  - Visually inspect and walkdown equipment components being worked on to verify drawings,
  - Determine required LOTO equipment,
  - Obtain or develop safe shutdown and isolation procedures for machines/equipment to be LOTO and
  - Complete Part IA and Part IIA of the Energy Isolation Form,  
*Note: The individual in charge of planning and/or coordinating the work shall ensure a copy of the equipment shutdown and isolation procedures and Energy Isolation Form are forwarded to the CCO with each COPAS request. If a change is made to the procedures and/or EIF originally submitted with the COPAS request prior to the work commencing, the individual in charge of planning and coordinating the work shall ensure the revised version(s) are submitted to the CCO for review prior to the performing the shutdown and isolation.*
  - If the individual planning or coordinating the work is not the assigned lockout authority, the procedures and associated drawings of the equipment and systems to be shutdown, isolated and locked out must be reviewed with the assigned lockout authority. The assigned lockout authority must complete a walkdown of the equipment and systems to be shutdown, isolated and locked out prior to the work and will be accompanied by the individual planning and coordinating the work as required and requested.

2. The lockout authority or their designate shall complete required notifications immediately prior to execution of shutdown, isolation and lockout activities:

- Notify affected workers that a lockout will be in effect and explain reason for lockout, so that there is no attempt to re-energize equipment without proper approval. This includes notifying the CCO as appropriate (e.g., if equipment is in flow path that CCO is responsible for controlling or operating).

*Note: If the equipment shutdown and isolation procedures and/or Energy Isolation Form submitted to the CCO with a COPAS request are required to be changed at any time during the execution of the shutdown, isolation or work activities for any reason, the lockout authority or their designate must notify the CCO and submit the revised version(s) to the CCO for review prior to making such changes.*

Energy Isolation:

3. Company authorized personnel shutdown the equipment and systems:

- Shutdown operating equipment to be LOTO in accordance with the safe shutdown procedure. Refer to Energy Isolation Form, Open System Job Planning Template, or Electrical Switching & Work Clearance Form or OMM/ Site-specific procedures.

*Note: Ensure additional hazards are not created during shutdown.*

4. Company authorized personnel perform the isolation:

- Isolate equipment from its energy source by operating switch, valve or other energy-isolating device to appropriate position as identified within the isolation procedures and/or Energy Isolation Form.

*Note: Isolation may require multiple isolating devices to be operated*

Relieve, disconnect, restrain and/or render safe potentially hazardous stored or residual energy.

5. The Lockout Authority or their designate applies LOTO:

- Lock and tag isolating devices in a safe, secured position as identified within the isolation procedures and/or Energy Isolation Form to prevent accidental movement of device, and
- Complete Part II B of the Energy Isolation Form.

6. The Lockout Authority or their designate verifies the isolation:

- Verify (test) that lockout is effective by confirming that the system is under zero energy.

If re-accumulation of stored energy is possible, verification of energy isolation must be continued until servicing or maintenance work is completed or until hazard no longer exists.

*Note: Before verification tests, workers must be located in a safe area away from equipment being tested.*

*If zero energy is not feasible, regional management must review and approve work procedures.*

*Verification must be performed before starting work and at shift change.*

*Authorized workers must be confident the isolation has been verified before starting work and can request to see or perform a test at any time to confirm the isolation.*

7. Authorized workers apply LOTO:

- Each authorized worker personally performing work directly on the pipe or equipment being serviced/maintained will lockout and tag each isolation point or a lockbox, where used for group LOTO.

*Note: Workers cannot attach a personal LOTO device for another employee. Any affected worker (including support personnel and visitors) has the right to apply a lock.*

8. Authorized workers proceed with performing work on the equipment and systems:

- Proceed with work on the equipment and systems that have been LOTO.

## **11.2 APPENDIX B - GENERAL REMOVING ISOLATION AND RESTORING EQUIPMENT PROCESS**

### Lockout/Tagout Release:

1. Authorized workers remove their LOTO devices from each isolation point or the lockbox (whichever is utilized) upon completion of their work on the equipment and systems.
2. The lockout authority or designate inspects the work area to verify it is clear of tools and equipment, ensures personnel are accounted for and in a safe location, and that equipment worked on is ready for start-up (e.g., normal operating condition).
3. The lockout authority or designate notifies affected workers in the start-up area that equipment will be re-energized. This includes notifying the CCO as appropriate (e.g., if equipment is in flow path that CCO is responsible for controlling or operating).
4. The lockout authority or their designate removes the LOA locks / red lockset locks applied to isolation points.

### Re-energization:



- 
5. Company authorized personnel return isolating devices (e.g., switches, valves) to appropriate operating position for start-up and remove other safety controls installed for isolation.

*Note: For COPAS Requests, once the work is complete and the equipment or system is ready to be returned to service, the lockout authority or their designate must send a copy (scanned or digital photo) of the completed, signed and initialed Energy Isolation Form Part I & Part II to the CCO for use as a check to verify the flow path prior to start-up. Field personnel must be onsite a minimum 30 minutes prior to start up to ensure LOTO is reversed.*

6. If safe, restore energy to equipment.



**11.3 APPENDIX C – ENERGY ISOLATION FORM**

ENBRIDGE		Energy Isolation Form – Part I			ENB-FRM-0086
<b>A) PREPARATION</b>		<b>Safe Work Permit #</b>			
		COPAS Required?		<input type="checkbox"/> Yes COPAS # <input type="checkbox"/> N/A	
Scope of Work:				Lockset #:	
Date of Work:		Location:			
CCO Contact Name:		CCO Phone:		CCO Email:	
Lockout Authority (LOA):		Name – Day Shift:		Phone:	
		Name – Night Shift:		Phone:	
Form Prepared By:					
<b>Energy Isolation Plan</b>					
Energy Type(s) To Be Isolated		<input type="checkbox"/> Pressure <input type="checkbox"/> Electrical <input type="checkbox"/> Mechanical <input type="checkbox"/> Chemical <input type="checkbox"/> Biological <input type="checkbox"/> Thermal <input type="checkbox"/> Radiation <input type="checkbox"/> Other (specify):			
Energy Isolation Procedures		Energy Isolation Procedures Applicable to Work Available <input type="checkbox"/> Yes <input type="checkbox"/> No If yes, specify procedure to be used: <input type="checkbox"/> List Equipment to be Isolated on <b>Energy Isolation Form, Part IIA – Isolation Procedures/List</b> Piping System Isolation Method to be Used: <input type="checkbox"/> Not Applicable <input type="checkbox"/> Positive Isolation <input type="checkbox"/> Approved Alternate Isolation Vent/Drain Valves Required To Be Used for Work: <input type="checkbox"/> Yes <input type="checkbox"/> No If yes, name of person assigned if not LOA: Isolation Over Distance Required: <input type="checkbox"/> Yes <input type="checkbox"/> No If Yes, <b>complete section 'D'</b>			
Notification of De-Energization		Departments/Groups of Affected Personnel to be Notified:			<input type="checkbox"/> Notifications Complete
<b>B) ENERGY ISOLATION</b>					
Isolate Energy		<input type="checkbox"/> Complete isolation and record positions of energy isolating devices and application of locks on <b>Energy Isolation Form, Part IIB – Isolation</b>			
Verification of Isolation (e.g. bump test, voltage test, pressure confirmation)					
Zero-energy Isolation has been verified to ensure zero energy state: <input type="checkbox"/>					
Lockout Authority or Designate		Name - Day Shift:	Phone:	Date/Time:	
		Name - Night Shift:	Phone:	Date/Time:	
For Contractor Work - Person In Charge		Name – Day Shift:	Phone:	Date/Time:	
		Name – Night Shift:	Phone:	Date/Time:	
Transfer of Lockout Authority Required: <input type="checkbox"/> Yes <input type="checkbox"/> No If Yes, identify new Lockout Authority along with transfer and re-verification date/time					
New Lockout Authority		Name – Day Shift:	Phone:	Date/Time:	
		Name – Night Shift:	Phone:	Date/Time:	
Transfer of Contractor Person in Charge Required: <input type="checkbox"/> Yes <input type="checkbox"/> No If Yes, identify new Contractor Person in Charge along with transfer and re-verification date/time					
Contractor - New Person in Charge		Name - Day Shift:	Phone:	Date/Time:	
		Name – Night Shift:	Phone:	Date/Time:	
<b>C) ENERGY ISOLATION REMOVAL</b>					
Work Completion		Is all work on equipment complete, personnel and tools accounted for, and equipment has been restored to normal operating condition? <input type="checkbox"/> Yes <input type="checkbox"/> No If No, what measures have been taken?			
Isolation Removal		<input type="checkbox"/> Remove locks and other safety controls installed for isolation, return equipment to position required for start-up, and record on the <b>Energy Isolation Form, Part IIC – Isolation Removal</b>			
Notification of Re-Energization		<input type="checkbox"/> Departments/Groups of Affected Personnel Have Been Notified of Re-Energization			
Final Verification of Isolation Removal – All Locks Removed and Energy Isolating Devices Are Placed in Proper Position					
Lockout Authority (or designate)		Name:		Date/Time:	
For Contractor Work - Person in Charge		Name:		Date/Time:	
<b>D) ISOLATION OVER DISTANCE (if required)</b>					
Preparation					
Energy Isolation Procedures		Site #1	Site #2	Site #3	
		Location of Remote Equipment Isolation			
		Name/Phone # of Worker Responsible for Remote Isolation			
		Method Established to Verify Remote Isolation			
Energy Isolation		Name – Site 1:	Phone:	Date/Time:	
		Name – Site 2:	Phone:	Date/Time:	
		Name – Site 3:	Phone:	Date/Time:	



Part IA – Isolation Procedure/List	#	Steps Used to shutdown/isolate or List of Equipment to shutdown/isolate if Isolation Procedure documented elsewhere	Part IIB – Isolation						Part IIC – Isolation Removal				Comments (e.g., isolation verification method, location of the isolation point- MCC, ESB, etc.)	
			Equipment Status			Isolation/Lockout Complete			Locks Removed		Equipment Status As Left			
			Prior to Isolation	During Isolation	Isolation/Lockout Complete	Electrical	Mechanical	Elect	Mech	Elect	Mech			
E.G. Valve 12345	Eng (O/C)	Mech (A/C/N)	Lock #	Eng (O/C)	Mech (A/C/N)	Lock #	Eng (O/C)	Mech (A/C/N)	Lock #	Eng (O/C)	Mech (A/C/N)	Lock #		
1.														Verified Isolation by pushing start button
2.														
3.														
4.														
5.														
6.														
7.														
8.														
9.														
10.														
11.														
12.														
13.														
14.														
15.														
16.														
17.														
18.														



**Energy Isolation Form – PART II**

Legend  
Electrical: D – De-energized E – Energized  
Switch: A – Auto/Remote L – Local/MCC X – Off  
Mechanical: O – Open O – Closed

ENB-FRM-0086

**11.4 APPENDIX D – LOCK REMOVAL AUTHORIZATION FORM**



**Lock Removal Authorization Form**

Unauthorized removal of a personal or equipment lock by anyone other than the person it belongs to, without proper authorization, will be subject to disciplinary action in accordance with the lifesaving rules.  
The intent of this form is to ensure that the necessary steps have been taken before lock removal in order to safeguard personnel. This form addresses both personal and equipment locks.

**Personal Lock Removal**

Date:		Lock Location:	
Lock Owner Name:			
Lock Removal Reason:			
Machinery, Equipment or System Description:			
Individual Requesting Removal:		Phone #:	
Lock Owner Acknowledgement (to be completed prior to returning to work)			

**NOTE: The following 4 questions must be answered:**

1	Was a search of the job site conducted to ensure that the worker is no longer there?	<input type="checkbox"/> Yes	Must be a "Yes"	A thorough search must be completed.
2	Was the lock owner able to be contacted? (Attempts must be made)	<input type="checkbox"/> Yes	<input type="checkbox"/> No	Phone #: Time: Enter time of verbal authorization and initial
3	Did the lock owner give verbal permission to remove the lock?	<input type="checkbox"/> Yes	<input type="checkbox"/> No	Time: Initial: Enter time of verbal authorization and initial
4	LOA(Name): Did the LOA give permission to remove the lock?	<input type="checkbox"/> Yes	Must be a "Yes"	Time: Initial: Enter time of verbal authorization and initial

**Equipment Lock Removal**

Date:		Lock Location:	
Lock Removal Reason:			
Individual Requesting Removal:		Phone #:	

**NOTE: The following 2 questions must be answered:**

1	Is the isolation ready to be removed?	<input type="checkbox"/> Yes	Must be a "Yes"	All permits signed off
2	Supervisor (Name): Did the Supervisor give permission to remove the lock?	<input type="checkbox"/> Yes	Must be a "Yes"	Enter time of verbal authorization and initial Time: Initial: Enter time of verbal authorization and initial

LOA keeps the completed Lock Removal Authorization Form for 2 years and sends a notification to the Regional Health and Safety Advisor and to the Individual with the removed lock

## **11.5 APPENDIX E – ISOLATION OVER DISTANCE**

In some cases, it may not be reasonably practicable to use a personal or group lock out process. To maintain worker safety, normal personal or group lock out practices may need to be adapted or modified into what is referred to as isolation over distance process. This process is implemented and coordinated by the LOA.

A reason for choosing to use isolation over distance may be due to the equipment and/or pipeline occupying such a large area (or occupying multiple areas) that it becomes impractical for the LOA to personally secure all energy isolation devices. Some of the devices when isolating over distance may need to be isolated and secured by another worker (e.g., control room operator, authorized worker at another field location) due to the distance between the work area and the isolation devices.

A copy of the Energy Isolation Form must be forwarded to the remote site authorized worker prior to isolation and lockout. The LOA must document and verify secured and effective isolation through direct communication with the worker completing the isolation with lockout locks at the remote site.

The authorized worker completing the isolation at the remote site must maintain control of the key(s). Alternatively, the keys to the locks can be brought to the location where work is being performed and added and secured in a lockbox at the work area.

The LOA can begin coordinating the return to operation process only when all personal locks have been removed by the workers at the work area and the remote site(s).

For Alberta Regulated Assets: Isolation over distances must have a written alternative isolation procedure approved and authenticated by a qualified engineer as per EP-CENG-OE-P-0006 – Professional Engineering and Geoscience Authentication.

## **11.6 APPENDIX F CAR SEALS**

Car seals and car seal tags are used to ensure valves identified as essential to the operation of safety systems are secured in a prescribed position (open or closed) as per the latest controlled version of the P& ID drawing. Identification of valves which require car seals must be done in consultation with the Process Engineering Department. The removal and re-application of car seals is required to be documented on the Energy Isolation Form by indicating the status of the car seal prior to isolation and prior to restart (e.g., CSO – Car Seal Open; CSC – Car Seal Closed).



**CHANGE LOG**

Section	Version 3.1	Version 3.2
Entire document		Clerical corrections including spelling, grammar, and document names.

<End of Document>



---

# Standard

---

## Electrical Safety

---

**Effective Date:** 2019-10-31  
**Version #:** 5.0  
**Version Date:** 2024-04-30

---



This page intentionally left blank





**Document Version Register**

Version Number	Version Date	Approved By	Section Number and Title	Details of Version
1.0	2019-03-30	Sean Evans	Whole Document (New Standard)	This is the new H&S standard that was developed as part of the LP/MP Safety Manual Transition Project
2.0	2019-09-20	Sean Evans	Various revisions throughout.	Changes made as a result of comments received during MOC and following further review by ESAT. See Change Log.
2.1	2020-06-01	Sean Evans	2.0	Alignment with Contractor Safety Specifications
3.0	2021-06-01	Murray Evenson	Various revisions throughout.	Changes from the Energized Electrical Work Permit Working Group that have been approved by ESAT.
4.0	2022-07-19	Murray Evenson	6.4, Appendix D & K	Updates to section 6.4, revisions to appendix D and added new appendix K (see change log for details)
5.0	2024-04-30	Troy Croft	Most sections affected.	Full review of document for LP and GTM adoption, and synchronization with current editions of NFPA 70E and CSA Z462. See change log.



---

This page intentionally left blank



## Table of Contents

1.0	Purpose .....	3
2.0	Scope .....	3
3.0	Related Documents .....	3
4.0	Definitions & Acronyms .....	4
5.0	Roles & Responsibilities .....	11
6.0	Electrical Safe Work Requirements .....	17
6.1	Normal and Abnormal Electrical Installations .....	17
6.2	Electrical Hazards & Controls .....	18
6.3	Worker Qualifications And Electrical Work Tasks .....	21
6.4	Electrical Safe Work Requirements .....	22
6.4.1	Establishing an Electrically Safe Work Condition .....	23
6.4.2	Energized Electrical Work .....	25
6.4.3	Energized Electrical Work Permit .....	26
6.4.4	Arc Flash and Shock Hazard Risk Assessment .....	28
6.4.5	Arc Flash & Shock Approach Boundaries .....	32
6.4.6	Electrical Equipment Areas, Electrical Work Zones, and access restrictions for electrical buildings and areas .....	32
6.5	Electrical-Specific PPE, Tools and Equipment .....	35
6.5.1	Electrical Personal Protective Equipment .....	36
6.5.2	Electrical Tools & Equipment .....	38
6.6	Energized Electrical Safe Work Practices .....	39
6.7	High Voltage Substations .....	40
6.7.1	High Voltage Substation Pre-Job Planning Requirements: .....	40
6.7.2	Use of the Enbridge Electrical Switching and Work Clearance Form .....	41
6.8	Working Alone .....	46
6.9	Look-alike Equipment .....	46
6.10	Temporary Power Systems .....	46
6.11	Electrical Safety Program Assessment .....	48
6.12	Post Service Equipment Re-Energization and Post Fault Re-Energization Procedure .....	48
6.13	Electrical Events and Reporting .....	48
6.14	Electrical Emergency Response .....	49
6.14.1	Methods of Release .....	50



---

7.0	Training Requirements .....	50
8.0	Standard Review .....	50
9.0	References .....	51
10.0	Appendix.....	52
10.1	Appendix A – Electrical Work Tasks By Qualification Category.....	52
10.2	Appendix B – Temporary Protective Grounding Sign .....	61
10.3	Appendix C – Electrical Switching and Work Clearance Form .....	62
10.4	Appendix D – Electrical Work Risk Register Summary.....	64
10.5	Appendix E – Energized Electrical Work Permit .....	68
10.6	Appendix F – Energized Electrical Work Permit Process .....	69
10.7	Appendix G – Temporary Power Certificate.....	70
10.8	Appendix H – Power Utility Information Form .....	73
10.9	Appendix I – Enbridge Electrical Safety Tools & Equipment.....	74
10.9.1	Temporary Protective Grounds (TPGs).....	74
10.9.2	High Voltage Detectors and Testers.....	77
10.9.3	Low Voltage Digital Multi-Meters and Miscellaneous Electrical Meters .....	78
10.9.4	Hot Sticks (Live-line Tools).....	80
10.9.5	Static Discharge Stick.....	81
10.9.6	Insulated Hand Tools.....	82
10.9.7	Records.....	82
10.10	Appendix J – Energized Electrical Safe Work Practices .....	83
10.10.1	General Substation-Related Safe Work Tasks.....	83
10.11	Appendix K – Electrical Hazard for DC Systems and Remote Valve Sites.....	84
11.0	Change Log .....	85

## 1.0 PURPOSE

The purpose of the Liquids Pipelines (LP) Electrical Safety Standard (ESS) is to establish safe operating and maintenance practices and procedures when working with energized electrical equipment and systems. The intent is to prevent exposure to, and protect the worker from, electrical shock and arc flash hazards.

## 2.0 SCOPE

This Standard applies to all employees performing electrical work tasks on electrical power distribution and utilization equipment at Enbridge operating and other worksite locations (including office locations independent of operating facilities). This includes tasks involving operation, testing, and maintenance of electrical isolating devices. All existing, brownfield, and greenfield worksites and projects are within the scope of this Standard.

Contractors and subcontractors shall comply with Enbridge health and safety requirements set out in this standard, as articulated within applicable Enbridge contractor safety specifications. If a contractor or subcontractor has a health and safety standard or policy materially different from Enbridge's, the contractor/subcontractor shall follow the most stringent requirement. Contractors and subcontractors are still obligated to meet the requirements of all applicable laws related to this Standard.

In the event that a contractor's or subcontractor's standard exceeds the requirements of this Standard, Enbridge may, in its sole discretion, choose to utilize the contractor's or subcontractor's standard for any given contract or work order.

For LP only, this Standard does not apply to:

- non-electrical work tasks performed in proximity to overhead power lines, buss, and buried power lines (see the LP *Safe Limits of Approach & Entry – Power Lines & Substations* Standard for requirements associated with these activities),
- use of portable cord-and-plug-connected electrical equipment, appliances, and cord sets (extension cords) to accomplish assigned electrical and non-electrical work tasks (see the LP *Tools and Equipment* Standard for requirements associated with these activities).

## 3.0 RELATED DOCUMENTS

Type of Policy or Procedure	LP Document	GTM Document
Control of Hazardous Energy or Lockout/Tagout	Control of Hazardous Energy Standard	Health and Safety Manual Lockout/Tagout Section 4.29
Procedures for investigating, testing, and returning	Post Fault Return to Service Guideline	Health and Safety Manual Lockout/Tagout Section 4.29

Type of Policy or Procedure	LP Document	GTM Document
electrical equipment to service after electrical faults		
Energized Electrical Work Task Risk Assessment	Energized Electrical Work Task Risk Register	Health and Safety Manual Lockout/Tagout Section 4.29
Ground Disturbance	Ground Disturbance Standard	Health and Safety Manual for Excavation and Trenching Safety – Section 4.13
Hazard Assessment, Elimination, and Control	Hazard Assessment, Elimination, and Control Standard (LP Version)	Hazard Assessment, Elimination, and Control Standard (GTM Version)
Event Analysis	Event Analysis Process	Health and Safety Manual Event Analysis Section 11.1
Personal Protective Equipment	Personal Protective Equipment Standard	Health and Safety Manual (various PPE sections)
Safe Limits of Approach to Power Lines	Safe Limits of Approach & Entry – Power Lines & Substations Standard	Health and Safety Manual (safe limits of approach to power lines sections)
Safe Work Permits	Safe Work Permit and Work Authorization Standard (LP Version)	Safe Work Permit and Work Authorization Standard (GTM Version)
Tools/Equipment Safe Work Requirements	Tools and Equipment Standard	Health and Safety Manual (various tools and equipment related sections).
Working Alone	Working Alone Safety Standard	Health and Safety Manual Section 4.47

## 4.0 DEFINITIONS & ACRONYMS

*Abnormal Operating Conditions* - Where the equipment does not meet one or more of the requirements of *Normal Operating Conditions*. See definition of *Normal Operating Conditions*.

AC – Alternating Current

*AED* – Automated External Defibrillator

*ANSI* – American National Standards Institute

*Approved Electrical Test Equipment* - For the US, is tested and certified to the applicable UL standards by a Nationally Recognized Testing Laboratory and shall bear a certification marking per the standard. For Canada, the approved test equipment shall bear a CSA label, UL<sub>C</sub> label or a label of a certification testing body accredited by the Standards Council of Canada.

*Arcing Fault Current* - A fault current flowing through an electrical arc plasma, also called arc fault current and arc current.

*Arc Blast* - Associated with the release of pressure as a result of arcing fault current.

*Arc Flash Hazard* - A dangerous condition associated with the release of energy caused by an electric arc.

**Note:** An arc flash hazard can exist when energized electrical conductors or circuit parts are exposed or are within equipment in a guarded or enclosed condition if a person is interacting with the equipment in a manner that could cause an electric arc. Under normal operating conditions, enclosed energized equipment that has been properly installed and maintained is not likely to pose an arc flash hazard.

*Arc Flash Risk Assessment (AFRA)* - A study investigating a worker's potential exposure to arc flash energy, conducted for the purpose of injury prevention and the determination of safe work practices, Arc Flash Boundary (AFB), and the appropriate levels of personal protective equipment. See also *Incident Energy Analysis*.

*Arc Flash Boundary (AFB)* – When an arc flash hazard exists, an approach limit at a distance from energized electrical conductors or circuit parts within which a person could receive a second-degree burn (e.g., 1.2 cal/cm<sup>2</sup> or 5.0 joules/cm<sup>2</sup> of incident energy exposure).

*Arc Flash PPE Category* - A method of completing an arc flash risk assessment that uses electrical equipment type, voltage, and energized work task descriptions with an associated maximum short circuit current and maximum fault clearing time to determine arc flash protective clothing requirements.

*Arc Flash Suit* - A complete arc-rated clothing system that covers the entire body except for the hands and feet. It includes bib-overall pants, a coat, and a bee-keeper style hood fitted with a face shield. It is recommended that the hood includes an integral cooling fan, LED lamp, and rescue tether.

*Arc Rating (AR)* - The value attributed to materials that describes their performance on exposure to an electrical arc discharge. The arc rating is expressed in cal/cm<sup>2</sup> or joules/cm<sup>2</sup> and is derived from the determined value of the Arc Thermal Performance Value (ATPV) or energy of breakopen threshold energy (E<sub>BT</sub>) (if a material system exhibits a breakopen response below the ATPV value).

**Note:** 'Breakopen' is a material response evidenced by the formation of one or more holes with an area of 16 mm<sup>2</sup> (0.5 in<sup>2</sup>) or an opening of 25 mm (1.0 in) in any dimension in the

innermost layer of flame-resistant material that can allow flame to pass through the material.

*Arc Resistant Switchgear* - Switchgear designed and built to provide maximum safety in the event of an Internal Arcing Fault. Designed to withstand the high pressures created by an arcing event and directs the internally released energy away from the worker. This provides a high degree of protection to personnel in the vicinity of the switchgear.

*Arc Thermal Performance Value (ATPV)* - Defined in *ASTM F1959* as the incident energy on a material or a multilayer system of materials that results in 50% likelihood that sufficient heat transfer through the tested specimen is predicted to cause the onset of a second-degree skin burn injury based on the Stoll curve.

*AEW* – Associate Electrical Worker

*ASTM* – American Society for Testing and Materials

*Authority Having Jurisdiction* - An organization, office, or individual responsible for enforcing regulations or the requirements of a code or Standard, or for approving equipment, materials, an installation, or a procedure.

*Authorized (see “Restricted Electrical Area”)* - A worker is authorized (to be in a restricted electrical area) if they have a requirement to be in a restricted electrical area in order to perform a task or tasks of an electrical nature; and if they have the necessary qualifications and competencies necessary to identify and mitigate the hazards associated with the task or tasks to be performed.

*Balaclava (sock hood)* – An arc-rated flame-resistant hood that protects the neck and head, except for the area of the eyes and nose.

*Blind Reaching (or Reaching Blindly)* – Placing a body part, usually a hand or finger, into an area that is not directly visible or not visible due to inadequate lighting.

*Breakopen Threshold Energy ( $E_{BT}$ )* – The incident energy on a material or material system that results in a 50% likelihood of breakopen. When ATPV ratings cannot be used due to fabric breakopen, the  $E_{BT}$  rating is applied.  $E_{BT}$  is defined in *ASTM F 1959* standard and consists of the average of the five highest incident energy levels that did not generate a second-degree burn exposure level (1.2 cal/cm<sup>2</sup>) and did not cause fabric to breakopen.

*Circuit Breaker (CB)* – A device designed to open and close a circuit by non-automatic means and to open the circuit automatically on a predetermined overcurrent without damage to itself when properly applied within its ratings.

*Competent Worker* – Based on validation, a worker who has suitable qualifications, training, knowledge, and experience to undertake specific work tasks.

*Conductor* - A wire, cable, or other form of metal installed for the purpose of conveying electric current from one piece of electrical equipment to another or to ground.

*CSA* – Canadian Standards Association



*DC* – Direct Current

*De-energized* - Free from any electrical connection to a source of potential difference and from electrical charge; not having a potential different from that of the earth.

*Direct Supervision* - Means that a 'Qualified Electrical Worker' is working with the 'trainee' in the same location and is available for direct communication, not by remote means.

*Disconnecting Means* - A device, group of devices or other means by which the conductors of a circuit can be disconnected from their supply source.

*EESAT* – Enbridge Electrical Safety Advisory Team

*Electrical Hazard* - A dangerous condition such that contact, or equipment failure can result in electric shock, arc flash burn, thermal burn, or blast. See section 6.3 for further information on electrical shock, arc flash and arc blast hazards.

**Note:** Power supplies approved as extra-low voltage, extra-low voltage lighting systems and similar sources are examples of circuits or systems that are not considered an electrical hazard.

*Electrical Equipment Areas (EEA's)* - Permanently demarcated areas around the electrical equipment that allow for ongoing safe electrical equipment operation and other work tasks. They are intended to keep the area around the electrical equipment free from combustible items, tripping hazards and other obstructions, and they allow for the safe performance of electrical work tasks. They also allow the non-electrical equipment, materials, and various work activities to be performed safely without getting too close to the electrical equipment.

*Electrically Safe Work Condition* - A state in which an electrical conductor or circuit part has been disconnected from energized parts, locked out in accordance with established standards, tested to ensure the absence of voltage, and grounded (if grounding is deemed necessary).

*ESW* – Electrical Safety Watch.

*Energized* - Electrically connected to or having a source of voltage.

*Energized Electrical Work Permit (EEWP)* - A written document that ensures that a work task requiring increased exposure to shock and/or arc flash injury provides notification to the equipment owner, the People Leader and the worker(s) that the risk of injury is increased. It provides the opportunity to re-evaluate the necessity for the increased risk of injury.

*Electrical Work Zones (EWZ's)* - Used to temporarily establish safe spaces around work areas when performing energized electrical work tasks on electrical equipment.

*Energized Parts* - Electrically energized conductive components.

*ESS* – Electrical Safety Standard

*Exposed* - (as applied to energized electrical conductors or circuit parts) Capable of being inadvertently touched or approached nearer than a safe distance by a person. This term is applied to electrical conductors or circuit parts that are not suitably guarded, isolated, or insulated.

*GOI* – Guarantee of Isolation

*Ground-Fault Circuit Interrupter (GFCI)* - Reliable devices that limit fault current and prevent electrocutions. They are intended for the protection of personnel and function to de-energize a circuit or portion thereof within an established period of time when a current to ground exceeds the values established.

*GTM* – Gas Transmission and Midstream

*Guarded* - Covered, shielded, fenced, enclosed, or otherwise protected by suitable covers, casings, barriers, rails, screens, mats, or platforms to remove the likelihood of approach or contact by persons or objects to a point of danger.

*High Voltage (HV)* - For the purpose of this Standard, high voltage is greater than 1000 VAC and 1060 VDC Canada (CEC Part 1 2021 Definitions), 1000 V (AC or DC) USA (NEC 490-2)

*Note that there are various other definitions used in different industry standards such as ANSI, IEEE, and NFPA, however the definitions used here are contextually consistent with the terms high and low voltage used in NFPA 70E and CSA Z462. Neither of these standards define low or high voltage.*

*IEEE* – Institute of Electrical and Electronics Engineers

*Incident Energy (IE)* - The amount of energy impressed on a surface, a certain distance from the source, generated during an electrical arc event. Incident energy is measured in calories/cm<sup>2</sup> or joules/cm<sup>2</sup>.

*Incident Energy Analysis* - The determined and documented incident energy exposure of the worker in cal/cm<sup>2</sup>. The exposure level shall be based on the working distance of the worker's face and chest areas from a prospective arc source for the task to be performed. Arc-Rated clothing and personal protective equipment is selected on the basis of the Incident Energy exposure associated with the specific task. Because Incident Energy increases as the distance from the Arc Flash decreases, additional personal protective equipment is required for any parts of the body that are closer than the distance at which the incident energy was determined. Included in the risk assessment is the calculation of the applicable Arc Flash Boundary. See also *Arc Flash Risk Assessment*.

*Insulated* - Separated from other conducting surfaces by a dielectric barrier (including air space) offering a high resistance to the passage of current.

*IR* – Infrared (thermography)

*Isolated (from power sources)* - Secure physical separation or blocking with non-conductive material sufficient to ensure equipment cannot be energized by identified power sources.

*Limited Approach Boundary, Shock* - An approach limit at a distance from an exposed energized electrical conductor or circuit part within which a shock hazard exists.

*Lockout* - Placement of a lock on an energy-isolating device in accordance with an established procedure, thereby indicating that the energy-isolating device is not to be operated until removal of the lock or in accordance with an established procedure.

*Lockout Device* - A mechanical means of locking that uses an individually keyed lock to secure an energy-isolating device in a position that prevents energization of a machine, equipment, or a process.

*Low Voltage (LV)* – For the purpose of this Standard, low voltage is less than or equal to 1000 VAC; 1060 VDC (Canada) and 1000 V (AC or DC) (USA).

*LP* – Liquids Pipelines

*Minimum Approach Distance* - The closest distance a qualified employee is permitted to approach either an energized or a grounded object as applicable for the work method being used (per US National Electrical Safety Code).

*MOC* – Management of Change

*NFPA* – National Fire Protection Association

*NEW* – Non-Electrical Worker

*Normal Operating Conditions* - Where the equipment is: properly installed (in accordance with applicable codes, standards, certifications, and the local Authority Having Jurisdiction); properly maintained; is used in accordance with instructions included in the listing and labeling (e.g., Canadian Electrical Code, Part II Standard, in Canada and National Electrical Code in the USA) and in accordance with the manufacturer's instructions; used with all equipment doors closed and secured; covers are in place and secured; and there is no evidence of impending failure. See also definition of "*Abnormal Operating Conditions*".

*Operator-in-Charge (OIC)* - An individual that is knowledgeable and experienced in the operation of high voltage substations who has been assigned the responsibility for the operation of the electrical system. Has authority within their jurisdiction to approve or reject work performed on the electrical system. Is responsible for maintaining the requirements of the Interconnection Agreement if one is in place with other electrical systems.

*Overcurrent* - A current in excess of the rated current of equipment or the ampacity of a conductor. It can result from an overload, short circuit, or ground fault.

*Overload* - Operation of equipment in excess of normal, full-load rating, or of a conductor in excess of rated ampacity that, when it persists for a sufficient length of time, will cause damage or dangerous overheating.

*PLC* – Programmable Logic Controller

*PPE* – Personal Protective Equipment

*QEW* – Qualified Electrical Worker

*QEWHV* – Qualified Electrical Worker with High Voltage training

*Qualified Instrumentation Worker (QIW)* – Instrumentation Technicians

*QOW* – Qualified Operations Worker

*Restricted Approach Boundary, Shock* – An approach limit at a distance from an exposed energized electrical conductor or circuit part within which there is an increased likelihood of shock, due to electrical arc over combined with inadvertent movement, for personnel working in close proximity to the energized electrical conductor or circuit part.

*Restricted Electrical Area (see “Authorized”)* – For the purposes of authorization, a restricted electrical area is a location where workers need to be authorized in order to access or enter. It could be an electrical room, electrical building, electrical equipment, electrical substation, electrical work or testing area, etc.).

**Note:** Restricted electrical areas shall be identified as “Authorized Personnel Only” through exterior signage.

*SLD* – Single Line Diagram

*SME* – Subject Matter Expert

*TQW* – Task Qualified Worker

*Temporary Protective Grounds (TPG’s)* – Devices installed temporarily on de-energized electric power circuits for the purpose of potential equalization and to conduct a short circuit current for a specified duration (time).

*UL* – Underwriter’s Laboratories

*UPS* – Uninterruptible Power Supply

*UV* – Ultraviolet

*VFD* – Variable Frequency Drive

*Voltage Class* - A voltage designation (low, medium, or high) assigned to electrical equipment used within industrial and commercial power systems in accordance with recommended IEEE standards. These designations are used by Enbridge for the purpose of classifying voltage ranges of equipment for design and maintenance purposes as established within Enbridge’s Engineering Standards and Job Plans (for LP only – refer to OMM Book 6). They are not used for determining worker safety requirements.

Low Voltage Equipment -  $\leq 1000V$

Medium Voltage Equipment –  $> 1000V$  to  $\leq 100kV$

High Voltage Equipment –  $> 100kV$

*Working Distance* – The dimension between the possible arc point and the face and torso of the worker positioned in place to perform the assigned task. Default working distances are provided in IEEE 1584 as 18” for low voltage equipment, 24” for low voltage switchgear and 36” for high voltage switchgear (e.g., 4.16 kV, 13.8 kV, 25 kV, etc.).

*Working On (energized electrical conductors or circuit parts)* – Coming in contact with energized electrical conductors or circuit parts with the hands, feet, or other body parts, with tools, probes, or with test equipment, regardless of the personal protective equipment a person is wearing. There are two categories of “Working On”:

*Diagnostic (testing)* – Taking readings or measurements of electrical equipment with approved test equipment that does not require making any physical change to the equipment.

*Repair* – Any physical alteration of electrical equipment such as making or tightening connections, removing, or replacing components, etc.

## 5.0 ROLES & RESPONSIBILITIES

Regional Management shall:

- Ensure that capital and operating budgets include funding for electrically safe installations, approved electrical PPE, tools and equipment, electrical safety training and other funding as required for implementation of the ESS.
- Ensure compliance with the requirements of this standard and the ongoing effectiveness of its implementation through completion of periodic assessments and auditing.
- Ensure changes to electrical installations, programs, standards, and practices are effectively managed through use of an approved Management of Change (MOC) process.
- Ensure electrical events are analyzed and corrective and preventative actions arising from such analyses are followed up on as required.
- Ensure Area Supervisors and People Leaders attend electrical safety training.
- Designate individual(s) as the Operator(s)-in-Charge of high voltage substations owned by Enbridge in accordance with the requirements of Utility Interconnection Agreements established with Utility Operators.

Engineering (LP, GTM, and Projects engineering groups) shall:

- Ensure power system design meets Enbridge minimum requirements as outlined within the Engineering Standards and embeds safety-by-design elements.

- Manage or complete the implementation of Arc Flash Incident Energy Analysis and ensure that Arc Flash Risk Assessment data from the Analysis or the Arc Flash PPE Category 'Table Method' is validated and provided for reference by QEWs. This may be in the form of detailed Arc Flash and Shock Warning Equipment Labels or Arc Flash Incident Energy (Engineering Study) Results Tables. This data may also be included in the Computerized Maintenance Management System (CMMS).
- Ensure that detailed Arc Flash & Shock Warning or Danger Equipment Labels used comply with the requirements of CSA Z462 (CAN) or NFPA 70E (USA), and applicable Enbridge specifications and standards.
- Provide technical support to workers performing electrical work tasks by validating Engineering Data, Incident Energy, and Arc Flash Boundary calculations. Provide technical support, and possibly in-depth analysis, for facilities or operations that have unique or special configurations, or in which unusual hazards are encountered. Provide support for field personnel on interpretation, application, and data collection for use of the Category Table Method in CSA Z462 and NFPA 70E.
- Review, recommend and/or implement Incident Energy reduction mitigation strategies in order to reduce arc flash incident energy exposures to as low as reasonably practicable.
- For new facilities or additions, supervise the engineering consultant to ensure they follow the requirements of the Engineering Standards in their power system studies and incident energy analysis (e.g., target engineered design maximum working incident energy level of 40 cal/cm<sup>2</sup>, target engineered design mitigation to achieve lower than 12 cal/cm<sup>2</sup> incident energy level).
- Assist Operations and Maintenance departments in reviewing electrical equipment maintenance requirements for sustainable safety and reliability.
- Initiate MOCs and/or participate as a stakeholder in the review and approval of MOCs related to the electrical power distribution system.
- Lead or participate in analysis of electrical events and in development and resolution of corrective and preventative actions arising from such analyses as assigned by Management.
- Ensure electrical Single Line Diagrams (SLDs) are accurate, meet the requirements of the drawing standards, and are available to the field as per applicable electrical installation code(s).

Enbridge Electrical Safety Advisory Team (EESAT) shall:

- Provide Subject Matter Expertise to Safety Shared Services to assist in developing and maintaining the Electrical Safety Standard and support its implementation and ongoing use in Enbridge.

- Provide input to standard owners on electrical equipment and system design, procurement, construction, and installation standards as required for safe electrical installations.
- Provide input into testing, inspection and maintenance requirements required to maintain electrical installations in a safe operating condition.
- Identify and specify electrical specific PPE, tools, and equipment for use where required.
- Develop and maintain electrical safe work practices and associated technical support resources to assist with implementation of electrical specific PPE, tools, and equipment.
- Provide technical support and assistance as required to address broad electrical safety issues and concerns or issues and concerns that cannot be otherwise resolved locally.
- Identify electrical safety training and re-training requirements, and support development and implementation of electrical safety training programs.
- Monitor and analyze electrical event trends and identify any necessary follow-up actions.
- Provide electrical safety SME advisement in support of development, performance, and follow up corrective work from reviews and audits.
- Prepare and issue electrical safety related advisories and bulletins to the organization.
- Advance electrical safety at Enbridge through development, review, and evaluation of new technologies, codes, regulations, procedures, practices, techniques, etc. Ensure representation and/or participation at key conferences and on key industry committees to provide effective influence on Enbridge's behalf and to stay abreast of latest developments.
- Further communicate and distribute electrical safety related information as applicable across respective areas of representation (e.g., via mini-EESAT, Safety Newsletter, etc.).
- Track electrical safety achievements, needs, and issues. Develop and track Key Performance Indicators and report to stakeholders.

Energy Management shall:

- Steward development and maintenance of electrical utility related interconnection agreements and associated safe operating agreements.

People Leaders shall:

- Ensure workers are aware of the electrical hazards of arc flash and shock and that they assist in the assessment and mitigation of the risk of specific energized electrical work tasks to as low as reasonably practicable in accordance with the requirements of this standard.
- Ensure that workers (including Qualified Electrical Workers and other Task Qualified Workers) who are exposed to energized electrical conductors or circuit parts are trained, qualified, and authorized to undertake the work task, and that documentation is available supporting their completed training, proper qualifications, and authorization to perform the work task.
- Ensure that workers who need to work around or with energized electrical equipment (Non-Electrical Workers and Qualified Operations Workers) without direct exposure to energized components or circuit parts, are trained, qualified, and authorized to undertake their work tasks, and that documentation is available supporting their completed training, proper qualifications, and authorization to perform the work task.
- Ensure proper authorization for entry into “restricted electrical areas” (see definition) by all personnel and visitors.
- Ensure competency of the workers they supervise is validated in accordance with the applicable technical competency program.
- Ensure that approved and appropriate electrical specific PPE, tools, and equipment are available, tested/certified, inspected, maintained, and used where applicable and as required for the work, and that documentation is maintained, as applicable, for the specific PPE, tools, and equipment.
- Monitor worker compliance with the requirements of this standard by inspecting and observing work activities and completing documentation reviews.
- Review and address issues, concerns and proposed changes brought forward by workers and initiate an approved Management of Change (MOC) process where required.
- Authorize completion of energized electrical work tasks, where justified, in accordance with the requirements of this standard.
- Lead or support analysis of electrical events including electrical safety related near misses as assigned by Management and ensure timely completion of assigned corrective and preventative actions.



Workers shall:

- Complete required electrical safety and technical training as assigned.
- Identify and understand the electrical hazards of arc flash and shock associated with assigned work tasks along with all other hazards, assess the risk of such tasks, and implement effective preventive and protective control measures as per the hierarchy of risk control methods to eliminate or reduce the risk to as low as reasonably practicable.
- Only perform electrical work tasks for which they are trained, qualified, and authorized to undertake.
- Comply with the requirements of this standard and all applicable Codes and Regulations.
- Test, inspect, maintain and use approved electrical specific PPE, tools and equipment as required for the work (see Appendix I).
- Avoid performing energized electrical work unless otherwise justified and approved in accordance with the requirements of this standard.
- Communicate any issues, concerns or changes required to electrical installations, programs, standards, and practices identified to the respective People Leader for review and follow-up as required.
- Report all events including near misses immediately to their People Leader and actively participate and cooperate in the analysis of such incidents as required.

Safety Shared Services shall:

- Provide overall corporate governance, stewardship, and on-going maintenance of this Standard.
- Ensure that various Enbridge corporate processes are put in place to support the successful implementation of this Standard.
- Provide and support analysis processes for use in analyzing, reporting, and follow-up corrective work for electrical events.
- Together with Regulatory and other appropriate stakeholders, ensure that all electrical events are reported to applicable jurisdictional authorities, and that event analyses and corrective work are completed.
- Be responsible for the maintenance and continuous improvement of this standard.
- Assist in the selection of appropriate electrical code compliant training programs for all levels of qualified employees.

- Assist in the selection of appropriate safety training programs for all levels of qualified employees.
- Ensure that an internal (field) Electrical Safety Program Assessment is performed on an annual basis to measure performance of the Electrical Safety Standard and compliance with regulatory requirements. Coordinate this assessment and/or delegate this responsibility to appropriate portions of the organization and electrical safety subject matter experts.
- Ensure that an overall Electrical Safety Program Assessment is conducted every three years to assess performance relative to industry codes, standards, and best practices, and regulatory requirements.
- For Level 1 (awareness training for non-electrically qualified workers) and Level 2 (Qualified Operations Worker training), own electrical safety training programs and develop and deliver these training programs through corporate learning systems with internal electrical safety SME advisement provided by the EESAT.
- Engage the EESAT to advise on defining, developing, deploying, and supporting electrical safety training in compliance with this Standard.
- Maintain records of training, test results, and certifications for students. Ensure that students are notified and engaged to complete training based on the required certification frequencies and worker roles.
- Participate in reviews and internal/external audits of electrical safety training materials, instruction, and records. Revise training programs and content as required.
- As required, seek the advice of the EESAT to resolve specific electrical safety training issues and needs.
- For Level 3 (Task Qualified Worker) and Level 4 (Qualified Electrical Worker LV/HV) Electrical Safety Training, own electrical safety training programs, with training development and delivery support provided by the Technical Training Group and with internal SME advisement provided by the EESAT.
- Assign Safety department members to the EESAT to participate with the EESAT when making contributions to this Standard, in support of various EESAT activities and initiatives, and to provide general safety-related subject matter expertise to the EESAT.

Technical Training Group shall:

- For Level 3 (Task Qualified Worker) and Level 4 (Qualified Electrical Worker LV/HV) Electrical Safety Training, on behalf of Safety Shared Services, steward electrical safety training programs, provide training development and delivery support with internal SME advisement provided by the EESAT.

- Work with the EESAT to define, develop, deploy, and support electrical safety training in compliance with this Standard.
- Maintain records of training, test results, and certifications for students. Ensure that students are notified and engaged to complete training based on the required certification frequencies and worker roles.
- Participate in reviews and internal/external audits of electrical safety training materials, instruction, and records. Revise training programs and content as required.
- As required, work with the EESAT to resolve specific electrical safety training issues and needs.

Field Safety Support shall:

- Assign Safety department members to the EESAT to participate with the EESAT when making contributions to this standard, in support of various EESAT activities and initiatives, and to provide general safety-related subject matter expertise to the EESAT.
- In coordination with Operations, provide direction & oversight in application of electrical safe work practices.
- Assist Operations in the determination of areas and/or equipment that require specific warning signage, specific training for entry, specific PPE requirements, and in implementation of specific Control of Hazardous Energy procedures.
- Assist Operations in determining worker qualification levels, and who has what qualifications, for application of this standard.
- Assist Operations with employee training for the use and care of specific PPE.

## 6.0 ELECTRICAL SAFE WORK REQUIREMENTS

### 6.1 NORMAL AND ABNORMAL ELECTRICAL INSTALLATIONS

The requirements as established within this standard expect that the electrical installations are in a “normal” operating condition (see Definitions for the definition of “normal operating condition”).

Note: “An arc flash incident is not likely to occur during normal operation of equipment that is in a normal equipment condition” (Per CSA Z462/NFPA 70E Definition of Arc Flash). This is also true for shock events.

Where electrical installations do not meet the requirements for a “normal” operating condition, then the equipment is to be considered to be in an “abnormal” operating condition (see Definitions for the definition of “abnormal operating condition”), and additional protective controls will need to be considered and implemented according to the situation. A situation/work task specific hazard

assessment and risk assessment will be required before proceeding with any work in abnormal situations.

Examples of additional controls may include:

- signage and warning labels
- revised operating and maintenance procedures
- increased frequency of, or additional types of, inspections, testing, maintenance, etc.
- restricted access to equipment/rooms/buildings, restricted numbers of switching operations, restrict who is authorized to operate or maintain the equipment, or impose other types of restrictions
- introduce limits to the equipment's operation (e.g., load reductions, reduction in number of equipment operational state changes, voltage reductions)
- use of arc flash and shock PPE for work tasks for which equipment in a "normal" condition does not require – such as routine switching, energy isolation (LOTO), load disconnection/adjustments, etc.
- increasing the required ATPV rating of arc flash PPE beyond the arc flash label incident energy requirements (for example, going to maximum available site ATPV rated PPE due to concerns about uncertain clearing times caused by breaker lubrication issues)
- increase the use of Electrical Safety Watches for tasks which would not need them if the equipment were in a normal condition.
- increase working distance through using hot sticks, remote racking tools, remote operating tools
- apply safety-by-design modifications to reduce incident energy levels (e.g., installing maintenance mode switches or arc flash detection relays)
- if possible, adjust protective device settings to minimize incident energy exposure at the expense of optimum coordination during the time of the energized electrical work task
- remove equipment from service if there are other means of supplying load (such as use a "Side B" unit in lieu of the "Side A" unit if the "Side A" unit's electrical equipment is in an abnormal condition)

Note that abnormally operating equipment or situations, unless permanently removed from service, shall be addressed to return the equipment to a normal state as soon as possible.

## 6.2 ELECTRICAL HAZARDS & CONTROLS

The two primary hazards associated with performing electrical work tasks and non-electrical work within close proximity of energized electrical conductors are electric shock and arc flash (with associated arc blast).

Electric shock is direct contact (or being in close proximity) with exposed energized electrical conductors or circuit parts that causes the flow of electrical current through the human body due to a potential (e.g., voltage) difference (including Step or Touch Potential). The severity of the shock is determined by the amount of current flow, the total time that it flows through the body, and where it flows through the body. A fatality (i.e., electrocution) can generally be the result of current magnitudes of approximately 50 mA or more in a healthy adult human. Burns to the skin and damage to internal organs are also another potential effect of current flow through the body (electrical shock exposure).

Shock Hazards shall be considered at any voltage equal to or greater than 30 VAC or 60 VDC as defined in CSA Z462 or 50 VAC or 50 VDC as defined in NFPA 70E. Shock hazards exist for both AC and DC voltage/current.

Electrical equipment that faults due to an abnormal condition creates an arcing fault and arc flash, which can expose a worker to arc flash incident energy (e.g., heat) causing severe burns to exposed skin. Arc flashes are created when the insulating air gap between exposed energized conductors or circuit parts is compromised, and current flows through the air between two or more conductors, or conductors to ground (i.e., the air is ionized and becomes a conductor).

Some secondary hazards related to an arc flash are:

- Ignition of clothing that is not arc-rated or materials in the proximity of electrical equipment catch on fire;
- Toxic smoke inhalation from vaporized copper;
- Noise that could damage hearing;
- High intensity UV/IR light that may damage eyesight;
- Flying shrapnel and molten metal that may cause injury or damage to health; and
- Extreme equipment damage and resultant down-time for operations.

Figure 1 below provides a graphic representation of an arc flash and the primary hazard of exposure to incident energy (e.g., heat) and the secondary hazards:

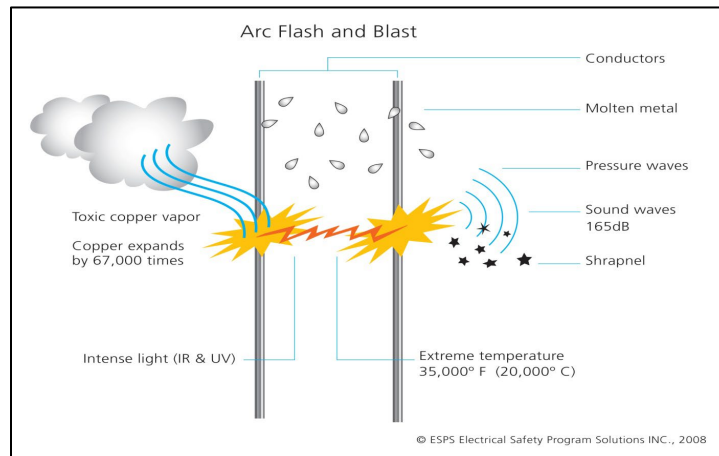

**Figure 1 – Arc Flash Graphic**

An arc flash can be caused by several abnormal conditions on energized electrical equipment including, but not limited to:

- Worker is not competent for the work task;
- Human error during interaction;
- Human behaviour deficiencies;
- Animals entering the equipment;
- Dust and impurities or corrosion on or within the conductors;
- Condensation of water on the surface of insulating material;
- Over-voltages across narrow gaps;
- Insulation breakdown;
- Loose connections;
- Infant mortality, new equipment fails after commissioning;
- Inadequate, incorrect, or inappropriate maintenance of equipment (includes test instruments and specialized testing equipment);
- Poorly designed or incorrect equipment; or
- Improper/inadequate work procedures.

An arc blast is associated with the release of pressures due to an arcing fault. Dangers associated with an arc blast event are high air pressures, high noise levels and flying shrapnel. High pressures can push workers back from the equipment they are working on, knocking workers off ladders, breaking bones, rupturing eardrums, and collapsing lungs. High noise levels can cause hearing loss and flying shrapnel can penetrate the human body.

Though recoverable traumatic type injuries have occurred as a result of arc blast, there is no history of arc blasts directly causing the death of a worker.

There are very few methods for mitigating the effects of arc blast aside from remote operation or increases to working distances, and/or methods for reducing the likelihood of an arc flash incident occurring in the first place.

Workers are encouraged to also consider the effect of arc blast when planning work activities – for example, if possible, try to avoid working on a ladder or elevated surface which, in case an arc flash and blast occurred, could lead to a fall. Also, pay attention to the edges of corners of equipment or other structures which the worker's body could be pushed into as a result of arc blast pressure.

Enbridge will consider other options for mitigating arc blast effects if they become available.

Preventative and protective control methods should be considered on a priority basis as per the hierarchy of risk control methods as listed below to mitigate or reduce exposure to electrical hazards:

1. Elimination – Physically remove the hazard by de-energizing, isolating and locking out electrical energy sources to establish an 'Electrically Safe Work Condition'
2. Substitution – Replace the hazard through use of safer systems, processes or materials
3. Engineering Controls – Isolate workers from the hazard through 'Safety by Design', and Equipment 'Safety by Design' including effective electrical equipment maintenance. Examples of Safety by Design approaches include maintenance mode switches, arc flash detection relays, remote racking and remote operating panels, permanently installed absence of voltage indicators, etc.
4. Administrative Controls – Change the way people work through training, procedures, warning/danger signs and barricading
5. PPE – Protect the worker with electric specific PPE, tools, and equipment through proper selection/specification, pre-use checks, usage, storage, inspection, certification/testing, and ongoing maintenance.

### 6.3 WORKER QUALIFICATIONS AND ELECTRICAL WORK TASKS

All workers completing electrical work tasks shall be qualified for the tasks they perform and, as a minimum, follow the requirements of this standard, CSA Z462 in Canada or NFPA 70E in the USA and all other applicable electrical standards, (such as the electrical safety regulations in the Code of Federal Regulations and the National Electrical Safety Code/IEEE C2 for the US, or CAN/ULC S801-10 "Standard for Electric Utility Workplace Electrical Safety for Generation, Transmission and Distribution for Canada), codes and regulations. They shall be trained in electrical specific PPE, safety-related work practices and procedural requirements as necessary to provide protection from the electrical hazards associated with their respective job or work task assignments. They shall also receive technical training for the specific electrical equipment they

work on. This technical training shall include training on new electrical equipment/facilities/systems, refresher training, and initial training for new workers or role changes.

The types of electrical work tasks workers are authorized to perform will depend on their level of qualification. Enbridge has established seven categories of electrical qualification as follows based on a worker's level of electrical knowledge and skills:

- **Qualified Electrical Worker (QEW)** – Qualified Electricians (US), Journeymen Electricians unless otherwise approved and deemed qualified (CAN), Electrical Engineers/Technologists, Power Generation and Power Line Technicians
- **Associate Electrical Worker (AEW)** – Apprentice Electricians, Qualified Electrical Workers-in-Training
- **Task Qualified Worker (TQW)** – HVAC, Fire, Overhead Door, Crane, & Cathodic Protection system Technicians, Security Technicians, Vendor or Factory Service Technicians, Wind Turbine Technicians, Solar Power Technicians, and many others.
- **Qualified Instrumentation Worker (QIW)** – Instrumentation Technicians
- **Qualified Operations Worker (QOW)** – Mechanical Technicians, Pipeline Maintenance (PLM) Technicians, Operations Technicians, Field Operators
- **Non-Electrical Worker (NEW)** – All other workers that do not meet the criteria of a QEW, AEW, TQW, QIW, or QOW.
- **Electrical Safety Watch (ESW)** – Preferred QEW serving in the role as an ESW, or may be another worker category under emergency conditions, off-hours, or at remote locations.

See 'Appendix A' for a table indicating the types of electrical work tasks workers are authorized to perform based on their level of electrical qualification.

## 6.4 ELECTRICAL SAFE WORK REQUIREMENTS

All employees and contractors are expected to follow the electrical safe work requirements as established in CSA Z462 and NFPA 70E. These include:

- Establishing an electrically safe work condition by de-energizing, locking out, and testing electrical equipment before working on it.
- Completing a Risk Assessment for an assigned energized electrical work task.
- Conducting an equipment-specific Arc Flash Risk Assessment and Shock Risk Assessment for a justified energized electrical work task.
- Applying the Arc Flash Boundary and Shock Approach Boundary to the work task.



- Establishing an Electrical Work Zone and providing a suitable barrier to restrict access at the Arc Flash Boundary or Limited Approach Boundary for Shock whichever is further away.
- Ensuring electric specific PPE, tools and equipment that meets CSA, UL, ASTM, ANSI and other applicable Standards is specified, stored, used, and maintained; and that the correct PPE is selected and used as appropriate to the hazard.
- Reporting all electrical events including near misses.
- Implementing an appropriate Emergency Response Plan for electrical events.
- Implementing Management of Change (MOC) processes as required for changes to energized electrical power distribution equipment and electrical safe work practices and procedures.

Additionally, during verification activities, if an isolation point is found to be tagged or labeled incorrectly or the tag/label is missing, any work taking place shall be stopped until the tag or label is corrected or replaced. For LP: refer to section '6.6 – Lockout/Tagout Assurance Process for Asset Management' in the Control of Hazardous Energy Safety Standard.

#### **6.4.1 ESTABLISHING AN ELECTRICALLY SAFE WORK CONDITION**

All electrical equipment shall be de-energized and placed in an electrically safe work condition by a qualified electrical worker prior to commencement of work on it unless the work is otherwise justified and/or approved to be completed in an energized state as per the requirements of this standard. All electrical equipment shall be considered energized until it is proven de-energized (e.g., tested for absence of voltage – “TEST-BEFORE-TOUCH”).

To establish an electrically safe work condition, the following process is to be followed:

1. Determine all possible sources of electrical supply to the specific equipment. Check applicable up-to-date Single Line Diagrams and identification tags against what exists in the field.
2. Properly interrupt the load current and open (i.e., turn off) the disconnecting device(s) for each source.

**Note:** The following are **not** considered as a means of disconnection:

- Shutting off a control interlock or other device
- Using three or four-way switches
- Switching off the control switch of a motor

Switching and Isolation Orders for high voltage power distribution systems shall be approved by the QEWHV.

3. Where possible, visually verify that all blades of the disconnecting devices are fully open, or draw-out type circuit breakers are withdrawn to the fully disconnected position.
4. Release stored electrical energy.
5. Release or block stored mechanical energy.
6. Apply lockout/tagout devices in accordance with the Control of Hazardous Energy Standard (LP) or SOP 5-3070 Hazardous Energy Control (Lockout/Tagout) (GTM)
7. Use an adequately rated test instrument (e.g., voltage detector) to test each phase conductor or circuit part at each point of work to verify they are de-energized. Before and after each test, determine that the test instrument is operating correctly – i.e., TEST-BEFORE-TOUCH
  - On electrical equipment greater than 1000 VAC/1060 VDC in Canada or greater than 1000 VAC or VDC in the USA, the use of a non-contact test instrument is approved for use.
8. Where the possibility of induced voltages or stored electrical energy exists, ground the phase conductors or circuit parts before touching them. Where it could be reasonably anticipated that the conductors or circuit parts being de-energized could contact other exposed energized conductors or circuit parts, apply temporary protective ground connecting devices (e.g., follow an approved procedure for the use and application of temporary protective grounds or Ground Truck Test Devices) rated for the available fault duty. Post a sign indicating the presence of temporary protective grounding in a readily visible location (e.g., on outside of cabinets/enclosures) on the equipment being grounded. See ‘**Appendix B**’ for an image of the sign.

Complete an Electrical Switching & Work Clearance Form only when providing grounds on high voltage and upstream of 480V or 600V main breakers. See ‘**Appendix C**’ for a sample of the form.

**Note:** *In some situations it may not be possible to install temporary protective grounding due to bus configurations, space limitations, lack of a suitable connection point, equipment access restrictions, etc. In these situations, the workers are to note on the Electrical Switching and Work Clearance Form that temporary protective grounding could not be applied to the equipment. Workers are still required to use the temporary protective ground set, or a properly certified “flash stick”, to perform “flash” checks to confirm absence of voltage if potentially energized electrical conductors or circuit parts are accessible. Workers are to ensure that temporary protective ground sets, flash sticks, or other devices used to “flash” the components or busses are fully rated for the short circuit capability of the installation. Also, some conductors may recharge or have inductively induced voltages which change over time, so additional or periodic flash checks may be required.*

## 6.4.2 ENERGIZED ELECTRICAL WORK

Energized electrical work is defined by Enbridge as:

- Intentionally entering and performing a work task inside the Restricted Approach Boundary for Shock.
- Interacting with electrical equipment in which conductors or circuit parts are not exposed, but an increased likelihood of injury from an exposure to an arc flash hazard exists.

**Note:** *Operating switches or breakers is not considered to be energized electrical work (even though portions of the internal electrical equipment may be energized) unless at least one of the two previously listed activities is being performed.*

Some examples of work tasks that are considered energized electrical work are:

- Voltage measurement.
- Current measurement.
- Local insertion or removal (racking in or out) power circuit breakers.
- Disconnecting and reconnecting batteries.
- 'Justified' repair and alteration of conductors and circuit parts in an energized state.

A Risk Assessment is required to be completed for all energized electrical work tasks performed by qualified electrical workers (QEWs). The purpose of the assessment is to evaluate the overall risk level of the energized electrical work task and to identify controls required to mitigate the risk to an acceptable level. Risks associated with many energized electrical work tasks typically performed by QEWs at Enbridge have been pre-assessed and are documented in an Electrical Work Task Risk Register (see Fig. 2 below). This Risk Register is required to be made readily available to all Enbridge QEWs performing energized electrical tasks and shall be used by those performing the work in determining the level of risk control necessary to mitigate the risks under the identified operating conditions. The Risk Assessment identifies the documentation required to be completed, requirements for other administrative controls and need for electrical specific tools and PPE. A snapshot of a portion of the risk register is provided in Figure 2 below; and a summary of the risk assessment results for each of the tasks assessed as identified within the Risk Register, can be found in '**Appendix D**'. The LP Governance Document Library (GDL) has the latest complete version of the Risk Register, along with instructions for use, an indexing system for convenient reference, supporting assumptions, task specific heat mapping, and other important information.

The Electrical Work Task Risk Register from the LP GDL and/or the work task summary table in Appendix D shall be consulted for the intended work task, and if an applicable work task cannot be found, then a work task specific risk assessment shall be performed in accordance with Enbridge's Risk Assessment process and documented prior to proceeding with the work. The need to add

such tasks to the Electrical Work Task Register will be reviewed by the Enbridge Electrical Safety Advisory Team.

The Electrical Work Task Risk Register is developed assuming that electrical equipment is in a “normal” operating condition. If equipment is in an “abnormal” operating condition, then the requirements in the Electrical Work Task Risk Register for a given work task may not be valid or may be incomplete in some cases. If the equipment cannot be returned to a normal operating condition prior to the work task being performed, then a work task specific risk assessment shall be performed for the equipment in an abnormal condition in accordance with Enbridge’s Risk Assessment process and documented prior to proceeding with the work. See also section 6.1 above for additional information pertaining to equipment in an abnormal condition.

Note: For projects, work tasks executed during construction and commissioning will compile and retain energized electrical work documentation in accordance with the project’s document retention policy.

Note: For projects, contractors and commissioning workers planning to execute Electrical Work tasks on greenfield project sites shall apply Lockout / Tagout (LOTO) procedures in accordance with the appropriate regulatory requirements and company policies. In the event a task is required to be completed in an energized state due to infeasibility, the project team shall follow the energized electrical work permit process described below. The Operations Technical Supervisor signature may not be required for greenfield sites.

Reviewed	Work Task Description	Equipment Condition Assumptions (Refer to the Assumptions & Notes tab for additional assumptions!)	Energized Electrical Work (Per ESS Definition)	Arc Flash or Shock Hazard Present?	Arc Flash PPE required (as per NFPA & CSA Standards) or Shock PPE Tools & Equipment	Energized Electrical Work Permit (EEWP) Required	Can Qualified Operations Worker (QOW) perform task?	Electrical Safety Watch	Notes
1A	Reading a panel meter while operating a meter switch (includes digital meters)	Normal	No	No	Minimum Enbridge Std PPE ESP Level 0	No	Yes	No	No incident because no interaction
				No	Minimum Enbridge Std PPE ESP Level 0				No incident because no interaction
1B	FIRST TIME ONLY AFTER SERVICING: Local or remote operation of a circuit breaker (CB), switch, contactor or starter after installation, completion of work, commissioning, or maintenance in the equipment. See Comments.	Normal	No	Arc Flash	Arc Flash PPE as determined by incident energy level.	No	No	No	The “First time only after servicing” task is added due to NFPA 70E and CSA 2462 updates, and requires wearing properly rated arc flash PPE when energizing equipment even for equipment in a normal operating condition. It reflects a slightly higher risk of equipment failure after
				No	Minimum Enbridge Std PPE ESP Level 0				ESS definition of energized work does not include switching or operation of electrical equipment in a normal operating condition since doors are closed and there is no crossing of the restricted approach.
1C	Local or remote operation of a low voltage circuit breaker (CB), switch, contactor or starter	Normal	No	No	Minimum Enbridge Std PPE ESP Level 0	No	Yes	No	ESS definition of energized work does not include switching or operation of electrical equipment in a normal operating condition since doors are closed and there is no crossing of the restricted approach.
				No	Minimum Enbridge Std PPE ESP Level 0				
1D	Local operation of high voltage power circuit breaker (CB) in arc resistant switchgear	Normal	No	No	Minimum Enbridge Std PPE ESP Level 0	No	CAN - No US - Yes	No	All doors closed and all covers in place and fully bolted/fastened (as applicable to the specific equipment). No personnel within 10' of any arc flash plenum exhaust openings. Not permitted in Canada for QOWs due to trade regulations.
				No	Minimum Enbridge Std PPE ESP Level 0				

Figure 2 – Electrical Work Tasks Risk Register (partial sample image)

### 6.4.3 ENERGIZED ELECTRICAL WORK PERMIT

Further to the requirement for a risk assessment, an Energized Electrical Work Permit (EEWP) and associated flowchart (see ‘Appendix E’ for a sample of the EEWP form and see ‘Appendix F’ for the associated flowchart) is required when crossing the Restricted Approach Boundary; or when

an individual interacts with equipment where conductors or circuit parts are not exposed, but an increased likelihood of injury or damage to health from an exposure to an arc flash or shock exists, including closed equipment. There are exceptions to the need for this permit for specific energized electrical work tasks as outlined further within this section.

Where an EEWP is required for Operations work or Operations directed contractors: Section 1 is to be completed by the Qualified Electrical Worker responsible for the work with input from all other affected worker(s) involved. Section 2 should be completed by the Qualified Electrical Worker performing the work. It shall be completed during pre-job planning phase of the work and must be approved in Section 3 by the workers' People Leader prior to work commencing. Refer to the EEWP form and guidance information.

Where an EEWP is required for Project construction work, Section 1 is to be completed by the Enbridge Construction Manager responsible for the work with input from all other affected worker(s) involved. Section 2 should be completed by the Contractor Qualified Electrical Worker performing the work. Section 3 will need to be approved by Operations Electrical Supervisor (not applicable for greenfield work) and the Project Manager prior to work commencing.

Where an EEWP is required for Commissioning tasks, Section 1 should be completed by the Commissioning Coordinator responsible for the work with input from all other affected worker(s) involved. Section 2 should be completed by the Commissioning Qualified Electrical Worker performing the work. Section 3 will need to be approved by the Operations Electrical Supervisor (not applicable for greenfield work) and the Project Manager prior to work commencing.

The information identified on the EEWP and referenced documents (e.g., JHAs, FLHAs, Procedures etc.) shall be reviewed at the pre-job meeting held prior to the commencement of work. All workers involved in the work must be present and actively participate in the pre-job meeting. Additional meetings may be required to acquire the necessary signatures for approving the EEWP. When all workers have completed the pre-job meeting for approved energized work, a Safe Work Permit will be documented on the EEWP including start/end times for approved energized electrical work.

The purpose of the EEWP is to verify that:

- there is justification for why the work must be performed on equipment in an energized state
- all hazards including electrical hazards are considered within the Job Hazard Assessment and Field Level Hazard Assessment for the work,
- electrical safe work and technical procedures required for the work are identified and will be utilized,
- arc flash and shock risks have been assessed for the equipment being worked on,
- electrical specific PPE, tools and equipment required for the work are identified and will be utilized.

Work can only be justified to be performed in an energized condition when either of the two following conditions can be satisfied:

- it can be demonstrated that de-energizing introduces additional or increased hazards or risk,
- the task to be performed is determined to be infeasible in a de-energized state because of equipment design or operational limitations (examples include testing for absence of voltage; or some troubleshooting, maintenance, calibration, diagnostic, or measurement tasks needing to be performed while energized).

Energized Electrical Work Permits are not required for the following energized electrical work performed by a Qualified Electrical Worker (or other applicable worker categories such as Task Qualified Workers working within their authorized scope) using approved safe work practices/procedures and appropriate electrical specific PPE, tools and equipment:

1. Working on electrical conductors or circuit parts that operate at less than 30 VAC or 60 VDC in Canada, and 50 VAC or VDC in the USA (voltages are to-ground, phase-to-phase, or pole-to-pole as applicable to the circuit configuration).
2. Testing, troubleshooting, and voltage and current measurements.
3. Thermography, acoustical or visual inspections if the Restricted Approach Boundary for shock is not crossed (e.g., for 208 VAC/480 VAC/600 VAC electrical equipment this distance is 12" or 305 mm).
4. Access and egress to an area with exposed energized electrical equipment if no electrical work is performed and the Restricted Approach Boundary for shock is not crossed.
5. General housekeeping and miscellaneous non-electrical work tasks if the Restricted Approach Boundary for shock is not crossed.
6. Racking in or out low or high voltage power circuit breakers due to infeasibility.
7. Installing temporary protective grounds due to infeasibility.
8. Remove bolt on covers for voltage measurement due to infeasibility.
9. Open hinged doors on energized electrical equipment due to infeasibility.
10. Operating energized electrical equipment due to infeasibility
11. Removing or installing conductors and circuit parts less than or equal to 125 VDC/AC such as relays, control equipment, analyzers, or Programmable Logic Controller (PLC) components in electrical equipment due to infeasibility.

#### **6.4.4 ARC FLASH AND SHOCK HAZARD RISK ASSESSMENT**

Enbridge conducts engineering incident energy analyses to assess the arc flash and shock hazards associated with energized electrical conductors or circuit parts. The results of these analyses are included on detailed arc flash and shock warning labels (see Fig. 3 and Fig. 4 below) applied to the applicable installed electrical equipment. These labels are used to identify the:

- Incident Energy exposure on the worker’s body (i.e., head and torso) at the working distance
- The Arc Flash Boundary distance
- Maximum voltage, Limited Approach Boundary and Restricted Approach Boundary
- Class of Rubber Insulating Gloves to be worn.

This information is further used for the selection of appropriate electrical specific PPE, tools & equipment required to protect personnel from such hazards and reduce risk.

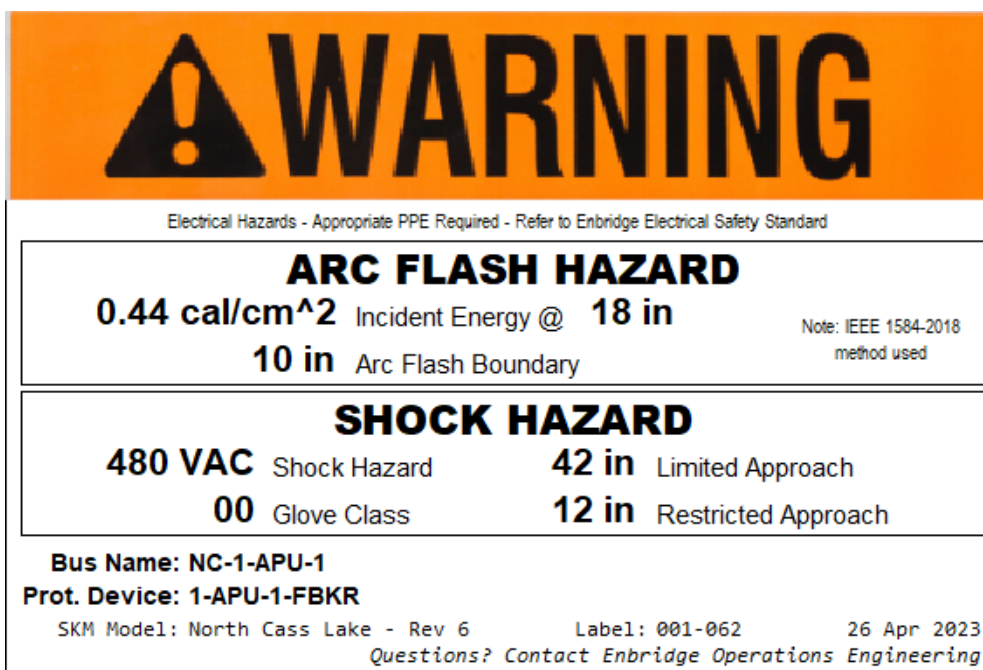

**Figure 3 – (LP Only) Sample Detailed Arc Flash and Shock Warning Label**





# WARNING

## Arc Flash and Shock Hazard Present

PPE Required Label No. 123

ARC FLASH PROTECTION		SHOCK PROTECTION	
Working Distance	<b>18 in</b>	Voltage	<b>480 VAC</b>
Incident Energy	<b>6.5 cal/cm<sup>2</sup></b>	Limited Approach	<b>3 ft 6 in</b>
Arc Flash Boundary	<b>2 ft 4 in</b>	Restricted Approach	<b>1 ft 0 in</b>
		Glove Class	<b>00</b>

*Refer to Enbridge Electrical Safety Standard for PPE Requirements*

---

<b>Equipment PNL-EXAMPLE</b> <b>Optional note here, e.g. maintenance mode</b> <i>Changes in equipment settings or system configuration will invalidate the calculated values and PPE requirements</i>	Date: <b>08-08-2021</b> Method: IEEE 1584-2018 ENB Report ID: AF0001 Analysis by: ABC Engineering
---	--

**Figure 4 – (GTM Only) Sample Detailed Arc Flash and Shock Warning Label**

When an energized electrical work task is justified, the arc flash and shock hazard information identified on the label of the equipment being worked on must be documented on the Energized Electrical Work Permit completed for the work. If an Energized Electrical Work Permit is not required, this information should be documented with the Job Hazard Assessment (JHA) or Field Level Hazard Assessment (FLHA) completed for the work.

The worker shall select arc flash PPE rated for the incident energy exposure for the equipment being worked on (i.e., the Arc Thermal Performance Value (ATPV) of the PPE ensemble will equal or exceed the applicable arc flash and shock warning label's indicated incident energy).

When the incident energy exposure exceeds the ATPV of the available PPE, then additional measures are required:

1. Restrict work tasks to de-energizing the involved equipment (if possible, at an upstream location) to only establishing an electrically safe work condition.
2. When testing for absence of voltage (as part of establishing an electrically safe work condition), the following measures can be considered to reduce the likelihood of an arc flash occurring and/or to reduce the incident energy exposure to the workers:
  - a. Use non-contact proximity test instrument(s) or measure voltage on the low voltage secondary side of a transformer located in the equipment BEFORE use of a contact test instrument to test for absence of voltage for equipment operating at 1000 V or less. If possible, also use additional means for checking and assuring that the equipment is de-energized such as checking that the fed electrical equipment is de-



- energized, check on/off statuses on other affected electrical equipment, check voltage readings on equipment mounted volt meters or power meters, check on/off or open/close statuses on breakers or switches supplying the equipment being worked on, etc. All additional means need to also indicate that the equipment is de-energized,
- b. Ensure visually (where possible) that all isolation gaps between equipment conductors and circuit parts are physically open/separated (for example look for open switch blades or contacts on disconnect switches),
  - c. Increase the working distance as much as practical through remote operating equipment, hot sticks, or other means,
  - d. Temporarily adjust protection relays to minimize clearing time (under proper change management processes) and/or use maintenance mode switches if available.
3. Consider system design options to reduce the incident energy level (possibly reducing the incident energy exposure for future work tasks), such as maintenance mode switches, arc flash relays, etc.

**Note:** *workers are encouraged to use maintenance mode switches if this provision is present in the electrical equipment. Consult with engineering if additional guidance is needed. Arc flash and shock warning labels will indicate reduced incident energy exposure levels if maintenance mode switches are activated.*

Workers shall consult their People Leader if equipment is not clearly labeled with an arc flash and shock warning label, the Incident Energy Level of a given task is unclear or unknown, or other factors are unknown.

In such cases, if necessary, the shock and arc flash risk assessment can be done using alternative methods (always consult with your engineering support):

For shock hazard, the voltage of the system is required to determine the electrical specific PPE, tools and equipment required and the shock protection boundaries. Refer to the shock protection boundary tables in CSA Z462 Clause 4.3.4.4 Tables 1A & 1B (CAN) and NFPA 70E 130.4(D) Tables 130.4(D)(a & b) (US) to determine the limited and restricted approach boundaries for shock.

For arc flash hazard, the Arc Flash PPE Category Method as specified in CSA Z462 Clause 4.3.7.3.15 Tables 6A & 6B (CAN) and NFPA 70E 130.7 I(15) Tables 130.7 I(15)(a & b) (USA) may be used for the selection of arc flash PPE and determination of the arc flash boundary, if the specified parameters are met (if not, consult with engineering support for guidance).

For DC Systems:

For LP: refer to Appendix K – Electrical Hazard for DC Systems and Remote Valve Sites.

---

For GTM: refer to *Arc Flash Incident Energy Analysis DS-AFH* Appendix C for DC battery banks and systems of various sizes.

#### **6.4.5 ARC FLASH & SHOCK APPROACH BOUNDARIES**

Qualified Electrical Workers (QEW's) who cannot establish an Electrically Safe Work Condition and are required to work within the Arc Flash Boundary or Restricted Approach Boundary shall:

- be appropriately qualified for the work task,
- conduct a Job Hazard Assessment (JHA) and, if available, use approved work procedures/job plans,
- wear appropriate arc flash and shock PPE for the work task,
- utilize insulated hand tools and equipment with ratings that exceed the maximum voltage exposure,
- utilize a QEW as a safety watch where required, and
- complete an Energized Electrical Work Permit and FLHA as required.

Non-electrical workers (NEW's) shall not be permitted to approach within the Arc Flash Boundary or Limited Approach Boundary unless wearing appropriate PPE, a QEW advises them of the possible hazards, and a QEW continuously escorts them while inside the boundary. Non-electrical workers are not permitted within the Restricted Approach Boundary at any time.

#### **6.4.6 ELECTRICAL EQUIPMENT AREAS, ELECTRICAL WORK ZONES, AND ACCESS RESTRICTIONS FOR ELECTRICAL BUILDINGS AND AREAS**

Electrical Equipment Areas (EEA's) are used to permanently establish safe spaces around electrical equipment.

Electrical Work Zones (EWZ's) are used to temporarily establish safe spaces around the work areas when performing energized electrical work tasks on electrical equipment.

Access restrictions for electrical buildings and areas are to be introduced to restrict access to only authorized personnel who have a business reason to be in these areas.

##### **Electrical Equipment Areas (EEAs)**

*Electrical Equipment Areas (EEAs):* are permanently demarcated areas around the electrical equipment that allow for ongoing safe electrical equipment operation, maintenance, and other work tasks. They are intended to keep the area around the electrical equipment free from combustible items, tripping hazards, and other obstructions, allow for the safe performance of electrical work tasks, and will reduce the amount of collateral damage which can occur as a result of an electrical fire or arc flash incident. They also allow the non-electrical equipment, materials, and various work activities to be performed safely without getting too close to the electrical equipment.

An EEA can be established in existing situations where fixed electrical power equipment (such as motor control centres, VFD equipment, disconnect switches, lighting power transformers, UPS/battery charger systems, larger electrical cabinets/enclosures, etc.) are located in proximity to general storage areas, warehouse areas, workshops, maintenance areas, office areas, vehicle garages, traffic areas and walkways, areas where equipment or facilities exist which frequently need operational attendance, etc. In these situations, measures need to be taken so that the electrical equipment and associated work tasks in and around that equipment have sufficient space do be done safely; and similarly, that the non-electrical equipment, materials, work tasks, etc. also have sufficient space do be done safely.

Note: light switches, receptacles, smoke detectors, or other small permanently installed end devices would not normally be a trigger for establishing an EEA.

Note: the EEA is not intended to accommodate non-electrical work areas (such as office areas) or storage areas (such as materials storage) in electrical buildings and rooms (whose primary purpose is to accommodate electrical equipment). The EEA is intended to be a “measure of last resort” for existing installations, congested areas which cannot be easily decongested, and other problematic situations that may arise in the field.

Non-essential equipment, materials, obstructions, or other items; and unauthorized personnel or work activities, are not permitted in the EEA.

To establish the boundary of the EEA, a fixed distance is not provided, but various factors should be considered in defining the EEA boundary such as:

- the minimum electrical code distances,
- the need to establish an Electrical Work Zone (EWZ) when energized electrical work is being performed (the EWZ is set to the greatest distance of the arc flash boundaries, limited approach boundaries, and a minimum EWZ radial distance of 10’),
- the presence of existing physical barriers such as walls, doors, fences, partitions, or other existing barriers,
- access and egress requirements for work tasks and emergency situations.

**Note:** *it is always a best practice to incorporate layout and facility usage considerations into facility/building layout design at the outset of a project. That will allow us to minimize any potential conflicts between electrical equipment, worker needs and the needs of the other work activities and work areas.*

Spacing considerations when planning electrical work tasks (and other tasks) in and around electrical equipment can include:

- If there are conflicts in space or access/egress requirements, consult with Operations personnel and people leaders to remove conflicting items and establishing an electrical equipment area. Also make sure that your access/egress planning accommodates the presence of open electrical equipment enclosure doors, racked out breakers or other equipment temporarily located outside of its enclosures, or other obstructions which may interfere with proper access/egress.

- Wherever possible, try to establish two means of access/egress to any area where you will be doing energized electrical work tasks. Consider both energized electrical work task needs, plus what might be needed if you have an emergency situation and may need to treat, assist and rescue a downed worker (i.e., as part of electrical emergency response planning (see Section 6.14)).

### Electrical Work Zone (EWZ)

EWZs are used to temporarily establish safe spaces around work areas when performing energized electrical work tasks on electrical equipment.

The EWZ shall be established and managed by the QEW while there is exposed energized equipment. The purpose of the EWZ is to ensure that the QEW's can safely perform their energized electrical work tasks without distraction, and it is also intended to keep unauthorized personnel (who may interfere with the work or distract the electrical workers while performing the task) out of the work area. The EWZ shall be established at the Limited Approach Boundary or the Arc Flash Boundary whichever is further away, and shall be at least 3 m (10 ft.) to ensure adequate work space is provided. In some cases, existing doors and walls can also be used to define the EWZ.

In different situations, different methods can be used to manage the EWZ perimeter:

1. In high traffic or congestion areas, physical perimeters can be established and/or Safety Watches can enforce the perimeter access.
2. In minimal traffic situations, the QEW's can verbally instruct personnel on the need to stay outside of the EWZ.

If physical perimeters or barriers of the EWZ need to be established, and the EWZ is actively being managed by the QEW's, then the physical perimeter can be defined using temporary plastic tape, plastic stanchions with retractable tape, magnetic or permanently mounted retractable tape, other appropriate barricades or fencing.

If a Safety Watch is used, that Safety Watch shall know where the EWZ is, remain outside of it, and instruct approaching personnel on the need to stay outside of the EWZ.

For situations where an EWZ is to be left unattended for a period of time the following steps need to be considered:

1. If possible, close the enclosure doors and covers and then the EWZ is no longer needed.
2. If the enclosure doors are still required to stay open, then the EWZ is still required, and the EWZ shall be delineated using red DANGER flagging tape, with properly completed flagging tags. The electrical equipment may also need to be temporarily protected from the weather or other environmental hazards. Communicate this situation and restrictions to affected site personnel. For locations with unrestricted or public access, then additional safeguards or warning signage or security may be needed – consult with your People Leader.

An EWZ shall be established for energized electrical work tasks using a suitable barrier to prevent unauthorized access to all entry points to the zone. The EWZ shall be established at the Limited Approach Boundary or the Arc Flash Boundary whichever is further away, but shall be at least 3 m (10 ft.) to ensure adequate work space is provided. The perimeter of the EWZ shall be managed. It can be managed either by establishing physical barriers or by other means:

Physical barriers can include temporary plastic tape (e.g., red 'Danger' tape, plastic stanchions with retractable tape, magnetic or permanently mounted retractable tape, other appropriate barricades or fencing). Note: Temporary physical barriers are not required where unauthorized access to the EWZ is prevented by building walls and doors.

Other means can include: In locations where the only personnel present, or expected to be present, are the QEW's doing the work, then no specific measures are needed to physically establish/demarcate the EWZ.

The EWZ can only be crossed by authorized QEWs. Other workers, not qualified and authorized, shall not cross the EWZ boundary unless approved by the authorized and QEW and shall be continuously accompanied by the QEW when inside the EWZ. When other workers are inside the EWZ they shall be wearing the appropriate PPE as directed by the QEW. Unqualified workers shall not cross the Restricted Approach Boundary for Shock at any time.

All energized electrical work must be completed, and the permit closed, prior to removing any barriers and/or the Qualified Electrical Safety Watch. A safe electrical work zone must be maintained for the duration of all energized electrical work tasks.

EWZ for High Voltage Substations, Transmission Lines, and Distribution Lines:

Where the use of barriers to establish an EWZ is not deemed to be practical, such as within some areas in high voltage substations, near transmission and distribution overhead lines, etc., a Qualified Electrical Worker with high voltage training (QEWHV) must be used as an Electrical Safety Watch. Electrical Safety Watches control access to the EWZ. In some cases, multiple QEWHV Safety Watches may be required.

Non-qualified personnel may be used to control access to a high voltage substation if they are located at the perimeter fencing/gates (they must remain outside of the substation fencing or gates unless escorted in by a QEWHV).

### Access Restrictions to Electrical Buildings and Areas

Only authorized personnel, with an appropriate business reason, shall be permitted in electrical buildings, electrical rooms, Electrical Equipment Areas, and Electrical Work Zones.

Appropriate signage, communications, and policies shall be developed and implemented to control access to these facilities and areas.

## 6.5 ELECTRICAL-SPECIFIC PPE, TOOLS AND EQUIPMENT

Workers performing tasks in areas where there are potential electrical hazards shall be provided with, and shall use, PPE, safety tools, and equipment that are appropriate for the task.

Workers shall be trained on proper selection, care, use, maintenance, storage, inspection, and certification of electrical specific PPE, tools, and equipment.

All electrical specific PPE, tools & equipment shall be of a safe design and construction for the task for which they are to be used. They must meet and/or be certified to all applicable Standards including CSA, UL, ULC, ANSI, IEEE or ASTM. When required they must be suitably marked indicating approval ratings and test dates as applicable.

Electric specific PPE, tools and equipment must be inspected for visual defects prior to use to ensure it is inscribed with appropriate certification marks, fit for use and that it has a sticker or tagging that indicates it has been tested, where applicable.

If there is any doubt as to the safety or integrity of electric specific PPE, tools, and equipment, it must be discarded and replaced with new and/or tested equipment.

### ***6.5.1 ELECTRICAL PERSONAL PROTECTIVE EQUIPMENT***

As a minimum, the three level PPE system as indicated in Figure 5 has been adopted by Enbridge for broad usage across the organization. The poster below is to be issued to sites and posted in and around electrical rooms, buildings, electrical work areas, lunchrooms, and shop areas for ease of reference.

It is noted that certain Business Units, regions within Business Units, or contractors may also have PPE systems that differ from this system. The minimum expectation is that all workers will select appropriate arc flash and shock PPE for the specific work task and exposure, in alignment with this standard and CSA Z462/NFPA 70E and the other applicable industry standards (see Appendix I for additional information).

If you have existing PPE and/or PPE standards which conflict with this standard, consult with your People Leader and/or the EESAT to resolve any conflicts.



<h2 style="margin: 0;">ARC FLASH PPE GUIDE</h2> <p style="margin: 0; font-size: small;">Selection of Arc-Rated Clothing and Other PPE for Use When Incident Energy Exposure Is Determined by Label For more detailed information or other options refer to NFPA 70E Table 130.5(G) or CSA Z462 Table 3</p>		
FR/Arc-rated PPE for electrical workers shall meet the minimum Arc Thermal Performance Value (ATPV) of 8 cal/cm <sup>2</sup> and increase as required by incident energy exposure. Workers shall wear undergarments made with a natural fiber (e.g., cotton, wool, or silk).		
<p style="text-align: center;"><b>LEVEL 0</b></p> <p style="text-align: center;">Incident Energy Exposure <b>&lt;1.2 cal/cm<sup>2</sup></b></p>	<ul style="list-style-type: none"> <li>FR/Arc-rated Long Sleeve Shirt and Pants or FR/Arc-rated Coveralls (FR/Arc-rated Jacket, Parka or Rainwear as req'd for Weather)</li> <li>Hard Hat</li> <li>Safety Glasses</li> <li>Heavy Duty Leather Work Gloves</li> <li>Leather Ohm Rated or EH Rated Footwear</li> </ul>	
<p style="text-align: center;"><b>LEVEL 1</b></p> <p style="text-align: center;">Incident Energy Exposure <b>≥1.2 cal/cm<sup>2</sup> – 12 cal/cm<sup>2</sup></b></p> <p style="text-align: center; font-size: x-small;">Arc-rated clothing and equipment with an ATPV rating equal to or greater than the determined incident energy.</p>	<ul style="list-style-type: none"> <li>FR/Arc-rated Long Sleeve Shirt and Pants or FR/Arc-rated Coveralls (FR/Arc-rated Jacket, Parka or Rainwear as req'd for additional ATPV or Weather)</li> <li>Class E Hard Hat</li> <li>Hearing Protection</li> <li>Safety Glasses</li> <li>Arc-rated Face Shield and Arc-rated Balaclava</li> <li>Rubber Insulating Gloves with Protectors</li> <li>Leather Ohm Rated or EH Rated Footwear</li> </ul>	
<p style="text-align: center;"><b>LEVEL 2</b></p> <p style="text-align: center;">Incident Energy Exposure <b>&gt;12 cal/cm<sup>2</sup></b></p> <p style="text-align: center; font-size: x-small;">Arc-rated clothing and equipment with an ATPV rating equal to or greater than the determined incident energy.</p>	<ul style="list-style-type: none"> <li>Arc Flash Suit: Arc-rated Arc Flash Suit Hood with Head Protection, Arc-rated Jacket, and Arc-rated Pants or Coverall (Bib Overall Recommended)</li> <li>Safety Glasses</li> <li>Hearing Protection</li> <li>Rubber Insulating Gloves with Protectors</li> <li>Leather Ohm Rated or EH Rated Footwear</li> </ul>	

Figure 5 – Three Level PPE System



1. Flammable synthetic materials may not be worn under Arc Rated (AR) clothing as they can melt to the skin in an arc flash incident. Excluding AR garments, this includes acetate, acrylic, nylon, polyester, polyethylene, polypropylene and spandex, either alone or in blends.
2. Rubber Insulating gloves complete with leather protectors provide arc flash protection due to the increase in material thickness, and are recognized by the CSA Z462 and NFPA 70E standards as providing adequate arc flash protection.
3. For shock protection, workers are normally to wear rubber insulated gloves with manufacturer supplied protectors (as a complete system) rated for the voltage exposure. Always wear protectors with your rubber insulated gloves when there is also an arc flash exposure.  
Rubber Insulating Glove classes:
  - Class 00 up to 500V AC/750V DC
  - Class 0 up to 1,000V AC/1,500V DC
  - Class 1 up to 7,500V AC/11,250V DC
  - Class 2 up to 17,000V AC/25,500V DC
  - Class 3 up to 26,500V AC/39,750V DC
  - Class 4 up to 36,000V AC/54,000V DC
4. Non-conductive safety glasses complete with side-shields shall always be worn under a face shield or Arc Flash Suit Hood. Note that safety glasses provide protection from projectiles which can be present in an arc flash incident, as well as protection from UV exposure.
5. Hard hats shall be Class E for all energized electrical work tasks.
6. Body worn jewelry, piercings, and metal framed glasses are not permitted to be worn when performing energized electrical work tasks.
7. For remote operating or racking tasks (where the worker is located outside of the arc flash boundary and/or the Electrical Work Zone), hearing protection is required since the sound waves will not be substantially attenuated if an arc flash occurs.

### **6.5.2 ELECTRICAL TOOLS & EQUIPMENT**

Table 1 provides a list of typical electrical safety tools and equipment required when working with energized electrical equipment and systems that are low or high voltage.

Electrical tools and equipment provided by contractors must meet and/or be certified to all applicable Standards for the task they are to be used for and be selected, stored, used, and maintained in accordance those standards.

The selection, specifications, storage, pre-use inspection and testing requirements for electrical safety tools and equipment used by Company personnel are outlined in Appendix I.



**Table 1**  
**Typical Electrical Safety Tools and Equipment**

<b>Tools and Equipment</b>	<b>Requirements</b>
Temporary Protective Grounds (e.g., ground clusters or cable sets)	Properly rated as per ASTM F855 and CAN/ULC – D 61230-99. Clamp or connection type as appropriate for the application.
Properly Rated Voltage Detector & Tester, for Low and High Voltage Applications	Low voltage and appropriate high voltage range detectors and testers are required to test for absence of voltage. High voltage testers are required to be mounted on a hot stick when testing for absence of voltage (i.e., hot stick compatible).
Digital Multi-Meter and Misc. Electrical Testers, Category IV, 600V	CSA or UL approved and/or to other applicable standards used for diagnostic testing and testing for absence of voltage. Meets the requirements of CSA C22.2. 1010 and/or ANSI/ISA Standard S82.02.01 and/or IES 61010 and/or UL 1244.
Hot Sticks (Live-line tools)	Fixed length, shotgun style (of various lengths) grip-all, telescopic or folding for use with voltage detectors or for attaching temporary protective grounds. Meets the requirements of ASTM F 711.
Static Discharge Stick	Meets the requirements of ASTM F711.
Insulated Hand Tool	Minimum tools required for most common work to be encountered. Special tools for unique work like disconnecting battery terminals or pulling or inserting fuses. Meets the requirements of ASTM F 1505.

**Notes:**

- 1 *All equipment shall be marked with CSA or UL approval and meet applicable standards as outlined in CSA Z462 or NFPA 70E.*
- 2 *Electrical safety tools and equipment listed above can be deployed using a shared or individual assigned system.*
- 3 *Electrical safety tools and equipment shall be supplied to Enbridge personnel under a management system which addresses items such as: storage locations, inventory, equipment identification and tagging, maintenance/testing/certification requirements, procurement and replacement/repair, assignment to personnel, tracking and records/documentation storage, and accountabilities/responsibilities.*
- 4 *Proximity-type voltage detectors do not work on shielded cable.*
- 5 *Pen style voltage detectors are not an approved method of voltage detection for testing for absence of voltage but are permitted for use as an additional check.*

## 6.6 ENERGIZED ELECTRICAL SAFE WORK PRACTICES

To perform energized electrical work tasks, various preventive and protective control measures to protect personnel from electrical hazards are provided in Appendix J.

## 6.7 HIGH VOLTAGE SUBSTATIONS

Enbridge is a non-utility that owns, operates, and maintains substation equipment and overhead power lines. Enbridge substation equipment is normally fed from third party Utility System Owner facilities which requires us to have coordinated safety policies and procedures with these electrical utilities. The electrical utility lines connect to our facilities through a connection point, then through a series of disconnects, circuit breakers, metering instruments, transformers, and cables/busses. Only Qualified Electrical Workers with high voltage training (QEWHV's) are authorized to perform switching and isolation procedures, and related operations and maintenance work tasks, on Enbridge owned high voltage substation equipment and power systems.

**Note:** Work activities should not be performed on substation equipment and power systems when lightning is in the area or when passing over lines entering or exiting the facility. Additional precautions are needed if precipitation is present.

The process of establishing various work areas, Electrical Work Zone, as well as establishing an Electrically Safe Work Condition at an Enbridge owned facility substation connected into a transmission or distribution grid owned by a Utility System Owner often involves more than one company. Multi-employer work sites have an increased likelihood of a work protection error and therefore additional precautions are warranted, so the following preventive and protective measures are listed in the following sections.

### 6.7.1 HIGH VOLTAGE SUBSTATION PRE-JOB PLANNING REQUIREMENTS:

Prior to performing any work, a pre-job planning meeting will be performed to verify all site and job specific information including:

- Utility Interconnection Agreement requirements, including review and verification of the Operator-In-Charge role, the QEWHV('s) role(s), Utility System Owner contacts, and communication and coordination protocols between parties for normal and emergency situations
- site specific work scope
- work crew and contractor scope, interface, supervision, as well as worker qualifications and necessary certifications
- site specific drawings and equipment nomenclature (Note: if required, escorted walk-downs shall be completed of the site/equipment involved in the work to physically and visually verify the exact equipment involved and its tagging and any special information pertaining to the condition, use, and operation of that equipment and the power system).
- switching orders and sequences
- authorized work areas and EWZ for crews and equipment

- perimeter management and access/security requirements
- site specific Control of Hazardous Energy procedures including use of the Electrical Switching and Work Clearance form (described later), lockout/tagout procedures/forms, and Guarantees of Isolation forms and procedures
- technical work procedures which will be used
- applicable Safe Work Permits, Job Hazard Assessments, and Field Level Hazard Assessments
- emergency response planning (in accordance with this standard and other policies and procedures) and setup (including review of emergency contacts and contact procedures)

Further details on some of the above items are provided below.

The lead QEWHV and supporting QEWHV's will review substation single line diagrams, plot plans, and the physical substation arrangement to identify and map out areas within the substation where various work crews and equipment are allowed during the work activities, as well as to establish Electrical Work Zones. These areas shall be clearly communicated to all workers and continuously managed and enforced throughout the work activities. Perimeter access and gates shall be controlled in order to keep unauthorized personnel and equipment out of the substation area.

It is critical to ensure that all parties (e.g., Utility System Owner, Enbridge personnel, contractor personnel, etc.) properly understand the switching orders and sequences, work tasks involved, details of a specific site, proper names for equipment, and use consistent and coordinated procedures. Therefore all substation plot plans, electrical single line diagrams, and other engineering drawings and equipment nomenclature shall be reviewed and verified before being utilized for electrical isolation in order to establish electrically safe work areas and Electrical Work Zones for various work crews and equipment and, if part of the work tasks, establishing an Electrically Safe Work Condition.

### **6.7.2 USE OF THE ENBRIDGE ELECTRICAL SWITCHING AND WORK CLEARANCE FORM**

Enbridge's Electrical Switching and Work Clearance form (see Appendix C) must be utilized for any isolations required at Enbridge owned high voltage substation equipment or power systems when:

- work activities are being performed by Enbridge or its Contractors on the Enbridge's high voltage substation equipment and power systems
- work activities are being performed by a third party to Enbridge on a Utility System Owners or Operators interconnected high voltage substation equipment or power systems. For the purpose of the requirements of this section, 3<sup>rd</sup> parties to Enbridge include the Utility System Owner or Operator and their Contractors.

Where third parties are performing work activities on a Utility System Owner or Operator's high voltage substation and power system, they must lockout/tagout any Enbridge isolating devices

required to be utilized for isolation of their work. The lockout shall be performed in accordance with Enbridge's lockout requirements contained within the Control of Hazardous Energy and/or Lockout/Tagout standards and policies (as applicable to LP and GTM). Similarly, when Enbridge or its Contractors are performing work activities on an Enbridge high voltage substation and power system, they must lockout/tagout any Utility System Owner or Operator's isolating devices required to be utilized for their isolation unless the Utility System Owner or Operator prohibits them from doing so. In such cases, the Utility System Owner or Operator must provide Enbridge or its Contractors a Guarantee of Isolation (GOI), or equivalent, in accordance with their applicable standard.

Enbridge has Utility Interconnection Agreements in place with Utility System Owners and/or Operators for the supply of their power. These are legal agreements that are managed and maintained by Enbridge's Energy Management Department (for LP) or other groups (for GTM). In many cases (not all), these Utility Interconnection Agreements contain safe operating agreements (e.g., Standard Operating Procedures, Memorandum of Understanding (MOU's), etc.) within them that establish the rules of engagement between the parties as it relates to operation, maintenance, and emergencies impacting the interconnected facilities. These safe operating agreements typically contain the following types of information:

- key contacts for both parties for use in planned outage coordination, emergencies and routine operations and maintenance,
- where required per the interconnection agreement, responsibilities of personnel from both parties fulfilling key roles associated with the agreement and operation and maintenance of their respective high voltage substations and power systems (i.e., Operator in Charge (OIC)),
- single line drawings of both party's substation facilities,
- the functional tag numbers of the primary switches to be used for isolation of both party's systems from one another, and
- any specific requirements and procedures for communication and isolation associated with operating and maintenance work on one's facilities having the potential to impact the other's facilities (includes details regarding isolation and provision of a Guarantee of Isolation (GOI)).

An up-to-date copy of the Utility Interconnection agreement and/or the safe operating agreement must be made readily available within, or in close proximity to, the Enbridge high voltage substation on site.

In cases where a safe operating agreement is not included or contained within an Interconnection Agreement, Enbridge's Power Utility Information Form (see '**Appendix H**') shall be completed and maintained. An up-to-date copy of the completed form must be made readily available within or in close proximity to the Enbridge high voltage substation on site. The form includes the following basic information:

- key contacts for both parties for use in planned outage coordination, emergencies and routine operations and maintenance
- the functional tag numbers of the primary switches to be used for isolation of both parties systems from one another.

### **Operator-in-Charge (OIC)**

Where required by interconnection agreements, regions will appoint one or more Operators-in-Charge for the high voltage substations and power systems owned by Enbridge within their Region. If more than one is identified, each Operator-in-Charge will be assigned to the substations within a distinct area within the Region. The individuals should be mid-level or front-line leaders or specialists and must be knowledgeable and experienced in the operation of high voltage substations and power systems and will also have a QEWHV qualification. The responsibilities of an Operator-in-Charge are to:

- Act as the main point of interface with the Utility System Owner per the requirements of the Utility Interconnection Agreement and/or safe operating agreement for the specific job.
- Ensure that a safe and properly coordinated switching and isolation procedure is in place with the Utility System Owner and is followed.
- Be familiar with and retain a copy of the up-to-date Utility Interconnection Agreements and any associated safe operating agreements in place for their assigned high voltage substation(s), ensure that a copy of these documents is available for the work team at the site,
- Provide input to Energy Management (or other stewarding group) of any changes or improvements necessary to help maintain the content of any safe operating agreements contained within Utility Interconnection Agreements,
- Monitor all conditions affecting the operation of the electrical system,
- Ensure electrical single line diagrams and other operational related diagrams/documents or equivalent devices indicating the operating condition of the electrical system are readily available and maintained up to date,
- Keep a suitable record of all changes in conditions affecting the electrical system.
- Maintain an up-to-date log of all personnel accessing the substation, their purpose and tasks performed, observations and findings, contact information, time, and date, and ensure that this log is available to all personnel planning work at this site in the event that someone needs to be contacted about some past condition or activity at the substation.
- Responsibilities may be unique to one site, or across a region, as required.

- Ensure a designate on site is established for any isolations and lockouts required to be coordinated with the Utility (may be the Lockout Authority (LP) or Responsible Employee/Operating Authority (GTM)).

A QEWHV will be assigned as a Lead for all electrical work in substations. The Lead will:

- Ensure employees or contractors working under their direction comply with the requirements of this standard; and
- Maintain all required records;
- Communicate with the Operator-In-Charge when required by the policies and procedures;
- Manage and authorize Temporary Power Certificates;
- Establish and manage work areas and EWZ and substation perimeter access controls;
- As far as reasonably possible prevent unauthorized persons from approaching places where work is being done and where hazardous conditions exist by the use of Danger tape, barricades, and Electrical Safety Watches;
- Prohibit the use of any tools or devices or equipment unsuited to the work (including ensuring that all tools and equipment are properly certified and fit for service). All tools and equipment entering the substation, work area, or into an EWZ (as applicable) are to be inventoried and discussed in a job briefing/tailgate meeting prior to the work being performed in the substation, work area, or Electrical Work Zone.

QEWHVs working under the direction of a designated Lead will be responsible for:

- Working safely on energized electrical equipment or lines;
- Undertaking all maintenance work tasks assigned to them by the designated Lead; and
- If it is an emergency, can perform work tasks without first receiving authorization from the designated Lead.

#### **Accessing Substations for Electrical Work**

Before accessing a high voltage substation for electrical work, a QEWHV must complete an FLHA. The following general rules and policies apply with respect to access and work management in the high voltage substation:

- QEWHVs are authorized to enter the substation. Any other worker shall be escorted and supervised at all times by an authorized QEWHV.
- When energized electrical work is completed in the high voltage substation, at a minimum two (2) QEWHVs are required. One of the QEWHVs will be designated as the Lead QEWHV in charge for executing the assigned work task.

- When maintenance work tasks are required in the substation that are not energized work tasks, but relate to snow removal, or vegetation management, or other similar non-electrical maintenance tasks (e.g., painting) a QEWHV must instruct the non-qualified workers on the Limits of Approach or Minimum Approach Distances and will directly supervise the work as it is completed. Where the safety of the non-qualified workers can be managed by the QEWHV without the QEWHV's continuous presence (for example, by using restricted work areas and/or task restrictions), then the unqualified workers can be left unsupervised for an appropriate period of time.
- QEWHVs will adhere to the appropriate Limits of Approach or Minimum Approach Distances at all times when inside the energized high voltage substation and related to authorized energized electrical work.
- If any Abnormal Operating Condition is identified while workers are inside the energized high voltage substation, then they must evacuate the substation and muster at the approved muster point and contact the Enbridge Operator-in-Charge.
- The established Risk Assessment Process/Procedure shall be followed before energized electrical work tasks are executed. Special approvals may be required for "High Risk" work tasks.
- An Energized Electrical Work Permit (EERP) may be required before the energized electrical work task is executed.
- Before unlocking the main gate for vehicle access or personnel access, inspect the gate and fencing for broken ground straps; and visually search the substation for broken insulators, downed conductors, arcing connections, or abnormal sounds within the substation.
- Inspect signage located on the access gate(s) and ensure that it is legible and properly secured. Pay attention to any special signage and related requirements. If there is damage to the gate or fencing, or any evidence of impending failure in the substation yard, close the gate or place red "Danger" tape across the entrance once entry is made to keep unauthorized persons from entering.

Established processes and documentation related to Switching & Isolation Orders and procedures shall be followed before completing any repair or alteration work tasks. This may include the use of a Guarantee of Isolation (GOI) and a Guarantee of Isolation Return (GOIR) as applicable to the specific Utility Interconnecting Agreement or utility's policies.

Additional requirements include (see Appendix J for additional substation related work practices):

- Required work shall be completed with the use of switching diagrams and one-lines, showing the arrangement and location of electrical equipment and lines.
- Procedures and/or Job Hazard Assessments (JHA's) will be used for the operation, isolation and maintenance of electrical equipment and lines.
- Procedures shall be used outlining the application and use of temporary protective grounding that ensures that QEWHVs working on isolated and grounded electrical



equipment or lines are not subjected to hazardous potentials. The procedures detail the steps necessary to safely apply temporary protective grounds to isolate the high voltage circuitry and temporarily ground the circuit being worked on to eliminate hazardous potential voltages.

- The QEWHVs must ensure that switching diagrams (or equivalent devices such as mimic panels, human machine interfaces (HMIs), or graphical switching panelboards), as well as operating procedures, and procedures outlining the application and use of temporary protective grounding, are always kept up-to-date.

## 6.8 WORKING ALONE

Prior to assigning work, a determination must be made if working alone is acceptable. When working alone is authorized, the worker and their People Leader must establish a means of communication and assistance.

Qualified Electrical Workers, Task Qualified Workers or Qualified Instrumentation Workers can perform an energized electrical work task alone. The minimum requirements of LP's Working Alone Safety Standard (LP) or Health and Safety Manual Section 4.47 (GTM) shall be followed.

Consult the risk register for when Electrical Safety Watches are required.

## 6.9 LOOK-ALIKE EQUIPMENT

Electrical equipment installations are constructed of materials of similar size, shape, construction, and color. This look-alike equipment presents a risk of injury to a Qualified Electrical Worker if not adequately identified. The worker may lose track of the equipment being worked on and inadvertently attempt to work on another similar piece of equipment that is in an energized state. In order to avoid the hazard and associated risk of working on the wrong equipment, Qualified Electrical Workers should consider placement of temporary warning signs or use tape or ribbons on any look-alike equipment in close proximity to the work area. This will alert the worker of the hazard of the look-alike equipment and reduce the risk of inadvertently attempting to work on it or accessing it while in an energized state.

Appropriate permanent identification shall be added to the front and (where possible) back of electrical power distribution equipment being installed to further avoid the risk of human error of incorrectly identifying the wrong equipment that may still be energized.

## 6.10 TEMPORARY POWER SYSTEMS

When temporary power distribution systems are required during construction, facility shutdowns, or when the normal power system is not available to source power, precautions are to be taken to ensure that the installed temporary power distribution systems do not expose workers to the electrical hazards of arc flash and shock.



At a minimum the requirements of *Section 76 of the CEC Part 1* and *NEC Article 590* shall be met for any temporary power distribution system(s).

A Temporary Power Certificate shall be completed and submitted to the Supervisor or Operator-in-Charge for approval. The Temporary Power Certificate will expire in 12 months from issue and requires inspections to be performed every 90 days. The form should be uniquely numbered for tracking purposes. See Appendix G for a sample of the form.

Temporary power distribution systems should be kept in service for the shortest time possible. Maximum duration should not exceed one year. If the timeframe is to be extended, then the entire power distribution system must be inspected and re-approved and a new Temporary Power Certificate issued.

Where portable power generators are used, they shall be installed to the manufacturer's requirements and bonded to ground.

All equipment used in the temporary power distribution system shall be protected by suitable barriers so that vehicles and other construction or maintenance equipment do not damage it and expose workers to arc flash and shock hazards.

Temporary power distribution cables shall be protected from damage by ensuring they are routed away from high traffic areas. Where this is not possible, mechanical protection must be provided (e.g., wooden covers, plastic cable troughs, pipe, suspended above ground, etc.). When cables are suspended above ground ensure they are high enough to avoid encroachment by vehicles or other construction equipment or routed where vehicles are not permitted to go. Signalling with tape and flags may be required for cables that are suspended above ground.

If insulated temporary power cables have to be routed across roads, as an additional precaution they must be routed high enough to avoid encroachment by vehicles into the Limited Approach Boundary for movable conductors in *CSA Z462 Table 1A or 1B* or *NFPA 70E Table 130.4(D)(a) or Table 130.4(D)(b)*.

All temporary power distribution equipment must be suitably bonded to ground.

Before energizing the temporary power distribution system, the electrical protective devices used shall be checked to ensure that the disconnect switches, circuit breakers, fuses and relays are in good condition and suitably rated for the duty.

When energized electrical work is required to be performed on temporary power distribution systems the electrical risk assessment requirements of this standard are required to be completed.

Where needed, sketches, drawings, manuals, pictures, and other documentation should be collected and/or created in order to support operation, maintenance, and any required electrical risk assessments for the temporary power system. Often the PPE Category Table method from CSA Z462 or NFPA 70E can be used for arc flash risk assessments, but if necessary, an arc flash study can be prepared. Consult with engineering support for advisement.

## 6.11 ELECTRICAL SAFETY PROGRAM ASSESSMENT

Assessments of compliance and the effectiveness of implementation of the electrical safety program and the requirements of this standard are to be performed using self-assessments which include the completion of regular work practice inspections and safety observations. These assessments of compliance are also to include provisions for periodic program assessments achieved through completion of interviews, inspections/observations, and documentation reviews. Corrective actions arising from such assessments serve as a critical component for continuous improvement of the Electrical Safety Standard.

## 6.12 POST SERVICE EQUIPMENT RE-ENERGIZATION AND POST FAULT RE-ENERGIZATION PROCEDURE

When energizing equipment for the first time after inspections, servicing, repairs, or tests, CSA Z462 and NFPA 70E identify that there is a slightly higher risk of an arc flash incident. A specific work task for this situation has been created in the risk register and an arc flash hazard has been specified for this task. Refer to the Energized Electrical Risk Register for requirements for this task.

Note: when performing switching under normal equipment conditions, no arc flash hazard is present. The work task mentioned in the previous paragraph has an associated arc flash hazard present for the FIRST TIME ONLY after service work - possibly due to a tool being left in the equipment, misalignment, improper adjustment or contamination during the servicing.

For LP only: the Enbridge Post Fault Return to Service Guidelines shall be followed when returning impacted equipment to regular service following any electrical fault or event and the associated assessment and repair of any damage to the equipment. Copies of these guidelines are posted at facilities across the system.

## 6.13 ELECTRICAL EVENTS AND REPORTING

Employees and contractors shall report all electrical events.

An electrical event is defined as any of the following:

- Any event where a person is injured by an Electrical Shock, Arc Flash, or associated Arc Blast;
- Any event where electrical equipment fails in a manner that did or could have reasonably been expected to injure a person, damage equipment, or result in production loss;
- A near miss for any of the above.

It is a requirement of this ESS that:

- All electrical shocks, no matter what voltage level shall be reported.

- All electrical faults and arc flash events shall be reported.

For LP: See the OMM Book 1 Event Reporting, Subject 02-02-01 (Canada) or Subject 02-02-02 (US) for further Event Reporting Requirements. The reporting tables contained within these documents shall include any reporting requirements established by the authority having jurisdiction for the Canadian Electrical Code in Canada or National Electrical Code in the US.

For GTM: See the Canada GTM Incident Reporting Guide or US GTM Incident Reporting Guide for any required reporting to the authorities having jurisdiction. These documents provide equivalent information to the LP OMM Book 1 documents referenced above.

Electrical events shall be analyzed in accordance with the requirements of the various applicable Enbridge Event Analysis processes, guidelines, and health and safety standards.

## 6.14 ELECTRICAL EMERGENCY RESPONSE

Workers exposed to electrical hazards are to be trained in methods of release of victims from contact with exposed energized electrical conductors or circuit parts. This should include emergency isolation procedures and the use of approved insulating or insulated PPE and tools.

Workers who will be involved in energized electrical work tasks, and those acting as Electrical Safety Watches or otherwise supporting those work tasks, shall be trained in the principles and procedures of electrical emergency response, and also trained using practical onsite emergency response scenario training exercises and simulations. For continuous improvement, any findings from those training exercises shall be documented, reviewed, and changes implemented as necessary.

Only those workers authorized to do so and with the proper training mentioned above shall undertake electrical emergency response rescue.

Where required, an Electrical Safety Watch assigned to electrical work should have access to and training on how to use the main breaker or other power shutoff/isolation equipment, an approved fire extinguisher for electrical fires, working radio or access to a phone for communication, information on work location and directions to site, a working flashlight available, and immediate access to an Automatic External Defibrillator (AED). A rescue tether, rescue stick, shepherds rescue hook or hot stick and rubber insulating gloves may also be required for certain applications (e.g., during execution of energized electrical work, etc.). If emergency lighting is installed it shall be checked to ensure it is functional. See also Appendix A – content on the Electrical Safety Watch worker role.

**Never attempt to rescue a victim of an electrical event without de-energizing the electrical system first or suitably protecting the person that would attempt to rescue the victim!**

The risk of exposure to electrical hazards shall be eliminated before rescue is attempted. *The Methods of Release* section below identifies approved methods that authorized workers can use to rescue a shock victim when they are working on or near electrical power distribution equipment.

### 6.14.1 METHODS OF RELEASE

Approved methods of release shall be utilized by the authorized worker completing the rescue, the three methods available are (in order of preference):

- Turn off the power by identifying the appropriate main breaker or switch and opening it;
- Rescue the victim using an escape tether (vest mounted or embedded in an arc flash suit), rescue stick, shepherd's rescue hook, or hot stick;
- Use rubber insulated gloves and ensure that the rescuers' body doesn't make contact with the victim, only the gloved hands.

**Note:** Other methods such as using wood, running tackle, or throwing an object at the victim are not approved for use; they may expose the rescuer or the victim to additional hazards.

## 7.0 TRAINING REQUIREMENTS

Electrical safety and safety related technical training is required for all applicable employees or contractors who face a risk of exposure to electrical hazards including electric shock, arc flash and associated arc blast. The amount of training and the topics covered should be appropriate for the roles, responsibilities and expected activities of each worker.

See Appendix J for various electrical safety work practices. These requirements are to be included in the various electrical safety training courses as applicable to the course and worker role.

Reference the Health & Safety training syllabi and matrices for further information and training re-certification requirements.

## 8.0 STANDARD REVIEW

Safety Shared Services will contact EESAT on a three-year cycle (aligned with the CSA Z462 and NFPA 70E code cycle updates) for reviewing this standard.

Other updates may be required based upon need, changes can also be communicated on an as needed basis as an interim measure and "batched up" for the next regular update cycle.

A subject matter expert (SME) from the EESAT will perform a technical review of this standard every two years to determine the accuracy of the content/information. The SME shall solicit input from applicable stakeholders to ensure the effectiveness of the standard. Any suggested changes must be reviewed and approved by the designated document owner.

## **9.0 REFERENCES**

### **CANADA:**

Canada Occupational Health and Safety Regulations (SOR/86-304 Part VIII – Electrical Safety)

Applicable Provincial Occupational Health and Safety Codes

CAN/CSA-C22.1 Canadian Electrical Code (CEC) Part 1

CAN/CSA-C22.3 No. 1 Overhead Systems

CAN/CSA-C22.3 No. 7 Underground Systems

CSA Z462 Workplace Electrical Safety Standard

CSA Z463 Maintenance of Electrical Systems Standard

CAN/ULC S801 Standard on Electric Utility Workplace, Electrical Safety for Generation, Transmission and Distribution Alberta Electrical Utility Code (AEUC)

### **USA:**

29 CFR 1910.269 Occupational Safety and Health Standards, Subpart R – Special Industries, Electrical Power Generation, Transmission and Distribution

29 CFR 1910.301-399 Occupational Safety and Health Standards, Subpart S – Electrical

29 CFR 1926.400-449 Safety and Health Regulations for Construction, Subpart K – Electrical

NFPA 70 National Electrical Code (NEC)

NFPA 70B Recommended Practice for Electrical Equipment Maintenance

NFPA 70E Standard for Electrical Safety in the Workplace

### **International:**

IEEE C2 National Electrical Safety Code (NESC)

IEEE 1584 Guide for Performing Arc-Flash Hazard Calculations

ANSI/NETA MTS Standard for Maintenance Testing Specifications for Electrical Power Equipment and Systems

ANSI/NETA ATS Standard for Acceptance Testing Specifications for Electrical Power Equipment and Systems

## 10.0 APPENDIX

### 10.1 APPENDIX A – ELECTRICAL WORK TASKS BY QUALIFICATION CATEGORY

Category	Sub-Category	Authorized Work Tasks	Conditions/ Limitations
Qualified Electrical Worker (QEW) – Low & High Voltage	Minimum Journeyman Electrician– Canada  *Exception: Unless not required in a specific jurisdiction and approved by the Director of the Region or Project	Work on low voltage equipment.  Only QEW's with high voltage training can work on energized or de-energized high voltage systems including high voltage switching, metering, and relay protection and communication system related work tasks.	Journeyman and non-journeyman (the latter only in a jurisdiction where a certification is not required) electricians shall have demonstrated skills and knowledge related to the construction, commissioning, operation and maintenance of electrical equipment.  Specialized technical skills training is required for work on high voltage equipment.
	Qualified Electrician – USA	Work on low voltage equipment.  Only QEW's with high voltage training can work on energized or de-energized high voltage systems including high voltage switching, metering, and relay protection and communication system related work tasks.  Only QEW's with high voltage training can work on 2,300V – 230,000V high voltage substation equipment involving operation of high voltage circuit breakers or circuit switchers.	Shall have demonstrated skills and knowledge related to the construction, commissioning, operation and maintenance of electrical equipment.  Specialized technical skills training is required for work on high voltage equipment.



Category	Sub-Category	Authorized Work Tasks	Conditions/ Limitations
Qualified Electrical Worker (QEW) – Continued	Electrical Engineers & Electrical Engineering Technologists	Electrical acceptance and testing work tasks on low or high voltage systems.	Shall have demonstrated skills and knowledge related to the construction, commissioning, operation and maintenance of electrical equipment.  Specialized technical skills training is required for work on high voltage equipment.
	Power Line Technicians, Power System Electricians, Power Generation Technicians	Work on de-energized and energized high voltage equipment as part of generation, transmission, and distribution systems/facilities.  Voltage classes may vary but can be up to 1 MV AC or DC.	Shall have demonstrated skills and knowledge related to the construction, commissioning, operation and maintenance of electrical equipment.  Workers shall be trained and authorized to properly operate and maintain these specific facilities.  Specific qualifications will vary from jurisdiction to jurisdiction.  Specialized technical skills training is required for work on high voltage equipment.



Category	Sub-Category	Authorized Work Tasks	Conditions/ Limitations
Associate Electrical Worker (AEW)	Apprentice Electrician – Canada  Electrician in Training – USA	Work on low voltage and high voltage equipment as required, under direct supervision of a Qualified Electrical Worker.	Worker shall be adequately trained and validated as competent.  Work tasks shall be approved by, and under the direct supervision of, a Qualified Electrical Worker.  Specialized technical skills training is required for work on high voltage equipment.
Task Qualified Worker (TQW)	Examples: HVAC, Fire, Overhead Door, Crane, Elevator/Lift, Cathodic Protection System, Security, Communication, Measurement, Equipment Service or Factory (e.g., motor, VFD, transformer, etc.), Solar, and Wind Farm Technicians	Work tasks on de-energized and energized low voltage specialized systems such as HVAC systems, overhead doors, cranes, elevators, cathodic protection systems, security systems, communication equipment, measurement equipment, motors, VFD's, transformers, solar modules and control/management systems, wind turbine equipment/ power collection systems.  Troubleshooting and diagnostic related work tasks downstream of a local disconnect.  Typically, power supply wiring and grounding/bonding installation/wiring is not in the scope of a TQW, these	Worker shall be adequately trained and have required knowledge and experience to work safely.  The training and the certification of the worker may further limit the voltage for working on energized electrical work tasks to low voltage.  If equipment involved is high voltage, then knowledge/training/qualification requirements are the same as for Power Line Technicians, Power System Electricians, Power Generation Technicians for the specific equipment involved (see above) and work will be restricted to the specific equipment the TQW is qualified for.





Category	Sub-Category	Authorized Work Tasks	Conditions/ Limitations
		<p>are done by QEW's (electricians).</p> <p>Some equipment may be high voltage (motors, VFD's, transformers, etc.) so high voltage qualifications will also be required as for Power Line Technicians, Power System Electricians, Power Generation Technicians (see above), and work will be restricted to the specific equipment the TQW is qualified for.</p>	
<p>Qualified Instrumentation Worker (QIW)</p>	<p>Instrumentation Technician</p>	<p>Work on control systems and related equipment with an operating voltage not greater than 120V AC or 125V DC (nominal).</p>	<p>Per trades training or Enbridge's authorized scope.</p> <p>Some workers may be "dual ticketed" so may have qualifications and authorizations under the QEW role as well. Enbridge can authorize both QIW and QEW qualifications for an individual worker for the specific work role.</p> <p>Not allowed to work in Motor Control Centers unless authorized as a dual ticket QIW/QEW.</p>
<p>Qualified Operations Worker (QOW)</p>	<p>Mechanic, PLM Technician, Field Operator, Station Operator/Specialist, Team Lead Pipeline</p>	<p>Open or close low voltage branch circuit breakers or contactors up to 600 V AC or DC (US or Canada) to operate equipment for isolation purposes in</p>	<p>Equipment shall be in a normal operating condition.</p> <p>Must have Electrical Arc Flash and Shock Safety, Operational, and Technical training for</p>



Category	Sub-Category	Authorized Work Tasks	Conditions/ Limitations
<p>Qualified Operations Worker (QOW) – Continued</p>	<p>Technician, Power Generation Station Operators, etc.</p>	<p>preparation for mechanical equipment work tasks.</p> <p>480 V or 600 V switchgear rack in/out is NOT authorized.</p> <p>Reset low voltage (i.e., 240 V or less) circuit breakers only once after an over-current trip, and only after investigating and resolving the reason for the trip (scope limited to only a mechanical or process related issue). Get QEW support if the breaker still trips after the one attempt.</p> <p>Reset of overloads for 480 V or 600 V equipment can only be done if an external reset pushbutton is available and only after investigating and resolving the reason for the trip (scope limited to only a mechanical or process related issue). Get QEW support if the overload does not reset after one attempt.</p> <p>US Only (not permitted in Canada): Open or close high voltage (i.e., 2.3 kV, 4.16 kV, 6.9 kV, 13.2 kV, or 13.8 kV) branch motor isolation power circuit breakers or disconnect switches to operate equipment for isolation purposes in preparation for</p>	<p>operation of low voltage or high voltage isolation devices.</p> <p>High Voltage Electrical Arc Flash and Shock Safety Training is required for operation of high voltage isolation devices.</p> <p>Shall have appropriate site-specific training on the task and will review and follow an approved readily available site-specific procedure for Operation of low voltage and high voltage breakers and switches.</p> <p>Training must be documented and tracked within the training tracking system.</p> <p>Do not open hinged doors or remove covers on energized electrical equipment with exposed conductors or circuit parts.</p> <p>Do not perform any electrical work other than operating electrical equipment as defined here. Always engage support from a QEW for any troubleshooting or diagnostic work tasks on electrical equipment.</p> <p>Do not reset electrical protective relay trips.</p> <p>Do not reset an overload condition, except as noted in the Authorized Work Tasks</p>



Category	Sub-Category	Authorized Work Tasks	Conditions/ Limitations
<p>Qualified Operations Worker (QOW) – Continued</p>		<p>mechanical or process equipment work tasks.</p> <p>Rack-in/rack-out power circuit breakers is NOT permitted, except for Power Generation Station Operators working within the scope of their qualifications.</p>	<p>column for low voltage equipment.</p> <p>Where a remote operating tool is provided for high voltage circuit breakers it can be used by the QOW. It shall be compatible with the electrical equipment, and training will be provided in its use. If applicable, it shall be properly mounted, installed, and used per manufacturer’s instructions, and it can be installed by the QOW if properly trained – but the tool must be mountable and usable without opening the door or cover; or it can be of integral design. If an umbilical cord or wireless connection is used for operation, then perform operations, at a minimum, outside of the arc flash boundary of the involved equipment. Note: it is preferred to go to the maximum available umbilical length or wireless range if possible if that distance exceeds the arc flash boundary distance. Time delayed switches are also permissible for use – the QOW is to go outside the AFB (as a minimum distance) before the switch times out and operates.</p> <p>Operation of remote racking tools is not permitted.</p> <p>Insertion or removal of high voltage contactors is not permitted.</p>



Category	Sub-Category	Authorized Work Tasks	Conditions/ Limitations
Non-Electrical Workers (NEW)	Enbridge employees, contractors, visitors, etc. with no specific electrical qualification.	<p>Can complete a single reset 120V AC circuit breakers in work environment (one time only, and only after investigating the cause of the trip, and the cause must be mechanical or process in nature).</p> <p>If overload does not reset after one attempt, then stop work and get assistance from a QEW.</p>	<p>Root cause of trip shall be investigated and mitigated.</p> <p>Can only complete a single reset.</p> <p>When any energized electrical work is being conducted by QEW's the NEW shall not encroach on the Limited Approach and Arc Flash Boundary unless required PPE is worn, training has been provided on its use, and the NEW is under the supervision of a QEW.</p>
Electrical Safety Watch (ESW)	<p>First choice: QEW</p> <p>Second choice: TQW or QOW</p>	<p>First choice – (preferred) for planned work or at the discretion of the QEW - the Electrical Safety Watch is to be a QEW with appropriate Electrical Safety Watch training and first aid/CPR/AED qualifications, trained in the use of arc flash and shock PPE/tools, be able to identify and shut off power, trained in methods of release and principles of electrical emergency response and be able to effect rescue per the Emergency Response section of this Standard, use a fire extinguisher, notify emergency services and able to call for help/ trigger emergency response.</p>	<p>Electrical Safety Watches are dedicated to the safety watch role and are not to be performing the work task itself. If additional help is needed in order to perform an electrical work task, then another QEW shall be engaged for this.</p> <p>Electrical Safety Watches may also be required to enforce the work area perimeter (Electrical Work Zone) to keep unauthorized personnel from entering the work area or interfering with or distracting the QEW's performing the work.</p> <p>ESW's must stay outside of the Arc Flash Boundary (at a minimum) at all times unless an event has occurred and rescue is required.</p>



Category	Sub-Category	Authorized Work Tasks	Conditions/ Limitations
Electrical Safety Watch (ESW) – Continued		<p>Second choice – if a QEW is not available to serve as an ESW (for example, for emergency work, off-hours work, or at remote locations), then a non-QEW can be used as an Electrical Safety Watch. The QEW planning or performing the work task is to review the Electrical Safety Watch’s specific qualifications and abilities to determine any scope limitations or develop alternative procedures or approaches. Minimum capabilities are having first aid/CPR/AED, trained in the use of arc flash and shock PPE/tools (can be done at the time of the work), being able to identify and shut off power (verify at the time of the work), use a fire extinguisher, able to call for help/trigger emergency response.</p>	<p>Emergency or portable lighting is required in the event of a power outage and if the work area will be dark during a power outage (e.g., flashlight).</p> <p>The ESW shall be equipped with properly rated arc flash and shock PPE with additional access to the working QEW’s rescue tether; along with shepherds hook, hot sticks, or other certified insulated rescue means according to what is available at the site.</p> <p>Consult with the electrical work task risk register for specific work tasks requiring an ESW. Generally an ESW is required when an Energized Electrical Work Permit is being used, in some cases where equipment is in an abnormal condition, and/or at the discretion of the QEW’s performing the work.</p> <p>For large jobs and/or in high voltage substation work, multiple ESW’s may be required, each with a designated area of coverage.</p> <p>For emergency isolation, the ESW shall be trained on and able to isolate the power system at the appropriate location in the event of an emergency.</p> <p>Consult with the ESS Section 6.14 Electrical Emergency</p>



---

Category	Sub-Category	Authorized Work Tasks	Conditions/ Limitations
			Response for additional requirements.

10.2 APPENDIX B – TEMPORARY PROTECTIVE GROUNDING SIGN



*Note: 6"x10" Magnetic Sign*



10.3 APPENDIX C – ELECTRICAL SWITCHING AND WORK CLEARANCE FORM

ENBRIDGE		Electrical Switching & Work Clearance Form			
SUPPORTING DOCUMENT: Form Guidance (A-F)					
This form is only to be used when providing grounds on high voltage and upstream of the 480V/600V main breaker.					SWP#: _____
<b>1) PREPARATION &amp; PLANNING</b>					
Date of Work:	_____	Location of Work:	_____	Start Time/Date:	_____
End Time/Date:	_____	Equipment Out-of-Service:	_____	Voltage:	_____
<input type="checkbox"/> Review Single Line Drawing		LOTO Set #: _____			
Scope of Work*: _____		COPAS #: _____			
If scope of work changes, a new form is required.					
Name of person(s) completing this form: _____		Affected Groups & CCC: _____			
Lockout Authority Name: _____		<input type="checkbox"/> Work will continue on additional shifts			
Lockout Authority Phone #: _____					
<b>2) NOTIFICATION</b>					
<input type="checkbox"/> All affected personnel/departments have been notified					
<b>3) EQUIPMENT NEEDED (Indicate # of each used)</b>					
lockboxes:	_____	personal locks:	_____	grounds:	_____
applied ground signs:	_____	other: _____			
<b>4) ELECTRICAL ISOLATION &amp; LOTO</b>					
Isolation switching procedure on next page >>>					
<b>5) TEST FOR POTENTIAL</b>					
Test Meter on Known Live Sources		Test on De-Energized Circuit		Re-Test Meter on Known Live Sources	
Location	Time	Location	Time	Location	Time
_____	_____	_____	_____	_____	_____
_____	_____	_____	_____	_____	_____
_____	_____	_____	_____	_____	_____
<b>6) APPLY GROUNDS, APPLY GROUND SIGNS (verify with Single Line Drawing)</b>					
Ground Sets	Location of Ground Sets & Signs			Time On	Initials
1)	_____	_____	_____	_____	_____
2)	_____	_____	_____	_____	_____
3)	_____	_____	_____	_____	_____
4)	_____	_____	_____	_____	_____
Additional hazards and controls (if an outside service hold (guarantee) is required, provide number below):					
<input type="checkbox"/> Generators		<input type="checkbox"/> Tie Lines			
<input type="checkbox"/> Energized Issues		<input type="checkbox"/> Back Feeds			
<input type="checkbox"/> Other		<input type="checkbox"/> Switches			
<b>7) ISSUE OF WORK CLEARANCE</b>					
Name		Signature		Date/Time	
Issuer (Enbridge Lock Out Authority)		_____		_____	
Person in Charge of Work		_____		_____	
All other workers must sign in/out on next page >>>					
<b>8) WORK COMPLETE / PEOPLE AND TOOLS CLEAR</b>					
<input type="checkbox"/> All work on equipment has ceased and communicated to all workers.					
<input type="checkbox"/> All personnel have been advised and tools are accounted for.					
<input type="checkbox"/> All appropriate personnel have been advised to consider equipment energized.					
<b>9) SURRENDER OF WORK CLEARANCE</b>					
Name		Signature		Date/Time	
Issuer (Enbridge Lock Out Authority)		_____		_____	
Person in Charge of Work		_____		_____	
<b>10) REMOVE GROUND SETS -- location(s) listed in 6) APPLY GROUNDS</b>					
Ground sets removed	Number of sets: _____	If ground sets are not being removed and the equipment will remain out of service, explain why: _____			
Name		Signature		Date/Time	
Enbridge Lock Out Authority		_____		_____	
<b>11) REMOVE LOTO AND RE-ENERGIZE</b>					
<input type="checkbox"/> Ground sets have been removed and all areas of the form have been completed.					
<input type="checkbox"/> All locks are removed, and personnel have signed off.					
<input type="checkbox"/> All equipment is restored and re-energized.					
Name		Signature		Date/Time	
Enbridge Lock Out Authority		_____		_____	
Re-energization switching procedure on next page >>>					





**ENBRIDGE** **Electrical Switching & Work Clearance Form**

SUPPORTING DOCUMENT: Form Guidance (A1)

ISOLATION SWITCHING PROCEDURE					
Step #	Switching Step Description (including functional tag ID of isolation device)	Initials	Lock Set #	Interlock Key	Time Step Completed

RE-ENERGIZATION SWITCHING PROCEDURE					
Step #	Switching Step Description	Initials	Lock Set #	Interlock Key	Time Step Completed

WORKERS ON THE JOB - SIGN IN AND SIGN OUT				
Worker	Sign In	Date/Time	Sign Out	Date/Time



10.4 APPENDIX D – ELECTRICAL WORK TASK RISK REGISTER SUMMARY

Note: the complete latest version of the Electrical Work Task Risk Register document is available in the LP Governance Document Library. The full document also contains instructions for use, an indexing system for ease of reference, supporting assumptions, task specific heat mapping, and other supporting information. Snapshots are provided below for convenient reference.

Reviewed	Work Task Description	Equipment Condition Assumptions (Refer to the Assumptions & Notes tab for additional assumptions)	Energized Electrical Work (Per ESS Definition)	Arc Flash or Shock Hazard Present?	Arc Flash PPE required (as per NFPA & CSA Standards) for Shock PPE Tools & Equipment	Energized Electrical Work Permit (EERP) Required	Can Qualified Operations Worker (QOW) perform task?	Electrical Safety Watch	Notes
1A	Reading a panel meter while operating a meter switch (includes digital meters)	Normal	No	No	Minimum Enbridge Std PPE ESP Level 0	No	Yes	No	No incident because no interaction
				No	Minimum Enbridge Std PPE ESP Level 0				No incident because no interaction
1B	FIRST TIME ONLY AFTER SERVICING: Local or remote operation of a circuit breaker (CB), switch, contactor or starter after installation, completion of work, commissioning, or maintenance in the equipment. See Comments.	Normal	No	Arc Flash	Arc Flash PPE as determined by incident energy level.	No	No	No	The "First time only after servicing" task is added due to NFPA 70E and CSA 2462 updates, and requires wearing properly rated arc flash PPE when energizing equipment even for equipment in a normal operating condition. It reflects a slightly higher risk of equipment failure after servicing due to the possibility of tools being left inside, mis-alignments, loose components, residual contamination, etc. It can be applied in conjunction with several work tasks in this risk register - assess for the specific work task to determine if this "work task" applies to your situation. QOW's cannot perform this "first time only after servicing" task - equipment is to be re-energized by a QEW. A safety watch may be considered when restarting more complex equipment, and/or subject to location and availability of a safety watch.
				No	Minimum Enbridge Std PPE ESP Level 0				ESS definition of energized work does not include switching or operation of electrical equipment in a normal operating condition since doors are closed and there is no crossing of the restricted approach boundary or direct interaction of the worker with internal components, even though the equipment itself is energized.
1C	Local or remote operation of a low voltage circuit breaker (CB), switch, contactor or starter	Normal	No	No	Minimum Enbridge Std PPE ESP Level 0	No	Yes	No	ESS definition of energized work does not include switching or operation of electrical equipment in a normal operating condition since doors are closed and there is no crossing of the restricted approach boundary or direct interaction of the worker with internal components, even though the equipment itself is energized.
				No	Minimum Enbridge Std PPE ESP Level 0				
1D	Local operation of high voltage power circuit breaker (CB) in arc resistant switchgear	Normal	No	No	Minimum Enbridge Std PPE ESP Level 0	No	CAN - No US - Yes	No	All doors closed and all covers in place and fully bolted/fastened (as applicable to the specific equipment). No personnel within 10' of any arc flash plenum exhaust openings. Not permitted in Canada for QOW's due to trade regulations.
				No	Minimum Enbridge Std PPE ESP Level 0				
1E	Remote operation of high voltage power circuit breaker (CB) in non-arc resistant switchgear	Normal	No	No	Minimum Enbridge Std PPE ESP Level 0	No	CAN - No US - Yes	No	Use remote operating device or control system or time delayed operation device (chicken switch). Remote operating device can be installed by properly trained QOW per manufacturer's instructions, but only if no doors or covers need to be removed in order to install or operate. This task includes gear with SF6 bottles. Not permitted in Canada for QOW's due to trade regulations.
				No	Minimum Enbridge Std PPE ESP Level 0				
1F	Local operation of high voltage power circuit breaker (CB) in non-arc resistant switchgear	Normal	No	No	Minimum Enbridge Std PPE ESP Level 0	No	CAN - No US - Yes	No	Includes equipment with SF6 bottles. For open door operation of breakers (eg - old mechanically powered breakers with pump action and onboard pushbuttons requiring doors to be open in order to access the pushbuttons/pump handle, then Limited approach boundaries (36") would be in effect and QOW's would not be allowed to operate these breaker styles. Note to QOW's: Remember that this is for NORMAL operating condition only - remember to look, listen, smell, and feel for any abnormal conditions or equipment behaviour and if evidence of abnormal conditions then do not operate and consult with a QEW for appropriate actions. Not permitted in Canada for QOW's due to trade regulations.
				No	Minimum Enbridge Std PPE ESP Level 0				



Reviewed	Work Task Description	Equipment Condition Assumptions (Refer to the Assumptions & Notes tab for additional assumptions)	Energized Electrical Work (Per ESS Definition)	Arc Flash or Shock Hazard Present?	Arc Flash PPE required (as per NFPA & CSA Standards) or Shock PPE Tools & Equipment	Energized Electrical Work Permit (EEWP) Required	Can Qualified Operations Worker (QOW) perform task?	Electrical Safety Watch	Notes
1G	Remote operation of a high voltage disconnect switch, contactor, or motor starter non-arc resistant switchgear.	Normal	No	No	Minimum Enbridge Std PPE ESP Level 0	No	CAN - No US - Yes	No	
				No	Minimum Enbridge Std PPE ESP Level 0				
1H	Local operation of a high voltage disconnect switch, contactor or motor starter non-arc resistant switchgear.	Normal	No	No	Minimum Enbridge Std PPE ESP Level 0	No	CAN - No US - Yes	No	
				No	Minimum Enbridge Std PPE ESP Level 0				
1I	Insertion or removal (manual and local racking) of withdrawable low or high voltage CBs or HV switchgear starters from cubicles - doors open or closed	Normal	Yes	Arc Flash	Arc Flash PPE as determined by incident energy level.	No	No	Yes, for energized upline or downline bus connections. At QEW discretion for de-energized upline and downline bus connections.	For mechanical work only on the supplied equipment - do not need to withdraw the CB, only switching off is required (along with regular LOTO bump tests and other procedures). For electrical work on the power circuits to (or on) the supplied loads or motor - then breaker withdrawal to obtain visual guarantee of isolation is required (among other actions per the ESS section on Establishing an Electrically Safe Work Condition). If possible, and if acceptable to Operations, ensure that power is removed from both sides of the breaker's connections prior to the breaker being withdrawn. Breaker equipment and connections is designed to accommodate unloaded but energized withdrawal, but by de-energization an enhanced measure of safety is obtained. Upline de-energization can be obtained from a higher level switch or breaker, or Guarantee of Isolation from the electrical utility. Where de-energization of both sides of the breaker's connections is not possible, an ESW is required.
				No	Minimum Enbridge Std PPE ESP Level 0				
1J	Insertion or removal (remote operation) of withdrawable low or high voltage CBs or HV switchgear starters from cubicles - doors open or closed	Normal	No	No	Minimum Enbridge Std PPE ESP Level 0, plus hearing protection.	No	No	No	Installation and operation of remote racking equipment must be done by QEW's. Hearing protection required. Worker is to be located outside of the arc flash boundary or at a greater distance if possible.
				No	Minimum Enbridge Std PPE ESP Level 0				
1K	Insertion or removal of high voltage transformer or control power transformer compartments (arc resistant and non-arc resistant)	Any	Yes	Arc Flash	Arc Flash PPE as determined by incident energy level.	No	No	Yes, for energized upline or downline bus connections	Similar to manual/local racking. Physical action may be racking or manually withdrawing or inserting. This task applies to both arc resistant or non-arc-resistant equipment.
1L	Application of temporary protective grounding (TPG) equipment on low and high voltage, after test for absence of voltage.	Any	Yes	Arc Flash	Minimum Enbridge Std PPE ESP Level 0	No	No	At QEW discretion.	Shock/arc flash potential is due to any residual induced or stray voltages which may remain on the buses/conductors after switched de-energization and test for absence of voltage and cannot be fully drained until the TPG's are installed; or inadvertent energization due to erroneous reclosure of supply between testing for absence of voltage and application of TPG's. Standard procedure is to wear all arc flash and shock PPE for the installation of TPG's, to protect against these possible scenarios. Protects from risk of inadvertent closure during the short period of time until the TPG's are installed. Reference CSA Z462 Table 2: any equipment condition likelihood of arc flash = yes. Note: Install magnetic grounds installed warning sign if possible. Some areas have green ground tags added to the LOTO tagging as an additional flag that TPG's have been installed.
				Shock	Shock PPE, tools & Equipment as required when inside Restricted Approach Boundary.				
1M	Outdoor HV disconnect switch operation (hookstick operated) at 1 kV - 15kV	Normal	Yes	Arc Flash	Arc Flash PPE as determined by incident energy level.	No	No	No	Shock hazard present and shock PPE required because of using hookstick which may not be in perfect condition/weather, etc. Worker's body may, in some cases be getting near or crossing the restricted approach boundary. Arc flash PPE is not required if worker outside of the arc flash boundary, this will be situation specific.
				Shock	Shock PPE, tools & Equipment as required when inside Restricted Approach Boundary.				
1N	Outdoor HV disconnect switch operation (gang-operated, from grade) at 1 kV through 240 kV	Normal	Yes	Arc Flash	Arc Flash PPE as determined by incident energy level.	No	No	No	Shock protection (rubber insulated gloves with protectors) recommended for manual local operation in case of dirty connections or stray induced or capacitive voltages or lightning. Use glove class per arc flash and shock label, or per nominal voltage rating of the equipment, or highest available. If voltage exceeds maximum glove class available (Class 4 -36,000 VAC), then consider insulated boots. Typical switching equipment is bonded to ground, and workers feet are on a grounded (or floating) equipotential grid (ferm cage) located under crushed gravel beneath the worker's feet for additional protection. Site grounding designed to IEEE 80 standards or higher. Arc flash PPE also required per the arc flash and shock warning label if inside the arc flash boundary. These comments need to be validated/considered on a case by case basis as sites/equipment/grounding and site conditions may vary. Local weather conditions also to be considered at the time of the work task (eg: lightning/rain/snow/wind conditions) and may require temporary work stoppage or additional measures per Enbridge policies.
				No	Minimum Enbridge Std PPE ESP Level 0				



Reviewed	Work Task Description	Equipment Condition Assumptions (Refer to the Assumptions & Notes tab for additional assumptions)	Energized Electrical Work (Per ESS Definition)	Arc Flash or Shock Hazard Present?	Arc Flash PPE required (as per NFPA & CSA Standards) or Shock PPE Tools & Equipment	Energized Electrical Work Permit (EEWP) Required	Can Qualified Operations Worker (QOW) perform task?	Electrical Safety Watch	Notes
2A	Opening or closing HINGED covers for low voltage equipment such as wire ways, junction boxes and cable trays that DOES NOT EXPOSE bare, energized electrical conductors and circuit parts.	Normal	No	No	Minimum Enbridge Std PPE ESP Level 0	No	No	No	RIG's not required, but recommend wearing them when removing covers and checking inside for any abnormal conditions or damage or contamination. This task is commonly used for accessing internal of electrical equipment for various purposes such as visual/IR inspections, work planning and equipment assessment, and in preparation for servicing/testing/diagnostics. Use this task in conjunction with the other associated work tasks for the overall job.
				No	Minimum Enbridge Std PPE ESP Level 0				
2B	Opening or closing HINGED door(s) or cover(s) with EXPOSED LOW VOLTAGE BARE, ENERGIZED ELECTRICAL CONDUCTORS AND CIRCUIT PARTS on electrical equipment) and not crossing the restricted approach boundary.	Normal	Yes	No	Minimum Enbridge Std PPE ESP Level 0	No	No	No	This task is commonly used for accessing internals of electrical equipment for various purposes such as visual/IR inspections, work planning and equipment assessment, and in preparation for servicing/testing/diagnostics. Use this task in conjunction with the other associated work tasks for the overall job.
				No	Minimum Enbridge Std PPE ESP Level 0				
2C	Removal or installation of BOLTED covers with EXPOSED LOW VOLTAGE BARE, ENERGIZED ELECTRICAL CONDUCTORS AND CIRCUIT PARTS.	Any	Yes	Arc Flash	Arc Flash PPE as determined by incident energy level.	No	No	Yes, due to risk of falling bolts, and/or at QEW discretion.	For dc systems <600 VDC, this includes bolted covers, such as for some battery terminal covers or intercell covers (see assumptions tab for various shock and arc flash cutoffs for DC systems which may apply). Sites may have specific work procedures which apply to these DC systems which can eliminate the presence of an arc flash hazard by reducing voltage exposure (eg. system splitting switches or pre-assessed limited work areas in a large battery bank). Use this task in conjunction with the other associated work tasks for the overall job.
				Shock	Shock PPE, tools & Equipment as required when inside Restricted Approach Boundary.				
2D	Perform low or high voltage visual, infrared thermography, ultrasonic, partial discharge and other non-contact inspections outside the restricted approach boundary. This activity does not include opening of doors or covers.	Any	No	No	Minimum Enbridge Std PPE ESP Level 0	No	No	No	Use in conjunction with opening/closing doors and covers or bolted covers work tasks. Restricted approach boundary is not crossed in this task.
				No	Minimum Enbridge Std PPE ESP Level 0				
3A	For AC and DC systems, LV/HV: Work on energized electrical conductors and circuit parts, including voltage testing, current measurement, phasing, testing for absence of voltage, repair/alteration, etc.	Normal	Yes	Arc Flash	Arc Flash PPE as determined by incident energy level.	Repair or Alteration requires EEWP	No	Yes, for repair or alteration, and/or at QEW discretion.	This task does apply to DC charger, distribution, and protection equipment, but does not apply to battery equipment - refer to tasks related to battery equipment. The equipment in this task can be de-energized whereas DC batteries cannot be de-energized.
				Shock	Shock PPE, tools & Equipment as required when inside Restricted Approach Boundary.				
3B	Removal or installation of low voltage CBs, switches, or fuse replacements (NON-FINGERSAFE DESIGN) in energized electrical equipment (120 V, 208 V, or 240 V AC or up to 600 VDC).	Normal	Yes	Arc Flash	Arc Flash PPE as determined by incident energy level.	Yes	No	Yes, due to alteration, and/or at QEW discretion.	Added voltage limitations to typical 120/240 single phase or 120/208 V 3 phase AC lighting panels. Usually emergency panels. Also may be AC or DC. Note that the restricted approach boundary for 120 VAC is "avoid contact", and also has no arc flash hazard is present so RIG's would not be required if the worker can avoid contact. 208/240 VAC have a 12" RAB, so RIG's will be required, but check AFAS warning label to determine arc flash incident energy.
				Shock	Shock PPE, tools & Equipment as required when inside Restricted Approach Boundary.				
3C	Removal or installation of low voltage fuse replacements (FINGERSAFE DESIGN) in energized electrical equipment (120 V, 208 V, or 240 V AC or up to 600 VDC).	Normal	Yes	No	Minimum Enbridge Std PPE ESP Level 0	No	No	No	All covers and barriers to be in place and work task performed per manufacturer's instructions. Finger safe designs allow for fuses to be replaced while the buss is energized while still preventing any shock hazards by nature of the equipment design. Shows benefit of safety by design enhancements.
				No	Minimum Enbridge Std PPE ESP Level 0				
3D	Work on control circuits with exposed energized electrical conductors and circuit parts, 120VAC or below without any other exposed energized equipment >120VAC including opening of hinged covers to gain access	Any	Yes	No	Minimum Enbridge Std PPE ESP Level 0	No	No	No	Shock PPE for 120 VAC is "avoid contact". Check assumptions tab for voltages less than 120 VAC and associated cutoffs, although majority of our control circuits in MCC's and swgr will be 120 VAC (or less).
				Shock	Shock PPE, tools & Equipment as required when inside Restricted Approach Boundary.				
3E	Work on control circuits with exposed energized electrical conductors and circuit parts >120VAC (including some valve actuator components such as limit switches).	Any	Yes	Arc Flash	Arc Flash PPE as determined by incident energy level.	If repair or alteration then Yes	No	Yes, for repair or alteration, and/or at QEW discretion.	This would include setting limits of valve actuators that have exposed low voltage live conductors.
				Shock	Shock PPE, tools & Equipment as required when inside Restricted Approach Boundary.				
3F	Insertion or removal of individual starter buckets in a low voltage MCC	Normal	Yes	Arc Flash	Arc Flash PPE as determined by incident energy level.	Yes	No	Yes	Very rarely performed as shutdowns can normally be arranged for this work.
				Shock	Shock PPE, tools & Equipment as required when inside Restricted Approach Boundary.				



Reviewed	Work Task Description	Equipment Condition Assumptions (Refer to the Assumptions & Notes tab for additional assumptions)	Energized Electrical Work (Per ESS Definition)	Arc Flash or Shock Hazard Present?	Arc Flash PPE required (as per NFPA & CSA Standards) or Shock PPE Tools & Equipment	Energized Electrical Work Permit (EEWP) Required	Can Qualified Operations Worker (QOW) perform task?	Electrical Safety Watch	Notes
3G	For AC and DC systems. Work on exposed energized electrical conductors and circuit parts less than or equal to 125VDC/AC of utilization equipment directly supplied by an AC or DC power supply (power electronic or control power transformer) source (e.g. control systems, PLC, SWGR relay section, relays, SCADA, MCC control wiring, etc.)	Normal	Yes	No Shock	Minimum Enbridge Std PPE ESP Level 0 Shock PPE, tools & Equipment as required when inside Restricted Approach Boundary.	No	No	No	For shock, restricted approach boundary at 125 VDC or AC is "avoid contact". RIG's not required for normal conditions. Use insulated hand tools, meters, etc. to avoid shooting or damaging equipment or causing a shock to the worker. Indicated as "normal" in order to avoid any contamination situations (moisture, dust, etc.) which can be common at end devices. If abnormal, perform a task and situation specific risk assessment (eg: clean up the interior of the box you are working in).
4A	DC battery systems/equipment, various configurations (open rack, closed rack/enclosure, various voltage levels, various battery types), tasks may include cell or multiple cell "can" voltage testing, installing or removing cells/cans, torquing or maintenance or manipulation of connections, cleaning, inspecting, removing of covers or shielding/guards, etc.	Normal	Yes	Arc Flash Shock	Arc Flash PPE as determined by incident energy level. Shock PPE, tools & Equipment as required when inside Restricted Approach Boundary.	Yes, for repair or alteration, but see notes for when an EEWP is not required.	No	Yes, for repair or alteration or modification, and/or at QEW discretion	Some work tasks such as voltage testing or visual inspections would not require an EEWP since there are no modifications involved. In addition, special work procedures or equipment designs (such as splitter switches) which can allow for breaking down the battery bank to voltages below the arc flash cutoff (<100 VDC) and shock cutoffs (<50 VDC US, <60 VDC Canada) can eliminate shock and arc flash exposures so that an EEWP is not needed, and/or arc flash and shock PPE are not required. These assessments will also depend upon the nature of the work task and the specific equipment being worked on. Removal of insulated covers is not considered to be a "repair or alteration" for the purposes of triggering an EEWP (as long as there is no conductive hardware or pieces that need to be manipulated in the process of removing the covers). To avoid short circuits, always use insulated hand tools and instruments and use extreme care when manipulating connections and cabling. Consider covering batteries with insulating blankets when manipulating, handling, or transporting to reduce the risk of inadvertent short circuits. Where chemical hazards also exist (eg: acid), ensure proper risk controls in place to mitigate these hazards. Refer to SDS and battery manufacturer's information. Chemical/arc flash dual rate PPE is available on the market. Some areas use specialty battery maintenance contractors - they will follow work procedures to minimize voltage and arc flash exposures when working in battery systems (special sequencing of battery work for example). It is recommended that this information be included in job plans or other documents to facilitate safe work on battery systems. An EEWP is always a measure of last resort.
5A	Pull-in and termination, or de-termination and pull-out, of cables into an energized LV MCC or switchgear or enclosure or panel, potential to cross the restricted approach boundary.	Normal	Yes	Arc Flash Shock	Arc Flash PPE as determined by incident energy level. Shock PPE, tools & Equipment as required when inside Restricted Approach Boundary.	Yes	No	Yes	Known incidents in the past. For HV equipment, we expect this task to be less common, perform a task specific risk assessment.
5B	Pull-in and termination, or de-termination and pull-out, of cables into an energized LV MCC or switchgear or enclosure or panel, no potential to cross the restricted approach boundary.	Normal	No	No No	Minimum Enbridge Std PPE ESP Level 0 Minimum Enbridge Std PPE ESP Level 0	No	No	No	For HV equipment, we expect this task to be less common, perform a task specific risk assessment.
5C	Examination and manipulation of LV cables in tray (no exposed connections in vicinity).	Normal	No	No No	Minimum Enbridge Std PPE ESP Level 0 Minimum Enbridge Std PPE ESP Level 0	No	No	No	For HV cables in tray, perform task specific risk assessment (this should be a rare task).
8D	Installing, or removing, de-energized conductors into, or out of, existing conduit, pullbox, junction box, or wireway with other energized conductors present in the conduit simultaneously (Low Voltage)	Normal	No	No No	Minimum Enbridge Std PPE ESP Level 0 Minimum Enbridge Std PPE ESP Level 0	No	No	No	May be tricky to determine exactly if existing energized conductors in the conduit or a specific "box" is "normal" if things are hidden. Assess equipment condition prior to work, determine if normal or abnormal, if abnormal then do a situation specific risk assessment and this task would no longer apply. For HV splice boxes or junction boxes, outside of the scope of this task - do a task specific risk assessment.



10.5 APPENDIX E – ENERGIZED ELECTRICAL WORK PERMIT



Energized Electrical Work Permit

**PART I: TO BE COMPLETED BY THE REQUESTER:**

Job / Work Order Number (AFE): \_\_\_\_\_

(1) Description of circuit/equipment/job location: \_\_\_\_\_

(2) Description of work to be done: \_\_\_\_\_

(3) Justification of why the circuit/equipment cannot be de-energized or the work deferred until the next scheduled outage:  
 \_\_\_\_\_  
 \_\_\_\_\_

Requester/Title: \_\_\_\_\_ Date: \_\_\_\_\_

**PART II: TO BE COMPLETED BY THE ELECTRICALLY QUALIFIED PERSONS DOING THE WORK:**

(1) Detailed job description procedure to be used in performing the above detailed work:  
 \_\_\_\_\_  
 \_\_\_\_\_

(2) Description of the Safe Work Practices to be employed: \_\_\_\_\_  
 \_\_\_\_\_

(3) Results of the Shock Risk Assessment:  
 a. Voltage to which personal will be exposed \_\_\_\_\_  
 b. Limited approach boundary: \_\_\_\_\_  
 c. Restricted approach boundary: \_\_\_\_\_  
 d. Necessary shock personal, and other protective equipment to safely perform the assigned task \_\_\_\_\_

(4) Results of the Arc Flash Risk Assessment: \_\_\_\_\_  
 a) Available incident energy at the working distance or Arc Flash PPE Category \_\_\_\_\_  
 b) Necessary arc flash personal and other protective equipment to safely perform the assigned task \_\_\_\_\_  
 c) Arc Flash Boundary \_\_\_\_\_

(5) Means employed to restrict the access of unqualified persons to the work area: \_\_\_\_\_  
 \_\_\_\_\_

(6) Evidence of completion of job briefing, including discussion of any job-related hazards: \_\_\_\_\_  
 \_\_\_\_\_

(7) Do you agree the above described work can be done safely? \_\_\_ Yes \_\_\_ No (if No, return to requester)

Qualified Electrical Worker: \_\_\_\_\_ Date: \_\_\_\_\_  
 Qualified Electrical Worker: \_\_\_\_\_ Date: \_\_\_\_\_

**PART III: APPROVAL(S) TO PERFORM THE WORK WHILE ELECTRICALLY ENERGIZED:**

People Leader/Operations Electrical Supervisor: \_\_\_\_\_ Date: \_\_\_\_\_  
 Project Manager (if applicable): \_\_\_\_\_ Date: \_\_\_\_\_

Execution Safe Work Permit # \_\_\_\_\_ Execution Start Time: \_\_\_\_\_  
 Execution End Time: \_\_\_\_\_

10.6 APPENDIX F – ENERGIZED ELECTRICAL WORK PERMIT PROCESS

Energized Electrical Work Permit Process

April 26, 2023

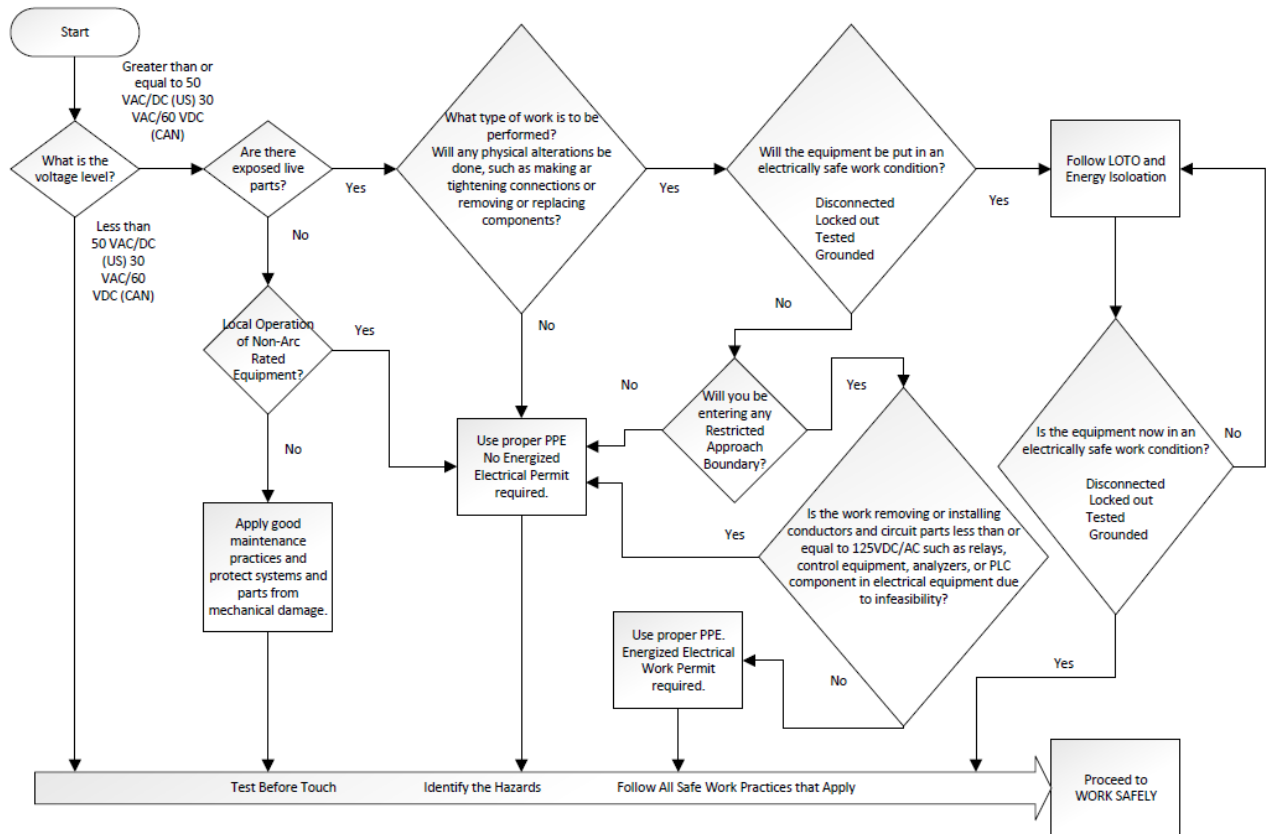





10.7 APPENDIX G – TEMPORARY POWER CERTIFICATE



Temporary Power Certificate (TPC)

Name of Requester:		Date (yyyy-mm-dd): ____/____/____	
Temporary Power Requirement Description:			
<b>Planning – System Operating Conditions:</b>			
Utility or Temporary Power Generation Transformer or Generator Rating: _____ kVA / _____ kW			
Voltage: _____ Volts		Rated Current: _____ Amps	_____ Phases
Other:			
<b>Planning – Operating Environment for Temporary Electrical Connection</b> check all the apply			
<input type="checkbox"/> Unclassified Area	<input type="checkbox"/> Hazardous Area	Class: _____	Division: _____ Zone: _____
<input type="checkbox"/> Wet	<input type="checkbox"/> Dry	<input type="checkbox"/> Indoor	<input type="checkbox"/> Outdoor
<input type="checkbox"/> Hot	<input type="checkbox"/> Cold	<input type="checkbox"/> Dusts	<input type="checkbox"/> Corrosive
<input type="checkbox"/> Requires Mechanical Protection?:			
<input type="checkbox"/> Other: Enter any other applicable conditions.			
<b>Specifications:</b> Document a summary of the electrical power distribution equipment that is required.			

Revision 1





**Temporary Power Certificate (TPC)**

Checklist for Safeguarding Protection and Controls Required:			
Requirement	Yes	No	Description of Control
Over Current Protection?	<input type="checkbox"/>	<input type="checkbox"/>	
Overload Protection?	<input type="checkbox"/>	<input type="checkbox"/>	
Temperature Protection?	<input type="checkbox"/>	<input type="checkbox"/>	
Electrical Grounding?	<input type="checkbox"/>	<input type="checkbox"/>	
Electrical Bonding?	<input type="checkbox"/>	<input type="checkbox"/>	
Single Line Diagrams (SLD) and other Drawings Attached?	<input type="checkbox"/>	<input type="checkbox"/>	
Main Breaker is Open and Locked out if Generator is used to back feed an MCC?	<input type="checkbox"/>	<input type="checkbox"/>	
Load / Source Tagged?	<input type="checkbox"/>	<input type="checkbox"/>	
Materials Suitable for Installation Environment (i.e. general purpose or hazardous locations, corrosive, min/max temperatures etc.)?	<input type="checkbox"/>	<input type="checkbox"/>	
Material Suitable for Service Conditions?	<input type="checkbox"/>	<input type="checkbox"/>	
Proper voltage setting on generator confirmed prior to energizing?	<input type="checkbox"/>	<input type="checkbox"/>	
Phase rotation of equipment confirmed to be same as generator output?	<input type="checkbox"/>	<input type="checkbox"/>	
CEC or NEC Wiring Method Applied?	<input type="checkbox"/>	<input type="checkbox"/>	
Hazardous Location Seals Identified?	<input type="checkbox"/>	<input type="checkbox"/>	
Mechanical Protection?	<input type="checkbox"/>	<input type="checkbox"/>	
Any Electrical Variances Approved by the Jurisdiction Having Authority?	<input type="checkbox"/>	<input type="checkbox"/>	
Inspection Required by the Jurisdiction Having Authority?	<input type="checkbox"/>	<input type="checkbox"/>	
Cables are Adequately Protected?	<input type="checkbox"/>	<input type="checkbox"/>	
Danger High Voltage Warning Signs Installed?	<input type="checkbox"/>	<input type="checkbox"/>	
Appropriate Flagging Installed for Cables?	<input type="checkbox"/>	<input type="checkbox"/>	
Quality Control and Execution:			
QEW Planning Approval Signature:	Installation Date:	Expiry Date:	
QEW Extension Approval Signature:	Extension Date:	Extension Expiry Date:	

Revision 1



**Temporary Power Certificate (TPC)**

Qualified Electrical Worker (QEW) has confirmed the following are correct as specified above and temporary power installation is installed with no visible damage.		
	Requirement	Check
i	Installed and inspected as per attached drawings and material specifications?	<input type="checkbox"/>
ii	Safeguarding controls installed as specified above?	<input type="checkbox"/>
iii	Perform function test?	<input type="checkbox"/>
iv	Complete visual electrical inspection?	<input type="checkbox"/>
<b>Sign-off:</b>		
<b>QEW - Installed and Approved for Energization:</b>		
Initials: _____ Date: (yyyy-mm-dd) ____/____/____ Time: _____ <input type="checkbox"/> AM <input type="checkbox"/> PM		
<b>Temporary Power System or Electrical Connection Permanently Removed:</b>		
QEW: _____ Date: (yyyy-mm-dd) ____/____/____ Time: _____ <input type="checkbox"/> AM <input type="checkbox"/> PM		

Revision 1



10.8 APPENDIX H – POWER UTILITY INFORMATION FORM



POWER UTILITY INTERCONNECTION INFORMATION

REGION: \_\_\_\_\_

STATION: \_\_\_\_\_

UTILITY COMPANY: \_\_\_\_\_

UTILITY COMPANY  
CONTACT NAME/NUMBER: \_\_\_\_\_

POWER LINE CIRCUIT IDENTIFIER: \_\_\_\_\_

POWER LINE CIRCUIT VOLTAGE: \_\_\_\_\_

ENBRIDGE OPERATOR-IN-CHARGE \* \_\_\_\_\_

ENBRIDGE OPERATOR-IN-CHARGE  
CONTACT INFORMATION: \_\_\_\_\_

- \*Operator-in-Charge:** An individual that:
- Is knowledgeable and experienced in the operation of high voltage substations who has been assigned the responsibility for the operation of the electrical system.
  - Has authority within their jurisdiction to approve or reject work performed on the electrical system
  - Is responsible for maintaining the requirements of the Interconnection Agreement if one is in place with other electrical systems.

## 10.9 APPENDIX I – ENBRIDGE ELECTRICAL SAFETY TOOLS & EQUIPMENT

Electrical tools and equipment provided by Enbridge must meet and/or be certified to all applicable standards for the task they are to be used for and be selected, stored, used and maintained in accordance with the requirements of this appendix.

### 10.9.1 TEMPORARY PROTECTIVE GROUNDS (TPGs)

Temporary protective ground cable conductors shall be rated for the potential fault current at the location being grounded and for the upstream clearing time. Different temporary protective ground cable ratings may be required for equipment in the electrical switchgear buildings (ESBs) and substations due to dissimilar fault levels and clearing times.

Preferred Manufacturers:

- Salisbury
- Hubbell-Chance
- CATU
- Pfisterer
- Hastings

#### Ground Cables

Ground cables are generally available in three different colored insulation jackets:

- *Yellow-jacketed cable* – generally indicates that it is serviceable for lower temperatures and, therefore, more suited for outdoor applications.
- *Black-jacketed cable* – generally indicates that it is serviceable for lower temperatures and, therefore, more suited for outdoor applications.
- *Transparent-jacketed cable* – generally indicates that its minimum serviceable temperature is somewhat higher than yellow- or black-jacketed cables and, therefore, is more suited to indoor applications in cold climates.

**Note:** *Although the above colors of insulation jackets and corresponding serviceable temperatures are most common, the color of insulation jacket and serviceable temperature may vary by manufacturer.*

Fabrication of temporary protective grounds shall only be by an approved vendor. Field fabrication of grounds is not permitted.

*Table 1: Temporary Protective Grounds, Ground Cables*

ASTM F855 TYPE	DESCRIPTION
I	Cables shall have stranded soft drawn copper conductor with stranding of 665 wires or more #30 AWG or #34 AWG wire, and elastomer jacket rated by the manufacturer, flexible for installation and serviceable for continuous use at temperatures ranging from -40°C (-40°F) through 90°C (194°F).
II	Cables shall have stranded soft drawn copper conductor with stranding of 133 wires or more #2 AWG or 259 wires or more for size 1/0 and larger and elastomer jacket rated by the manufacturer, flexible for installation and serviceable for continuous use at temperatures ranging from -25°C (-13°F) to 90°C (194°F).

ASTM F855 TYPE	DESCRIPTION
III	Cables shall have stranded soft drawn copper conductor with stranding of 665 wires or more #30 AWG and thermoplastic jacket rated by the manufacturer, flexible for installation and serviceable for continuous use at temperatures ranging from -10°C (14°F) to 60°C (140°F).

### Specifications

Temporary protective grounds shall meet or exceed one of the requirements set out in:

- ASTM F855
- CAN/ULC D61230
- IEEE Std. 1246

It is recommended, but not required, that yellow jacketed cable be used since it is flexible and the most durable and suitable for indoor and outdoor applications.

The required ASTM F855 Type cable should be referenced (i.e., Type I, II or III).

Only copper conductors shall be specified for temporary protective ground cables.

A unique identification tag shall be assigned to each set of temporary protective ground cables. This will be indicated on the storage case or bag and on the cable with a non-conductive tag.

The conductor size, current carrying capacity and assumed clearing time should be permanently marked on each set of temporary protective ground cables with a non-conductive tag.

Temporary protective grounding equipment must be capable of conducting the maximum short circuit current that could flow at the point of grounding for the time necessary to clear the fault. Contact Operations Engineering for sizing information and validation.

### Assembly Type

Temporary protective grounds (i.e., ground sets or clusters) should be specified for the intended application (i.e., grounding three switchgear phases to a ground bus, overhead line grounding, etc.). For example, a flat bus bar connection would require a four-way connector set with flat-face grounding clamps.

The assembled temporary protective grounds can be designated based on a classification of design types (Design I to V), as outlined in ASTM F855.

**NOTE:** Minimum #2 AWG conductors shall be used. Splicing of conductors is not permitted. Paralleling of temporary protective grounds is allowed if required to meet the available fault current requirements, but consideration of unequal current division between parallel grounds shall be considered and derating factors applied: for two parallel cables, multiply by 1.8; for three parallel cables, multiply by 2.6.

### Cable Lengths

The length of both the ground cable and phase cable conductors should be kept to a minimum length to reduce voltage drop and eliminate the risk of cable whipping if energized.

For outdoor substation work there may be no choice but to increase protective ground cable conductor lengths to attach the conductors to the points to be grounded.

Excess cable length should be coiled and tied off (i.e., using hemp rope or plastic tie-wraps) to eliminate risk of cable whipping if energized.

### Clamps

Clamps shall be specified for the maximum fault current carrying capacity and possible clearing time of the upstream disconnecting device (e.g., circuit breaker or fuse).

Clamps shall be suited to the conductor they will be connected to and should be specific to the electrical equipment (e.g., bare overhead conductors, bus bar and ground ball connections).

A Type III tee handle clamp may be provided on the grounding conductor and may be provided for the phase conductors if there is inadequate access to the electrical equipment to use a Type I or II clamp with an associated hot stick.

Clamp main contact jaws should be specified with Class A, smooth or Class B, serrated.

The preferred method of application of temporary protective grounds is with the use of a suitable hot stick.

*Table 2: Temporary Protective Grounds, Clamp Types*

CLAMP TYPE	DESCRIPTION
I	Clamps for installation on de-energized conductors equipped with eyes for installation with removable hot sticks.
II	Clamps for installation on de-energized conductors having permanently mounted hot sticks.
III	Clamps for installation on permanently grounded conductors or metal structures with tee handles, and eyes or square or hexagon head screws, or both.

### Ferrules

Only threaded stud compression ferrules shall be specified on new temporary protective grounds. The specific type of ferrule as per ASTM F885 (e.g., Type I, III IV, V or VI) shall be specified at order.

### Storage

A protective storage case or bag is recommended.

### Pre-Use Inspection

The Qualified Electrical Worker shall check the integrity of the temporary protective grounds before every use. All components of the temporary protective grounds shall be inspected including clamps, ferrules, conductor insulation and star point connection, if applicable, for damage and contamination. Specifically check for:

- cracked or broken ferrules and clamps
- exposed broken strands
- cut or badly crushed or flattened cables
- extensively damaged or contaminated (e.g., oily) cable jacket material
- swollen cable jacket or soft spots, indicating internal corrosion
- cable strands with black deposit on them

If the temporary protective grounds are damaged or experience a fault, they shall be tagged as 'Damaged' and placed out of service and sent in for repair and testing or discarded.

### Testing Requirements and Frequency

As a minimum, temporary protective grounds shall be tested prior to use and, subsequently, at a frequency as outlined in the applicable ASTM or IEEE standards. Manufacturer's test and care requirements shall be followed if they exceed that required by the ASTM or IEEE standards. Temporary protective grounds shall be tested every 3 years by an approved high voltage testing laboratory or internally in accordance with the applicable standards.

At the discretion of the responsible People Leader and using an approved tester such as Hubbell-Chance Protective Grounding Set Tester or equal (any such tester shall meet the requirements of ASTM F2249), a company Qualified Electrical Worker can provide the required testing of the temporary protective grounds. Records of the test date, results and initials of the individual that completed the test shall be maintained. A sticker containing the results of the test shall be applied to the temporary protective grounds after each test.

**Note:** Connection locations for temporary protective grounds may be indicated on the single line diagram. Check the single line diagrams to confirm.

## **10.9.2 HIGH VOLTAGE DETECTORS AND TESTERS**

All high voltage and current testers shall be rated for the circuits and equipment for which they are used.

To avoid possible electric or personal injury, do not use a voltage or current meter on circuits that exceed their rated capacities.

When completing voltage tests for absence of voltage, use one of the detectors and testers indicated in Table 11.

*Table 3: Required Voltage Detectors*

<b>MANUFACTURER AND TYPE</b>	<b>COMMENTS</b>
Salisbury Catalog #4556, Model 4544 Voltage Detector, Self-testing Audio and Visual, Off-240V-4.2kV-15kV-25kV-35kV-69kV-115kV-230kV, Proximity type, includes case and hot stick adapter	Model 4544 Voltage Tester is included with this kit
Chance Catalog #C403-2794, Digital Voltage Indicator, 1-40kV, Direct Contact type	Ensure protective case is ordered

### Specification

Ensure the voltage detector or tester is designed to meet or exceed the system voltage that is to be tested. The voltage detector shall meet or exceed the applicable requirements set out in ASTM F1796 or CAN/ULC D61243.

Voltage detectors should be equipped with a convenient pre-use test or procedure to ensure it is in good working order before testing for the absence of system voltage.

The voltage detector should be suitable for indoor and outdoor applications and operational in ambient temperatures of -24°C (11.2°F) to 70°C (158°F).

### Marking

The voltage detector or tester shall be marked with an approved certification mark.

A unique identification tag should be assigned to each voltage detector or tester. This will be indicated on the detector (if possible) and/or its storage case with a non-conductive tag.

### Storage

The voltage detector or tester shall be stored in a suitable hard case, located in a clean and dry central location at normal room temperature.

### Pre-Use Inspection and Test

Before every use, the voltage detector or tester shall be visually inspected for any damage, including cracks, broken connection points (e.g., for hot stick attachment etc.), and shall not be used if damaged.

An operational integrity check shall be completed before every use in accordance with the manufacturer's operating instructions. The self-test feature shall be used before and after each use.

**NOTE:** To test a proximity type voltage detector, one option is to set it to its lowest voltage position (e.g., 240 V/Test position) and locate the detector head close to, but not in contact with, a known voltage source such as a 120/240 VAC circuit (e.g., a lighting panel) and the detector should sense and indicate the presence of voltage. The use of a 'Voltage Tester' (i.e., Salisbury) that creates a low energy high voltage field that can be used for testing high voltage proximity testers and is recommended.

A fluorescent light fixture ballast is not an acceptable voltage source for a test.

If the voltage detector is equipped with a selector switch for various voltage settings, ensure it is set at the system voltage being tested.

### Testing Requirements and Frequency

Detectors should be tested in accordance with manufacturer specifications.

**Note:** The Company has consulted detector manufacturers, and, in all cases, the manufacturers have confirmed the detectors are designed to operate without the need of calibration.

## **10.9.3 LOW VOLTAGE DIGITAL MULTI-METERS AND MISCELLANEOUS ELECTRICAL METERS**

Digital multi-meters and miscellaneous electrical meters that will be used when working on company electrical equipment shall meet the following requirements.

Preferred Manufacturers:

- Fluke (preferred)
- Ideal
- AMEC
- Amprobe

**Note:** If uncertain that an unlisted manufacturer is approved, contact your People Leader.

### Specification

The minimum specification requirements for digital multi-meters and miscellaneous electrical meters are:



- CAN/CSA 22.2 No.61010-031
- UL 61010-031
- UL 1244

When purchasing digital multi-meters, ensure that the equipment satisfies these standards and it is suitably marked with a recognized and approved body's inscription on the product suitable for use in Canada or the United States as required.

All digital multi-meters and miscellaneous electrical meters used at facilities by qualified electrical workers shall be minimum Cat IV, 600V.

A unique identification tag should be assigned to each voltage detector. This shall be indicated on the detector (if possible) and/or its storage case with a non-conductive tag.

### Transient Overvoltage Categories I to IV

Table 4: Transient Overvoltage Categories I to IV

OVERVOLTAGE CATEGORY	BRIEF DESCRIPTION	EXAMPLES
CAT IV	Three phases at utility connection, any outdoor conductors	<ul style="list-style-type: none"> <li>• Refers to the origin of the installation (i.e., where low-voltage connection is made to utility power)</li> <li>• Electric meters, primary overcurrent protective equipment</li> <li>• Outside and service entrance, service drop from pole to building, run between meter and panel</li> <li>• Overhead line to detached building, underground line to well pump</li> </ul>
CAT III	Three phases at distribution including single-phase commercial lighting	<ul style="list-style-type: none"> <li>• Equipment in fixed installations, such as switchgear (SWGR) and polyphase motors</li> <li>• Bus and feeder in industrial plants</li> <li>• Feeders and short branch circuits, distribution panel devices</li> <li>• Lighting systems in large buildings</li> <li>• Appliance outlets with short connections to service entrance</li> </ul>
CAT II	Single-phase receptacle connected loads	<ul style="list-style-type: none"> <li>• Appliance, portable tools, and other household similar loads</li> <li>• Outlet and long branch circuits</li> </ul>
CAT I	Electronics	<ul style="list-style-type: none"> <li>• Protected electronic equipment</li> <li>• Equipment connected to (source) circuits in which measures are taken to limit transient overvoltages to an appropriate low level</li> <li>• Any high voltage, low energy source derived from a high winding resistance transformer such as the high voltage section of a copier</li> </ul>

### Fusing

Internal fusing on all digital meters and miscellaneous electrical meters shall be replaced with like for like fuses. When replacing the fuse, ensure it is approved to manufacturer's specifications and it is a high energy fuse.

### Leads and Other Accessories

Ensure that leads and other accessories are the same transient overvoltage category as the meter. Check the leads and accessories to ensure they are marked with the category and an approved mark.

The use of fused leads is not a mandatory requirement.

### Storage

The digital meter or miscellaneous electrical meter shall be purchased with a protective case.

### Pre-Use Inspection

Before using digital meters, the user should complete the following pre-use inspection:

- visually inspect the equipment and associated test leads or accessories, cables, power cords, probes and connectors for external defects and damage – if a defect is found, the item should be removed from service until it can be repaired or replaced,
- look and verify that the equipment, leads and any accessories are labeled with an approved mark, and
- look and verify that the equipment, leads and any accessories are labeled with overvoltage transient category. Test leads and accessories should meet or exceed the overvoltage transient category of the equipment.

### Testing Requirements and Frequency

Meters should be tested in accordance with manufacturer specifications.

*NOTE: The Company has consulted detector manufacturers, and, in all cases, the manufacturers have confirmed the detectors are designed to operate without the need of calibration.*

## **10.9.4 HOT STICKS (LIVE-LINE TOOLS)**

Preferred Manufacturers:

- Salisbury
- Hubbell-Chance
- Hastings
- Pfisterer
- CATU

### Application

Approved hot sticks (live-line tools) are required to be used, when possible, when applying temporary protective grounds, when testing for the absence of voltage and miscellaneous substation overhead work. Hot sticks are available that are unique to the equipment that they will be used with. Ensure that when procuring hot sticks, consideration is given to the intended application.

Specific consideration shall be given to the length of the hot stick. It is important to ensure that the hot stick is not too short or too long. A minimum length will be required in some instances to maintain the required safe limit of approach distances for overhead power lines as specified in applicable Occupational Health and Safety codes.

### Specification

The hot stick shall meet or exceed the applicable requirements set out in ASTM F711 and IEEE Std. 978. Ensure that the hot stick is inscribed with an approved mark and the manufacturer's information including serial number and date of manufacture.

### Style and Type

Hot sticks shall be rated and suitable for the intended specific work task (e.g., testing for absence of voltage, application of temporary protective grounds, overhead line work, etc.)

### Storage

The hot stick shall have a suitable storage container, either a vinyl or canvas bag/case or storage tube. Where the hot stick is used in a substation application, it can be stored in a suitable PVC container mounted on the substation fence.

### Pre-Use Inspection

Ensure the hot stick is not contaminated with dirt, oil, and other conductive materials.

Clean the hot stick in accordance with manufacturer specifications.

Check the mechanical function of the hot stick prior to every use to ensure that it works properly (e.g., grip, shotgun hot stick hooking mechanism).

## **10.9.5 STATIC DISCHARGE STICK**

At the discretion of the responsible People Leader, a static discharge stick can be provided. If a static discharge stick is provided it shall meet the requirements set out in this subject.

Preferred Manufacturers:

- Salisbury
- Hubbell-Chance
- Hastings
- CATU

---

### Specification

#### ASTM F711

Ensure that the static discharge stick is inscribed with an approved mark and the manufacturer's information, including serial number and date of manufacture.

Ensure the grounding clamp is suitable for the anticipated ground connection point and the cable is connected to the clamp with a strain relief device.

### Storage

The static discharge stick shall be stored in a clean environment, stored in a suitable locker, case, or attached to a wall.

### Pre-Use Inspection

Ensure the static discharge stick and its components are not damaged or contaminated with dirt, oil, and other conductive materials.

Clean the static discharge stick as per manufacturer's specifications.

## **10.9.6 INSULATED HAND TOOLS**

### Specifications

- ASTM F1505
- 29CFR1910.335

### Storage

Insulated hand tools should be purchased with a suitable storage wrap or case. Insulated hand tools shall be stored separately from non-insulated hand tools and shall only be used for energized electrical work. The wrap or case should be marked on the outside 'insulated hand tools, 1000V'.

### Pre-Use Inspection

Before every use, the insulated hand tools shall be checked for any damage to the insulation that would negatively impact the integrity of the tool. If the outer orange insulation is compromised and the inner yellow insulation can be seen, the tool shall be discarded.

### Testing Requirements and Frequency

There are no requirements for in-service testing of insulated hand tools. Original Manufacturer's testing as per ASTM F1505 is the only requirement.

## **10.9.7 RECORDS**

### Tool and Equipment Test Records

Retain tool and equipment test records that include the test date, results, and tester initials, onsite until next test is conducted.

## 10.10 APPENDIX J – ENERGIZED ELECTRICAL SAFE WORK PRACTICES

The following preventive and protective control measures are performed to protect personnel from electrical hazards. There are two categories of Safe Work Tasks: General and Substation.

### ***10.10.1 GENERAL SUBSTATION-RELATED SAFE WORK TASKS***

- Make sure that you can be seen when around vehicles. Do not stand under lifted loads, buckets, etc.
- Ensure portable equipment and vehicles are properly bonded and grounded as required.
- Be aware of the risk of injury or damage to health from the mechanical components of switching & isolation devices.
- Ensure the bonding of metal grating and operating switches is intact before touching or operating the switch.
- Electrical Specific PPE, Tools & Equipment used in energized high voltage substations shall be made of non-conductive material selected, inspected, and approved for the work task.
- Do NOT use metal ladders, wooden ladders, metal measuring tapes, ropes, hand lines, metal hard hats or similar equipment constructed of metal, or with metal strands in the fabric. This equipment is PROHIBITED from entering the Substation.
- Never carry anything over your shoulders.
- Ask for help if you have to carry something that is awkward.
- Do not rush. Plan every move and only work according to the plan and written procedure.
- Arms are to be kept below shoulder level when working around energized substation equipment.
- Look up and check the equipment before you start to work around it. Check for broken risers, broken porcelain or anything that is in an abnormal condition.

## 10.11 APPENDIX K – ELECTRICAL HAZARD FOR DC SYSTEMS AND REMOTE VALVE SITES

### 1. Electrical Hazard for DC Systems

DC Systems	Nominal System Voltage (VDC)	Incident Energy at 455mm (18in) Working Distance	Arc-flash Boundary
UPS (up to 10 kVA)	$100\text{ V} \leq \text{VDC} \leq 250\text{ V}$	8 cal/cm <sup>2</sup>	1.2 m (4 ft)
UPS (up to 15 kVA)	$100\text{ V} \leq \text{VDC} \leq 250\text{ V}$	12 cal/cm <sup>2</sup>	1.5 m (5 ft)
Battery-Only (no UPS) (up to 400 Ah)	$100\text{ V} \leq \text{VDC} \leq 250\text{ V}$	8 cal/cm <sup>2</sup>	1.2 m (4 ft)

DC Systems	Shock Hazard (VDC)	Glove Class	Limited Approach	Restricted Approach
Batteries/UPS	$50\text{ V} < \text{VDC} \leq 250\text{ V}$	00	1 m (42 in)	Avoid contact

### 2. Electrical Hazard for Remote Valve Sites

Remote Valve Site	Nominal System Voltage (VAC)	Arc Flash PPE Category	Arc-flash Boundary
Service Disconnect	$\leq 480\text{ V}$	4	6 m (20 ft)
Equipment Protected by the Service Disconnect	$\leq 480\text{ V}$	2	1.5 m (5 ft)

Remote Valve Site	Shock Hazard (VAC)	Glove Class	Limited Approach	Restricted Approach
All 480 V Circuits	$\leq 480\text{ V}$	00	1 m (42 in)	0.3 m (12 in)

### 3. Other PPE Considerations

- 3.1. For  $\geq 100\text{ VDC}$  installations that fall outside of the previous tables contact Operations Engineering to assess the hazard;
- 3.2. In addition to the shock hazard and the arc flash hazard, DC battery systems may pose additional hazards, such as chemical hazards and explosion hazards;
- 3.3. The additional hazards and risks may depend on the battery construction (flooded cell, valve-regulated, gel type, etc.) and are not covered in this standard.
- 3.4. For existing remote valves with labels (only in Canada), the incident energy on the label is to be used until the label is removed.

## 11.0 CHANGE LOG

Section	Version 5.0
Throughout	<p>Scope section wording clarified.</p> <p>Related documents updated to reflect both LP and corresponding GTM documents.</p> <p>Definitions and acronyms corrected/updated and new terms added to support revisions in this version.</p> <p>Roles and responsibilities updated to cover both LP and GTM BU's.</p> <p>Normal and Abnormal Electrical Installations expanded to provide guidance on abnormal electrical equipment risk mitigations.</p> <p>Worker Qualifications includes additional trades plus Electrical Safety Watch role/qualifications/engagement added. Referenced Appendix A Electrical Work Tasks by Qualification table revised and clarified, QOW role authorized tasks revised (related to HV switching and racking tasks).</p> <p>Establishing an Electrically Safe Work Condition revised to align with NFPA 70E and CSA Z462.</p> <p>Energized electrical work definition clarified. Switching of electrical equipment in NORMAL condition not considered to be energized electrical work, and therefore arc flash and shock PPE not required.</p> <p>Flowsheet updated for Energized Electrical Work Permit (Appendix F),</p> <p>Arc Flash and Shock Hazard Risk Assessment updated to reflect new risk register. Original risk register summary columns replaced with new risk register summary columns in Appendix D.</p> <p>Guidance given on what to do if available arc flash PPE ATPV rating is less than the exposure.</p> <p>Electrical Work Zones section revised to also cover electrical equipment areas and electrical facility access restrictions for unauthorized workers.</p> <p>Electrical PPE sections updated with new PPE poster plus additional requirements/clarifications.</p> <p>Appendix I (was formerly Appendix J) electrical PPE reference tables formatting and layout corrected.</p> <p>Energized Electrical Safe Work Practices moved to a new Appendix J.</p> <p>High Voltage Substations revised to include additional pre-job planning for substation work activities. Main text and Appendix C revised to use new Electrical Switching and Work Clearance Form (replaces original Energized Electrical Equipment Isolation and Work Clearance form). HV substation safe work practices moved to a new Appendix J.</p> <p>Post Fault Re-Energization Procedure section now also covers Post Service Equipment Re-Energization -content added to align with NFPA 70E and CSA Z462.</p> <p>Electrical Incidents and Reporting – Updated to reflect current processes. “Incidents” now referred to as “Events” throughout, unless referring to specific document titles or phrases related to incident energy.</p> <p>Electrical Emergency Response updated. Rescue tethers now mentioned.</p>



---

# Standard

---

## Emergency Preparedness – Personal Safety

---

**Effective Date:** 2019-03-30

**Version #:** 1.5

**Version Date:** 2024-03-27

---





This page intentionally left blank

**EMERGENCY PREPAREDNESS – PERSONAL SAFETY STANDARD**

Version #: 1.5  
Version Date: 2024-03-27



**Document Version Register**

Version Number	Version Date	Approved By	Section Number and Title	Details of Version
1.0	2019-03-30	Sean Evans	Whole Document (New Standard)	This is the new H&S standard that was developed as part of the LP   MP Safety Manual Transition Project
1.1	2019-10-31	Sean Evans	6.1, 6.3, 6.5	Updated
1.2	2020-06-01	Sean Evans	2.0	Alignment with Contractor Safety Specifications
1.3	2021-12-01	Murray Evenson	6.6, 9.0	Minor changes to fire extinguisher requirements and updated section 9 to reflect the appropriate review process
1.4	2023-04-18	Murray Evenson	11.1	Update to SCBA requirements in table
1.5	2024-03-27	Troy Croft	All sections	Clerical corrections

**EMERGENCY PREPAREDNESS – PERSONAL SAFETY  
STANDARD**

Version #: 1.5  
Version Date: 2024-03-27



---

This page intentionally left blank

---

## Table of Contents

1.0	Purpose .....	3
2.0	Scope .....	3
3.0	Prerequisites.....	3
4.0	Definitions & Acronyms .....	3
5.0	Roles & Responsibilities.....	3
6.0	Standard – Specific Requirements.....	4
6.1	First Aid.....	4
6.2	First Aid Equipment .....	4
6.3	Eyewash Stations .....	5
6.4	Automated External Defibrillator.....	6
6.5	Portable Fire Extinguishers .....	7
6.6	Fire Prevention and Protection .....	9
6.7	Windssocks .....	11
6.8	Boats.....	11
6.9	Vehicles .....	11
6.10	Medical Plan .....	11
6.11	Emergency Procedures and Evacuation Plan.....	11
6.12	Inspections.....	12
7.0	Training Requirements .....	12
8.0	Related Documents .....	12
9.0	Standard Review .....	12
10.0	References .....	12
11.0	Appendix.....	13
11.1	Summary of Required Safety Equipment at Enbridge Regional Locations.....	13
11.2	Boat Safety Equipment Requirements – CAN.....	14



---

11.3 Boat Safety Equipment Requirements – USA.....	16
11.4 Summary of Safety Equipment Requirements for Enbridge Vehicles.....	16
11.5 Inspection Frequency for Fire Suppression Equipment .....	18
11.6 Maintenance Frequency for Portable Fire Extinguishers .....	19
11.7 Hydrostatic Test Frequency for Cartridges and Cylinders .....	20
11.8 Stock Amounts—Fire Extinguisher Supplies.....	20
Change Log.....	21

## **1.0 PURPOSE**

The purpose of this Standard is to ensure that Enbridge locations are prepared to provide adequate and timely medical and emergency response at all company vehicles, facilities and locations.

## **2.0 SCOPE**

This standard applies to LP Operations and to projects being completed for LP.

Contractors and subcontractors shall comply with Enbridge health and safety requirements set out in this standard, as articulated within applicable contractor safety specifications. If a contractor or subcontractor has a health and safety standard or policy materially different from Enbridge's, the contractor/subcontractor shall follow the most stringent requirement. Contractors and subcontractors are still obligated to meet the requirements of all applicable laws related to this standard.

In the event a contractor's or subcontractor's standard exceeds the requirements of this standard, Enbridge may, in its sole discretion, choose to adopt the contractor's or subcontractor's standard for any given contract or work order.

The Emergency Management Program is out of scope for this Standard.

## **3.0 PREREQUISITES**

Bloodborne Pathogens Exposure Control Standard

Hot Work & Ignition Sources Standard

Inspection Standard

Storage and Transportation of Hazardous Materials Standard

## **4.0 DEFINITIONS & ACRONYMS**

*AED* – Automated External Defibrillator. A device that, once activated, automatically performs an analysis of the heart rhythm and, if it detects a problem that may respond to an electrical shock, permits a shock to be delivered to restore normal heart rhythm.

*NGL* – Natural Gas Liquids

*PFD* – Personal Flotation Device

*PLM* – Pipeline Maintenance

*ROW* – Right of Way

## **5.0 ROLES & RESPONSIBILITIES**

People Leaders shall:

- Provide sufficient resources to effectively implement this Standard; and

- Ensure applicable inspections are completed and corrective actions are implemented on a timely basis.

Workers shall:

- Immediately address deficiencies related to emergency preparedness requirements detailed within this Standard;
- Notify their People Leader immediately of found deficiencies that cannot be addressed by the employee; and
- Perform inspections as required.

Safety Team shall:

- Provide timely advice, support and assistance to People Leaders and employees in the implementation of this Standard; and
- Perform inspections when designated.

Safety Shared Services shall:

- Be responsible for the maintenance and continuous improvement of this Standard.

## **6.0 STANDARD – SPECIFIC REQUIREMENTS**

For a complete listing of personal safety emergency response equipment requirements for all Enbridge locations and motorized equipment please reference the Appendix of this Standard.

### **6.1 FIRST AID**

The number of first aiders at an Enbridge Location and their level of training shall be established according to local Applicable Legislation.

The requirements for medical staff and their level of qualification shall be established according to Applicable Legislation. Kits shall also include contents referenced in the Bloodborne Pathogens Exposure Control Standard.

If a Worker is injured or wounded (e.g., cut, scrape, open wound) during water washing operations (e.g., when operating or working near a water lance), seek medical attention. Such wounds have a high risk of infection.

Wounds caused by a water lance should be treated in the same way as other wounds, except for the following steps:

- After bleeding has stopped, pour bottled or clean running water over the wound; and
- If possible, leave unclean wounds open until they have been assessed by a medical professional.

### **6.2 FIRST AID EQUIPMENT**

All Enbridge Locations and vehicles shall be equipped with first aid kits in compliance with applicable legislation.

Identification of each first aid kit shall include the words 'FIRST AID' or the first aid symbol.

For Enbridge vehicles, first aid kits shall be:

- Secured in an accessible location; and
- Inspected monthly and re-stocked, as necessary.

For facilities and project locations, first aid kits shall be:

- Installed in conspicuous location that is accessible at all times to all Workers; and
- Inspected monthly and re-stocked, as necessary.

Posted notices shall identify the location of first aid kits. Notices shall be easily visible and posted at practical locations where Workers and Visitors will see the notice, such as:

- At building entrances;
- In and around the building or Site, e.g., in elevators, on notice boards, etc.; and
- On each Site Safety Plot Plan and/or Emergency Evacuation Plan.

At unattended sites or locations where Workers are not regularly present, place the first aid notices on the outside of the building, including a statement that first aid supplies are available inside and clearly noting the storage location.

A first aid manual and list of required first aid supplies shall be included inside each first aid kit.

*Note that some equipment within a First Aid kit will have an expiration date.*

### **6.3 EYEWASH STATIONS**

If a worker may be exposed to chemicals that are harmful to the eyes, there must be immediate access to emergency equipment (i.e. showers, eye wash stations etc.) appropriate for the potential level of exposure.

Enbridge Locations shall have eyewash stations available in work environments where workers may be exposed to chemical Hazards and meet the following requirements:

- Locate an eyewash station within 16.7 m (55 ft) or 10 seconds of harmful chemicals (e.g., strong acids or caustics) or where the Hazard Assessment determines eyewash station is required.
- All types of eyewash stations shall be clearly identified and readily accessible. Do not block access; areas around the station shall be kept clear.
- Supply tepid (lukewarm) potable water for fixed plumbed systems. Placement of portable systems should consider the availability of access to potable water.



- Inspect plumbed, self-contained and portable eyewash equipment monthly. All models shall have approved nozzle caps (to prevent foreign matter buildup) and be cleaned and mounted correctly.
- For self-contained eyewash stations and unsealed portable eyewashes, change the flushing fluids quarterly, or as specified by the manufacturer. If using water, add a preservative to maintain freshness; there are commercial additives that can help prevent freezing and micro-organism build-up.
- Locate squeeze bottles close to the chemical Hazard and protect each bottle from the elements (e.g., prevent freezing).
- During inspection, ensure the eyewash equipment is clean; placed in its designated location. Also ensure sufficient eyewash fluid is available. When inspecting portable eyewashes, ensure the seal is not broken or past the expiry date. If expired, replace immediately or at the earliest possible date.
- Fixed eyewash stations may be plumbed into the potable water system or have a reservoir. In addition:
  - fixed eyewash stations should be mounted so the discharge nozzles are between 83.8 and 134.6 cm (33 to 53 inches) off the ground;
  - remote fixed eyewash stations that do not have a constant potable water supply shall also have an emergency eyewash station capable of providing approximately 15 minutes of continuous flushing; and
  - During each inspection of a fixed eyewash station, flush the line and verify proper operation.

#### **6.4 AUTOMATED EXTERNAL DEFIBRILLATOR**

At permanent Enbridge office locations where emergency medical response times are more than 4 minutes, an AED shall be kept with the First Aid Kit as part of the standard first aid supplies.

Project, Regional or Departmental EH&S committees may consider placement of an AED at additional sites or locations, in cases where:

- The site or location has 6 or more employees; and/or
- The emergency medical response time for that location is greater than 20 minutes; and/or
- The project safety plan determines the need.

Additional AED requirements include:

- If a project is legally required to have a first aid room, an AED shall be kept in the room;

- Each AED shall be mounted on a wall or stored in a cabinet with proper signage and protective casing;
- Only Workers trained in the use of an AED are authorized to use an AED;
- AEDs are not intrinsically safe and shall not be stored in Hazardous Areas; and
- Inspect AEDs in accordance with manufacturer's specifications.

Before purchasing an AED model, please contact the Safety Team to confirm approved AED models for purchase.

For additional first aid and medical equipment requirements at Enbridge locations reference the Appendix of this Standard.

## **6.5 PORTABLE FIRE EXTINGUISHERS**

The minimum requirement for fire extinguisher placement is as follows:

- 2 – 20 lb. Dry Chemical Type for any work done in Hazardous or Restricted Areas;
- 1 – 20 lb. Dry Chemical Type for each work area within fenced locations;
- 1 – 20 lb. Dry Chemical Type for each office and storage trailer;
- 1 – 20 lb. Dry Chemical Type for each designated outdoor smoking area;
- 1 – 20 lb. Dry Chemical Type for each piece of Powered Mobile Equipment;
- 1 – 5 lb. Dry Chemical Type for ATVs and UTVs;
- 1 - 20 lb. fire extinguisher is mandatory within 22 m (75 ft) of any work activity; including ROW restoration projects.

In the event that a 20 lb fire extinguisher cannot reasonably be attached to smaller sized powered mobile equipment (for example Enbridge owned/leased riding lawn mowers or subcompact utility tractors) a 10 lb or 5 lb fire extinguisher can be utilized provided that:

- Other preventative measures are in place if required [for example: equipment is being used within the confines of an Enbridge Terminal/Station providing immediate access (within 30 meters or 100 feet) to additional 30 lb ABC fire extinguishers, additional fire prevention measures implemented due to dry conditions on right-of-way)]; and
- Regulatory requirements or manufacturer's specifications do not prescribe a larger fire extinguisher to be located on the specific equipment.

For Enbridge vehicle requirements see the Appendix of this Standard.

Each portable fire extinguisher shall cover no more than 230 m<sup>2</sup> (2500 ft<sup>2</sup>). Unless specific instructions indicate otherwise, position portable fire extinguishers so that travel distance to the extinguisher from the working area is:

- ≤ 23 m (75 ft) for Class A fires (e.g., wood, paper);
- ≤ 15 m (50 ft) for Class B fires (flammable/ combustible liquids);
- ≤ 23 m (75 ft) for Class D fires (metals such as sodium, magnesium, titanium).

Distances for Class C fires (electrical) are based on the surrounding fire hazards (Class A or Class B). Portable fire extinguishers for Class D hazards are required in work areas where combustible metal powders, flakes, shavings, or similarly sized products are generated at least once every two weeks.

Portable fire extinguishers shall be:

- Stored above the floor or ground (hand-held models), to prevent condensation and subsequent corrosion on extinguisher bases;
- Mounted in accordance with manufacturer's specifications when stored on vehicles or equipment, or where otherwise subjected to shock and vibration; and
- Covered for protection when placed outdoors permanently.

Regional and/or Project Offices shall have placement of fire extinguishing equipment based on applicable legislation, and at a minimum:

- One 10 lb to 20 lb dry chemical extinguisher inside each entrance door, rated according to the hazards in the building;
- One 20 lb CO<sub>2</sub> extinguisher outside the entry to any room housing electronics (e.g., computer server room, uninterruptible power supply (UPS) room, measurement room); and
- One 10 lb to 20 lb dry chemical extinguisher in the boiler room, rated according to the hazards in the room.

Pump Stations and compressor buildings shall have:

- Minimum of one 20 lb or 30 lb dry chemical extinguisher in each manifold area;
- One 15 lb carbon dioxide (CO<sub>2</sub>) extinguisher inside each control room door and in the hallway outside the switchgear cubicle door;
- One 20 lb or 30 lb dry chemical extinguisher in the pump room, positioned so that the travel distance from anywhere in the pump room to the extinguisher is no more than 9 m (30 ft); and

- One wheeled 150-lb extinguisher immediately inside or outside the most frequently used doorway of pump rooms/shelters; if two shelters are less than 15 m (50 ft) apart, one wheeled extinguisher may be placed between the two shelters.

Pipeline Maintenance (PLM) and Mechanic shops shall have accessible:

- Two 20 lb or 30 lb dry chemical extinguishers to be taken to pipeline repair jobs (including natural gas venting operations); the extinguishers shall be strategically located upwind of the work being completed and be immediately accessible;
- Additional 20 lb or 30 lb dry chemical extinguishers strategically located in PLM and welding shops based on Hazards; and
- One 30 lb ABC dry chemical extinguisher at each door and strategically located in work and welding shops.

Remote maintenance bases (NW) should have:

- Four 20-lb or 30-lb dry chemical extinguishers to be taken to Worksites as needed based on the Hazard Assessment at each site.

For Regional Operations remote maintenance bases (NW) that do not have ready access to fire extinguishers, refer to the Appendix of this Standard for the amount of fire extinguisher supplies required. If recommended amounts are not maintained, a current list of supplies shall be kept on file. If a worksite has access to a 24-hr. supply source, supplies kept on-site are at the discretion of the Operations Management.

Worksites with ABC-rated fire extinguishers shall establish access to a supply of ABC dry chemical extinguishing agent. Dry chemical extinguishers stored or used outside during winter conditions should be equipped with nitrogen gas cartridges rather than carbon dioxide gas cartridges.

In the event of a fire, workers shall immediately evacuate the area and only attempt to extinguish the fire only if it is safe to do.

For information on Fixed Extinguishing Systems (e.g., CO<sub>2</sub>, Halon, fixed hydrant) please see the Fire Protection, Extinguishment Engineering Equipment Specification.

## **6.6 FIRE PREVENTION AND PROTECTION**

Take all necessary precautions to prevent fires, including, but not limited to, the following:

- Eliminate/control ignition sources;
- Collect and secure garbage daily until it can be properly disposed;

- Store fuels, volatile solvents or any other flammable substances in containers that are clearly labeled, approved for their contents and located in a safe place away from ignition sources;
- Ensure flammable liquid containers are electrically bonded when liquids are being transferred from one to another;
- Flammable substances and quantities of chemical in excess of that needed for one day's work shall be stored in an approved storage Facility, isolated from the actual work areas;
- Post visible signs stating "NO SMOKING OR OPEN FLAMES WITHIN 8 METERS (25 FEET) OF THIS AREA" in areas where flammable substances are stored or used;
- Guard against clothing becoming contaminated with flammable liquids;
- Clean up spills promptly;
- Store and dispose of oily rags in approved containers of not more than 5-gallon capacity with self-closing lids designed to relieve internal pressure when subjected to fire exposure; and
- Implement other fire prevention controls based on an assessment of the hazards.

A fire protection plan may be required based on the potential fire hazards. Projects shall prepare a fire protection plan to prevent wildfires within or adjacent to the work areas. The plan shall contain effective prevention and control measures to address the potential for uncontrolled fires during hot work activities. Such measures may include the following:

- Controlling smoke and open flames;
- Controlling sparks from construction equipment and welding or grinding operations;
- Position fire suppression and other special equipment close to the Worksite and/or consulting with local fire departments about emergency response arrangements; and
- Providing fire extinguishers of appropriate size and type.

Burning shall not be permitted on Enbridge brownfield locations without prior authorization from the Operations Regional Manager. Greenfield burning will require Operations Regional Manager and/or Construction Manager or designate authorization. Greenfield burning is to be conducted in accordance with all regulatory requirements. When authorization to burn has been received, complete the following:

- Submit a detailed hazard assessment for approval prior to the commencement of burning;
- Obtain a burning permit from the authority having jurisdiction prior to commencement of burning and follow applicable legislation;

- Provide a continuous safety watch for at least 1 hour after the fire is completely extinguished; and
- Supply a minimum of two 30 lb (or 4 – 20 lb) dry chemical fire extinguishers that are readily available.

For the location of facility fire suppression equipment, see the location's Site Safety Plot Plan.

## **6.7 WINDSOCKS**

Position windsocks in locations that are:

- Away from wind currents caused by tanks or buildings;
- High enough to avoid influence from equipment (however, if located too high, an accurate indication of wind movement at ground level may not be possible); and
- Easily visible, day and night (e.g., illuminated locations) from the work location.

## **6.8 BOATS**

For additional required emergency preparedness safety equipment requirements for each boat size see the Appendix of this Standard.

## **6.9 VEHICLES**

Standard safety equipment required for Enbridge-owned and leased vehicles is located in the Appendix of this Standard.

## **6.10 MEDICAL PLAN**

A Medical Plan shall be established at Enbridge Locations where access to emergency services is limited. The plan shall include:

- Directions to nearest hospital(s) and to the worksite;
- Site GPS location;
- Relevant evacuation information (such as air ambulance, nearby medical transport, etc.); and
- Medical staff (as required).

Where applicable for Project work, the medical plan may be incorporated into the Project Emergency Response Plan.

## **6.11 EMERGENCY PROCEDURES AND EVACUATION PLAN**

The Area Manager (or designate) is responsible for ensuring the Emergency Procedures, Site Safety Plot Plan and Evacuation Maps are posted in a visible location at each company Facility

(i.e., main office, terminal, and pipeline maintenance shop) and Project location. All workers must be aware of where this information is located.

These procedures must include contacts for emergency services and special procedures if necessary for worksites in remote locations.

## **6.12 INSPECTIONS**

Inspections will be completed as determined by applicable Operations and Maintenance Manual requirements and the Inspection Standard.

## **7.0 TRAINING REQUIREMENTS**

Personnel working in the field must be knowledgeable in this Standard and may be assigned applicable training as driven by the Safety Training Matrix.

Reference the Health & Safety training syllabi and matrices for further information and training re-certification requirements.

## **8.0 RELATED DOCUMENTS**

Preventative Maintenance Tasks – First Aid Equipment

Preventative Maintenance Tasks – Fire Extinguishers

Preventative Maintenance Tasks – Light Vehicles

Preventative Maintenance Tasks – Automated External Defibrillators

Fire Protection, Extinguishment Engineering Equipment Specification

## **9.0 STANDARD REVIEW**

A subject matter expert (SME) will perform a technical review of this standard every two years to determine the accuracy of the content/information. The SME shall solicit input from applicable stakeholders to ensure the effectiveness of the standard. Any suggested changes must be reviewed and approved by the designated document owner.

## **10.0 REFERENCES**

Occupational Safety and Health Administration (OSHA)

- Medical & First Aid, 29 CFR 1910.151

Canada Labour Code, Part II:

- Canadian Occupational Health & Safety Regulations, First Aid, 16.1 PART XVI

ANSI Z358.1 Emergency Eyewash and Shower Equipment

Transport Canada Small Vessel Compliance Program

Federal Requirements and Safety Tips for Recreational Boats

**11.0 APPENDIX**

**11.1 SUMMARY OF REQUIRED SAFETY EQUIPMENT AT ENBRIDGE REGIONAL LOCATIONS**

Equipment	Tank Station	Delivery/ Injection Location	Pump Station	Location with PLM Crew	Location with Mechanical Dept.	Location with Electrical Dept.
AED	as required					
air mover	as required					
benzene monitor	1	as required	as required	1	1	---
bonding and grounding cable and connections	—	—	—	2	—	—
cascade system (for refilling air cylinders)	as required					
eye wash station	as required					
fire extinguisher and equipment	as required					
first aid kit	1	1	1	1	1	1
flashlight <sup>1</sup> (intrinsically safe) and extra batteries	as required <sup>2</sup>					
floodlight (portable, intrinsically safe)	—	—	—	2 <sup>1</sup>	—	—
ground mat	as required					
grounding cable: electrical cubicles (CAN) (USA) electrical dept. (ENB [NW])	1	—	1	—	—	—
hose line with egress bottle	as required	—	—	as required	—	—
lineman's belt	as required					
life buoy and rope	as required					
locks and tags for lockout	as required					
NGL <sup>2</sup> flare pistol and 4 min/10 max signal flare cartridges	1	1	1 set per NGL Facility			
NGL <sup>2</sup> personal protective equipment (required for Lines 1 and 5 service)	As per hazard assessment					
portable gas monitor	1 per Worker + additional as required by the Atmospheric Monitoring Standard					
rubber gloves (electrician) and leather gauntlets	1 pair	—	1 pair	as required	—	2 pairs
safety harness and lanyard	as required					
Self-Contained Breathing Apparatus (SCBA)	as required			4 <sup>3</sup> (CAN) (USA) 2 (ENB [NW])	1	—
warning signs	as required					
windsock	1	1	1	2 (portable)	as required	

**NOTES**

Projects will determine within their project safety plan whether the safety equipment is required on site based on hazardous conditions present

As required—determined by Area Manager or Project Director or designated equivalent



1. Flashlights/floodlights shall carry the Underwriters Laboratories label "Approved for use in Class 1 Div. 1 Hazardous Locations"  
When working in areas without emergency lighting facilities, approved flashlights/floodlights shall be available for immediate use.
2. Equipment only required at facilities where NGL is present.
3. If SCBA are already present at the location PLM is travelling to then PLM can reduce the amount they need to bring by however many are located at their work destination.

## 11.2 BOAT SAFETY EQUIPMENT REQUIREMENTS – CAN

Boat Size	Standard Equipment
< 6 m (19' 8")	<ul style="list-style-type: none"> <li>• life jacket or PFD that meet the requirements in section 6.1.7.2 of the Personal Protective Equipment Standard for each person on board</li> <li>• buoyant heaving line at least 15 m long</li> <li>• reboarding device (if vertical climbing height to reboard boat from water is over 0.5 m (1' 18"))</li> <li>• manual propelling device or 1 anchor and at least 15 m (49' 3") of cable, rope or chain</li> <li>• bailer or manual bilge pump</li> <li>• watertight flashlight or 3 flares of type A, B, or C</li> <li>• sound signaling device or appliance</li> <li>• navigation lights (only required if operated in fog, after sunset, before sunrise, or in periods of restricted visibility)</li> <li>• 5BC fire extinguisher- Only if the boat has an inboard engine, enclosed compartments where fuel or flammable and combustible materials are stored, closed living spaces, or permanently installed fuel tanks.</li> </ul>
> 6 m (19'8") & < 9 m (29'6")	<ul style="list-style-type: none"> <li>• life jacket or PFD that meet the requirements in in section 6.1.7.2 of the Personal Protective Equipment Standard for each person on board</li> <li>• buoyant heaving line at least 15 m long or 1 lifebuoy attached to a buoyant line at least 15 m (49' 3") long</li> <li>• reboarding device (if vertical climbing height to reboard boat from water is over 0.5 m (1' 18"))</li> <li>• manual propelling device or 1 anchor and at least 15 m (49' 3") of cable, rope or chain</li> <li>• bailer or manual bilge pump</li> <li>• watertight flashlight or 6 flares of type A, B, or C</li> <li>• sound signaling device or appliance</li> <li>• navigation lights (only required if operated in fog, after sunset, before sunrise, or in periods of restricted visibility)</li> <li>• 5BC fire extinguisher- Only if the boat has an inboard engine, enclosed compartments where fuel or flammable and combustible materials are stored, closed living spaces, or permanently installed fuel tanks.</li> <li>• if equipped with a heating device or cooking appliance, 1 additional 5BC fire extinguisher</li> </ul>
> 9 m (29'6") & < 12 m (39'4")	<ul style="list-style-type: none"> <li>• life jacket or PFD that meet the requirements in in section 6.1.7.2 of the Personal Protective Equipment Standard for each person on board</li> <li>• buoyant heaving line at least 15m long or 1 lifebuoy attached to a buoyant line at least 15 m (49' 3") long</li> <li>• reboarding device (if vertical climbing height to reboard boat from water is over 0.5 m (1' 18"))</li> <li>• anchor and at least 30 m (98' 5") of cable, rope or chain</li> <li>• manual bilge pump or bilge-pumping arrangements</li> <li>• watertight flashlight</li> <li>• 12 flares of type A, B, C or D not more than 6 of which are type D</li> <li>• sound signaling device or appliance</li> <li>• navigation lights</li> <li>• magnetic compass</li> <li>• 10BC fire extinguisher</li> </ul>



---

	<ul style="list-style-type: none"><li>• if equipped with a heating device or cooking appliance, 1 additional 10BC fire extinguisher</li></ul>
--	---

### 11.3 BOAT SAFETY EQUIPMENT REQUIREMENTS – USA

Boat Size	Standard Equipment
<16 ft.	<ul style="list-style-type: none"> <li>USCG<sup>2</sup>-approved life jacket per occupant</li> <li>electric distress light or, if operating between sunset and sunrise, 3 combination (for both day/night use) red flares</li> <li>Class B-1 fire extinguisher- Only if the boat has an inboard engine, enclosed compartments where fuel or flammable and combustible materials are stored, closed living spaces, or permanently installed fuel tanks.</li> <li>sound signaling device (e.g., whistle/horn) audible for ½ mi / 4 to 6 sec</li> <li>red and green navigational sidelights lights visible from at least 1 mi. Navigation lights are only required if you operate the boat after sunset, before sunrise or in periods of restricted visibility (fog, falling snow, etc.)</li> <li>an all-round white light, or a masthead light and a sternlight; all visible from at least 2 mi</li> </ul>
>16 ft. to <26 ft.	<ul style="list-style-type: none"> <li>USCG<sup>1</sup>-approved life jacket per occupant and 1 Type IV personal flotation device</li> <li>orange distress flag or electric distress light, or 3 handheld or floating orange smoke signals and 1 electric distress light, or 3 handheld, meteor or parachute type combination (for both day/night use) red flares</li> <li>Class B-1 fire extinguisher- Only if the boat has an inboard engine, enclosed compartments where fuel or flammable and combustible materials are stored, closed living spaces, or permanently installed fuel tanks.</li> <li>sound signaling device (e.g., whistle/horn) audible for ½ mi / 4 to 6 sec</li> <li>red and green navigational sidelights lights visible from at least 1 mi. Navigation lights are only required if you operate the boat after sunset, before sunrise or in periods of restricted visibility (fog, falling snow, etc.)</li> <li>an all-round white light, or a masthead light and a sternlight; all visible from at least 2 mi</li> </ul>

**NOTES**

1. Check your state and local regulations for any additional safety equipment requirements
2. United States Coast Guard

In addition, vessels operating in the State of New York also shall be equipped with an anchor and line of sufficient strength to provide the vessel with safe anchorage.

### 11.4 SUMMARY OF SAFETY EQUIPMENT REQUIREMENTS FOR ENBRIDGE VEHICLES

	SUV	½ T Pickup	¾ T Pickup	≥1 T Pickup	Crane/ Boom Truck/ Knuckle Truck	Semi/Tractor	Emergency Response Vehicle	Leased Vehicle
area maps	as required							
booster cable	1	1	1	1	1	1	1	1
chain, rope and booster to secure loads (ENB [NW]) <sup>1</sup>	as required							
fire extinguisher—5 or 10 lb. dry chemical extinguisher	1	1	1	—	—	—	1	as required
fire extinguisher—30 lb. dry chemical extinguisher	—	—	—	Minimum 1	2	2	—	as required

**EMERGENCY PREPAREDNESS-  
PERSONAL SAFETY STANDARD**

Version #: 1.5  
Version Date: 2024-03-27



				Additional based on hazard assessment				
first aid kit	1	1	1	1	1	1	1	1
flags/red cloth	as required							
flashing amber light	as required							
flashlight	1	1	1	1	1	1	1	1
NGL flare pistol and 4 min/10 max signal flare cartridges <sup>2</sup>	as required							
shovel	as required							
snow brush	as required							
spare tire	1	1	1	as required				
standard tool kit	as required							
tire pressure gauge	1	1	1	1	1	1	1	1
tire inflator sealer	as required							
tire jack	1	1	1	1	1	1	1	1
vehicle recovery strap	as required							
warning reflector / road hazard triangles	1	1	3	3	3	3	1	as required
winter survival kit	as required							

NOTES: as required—determined by Area Manager or Project Director or designated equivalent

1. Required in the Northwestern Region

2. Required in locations where NGL is present

**11.5 INSPECTION FREQUENCY FOR FIRE SUPPRESSION EQUIPMENT**

Type of Equipment	Inspection Frequency
portable fire extinguishers (hand-held)	monthly when placed in service after repairs and use
portable fire extinguishers (wheeled)	monthly when placed in service after repairs and use
fixed systems (hydrant systems)	annually when placed in service after repairs and use
fixed systems (CO <sub>2</sub> and Halon Systems)	annually (minimum) <sup>1</sup> monthly (visual inspections) <sup>2</sup> semiannually (for high-pressure cylinders) <sup>3</sup> when placed in service after repairs and use
foam trailers	monthly <sup>4</sup> when placed in service after repairs and use

**NOTES**

1. A Qualified service contractor shall inspect and test systems annually.
2. A Qualified employee shall visually inspect systems monthly.
3. A Qualified service contractor shall inspect high-pressure cylinders semiannually. During the inspection, cylinders shall be weighed, and the date of the last hydrostatic test noted. Any container that shows a loss in net content of more than 10% shall be refilled or replaced.
4. Each region/area shall assign a Qualified Employee to inspect foam trailers using the Foam Trailer Check Sheet.

## 11.6 MAINTENANCE FREQUENCY FOR PORTABLE FIRE EXTINGUISHERS

	Maintenance Frequency	Hydrostatic Test Frequency
cartridge-type dry chemical extinguishers stored on vehicles	<ul style="list-style-type: none"> <li>annually</li> <li>if evidence of corrosion or mechanical damage</li> </ul>	every 12 years
cartridge-type dry chemical extinguishers stored in buildings or outdoors	<ul style="list-style-type: none"> <li>annually, not to exceed 365 days</li> <li>if evidence of corrosion or mechanical damage</li> </ul>	every 12 years
CO <sub>2</sub> extinguishers	<ul style="list-style-type: none"> <li>conductivity test annually on all CO<sub>2</sub> hose assemblies</li> <li>whenever evidence of corrosion or mechanical damage found on tank</li> </ul>	every 5 years
Rechargeable Stored Pressure Extinguishers <sup>1</sup>	<ul style="list-style-type: none"> <li>every 6 years<sup>2</sup></li> </ul>	every 12 years
Halon stored pressure extinguishers	<ul style="list-style-type: none"> <li>if evidence of corrosion or mechanical damage</li> </ul>	every 12 years
liquid charged AFFF <sup>3</sup> extinguishers	<ul style="list-style-type: none"> <li>every 3 years</li> <li>if evidence of corrosion or mechanical damage</li> </ul>	every 5 years
wheeled fire extinguishers	<ul style="list-style-type: none"> <li>annually</li> <li>if evidence of corrosion or mechanical damage</li> </ul>	every 12 years

### NOTES

1. Non-rechargeable stored pressure extinguishers are not internally inspected or hydrostatically tested. These extinguishers are removed from service at a maximum interval of 12 years from the date of manufacture, or sooner when exhibiting signs of corrosion or mechanical damage.
2. Rechargeable stored pressure extinguishers shall be emptied and subjected to the applicable internal examination procedure as outlined in the manufacturer service manual and NFPA 10.7.3.
3. Aqueous Film-Forming Foam

**11.7 HYDROSTATIC TEST FREQUENCY FOR CARTRIDGES AND CYLINDERS**

<b>Cartridge/Cylinder</b>	<b>Hydrostatic Test Frequency</b>
nitrogen cartridges on hand-held extinguishers	exempt (CAN), every 10 years (USA)
Ansul CO <sub>2</sub> cartridges on hand-held extinguishers	exempt
nitrogen cylinders on wheeled fire extinguishers	every 5 years

**11.8 STOCK AMOUNTS—FIRE EXTINGUISHER SUPPLIES**

<b>Location</b>	<b>Supplies</b>	<b>Minimum Quantity<sup>1</sup></b>
Attended pump station	Purple K	500 lb.
Pump station—ENB (NW)	ABC, Plus 50 or Purple K	500 lb.
Delivery location and electric station with 150 lb extinguisher(s)	Purple K	200 lb.
PLM shop or designated location	Purple K	500 lb.
Remote maintenance base—ENB (NW)	ABC, Plus 50 or Purple K	200 lb.
Worksite with 350 lb nitrogen extinguisher(s)	nitrogen cylinders/cartridges	1
Worksite with 150 lb nitrogen extinguisher(s)	nitrogen cylinders/cartridges	1
location with 20 lb or 30 lb nitrogen extinguisher(s)	nitrogen cylinders/cartridges	half as many as extinguishers in outdoor use (2 minimum)
location with 4 lb, 10 lb, 20 lb, or 30 lb CO <sub>2</sub> extinguisher(s)	CO <sub>2</sub> cartridges	half as many as extinguishers in indoor use

**NOTES**

1. or as determined by the Area Manager



---

## CHANGE LOG

Section	Version 1.4	Version 1.5
Entire Document		Clerical corrections including spelling, grammar, and document names.

<End of Document>





---

# Standard

---

## Environmental Conditions

---

**Effective Date:** 2019-03-30  
**Version #:** 3.1  
**Version Date:** 2024-03-27

---



This page intentionally left blank





This page intentionally left blank

---

## Table of Contents

1.0	Purpose .....	3
2.0	Scope .....	3
3.0	Prerequisites.....	3
4.0	Definitions & Acronyms .....	3
5.0	Roles & Responsibilities.....	4
6.0	Standard – Specific Requirements.....	4
6.1	Lightning .....	5
6.2	High Wind Events .....	5
6.3	Heavy Snow.....	6
6.4	Heavy Rain .....	7
6.5	Extreme Heat/Heat Stress.....	7
6.6	Extreme Cold .....	7
6.7	Journey Management.....	8
6.8	Working Alone .....	8
6.9	Working after Sunset and before sunrise .....	10
6.10	Sanitary Facilities .....	10
6.11	Working on Ice or Near Water .....	11
6.11.1	Working On Ice:.....	11
6.11.2	Winter Road & Ice Crossing requirements: .....	11
6.11.3	Working Near Water: .....	11
6.12	Wilderness Conditions.....	12



---

7.0	Training Requirements .....	13
8.0	Related Documents .....	13
9.0	Standard Review .....	13
10.0	References .....	13
11.0	Appendix.....	14
11.1	Table 1-Heat Index from Temperature and Relative Humidity Readings .....	14
11.2	Table 2 -Correction Factor (in 0F) for Radiation Heat, Clothing, and Workload .....	15
11.3	Work-Warming Regimen .....	16
	Change Log.....	17

## **1.0 PURPOSE**

The purpose of this standard is to ensure that people leaders and workers are aware of the hazards associated with various environmental conditions that can be present at all Enbridge facilities and work locations.

## **2.0 SCOPE**

This standard applies to LP Operations and to projects being completed for LP.

Contractors and subcontractors shall comply with Enbridge health and safety requirements set out in this standard, as articulated within applicable contractor safety specifications. If a contractor or subcontractor has a health and safety standard or policy materially different from Enbridge's, the contractor/subcontractor shall follow the most stringent requirement. Contractors and subcontractors are still obligated to meet the requirements of all applicable laws related to this standard.

In the event a contractor's or subcontractor's standard exceeds the requirements of this standard, Enbridge may, in its sole discretion, choose to adopt the contractor's or subcontractor's standard for any given contract or work order.

## **3.0 PREREQUISITES**

Emergency Preparedness - Personal Safety Standard

Hazard Assessment, Elimination & Control Standard

Safe Work Permit and Work Authorization Standard

Personal Protective Equipment (PPE) Standard

## **4.0 DEFINITIONS & ACRONYMS**

*IDLH* – Immediately Dangerous to Life or Health. This is an atmospheric concentration of any toxic, corrosive or asphyxiate substance that would pose an immediate threat to life; would cause irreversible or delayed adverse health effects; or would interfere with a worker's ability to escape from a dangerous or hazardous atmosphere.

*GPS* – Global Positioning System

*GVW* – Gross Vehicle Weight – total weight of a road vehicle when loaded i.e., includes the weight of the vehicle itself plus fuel, freight, passengers, attachments and equipment. Experience has shown that weighing the vehicle on a scale is the most accurate way to determine the GVW.

*PDF* – Personal Floatation Device

*PPE* – Personal Protective Equipment

*ROW* – Right Of Way

*SCBA* – Self Contained Breathing Apparatus

*TLV* – Threshold Limit Value of a chemical substance is a level to which it is believed a worker can be exposed day after day for a working lifetime without adverse effects.

*UV* – Ultraviolet Radiation - that portion of the electromagnetic spectrum between X-rays and visible light or between 40 and 400 nanometer (nm) wavelengths. The primary source of UV radiation is the sun. There are also a number of artificial sources, such as tanning booths, welding and halogen lights. The different sources come with some unique hazards, depending on the wavelength range of the emitted UV radiation.

## **5.0 ROLES & RESPONSIBILITIES**

People leader shall:

- Provide sufficient resources to effectively implement this standard, and
- Ensure work is postponed, altered or shutdown as required by environmental conditions.

Employees shall:

- Be knowledgeable in the requirements and expectations of this standard, and
- Be able to recognize the signs and symptoms of cold and heat stress.

Safety Team shall:

- Provide timely advice, support and assistance to people leaders and employees in the implementation of this standard.

Safety Shared Services shall:

- Be responsible for the maintenance and continuous improvement of this standard.

## **6.0 STANDARD – SPECIFIC REQUIREMENTS**

The safe work permit issuer shall check weather reports prior to issuing and approving permits. Permits suspended due to inclement weather shall be revalidated once weather conditions improve.

If potential or imminent severe weather is forecast, the hazards due to severe weather need to be identified and controls implemented. Controls can include, but are not limited to:

- Having workers work remotely;
- Sending workers home from Enbridge locations to avoid travel in severe weather,
- Closing offices and worksites;
- Sheltering in place; and
- Suspending work until inclement weather has passed.



## 6.1 LIGHTNING

To minimize the risk posed by lightning, workers should take adequate shelter prior to electrical storms. Where practicable, use lightning detectors to supplement visual and auditory detection of electrical storms; use the detector’s specifications to determine detection ranges and action plans. Suggested action ranges for a three stage warning criteria are:

Range	Alert	Action
20-40 miles (32-64 km)	Yellow Alert	Threat is possible; Monitor the storm direction and local weather conditions.
10-20 miles (16-32 km)	Orange Alert	Threat is probable; Prior to storm: Suspend work activities and seek shelter. Post storm: begin to remobilize and resume work activities
10 miles (16km)	Red Alert	Danger - outdoor activities should not occur

If lightning detectors are not available, at the first identification of lightning or thunder, workers shall seek shelter and outside work shall not recommence until at least 30 minutes after lightning and thunder are no longer observed.

## 6.2 HIGH WIND EVENTS

Stand clear of roadways or train tracks because a gust may blow you into the path of an oncoming vehicle. Use handrails where available on outdoor walkways, and avoid other elevated areas, such as roofs, without adequate railings. Watch for flying debris. Tree limbs may break and street signs may become loose during strong wind gusts. Keep an eye toward nearby balconies for loose objects that may fall.

If driving, pull your vehicle off the pavement as far as possible, stop and set the emergency brake. If you can't pull off the roadway, proceed at a speed suitable for visibility, turn on lights and sound horn occasionally. Use the painted center line to help guide you. Look for a safe place to pull off the roadway. Never stop on the traveled portion of the roadway.

When wind conditions exceed 50 km/hr (30 mph) or more, the hazard assessment shall be reviewed and adjusted to take the wind conditions into consideration, or the activity shall be suspended until wind conditions are more favorable. Consider other hazards such as dust and debris, secure any loose materials.

Refer to the Hoisting and Rigging standard for considerations when performing hoisting and rigging operations in high winds.

In the event of a tornado, an underground area provides the best protection from a tornado. If an underground shelter is unavailable, consider doing the following:

- Seek a small interior room or hallway on the lowest floor possible;
- Stay away from doors, windows and outside walls;
- Stay in the center of the room, and avoid corners because they attract debris; and
- Choose a room constructed with reinforced concrete, brick or block; with no windows; and with a heavy concrete floor or roof system overhead.

### **6.3 HEAVY SNOW**

To prevent slips, trips and falls, clear snow and ice from walking surfaces as quickly as possible after a winter storm. When walking on snow or ice is unavoidable, workers should be trained to:

- Wear footwear that has good traction and insulation (e.g., insulated and water-resistant boots or rubber over-shoes with good rubber treads), and
- Take short steps and walk at a slower pace to react quickly to changes in traction.

When driving in heavy snow, drive below posted speed limits because they are intended for ideal driving conditions. Other best practices include:

- Be alert. Black ice will make a road look like shiny new asphalt. Pavement should look grey-white in winter;
- Do not use cruise control. Winter driving requires you to be in full control at all times;
- Reduce your speed while approaching intersections covered with ice or snow;
- Allow for extra travelling time or delay a trip if the weather is inclement;
- Drive with low-beam headlights on. Not only are they brighter than daytime running lights but turning them on also activates the taillights. This lighting makes your vehicle more visible;
- Lengthen your following distance behind the vehicle ahead of you. Stopping distance on an icy road is double that of stopping on a dry one. For example, when driving at the speed of 60 km/h (37.3 mph) stopping distance is from around 45 metres (145 ft.), which increases to 80 metres (over 260 ft.) on an icy road surface;
- Steer with smooth and precise movements. Changing lanes too quickly and jerky steering while braking or accelerating can cause skidding;
- Be aware and slow down when you see a sign warning that you are approaching a bridge. Steel and concrete bridges are likely to be icy even when there is no ice on the ground surface (because bridges over open air cool down faster than roads which tend to be insulated somewhat by solid ground);
- Consider getting off the road before getting stranded if the weather is worsening;
- Keep a safe distance back from snow plows and salt/sand/anti-icing trucks; and

- Never pass a snow plow due to whiteout conditions and ridge of snow created by the plow.

## **6.4 HEAVY RAIN**

Avoid driving on flooded access roads or ROWs and avoid crossing bridges if water level is high and fast flowing. Stay out of trenches, excavations, flood zones/plains and below ground level unsheltered entry points.

Take cover during hailstorms and expect slippery walking and driving conditions. Be aware of possible damage to trees and power lines due to ice buildup and avoid travel in these conditions.

## **6.5 EXTREME HEAT/HEAT STRESS**

Consult the climatic condition reports from your local weather service during field level hazard assessment, and apply the correction factor, and repeat the hazard assessment process whenever conditions change (see Section 11.1 Table 1).

Determine the amount of cloud cover; the exertion level of the work being conducted and the type of clothing being worn to calculate the correction factor (see Section 11.2 Table 2). To accomplish this, follow the best practices below where applicable:

- Reduce the physical demands of work (e.g., excessive lifting);
- Provide shade and recovery areas (e.g., air-conditioned enclosures, rooms for rehydration);
- Use shifts (e.g., early morning, cool part of the day, night work);
- Use relief workers;
- Use worker pacing;
- Take steps to protect workers from exposure to UV radiation such as sunscreen, PPE, and clothing with UV protection and wide brims;
- Assign extra workers, limit worker occupancy or the number of workers present, especially in confined or enclosed spaces;
- Train workers to recognize the signs and symptoms of heat stress; and to know and follow heat stress prevention measures; and
- Provide water nearby on the worksite (workers should drink about one cup of water every 20 to 30 minutes, even if they are not thirsty).

## **6.6 EXTREME COLD**

Wear layers of warm clothing and cover as much exposed skin as possible. Ensure workers can recognize signs and symptoms of cold related conditions in other workers. Refer to section 11.3 Work-Warming Regimen for the Threshold Limit Values.

---

## **6.7 JOURNEY MANAGEMENT**

People Leaders with staff (including those with staff in offices) that may be travelling as part of their role shall develop a Journey Management Plan when workers are travelling more than 2 continuous hours. The plan shall include:

- Contact information and travel schedule (identifying the route, timeline of travel and stops to be made);
- Emergency contacts and emergency response guidelines;
- Communication frequency and method of communication;
- Weather and travel considerations; and
- Changes to travel plans.

If the worker's journey is hindered by weather or other emergencies, the individual's first priority should be to move to a safe location, contact emergency personnel if necessary, then contact the worker's People Leader as soon as reasonably possible.

## **6.8 WORKING ALONE**

Working alone practices shall be developed for Enbridge locations. The practices shall include considerations for both normal and unexpected work situations.

This includes workers required to travel alone to remote locations or where there is no routine interaction with other people. Working alone practices shall include, but not be limited to:

- Specific controls for identified hazards,
- Effective communication devices/systems;
- An escalation strategy for when contact with a Worker is lost;
- Rules setting out types of work that cannot be completed while working alone, including, but not limited to:
  - Confined space entry work;
  - Certain high voltage electrical work (see Electrical Safety Standard);
  - Open system work;
  - Energized substation work;
  - Work in excavations;
  - Where personal fall protection is required;
  - Working with immediately dangerous to life or health (IDLH) chemicals [identified by the Safety Data Sheet (SDS)];

- Using supplied air equipment or SCBA;
- Work involving a risk of drowning;
- Work on equipment that cannot be locked out once a guard or other safety mechanism is removed; and
- Operation of any motorized or manual materials handling equipment where a spotter is required.

The practices shall also ensure that workers do not work alone unless appropriate safety precautions are taken, which may include but are not limited to:

- Personal atmospheric monitoring,
- Protection from weather conditions; and
- Frequent communication at specific intervals.

Workers shall not work alone in conditions that are or may be considered Immediately Dangerous to Life or Health (IDLH).

The hazard assessment shall determine:

- The hazards for each type of work being performed;
- The hazards for each worksite where workers will potentially work alone;
- The length of time the worker is out of contact; and
- Factors and considerations to ensure the availability of help.

Working alone controls may include, but are not limited to:

- “Man down” or lone worker alarm or pendant;
- Provision for emergency rescue and first aid;
- Frequent “check-ins” with a designated contact person that:
  - Are visual or two-way contacts (or, a one-way system may be acceptable if it allows the worker to call or signal for help and will send a call for help if the worker does not reset the device after a predetermined interval);
  - Are of a frequency not to exceed 2 hours (in some cases the duration could be shorter based on the hazard assessment); and
  - Activates the escalation strategy if contact cannot be made, or there are unusual delays in re-establishing contact.

Effective means of communication include, but are not limited to:

- Portable or cell telephone;

- Walkie-talkie;
- Personal alarm;
- Periodic site visits;
- Electronic methods, such as online web applications;
- Check-in system and requirement for updating an individual's status while working alone;
- GPS-based communication device (e.g., SPOT Messenger); and
- Use of software or hardware to assist with communication in circumstances of poor network coverage.

## **6.9 WORKING AFTER SUNSET AND BEFORE SUNRISE**

Work after dusk shall not be permitted unless the following conditions are met:

- For Contractor work, prior approval shall be obtained from the Enbridge Representative;
- There is a minimum of two (2) workers, or communications exist to outside areas to request assistance if required;
- Adequate lighting is provided to illuminate the work; and
- For Contractor work, regular "night shift" work shall require prior project approval.

Night security workers shall:

- Not work alone, unless they have an adequate communication plan in place to contact other workers or emergency assistance as needed; and
- Maintain communications and check in at least every two hours with a control room or other workers familiar with the Worksite and the Emergency Response Plan for that project and/or operating facility.

## **6.10 SANITARY FACILITIES**

People Leaders or the Contractor shall:

- Ensure adequate sanitary facilities at or near the Worksite for the size and type of Workforce to be employed;
- Provide workers with sufficient drinking fluids and provide access to toilets and hand washing facilities in accordance with Applicable Legislation; and
- Ensure that the Ground Disturbance Standard is referenced prior to securing a portable facility into the ground.

Workers shall:

- Use the facilities provided;
- Ensure that all facilities are adequately serviced and properly stocked; and
- Ensure facilities are adequately secured against unintentional movement.

## **6.11 WORKING ON ICE OR NEAR WATER**

This section is to prevent the risk of drowning or injury while working at the edge of any body of water and either on or near any frozen body of water.

This section provides the minimum requirements when working on ice or near water.

### **6.11.1 *WORKING ON ICE:***

For guidance on Emergency Response activities working on frozen waterbodies and ice assessments associated with Emergency Response activities, see Inland Spill Response Tactics Guide.

When personnel are conducting work on ice, an ice assessment is required based on local regulations or requirements. These may be completed by an Enbridge person familiar with local requirements or a third party.

Before working on ice, the people leader shall:

- Ensure a site-specific ice assessment has been completed (consider the involvement of an engineer or 3rd party consultant to review/develop site-specific requirements)
- Ensure a hazard assessment is completed, outlining the hazards and mitigation strategies associated with the work (e.g., thin ice identification, crossing intervals, weight limits, emergency response).

### **6.11.2 *WINTER ROAD & ICE CROSSING REQUIREMENTS:***

When travelling with vehicles on frozen covers or ice crossings an ice assessment must be conducted prior to traveling across frozen creeks, rivers, streams, swamps, or other bodies of water. These ice assessments shall be conducted in accordance with local regulatory requirements by an engineer or a third party.

Winter roads built, opened, and monitored by local jurisdictions may be used by Enbridge personnel without an Enbridge initiated ice assessment.

### **6.11.3 *WORKING NEAR WATER:***

The following guidelines shall be followed when working within 2 m (6 ft) from the edge of an unguarded body of water or plastic liner of lagoon/pond/basin. The minimum requirement is a PFD within 2 m (6 ft.) of the waters edge.

Perform hazard assessment to identify additional PPE (e.g., Mustang suit), protective barrier (e.g., safety net or fall protection system) and emergency response (e.g., life buoy/ring with adequate length of rope/line, other rescue equipment, back-up personnel) requirements.

Other considerations for emergency equipment could include boats (either powered or non-powered), back up personnel, additional lifelines and professional emergency responders. These considerations should also take into account the water temperature, depth, and flow rate.

## **6.12 WILDERNESS CONDITIONS**

Working in outdoor locations adds the risk of worker exposure to wilderness types of hazards. Wilderness hazards and emergency response measures, should be taken into consideration as part of the Field Level Hazard Assessment (FLHA) process and may include, but are not limited to:

- Poisonous plants (e.g., poison ivy, poison oak, poison sumac, etc.). Typical exposures may include:
  - direct contact of poisonous plant with skin
  - indirect contact (touching tools, animals, or clothing contaminated with poisonous plant sap (urushiol))
  - inhalation of particles containing urushiol from burning plants

The following protection measures are recommended:

- wear long sleeves, long pants, and gloves
  - wash exposed clothing separately in hot water with detergent
  - apply barrier cream to your skin (lotions containing bentoquatam may offer some protection from usushiol)
  - after use, clean tools with rubbing alcohol or soap and copious amounts of water. (Urushiol can remain active on the surface of objects for up to five years)
- Insects. Typical exposures may include:
    - mosquito bites
    - bee or wasp stings
    - tick bites
    - spider bites

The following protection measures are recommended:

- wear long sleeves, long pants, and gloves
  - use insect repellent
- Wildlife presence (e.g. bears, cougars, snakes, etc.). Typical exposures may include:
    - animal attacks
    - snake bites

The following protection measures are recommended:



- carry bear spray (note: bear spray shall never be stored in vehicle cabs or helicopters)
- use a wildlife monitor
- wear deep boots (e.g. snake gaiters)

## **7.0 TRAINING REQUIREMENTS**

Personnel working in the field must be knowledgeable in this Standard and may be assigned applicable training as driven by the Safety Training Matrix.

Reference the Health & Safety training syllabi and matrices for further information and training re-certification requirements.

## **8.0 RELATED DOCUMENTS**

Not Applicable

## **9.0 STANDARD REVIEW**

A subject matter expert (SME) will perform a technical review of this standard every two years to determine the accuracy of the content/information. The SME shall solicit input from applicable stakeholders to ensure the effectiveness of the standard. Any suggested changes must be reviewed and approved by the designated document owner.

## **10.0 REFERENCES**

- American Conference of Governmental Industrial Hygienists (ACGIH) Threshold Limit Values for Chemical Substances and Physical Agents and Biological Exposure Indices
- Canada Labour Code, Part II:
  - Canadian Occupational Health & Safety Regulations, Hazard Assessment, 11.03
  - Canadian Occupational Health & Safety Regulations, Part IX Sanitation
- British Columbia OHS Regulation Part 8.26, 8.27, 8.28
- Best Practice for Building and Working Safely on Ice Covers in Alberta
- A Field Guide to Ice Construction Safety – Northwest Territories Transportation
- Engineering Guidelines and Best Practice for Working on Floating Ice and Frozen Muskeg
- Enbridge Inland Spill Response Tactics Guide



**11.0 APPENDIX**

**11.1 TABLE 1 - HEAT INDEX FROM TEMPERATURE AND RELATIVE HUMIDITY READINGS**

Relative Humidity	Actual Temperature ° F (° C)								
	70 (21.1)	75 (23.9)	80 (26.7)	85 (29.4)	90 (32.2)	95 (35.0)	100 (37.8)	105 (40.6)	110 (43.3)
0%	70 (21.1)	75 (23.9)	80 (26.7)	85 (29.4)	90 (32.2)	95 (35.0)	100 (37.8)	105 (40.6)	110 (43.3)
10%	70 (21.1)	75 (23.9)	80 (26.7)	85 (29.4)	90 (32.2)	95 (35.0)	100 (37.8)	105 (40.6)	110 (43.3)
20%	70 (21.1)	75 (23.9)	80 (26.7)	85 (29.4)	90 (32.2)	96.8 (36.0)	102.2 (39.0)	109.4 (43.0)	116.6 (47.0)
30%	70 (21.1)	75 (23.9)	80.6 (27.0)	87.8 (31.0)	95 (35.0)	102.2 (39.0)	109.4 (43.0)	118.4 (48.0)	125.6 (52.0)
40%	70 (21.1)	77.0 (25.0)	84.2 (29.0)	91.4 (33.0)	98.6 (37.0)	107.6 (42.0)	116.6 (47.0)	125.6 (52.0)	
50%	71.6 (22.0)	80.6 (27.0)	87.8 (31.0)	95 (35.0)	104 (40.0)	113 (45.0)	122 (50.0)		
60%	75.2 (24.0)	82.4 (28.0)	91.4 (33.0)	98.6 (37.0)	109.4 (43.0)	118.4 (48.0)	129.2 (54.0)		
70%	77.0 (25.0)	86 (30.0)	95 (35.0)	104 (40.0)	113 (45.0)	123.8 (51.0)			
80%	80.6 (27.0)	87.8 (31.0)	98.6 (37.0)	107.6 (42.0)	118.4 (48.0)				
90%	82.4 (28.0)	91.4 (33.0)	100.4 (38.0)	111.2 (44.0)	122 (50.0)				
100%	84.2 (29.0)	95 (35.0)	104 (40.0)	114.8 (46.0)	127.4 (53.0)				

\* This table is based on: working conditions with little or no radiant heat, workers wearing regular summer clothing, un-acclimatized workers doing moderate work or acclimatized workers doing heavy work.



**11.2 TABLE 2 - CORRECTION FACTOR (IN 0°F) FOR RADIATION HEAT, CLOTHING, AND WORKLOAD**

Clothing	100% cloud cover		60% cloud cover		30% cloud cover		0% cloud cover		Work Type
	°F	°C	°F	°C	°F	°C	°F	°C	
FR + Vest	1	0.5	2	1	4	2	4	2	Light work
	2	1	3	1.5	4	2	5	2.5	Moderate work
	4	2	4	2	7	3.5	8	4	Heavy work
Clothing	100% cloud cover		60% cloud cover		30% cloud cover		0% cloud cover		Work Type
	°F	°C	°F	°C	°F	°C	°F	°C	
FR + Regular Tyvek <sup>1</sup> + Vest	4	2	6	3	8	4	9	4.5	Light work
	6	3	8	4	9	4.5	11	5.5	Moderate work
	9	4.5	10	5	12	6	15	7.5	Heavy work

\*\*The numbers in Table 2 indicate an increase in the heat index as a correction factor to reflect cloud coverage, clothing and type of work. For example; performing heavy work with FR clothing + vest with 100% cloud coverage would add 4°F (2°C) to the heat index to obtain the final heat index. The work rest schedule would have to be determined based on the final heat index.

<sup>1</sup> Regular Tyvek suit is made of polypropylene. This is considered a breathable fabric. (Chemical resistant suits are coated with polyethylene. This type of garment is impermeable with no breathability.)

Examples of work types:

Rest - Sitting

Light work - Sitting with light manual work with hands or hands and arms and driving. Standing with occasional walking

Moderate work – Normal walking, sustained moderate hand and arm work, moderate arm and leg work, moderate arm and trunk work, light pushing and pulling

Heavy work – Intense arm and trunk working, carrying, shoveling, and manual sawing, pushing and pulling heavy loads

Very Heavy – Very intense activity at fast to maximum pace, e.g., shoveling wet sand

### 11.3 WORK-WARMING REGIMEN

*"If work is performed continuously in the cold at or below a WCT\* of -7°C (19.4°F), heated warming shelters (tents, cabins, rest rooms, etc.) should be made available nearby. The workers should be encouraged to use these shelters at regular intervals, the frequency depending on the severity of the environmental exposure. Indications for immediate return to the shelter are the onset of heavy shivering; frostnip; or the feeling of excessive fatigue, drowsiness, irritability, or euphoria. When entering the heated shelter, the outer layer of clothing should be removed and the remainder of the clothing loosened to permit sweat evaporation, or a change of dry work clothing should be provided as necessary to prevent workers from returning to their work with wet clothing. Dehydration, or the loss of body fluids, occurs insidiously in the cold environment and can impair work performance. However, dehydration likely does not increase susceptibility to cold injuries. Workers can drink a variety of fluids (milk, juice, sports drinks, tea, coffee). Hot beverages and soups should be provided at the work site as they provide calories and increase morale.*

*For work at or below -12°C (10.4°F), the following should apply:*

- 1. The worker should be under constant protective observation (buddy system or supervision).*
- 2. The work rate should not be so high as to cause heavy sweating that will result in wet clothing; if heavy work must be done, rest periods should be taken in heated shelters and opportunity for changing into dry clothing should be provided.*
- 3. New employees should not be required to work full-time in the cold during the first days of employment until they become accustomed to the working conditions and required protective clothing.*
- 4. The weight and bulkiness of clothing should be included in estimating the required work performance and weights to be lifted by the worker.*
- 5. The work should be arranged in such a way that sitting still or standing still for long periods is minimized. Unprotected, metal chair seats should not be used. The worker should be protected from drafts to the greatest extents possible.*
- 6. The worker should be instructed in safety and health procedures. The training program should include, as a minimum, instruction in:*
  - a. Proper re-warming procedures and appropriate first aid treatment.*
  - b. Proper clothing practices.*
  - c. Proper eating and drinking habits.*
  - d. Recognition of impending frostbite.*
  - e. Recognition of signs and symptoms of impending hypothermia or excessive cooling of the body even when shivering does not occur.*
  - f. Safe work practices."*

*(\*WCT – Wind Chill Temperature)*

**Source: 2022 TLVs and BEIs – Based on the Documentation of the Threshold Limit Values for Chemical Substances and Physical Agents and Biological Exposure Indices. Cincinnati: American Conference of Governmental Industrial Hygienists (ACGIH), 2022-pages 226 – 228, Cold Stress**



**CHANGE LOG**

Section	Version 3.0	Version 3.1
Entire Document		Clerical corrections including spelling, grammar, and document names

<End of Document>



---

# Standard

---

## Fall Protection

---

**Effective Date:** 2019-03-30

**Version #:** 1.4

**Version Date:** 2024-03-27

---



This page intentionally left blank



Document Version Register

Version Number	Version Date	Approved By	Section Number and Title	Details of Version
1.0	2019-03-30	Sean Evans	Whole Document (New Standard)	This is the new H&S standard that was developed as part of the LP   MP Safety Manual Transition Project
1.1	2019-10-31	Sean Evans	4.0	
1.2	2020-06-01	Sean Evans	2.0	Alignment with Contractor Safety Specifications
1.3	2021-12-01	Murray Evenson	9.0,10.0	Updated section 9 to reflect the appropriate review process Updated reference section
1.4	2024-03-27	Troy Croft	All sections	Clerical corrections

Uncontrolled Copy if Printed or Downloaded

Internal Information





This page intentionally left blank



---

## Table of Contents

1.0	Purpose .....	3
2.0	Scope .....	3
3.0	Prerequisites.....	3
4.0	Definitions & Acronyms .....	3
5.0	Roles & Responsibilities.....	4
6.0	Standard-Specific Requirements .....	5
6.1	Fall Protection.....	5
6.1.1	Fall Protection Requirement .....	5
6.1.2	Fall Protection Plan.....	5
6.2	Fall Protection Equipment Requirement.....	6
6.2.1	Anchor Points .....	7
6.2.2	Vertical and Horizontal Lifelines .....	7
6.3	Fall Protection Systems.....	8
6.3.1	Guardrails .....	8
6.3.2	Travel Restraint .....	9
6.3.3	Personal Fall Arrest System .....	9
6.3.4	Safety Nets .....	10
7.0	Training Requirements .....	10
8.0	Related Documents .....	10
9.0	Standard Review .....	10
10.0	References .....	11
11.0	Appendix.....	12
	Rescue Considerations .....	12
	Fall Protection Rescue Plan .....	13
	Change Log.....	14



## 1.0 PURPOSE

The purpose of this standard is to provide the minimum requirements for Enbridge workers and contractors performing work at heights.

## 2.0 SCOPE

This standard applies to LP Operations and to projects being completed for LP.

Contractors and subcontractors shall comply with Enbridge health and safety requirements set out in this standard, as articulated within applicable contractor safety specifications. If a contractor or subcontractor has a health and safety standard or policy materially different from Enbridge's, the contractor/subcontractor shall follow the most stringent requirement. Contractors and subcontractors are still obligated to meet the requirements of all applicable laws related to this standard.

In the event a contractor's or subcontractor's standard exceeds the requirements of this standard, Enbridge may, in its sole discretion, choose to adopt the contractor's or subcontractor's standard for any given contract or work order.

## 3.0 PREREQUISITES

Hazard Assessment, Elimination and Control Standard

Inspection Standard

Safe Work Permit and Work Authorization Standard

## 4.0 DEFINITIONS & ACRONYMS

*Applicable legislation* - All federal, provincial, state and municipal laws, regulations, codes, bylaws, ordinances or otherwise that are applicable to the jurisdiction in which the work is conducted including, but not limited to the Canada Labor Code, OSHA, State OSHA, Provincial and Territorial OH&S.

*Construction work* - means work for construction, alteration, and/or repair, including painting and decorating (OSHA definition).

*General industry* - refers to all industries not included in agriculture, construction or maritime (OSHA definition).

*Maximum arresting force* - is the largest amount of force that the fall protection system and the person attached to the system will experience as generated by the deceleration device.

*Manbasket* - is a personnel platform which is raised, lowered or held in working position by the hoisting line of a crane or hoist, or is attached to a crane boom.

*Qualified* - one who, by possession of a recognized degree, certificate, or professional standing, or who by knowledge, training and experience, has successfully demonstrated their ability to

solve or resolve problems relating to the subject matter, the work, or the project (OSHA definition).

*Self-Retracting Devices (SRD)* - a deceleration device containing a drum-wound line that can be slowly extracted from, or retracted onto, the drum under slight tension during normal employee movement, and which, after onset of a fall, automatically locks the drum and arrests the fall. Once activated, it will stop the action of a fall. (OSHA definition).

*Swing stage and work cages* - a suspension scaffold consisting of a platform supported by hangers (stirrups) suspended by two ropes from overhead supports and equipped with means to permit the raising and lowering of the platform to desired work levels. (OSHA definition).

## **5.0 ROLES & RESPONSIBILITIES**

People leaders shall:

- Ensure that employees, contractors, and subcontractors under their control are aware of and comply with this standard;
- Ensure that all required fall protection equipment resources are readily available;
- Ensure that only qualified workers are designated to develop fall protection plans and to certify horizontal lifelines; and
- Ensure all workers required to work at heights receive fall protection training.

Workers shall:

- Inspect and use fall protection equipment as per manufacturer's specifications;
- Inspect fall protection equipment prior to use;
- Remove damaged and/or impact loaded equipment from service;
- Implement fall protection and rescue plans as required;
- Ensure fall protection training has been completed and is current;

Qualified Worker shall:

- Complete fall protection plan as required by the standard;
- Be appropriately trained and qualified to develop a fall protection plan, and;
- For the use of horizontal lifelines, be appropriately trained and qualified by the manufacturer to certify the horizontal lifeline.

Safety Team shall:

- Provide timely advice, support and assistance to people leaders in the implementation of this standard;
- Perform spot checks on fall protection equipment and fall protection plans to ensure field compliance to the standard; and

Safety Shared Services shall:

- Be responsible for the maintenance and continuous improvement of this standard.

## **6.0 STANDARD-SPECIFIC REQUIREMENTS**

### **6.1 FALL PROTECTION**

Enbridge recognizes working at heights to be a high risk work activity and requires all workers to put the proper controls in place to eliminate or reduce the risk of falls.

#### **6.1.1 FALL PROTECTION REQUIREMENT**

Guardrail systems, safety net systems, personal fall arrest, or travel restraint systems shall be used when Enbridge and/or contractor workers are performing any duties on an unprotected, elevated work surface with a Fall Hazard, which Enbridge defines as:

- 1.2 m (4 ft.) or more above a lower level from a permanent walking/working surface (horizontal and vertical surface) or
- 1.8 m (6 ft.) or more above a lower level from a temporary walking/working surface (includes construction activities) or
- Any fall where there is an unusual possibility of injury (e.g., falling through an opening in a work surface)

#### **6.1.2 FALL PROTECTION PLAN**

A written fall protection plan shall be completed by a qualified worker whenever workers could potentially fall 1.83 m (6 ft.) or more where they are not protected by a guardrail system. The plan shall contain the following:

- Fall hazards at the worksite,
- Fall protection system(s) to be used,
- Anchors to be used,
- Confirmation that clearance distances below the work area are sufficient to prevent a worker from striking the ground or an object or level below the work area,
- Procedures used to assemble, maintain, inspect, use and disassemble the fall protection system, and

- Rescue procedures to be used if a worker falls from a height and is suspended in the air (not required if travel restraint system is being used).

Note: see Appendix for rescue considerations

## **6.2 FALL PROTECTION EQUIPMENT REQUIREMENT**

Fall protection equipment shall meet the requirements of the CSA/ ANSI in Canada and ANSI standards in the US and be maintained and used in accordance with the manufacturing specifications. All components of a fall protection system shall be compatible with one another and with the environment in which they are being used.

Workers shall never be permitted to work alone in a harness when there is a fall potential of 1.83 m (6 ft.) or more.

All fall protection equipment shall be:

- Used only for fall protection purposes,
- Kept free of substances and conditions that would contribute to deterioration,
- Destroyed if it is defective,
- Destroyed if it contacts heat, chemicals or other substances that could cause damage,
- Removed from service and destroyed if subjected to impact loading, and
- Recertified and inspected as specified by the manufacturer and applicable legislation.

Lanyards, self-retracting devices (SRD) and lifelines shall:

- Use softeners when attaching lines to structures (and elsewhere as necessary) and/or where contact with sharp edges are possible,
- Be protected from damage such as abrasion and chafing,
- Be kept free of knots,
- Be used for fall arrest or travel restraint when anchored appropriately, and
- Be compatible with the fall protection equipment being used.

Fall protection connecting hardware, such as carabiners, connectors and snap hooks shall:

- Be self-closing and self-locking,
- Require two deliberate consecutive actions to open, and
- Be marked with the manufacturer's name and the breaking strength.

Note: Sling anchors that do not have connectors can be used with an approved carabiner.

Harnesses used for fall protection shall:

- Only be full body harnesses rated for the employee's weight as per manufacturer's guidelines,
- Be selected for specific applications and consider:
  - Compliance,
  - Potential arrest injury,
  - Suspension trauma, and
- Have buckles that hold securely without slippage or other failure.

### 6.2.1 ANCHOR POINTS

Anchor points shall be capable of withstanding the impact forces applied to them and have a minimum breaking strength of 5000 lb. (22.2 kN); where this cannot be met, use two times the maximum arresting force.

Anchor points come in a wide variety of forms and are usually built to meet the needs of the specific fall protection equipment being used by the worker. This equipment can be connected to a variety of anchorages that are capable of supporting a fall arrest system such as:

- A secured I-beam,
- A concrete column,
- An engineered floor structure, or
- Another device approved by a professional engineer licensed in the applicable province/state.

### 6.2.2 VERTICAL AND HORIZONTAL LIFELINES

#### 6.2.2.1 Horizontal Lifelines

Horizontal lifelines may be flexible or rigid and shall comply with the following:

- Be designed, installed, and used under the supervision of a qualified worker, as part of a complete fall arrest system, which maintains at least two times the maximum arresting force, or travel restraint system,
- Horizontal lifeline systems shall be certified by a professional engineer licensed in the applicable province/ state, the manufacturer, or a qualified worker authorized by either the professional engineer or the manufacturer, and
- Have each worker attached to a separate lifeline unless manufacturer or engineer recommendations allow otherwise.

Approved lifelines may be used for horizontal travel restraint or fall protection.



6.2.2.2 Vertical Lifelines

Vertical lifelines shall:

- Be provided for each worker on swing stages and work cages,
- Be securely anchored to an independent approved structure of adequate strength so that failure of the equipment will not cause failure of the lifeline,
- Meet the strength requirements of applicable legislation, and
- Be long enough to reach the ground.

6.3 **FALL PROTECTION SYSTEMS**

The following flow chart depicts the hierarchy of fall protection that shall be followed whenever working at heights.

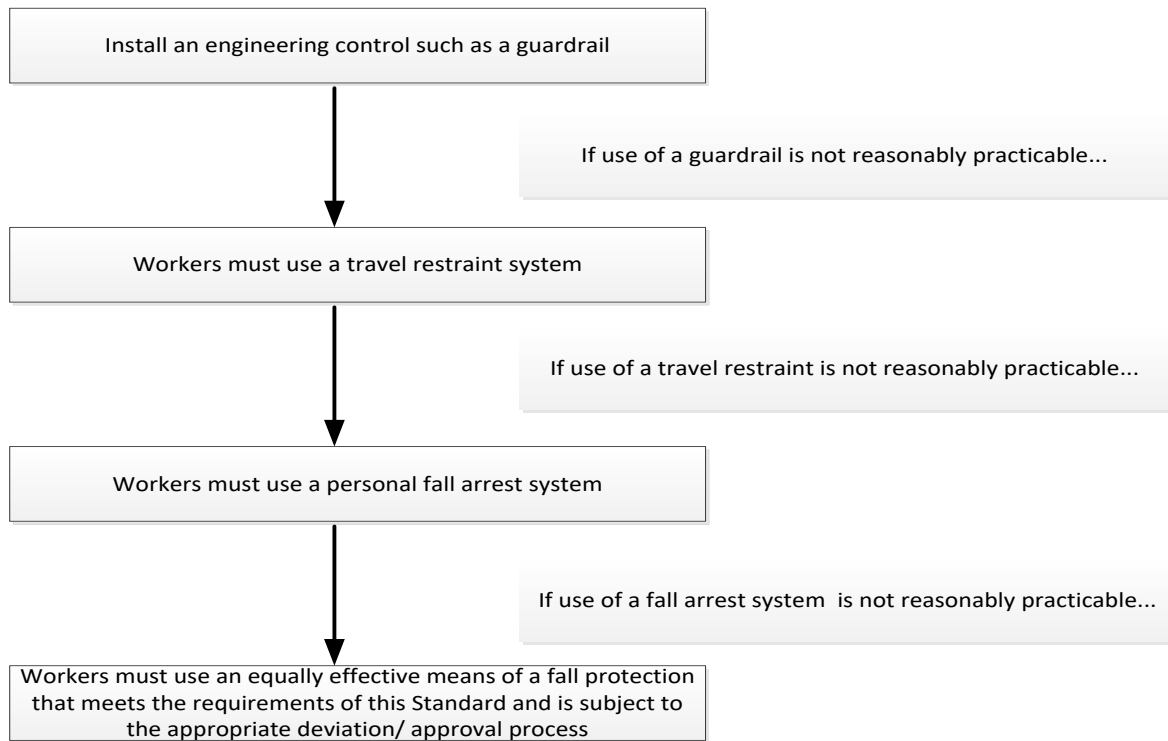

6.3.1 **GUARDRAILS**

Refer to Engineering Design Standard D05-401 for Enbridge-specific requirements

### 6.3.2 TRAVEL RESTRAINT

Travel restraint systems shall:

- Be utilized as a means of preventing workers from reaching the edge or work location in which they could fall,
- Use approved travel restraint anchor points or certified horizontal lifelines,
- Prevent access to the edge at all points when device or rope is fully extended, and
- Be used when working in a manbasket.

### 6.3.3 PERSONAL FALL ARREST SYSTEM

All workers shall wear a personal fall arrest system when:

- It is impractical to provide adequate work platforms, scaffolds, staging and guardrails, and/or
- Working on swing stages and in work cages.

Personal fall arrest systems when stopping a fall shall:

- Limit the maximum arresting force to 1,800 lbs. (8 kN) when using a full body harness as per applicable legislation, which will vary depending on the type of harness and lanyard,
- Not allow a worker to free fall more than 1.83 m (6 ft.) or to contact a lower level with shock absorbing lanyard,
- Not allow a worker to free fall more than 1.2 m (4 ft.) or to contact a lower level without a shock absorbing lanyard,
- Limit maximum deceleration distance to 1.07 m (3.5 ft.), and
- Not allow worker to swing and hit objects.

Lanyards used for fall arrest shall:

- Be secured to an approved lifeline or fixed anchorage point,
- Be secured whenever possible above the waist or overhead to minimize actual fall distance,
  - If not reasonably practicable to attach to an anchor above the level of a workers' waist, the worker must ensure that the clearance and the maximum arresting force requirements are met, and
- Allow for 100 % tie off.

Where practical, the use of a retractable lanyard in place of a basic lanyard system is recommended.

### **6.3.4 SAFETY NETS**

Where safety net protection is required based on a hazard assessment and applicable legislative requirements, work shall not commence until the net is in place and has been tested in accordance with applicable requirements. Prior to using safety nets, contact the safety department for review and assistance.

A professional engineer licensed in the applicable province/ state must certify any structure to which a personnel safety net is attached. The certification must indicate that the structure is capable of withstanding any load the net is likely to impose on it depending on the circumstances of the work site.

Safety nets shall:

- Be installed and maintained so that the maximum deflection under impact load does not allow any part of the net to touch another surface,
- Have safety hooks or shackles of drawn, rolled or forged steel with an ultimate tensile strength of not less than 5000 lbs (22.2 kN),
- Have joints between net panels capable of developing the full strength of the web,
- Extend not less than 2.4 m (7 ft.) beyond the work area, and
- Extend not more than 6 m (18 ft.) below the work area.

## **7.0 TRAINING REQUIREMENTS**

Personnel working in the field must be knowledgeable in this Standard and may be assigned applicable training as driven by the Safety Training Matrix.

Reference the Health & Safety training syllabi and matrices for further information and training re-certification requirements.

## **8.0 RELATED DOCUMENTS**

Fall Protection Plan Template

Fall Rescue Plan Template

Mobile Equipment Standard

Tools and Equipment Standard

## **9.0 STANDARD REVIEW**

A subject matter expert (SME) will perform a technical review of this standard every two years to determine the accuracy of the content/information. The SME shall solicit input from applicable stakeholders to ensure the effectiveness of the standard. Any suggested changes must be reviewed and approved by the designated document owner.

---

## 10.0 REFERENCES

ANSI Z359.1 (2016) – The Fall Protection Code

CAN/CSA-Z259.10-12 (R2016) - Full body harnesses

Canada Labour Code, Part II:

Canadian Occupational Safety & Health (COSH) regulations

- 12.06 Protection Equipment and Other Preventive Measures - Fall Protection - Fall Protection Plan
- 12.07 – 12.08 Protection Equipment and Other Preventive Measures - Fall Protection - Fall Protection Systems
- 12.09 Protection Equipment and Other Preventive Measures - Protection Equipment and Procedures - Fall Protection

Occupational Safety and Health Administration (OSHA)

- Personal Fall Protection Systems, 29 CFR 1910.140
- Duty To Have Fall Protection, 29 CFR 1910
- Fall protection systems & falling object protection - criteria and practices, 29 CFR 1910.29

---

## 11.0 APPENDIX

### RESCUE CONSIDERATIONS

When a worker is suspended from a height while using a fall arrest system, it can result in serious physical injury, or potentially death in less than 30 minutes.

To reduce the risks associated with short or long periods of suspension, the following should be considered when determining rescue procedures as part of the fall protection plan:

- List of required resources should a fall occur (workers and associated qualifications related to rescue, specific equipment, external parties),
- Specific factors that may hinder a rescue (location, access to suspended worker etc.) and how those factors will be mitigated,
- Rescue any suspended workers as quickly as possible, orthostatic intolerance can occur within 3 minutes of suspension,
- Be aware that a suspended worker is at risk of orthostatic intolerance and suspension trauma,
- Be aware of signs and symptoms of orthostatic intolerance (light-headedness, dizziness, fatigue, blurred vision),
- Be aware that a suspended worker who is unconscious or has a head injury is particularly at risk of orthostatic intolerance,
- Be aware of factors that can increase the risk of suspension trauma,
- If practical, have a medical professional present when moving a worker to a horizontal position following suspension,
- Use of rescue stirrups to allow suspended workers to maintain blood flow, and
- Rope/cable tenders shall make certain the harness user is conscious at all times.



FALL PROTECTION RESCUE PLAN



Fall Protection Rescue Plan

Date:	Work Location(s)/ Area(s):
Rescue Procedures:	
	
Sketch of Area for Rescue	
	

\*Must be attached to a Fall Protection Plan to be valid



---

**CHANGE LOG**

<b>Section</b>	<b>Version 1.3</b>	<b>Version 1.4</b>
Entire document		Clerical corrections including spelling, grammar, and document names.

<End of Document>



---

# Standard

---

## Fatigue Management

---

**Effective Date:** 2019-03-30

**Version #:** 1.4

**Version Date:** 2024-03-28

---





This page intentionally left blank





This page intentionally left blank

---

## Table of Contents

1.0 Purpose .....	3
2.0 Scope .....	3
3.0 Prerequisites.....	3
4.0 Definitions & Acronyms .....	3
5.0 Roles & Responsibilities.....	4
6.0 Standard-Specific Requirements .....	5
6.1 People Leader Expectations.....	5
6.2 Individual Fatigue Assessment Tool.....	5
6.3 Fatigue Mitigation Plan .....	6
7.0 Training Requirements .....	7
8.0 Related Documents.....	7
9.0 Standard Review .....	7
10.0 References .....	7
11.0 Appendix.....	8
11.1 Individual Fatigue Assessment Template.....	8
11.2 Example of How the Individual Fatigue Assessment Tool Works.....	9
11.3 Fatigue Mitigation Plan Template .....	11
11.4 Fatigue Management Best Practices – Additional Information .....	12
11.4.1 Fatigue Prevention Best Practices .....	13
11.4.2 Fatigue Mitigation Countermeasures.....	13
11.4.3 Fatigue Considerations for Drivers .....	14
11.4.4 Fatigue Considerations for People Leaders .....	15
11.4.5 Fatigue Considerations for Event Analyses.....	15
11.4.6 Body Clocks (Circadian Rhythm).....	15
11.4.7 The Importance of Sleep .....	17
11.4.8 Nutrition.....	18
11.4.9 Active Living.....	19

**Uncontrolled Copy if Printed or Downloaded**



---

Change Log..... 21

## 1.0 PURPOSE

The purpose of the Fatigue Management Standard is to ensure that all People Leaders and employees understand what fatigue is, how to recognize it and provide appropriate mitigations in order to minimize its impact at Enbridge.

## 2.0 SCOPE

This standard applies to LP Operations and Projects being completed for LP.

The Control Center Operations (CCO) Shift Working Staff is out of scope for this standard and will refer to the Control Centre Operations Fatigue Risk Management Handbook and Control Room Management Plan. The CCO Day Working Support Staff would be within scope for this standard.

Contractors and subcontractors shall comply with Enbridge health and safety requirements set out in this standard, as articulated within applicable contractor safety specifications. If a contractor or subcontractor has a health and safety standard or policy materially different from Enbridge's, the contractor/subcontractor shall follow the most stringent requirement. Contractors and subcontractors are still obligated to meet the requirements of all applicable laws related to this standard.

In the event a contractor's or subcontractor's standard exceeds the requirements of this standard, Enbridge may, in its sole discretion, choose to adopt the contractor's or subcontractor's standard for any given contract or work order.

## 3.0 PREREQUISITES

Hazard Assessment, Elimination and Control Standard

Safe Work Permit and Work Authorization Standard

LP Canadian Operations Hours of Work Guidelines

## 4.0 DEFINITIONS & ACRONYMS

*Fatigue* - A state of reduced mental and physical alertness or functioning caused by sleep-related disruption or deprivation. Fatigue is a feeling of tiredness or exhaustion that comes from physical or mental exertion. It is a message to the body to rest. Fatigue can be aggravated by acute lack of sleep or an accumulated sleep debt.

*Fatigue Mitigation Plan* – A plan for addressing fatigue at the worksite or the office for LP Operations and to projects being completed for LP

*Fitness for duty* - Fitness for duty means that an individual is in a physical, mental, and emotional state which enables the employee to perform the essential tasks of his or her work assignment in a manner which does not threaten the safety or health of his or herself, co-workers, property, or the public at large.

*Micro sleeps* - A state of up to 60 seconds where the brain goes to sleep and the worker blacks out no matter what they are doing.

*NREM* – Non-rapid eye movement sleep

*Optimum Scheduling* - Schedules that align to normal human sleep patterns and social compatibility, in addition to operational efficiency and effectiveness.

*RAVS* - Review and Verification Service, a service ISNetwork performs a variety of related to contractor and supplier data.

*REM* – Rapid eye movement sleep

*Simple or Monotonous Tasks* - Routine tasks lasting half an hour or more.

*Sleep Debt* - The state of chronic fatigue and sleepiness that results from the lack of sufficient sleep or disrupted sleep.

## **5.0 ROLES & RESPONSIBILITIES**

People Leader shall:

- Ensure that employees under their control are aware of and comply with this Standard;
- Ensure that work schedules comply with all applicable standards and procedures;
- Monitor personnel for the signs and symptoms of fatigue;
- Complete or ensure the completion individual fatigue assessments and fatigue mitigation plans as directed by Standard;
- Approve controls for managing fatigue where required;
- When performing event analyses, confirm if fatigue was a contributing factor to the event and assign mitigation as appropriate, including potential improvement opportunities within this Standard.

Workers shall:

- Be fit for duty at the commencement of and during the work shift;
- Communicate personnel fatigue concerns to their People Leader;
- Comply with this Standard;
- Report all self-assessment tool scores of 5 or greater to People Leader;
- Monitor for signs and symptoms of fatigue within their co-workers;
- Support and participate in risk mitigation activities; as required; and
- Stop work when the activities are unsafe due to fatigue.

Safety Team shall:

- Provide timely advice, support and assistance to People Leaders in the implementation of this Standard;

**Uncontrolled Copy if Printed or Downloaded**

- Conduct an effectiveness review of the fatigue management control measures implemented; as required; and
- Ensure that fatigue is considered during event analyses.

Safety Shared Services shall:

- Be responsible for the maintenance and continuous improvement of this standard.

## **6.0 STANDARD-SPECIFIC REQUIREMENTS**

### **6.1 PEOPLE LEADER EXPECTATIONS**

People Leaders are accountable for the safe and reliable execution of work at Enbridge. This includes recognizing and mitigating the risk of fatigue within their workforce.

People Leaders will often need to rely on their subjective judgement to assess if an employee(s) is suffering from impairment due to fatigue. This includes performing informal 'fit for duty' assessments during interactions with their reports. If an employee is displaying symptoms of fatigue such as:

- red eyes
- subdued responsiveness
- excessive yawning
- micro sleeps / head bobbing
- quiet and withdrawn
- eye rubbing

The People Leader should have a private conversation with the individual and ask open ended questions in order to understand if fatigue is a concern and if further action is required. The People Leader may choose to complete an Individual Fatigue Assessment with the worker to assist with their fatigue level determination. This formal assessment process is not a Standard requirement but a supplemental tool that People Leaders may utilize when determining if fatigue is an issue.

People Leaders will not always be available to assess their workers for fatigue. Employees are also responsible for monitoring their co-workers and themselves for fatigue levels that may cause a safety concern and can address it through the safety observation process or addressing it directly with their People Leader.

### **6.2 INDIVIDUAL FATIGUE ASSESSMENT TOOL**

The Individual Fatigue Assessment tool is a method to quantitatively determine if a Fatigue Mitigation Plan is required for an employee due to sleep deprivation. There are two scenarios where an Individual Fatigue Assessment could be potentially utilized:



- 1) A worker self-diagnoses significant fatigue and completes the Individual Fatigue Assessment. If a score of 5 or greater is attained, the People Leader is notified so either additional monitoring can be implemented or a Fatigue Mitigation Plan can be developed.
- 2) A People Leader notices a worker displaying symptoms of fatigue and requests that together they complete the Individual Fatigue Assessment. If a score of 9 or greater is attained then a Fatigue Mitigation Plan is implemented.

An example of how the Individual Fatigue Assessment tool works can be found in the Appendix. An individual fatigue assessment which scores 9 or greater would require a fatigue mitigation plan.

### **6.3 FATIGUE MITIGATION PLAN**

A fatigue mitigation plan is a written document that highlights the fatigue related risk associated with the upcoming work, details of the impact the risk potentially could have at the worksite, describes what controls will be implemented to effectively manage the risk and who is responsible for implementation. A fatigue mitigation plan is required when:

- An employee self-reports that he or she is not fit for duty, or
- When a People Leader deems that an employee is not fit for duty, or
- A score of 9 or greater on the Individual Fatigue Assessment tool, or
- Extended workday including travel time to and from the worksite that exceeds 14 consecutive hours, or
- Evenings where a worker who is on-call has received more than one call-out that evening or will be awake for 17 consecutive hours or greater.

There are a number of different options for how a fatigue mitigation plan can be developed and executed. These include the following:

- 1) Utilizing the Field Level Hazard Assessment (FLHA) process, or
- 2) A regional-specific fatigue mitigation plan developed for employees who are on an on-call rotation that provides pre-determined proactive direction on how employees can manage fatigue risk during extended callout scenarios, or
- 3) Verbal agreement between a People Leader and employee that is documented (i.e. personal day timer, FLHA, etc.), or
- 4) Fatigue mitigations detailed within a Project Safety Plan or Safe Work Permit, or
- 5) Utilization of the Fatigue Mitigation Plan Template for the day/circumstances in question or for the length of the project or activity where worker fatigue is a significant concern.

The Fatigue Mitigation Plan Template can typically be utilized for events such as outages or prolonged emergency response activities where extended worker hours will require fatigue mitigation practices. In these types of circumstances, the Fatigue Mitigation Plan template is

developed by the People Leader in collaboration with employees who will be engaging in the work. Once the People Leader and the affected employees have agreed upon the fatigue risks involved along with the appropriate mitigations, the plan is signed off by all parties and implemented accordingly.

Regardless on which option is used to develop the fatigue mitigation plan, examples of potential fatigue mitigations can be found in the Appendix of this Standard.

## **7.0 TRAINING REQUIREMENTS**

Personnel working in the field must be knowledgeable in this Standard and may be assigned applicable training as driven by the Safety Training Matrix.

Reference the Health & Safety training syllabi and matrices for further information and training re-certification requirements.

Control Center Operations personnel will complete fatigue training assignments as currently assigned within Workday Learning.

## **8.0 RELATED DOCUMENTS**

Individual Fatigue Assessment Template

Fatigue Mitigation Plan Template

## **9.0 STANDARD REVIEW**

A subject matter expert (SME) will perform a technical review of this standard every two years to determine the accuracy of the content/information. The SME shall solicit input from applicable stakeholders to ensure the effectiveness of the standard. Any suggested changes must be reviewed and approved by the designated document owner.

## **10.0 REFERENCES**

Occupational Safety and Health Administration (OSHA) Act

- Section 5, Duties

Canada Labour Code, Part II:

- Canadian Occupational Health & Safety Regulations, Hazard Prevention Program; Part XIX

## 11.0 APPENDIX

### 11.1 INDIVIDUAL FATIGUE ASSESSMENT TEMPLATE



**Individual Fatigue Assessment Form**

ENB-FRM-0032

<b>Step 1:</b> Sleep in Prior 24 hours (select one) :					Score
Points:	≤2 hours 12	3 hours 8	4 hours 4	≥5 hours 0	
<b>Step 2: Sleep in prior 48 hours</b> (total hours slept in the past 48 hours) (select one):					
Points:	≤8 hours 8	9 hours 6	10 hours 4	11 hours 2	12 hours 0
<b>Step 3:</b> <b>Prior awake</b> Count the total hours the worker will have been awake at the end of their shift. For every hour more than sleep at the end of the prior 48 hours, add one point.					
<b>Total Points</b>					

<b>Step 4: Use Total Points to determine your Score and Control Level</b>	
Score	Control Level
1-4	Self-Monitoring
5-8	People Leader monitoring
9+	People Leader implements Fatigue Management Plan

## 11.2 EXAMPLE OF HOW THE INDIVIDUAL FATIGUE ASSESSMENT TOOL WORKS

Fitness for duty can be determined by a formula that is comprised of three simple calculations:

- (1) Continuous sleep in the prior 24 hours
- (2) Continuous sleep in the prior 48 hours
- (3) Total time awake from when worker work up this morning to the end of their shift.

By entering the information provided by the employee into the Individual Fatigue Assessment tool, a People Leader can assess what level of fatigue countermeasures are required.

<b>Step 1:</b> <b>Sleep in Prior 24 hours</b> (select one) :	Score
Points:    ≤2 hours    3 hours <b>4 hours</b> ≥5 hours 12            8            4            0	4
<b>Step 2: Sleep in prior 48 hours</b> (total hours slept in the past 48 hours) (select one):	
Points:    ≤8 hours    9 hours    10 hours <b>11 hours</b> ≥12 hours 8            6            4            2            0	2
<b>Step 3:</b> <b>Prior awake</b> Count the total hours the worker will have been awake at the end of their shift. For every hour more than sleep attained in the prior 48 hours, add one point.	
<b>Total Points</b>	9

*How much sleep did the employee have in the last 24 hours?*

*How much sleep did the employee have in the last 48 hours?*

*Count the total hours the employee has been awake at the end of their shift. For every hour more than the hours the employee slept in the past 48 hours, add one point.*

Step 4: Use Total Points to determine your Score and Control Level	
Score	Control Level
1-4	Self-Monitoring
5-8	People Leader monitoring
<b>9+</b>	<b>People Leader implements Fatigue Management Plan</b>

*Add all points together to determine the employee's fatigue level score and implement countermeasures as appropriate.*

Figure 1 shows what a properly completed form would look like.

- Employee slept 4 hours in prior 24 hours. Picked up 4 points.
- Employee slept 11 hours in the prior 48 hours. Picked up 2 points. (Slept 4 hours last night and 7 hours the night before)
- Count the total hours the employee has been awake at the end of current shift. The employee, by the end of the shift, would be up 14 hours. Add one point for every hour more than sleep attained in the prior 48 hours. The employee has been up 14 hours and has slept 11 hours in the last 48 hours. Equals a score of 3 points.
- Add up your total points which total 9. A formal fatigue mitigation plan is required.

---

The numbering system within the Individual Fatigue Assessment Tool was based on an algorithm developed by Queensland Health, Australia. Transport Canada has adapted their same format for their fatigue assessment process.

### 11.3 FATIGUE MITIGATION PLAN TEMPLATE



#### Fatigue Mitigation Plan

<b>Region/ Project:</b> Click here to enter text.		<b>Time Period Fatigue Mitigation Plan in Effect:</b> YY-MM-DD to YY-MM-DD Click here to enter text.	
<b>People Leader:</b> Click here to enter text.		<b>Employee Name(s) involved in Work:</b> Click here to enter text.	
<b>Reasoning for Fatigue Mitigation Plan</b> (check all that apply): <input type="checkbox"/> An Employee self-reports that he/she is not fit for duty <input type="checkbox"/> When a People Leader deems that an Employee is not fit for duty <input type="checkbox"/> A score of 9 or > on the Individual Fatigue Assessment Tool <input type="checkbox"/> Extended work day including travel time to and from the worksite that exceeds 14 consecutive hours <input type="checkbox"/> Evenings where a Worker who is on-call has received more than one call-out that evening or will be awake for 17 consecutive hours or greater <input type="checkbox"/> Outage, ER Response or other extended work activity			
Fatigue Risk	Impact	Planned Control	Responsibility
Click here to enter text.	Click here to enter text.	Click here to enter text.	Click here to enter text.
Click here to enter text.	Click here to enter text.	Click here to enter text.	Click here to enter text.
Click here to enter text.	Click here to enter text.	Click here to enter text.	Click here to enter text.
Click here to enter text.	Click here to enter text.	Click here to enter text.	Click here to enter text.
Click here to enter text.	Click here to enter text.	Click here to enter text.	Click here to enter text.
Click here to enter text.	Click here to enter text.	Click here to enter text.	Click here to enter text.

\_\_\_\_\_  
Affected Employee(s) Signature(s)

\_\_\_\_\_  
Affected Employee(s) Signature(s)

\_\_\_\_\_  
Affected Employee(s) Signature(s)

\_\_\_\_\_  
Affected Employee(s) Signature(s)

\_\_\_\_\_  
Affected Employee(s) Signature(s)

\_\_\_\_\_  
Affected Employee(s) Signature(s)

\_\_\_\_\_  
People Leader Signature

Uncontrolled Copy if Printed or Downloaded

**11.4 FATIGUE MANAGEMENT BEST PRACTICES – ADDITIONAL INFORMATION**

Fatigue Impacts and Consequences

Fatigue has a significant influence on health and safety both at work and at home. Fatigue causes slower reaction times and can result in poor decisions, more mistakes, decreased performance, and dangerous memory lapses. When examining work and fatigue, research demonstrates that the probability of a workplace event rises with a decrease in alertness. Findings from research confirm that:

- The highest rate of industrial events is usually found among shift workers and are most likely to occur at times when workers are most prone to sleep.
- On the roads, more vehicle collisions occur in the early morning hours than at other times. Drivers in fatigue-related events had an average of five and a half hours during their last sleep period and evidence shows that the one hour lost in the switch to daylight savings time increases collision rates by seven percent (NTSB, 1995).
- Findings suggest that after only 20 hours of sustained wakefulness, a person may be as impaired as someone with a blood alcohol concentration of 0.10 percent. (Lamond & Dawson, 1999)

There are many variables that can impact the level of fatigue within an individual or a work team. Examples include:

<b>Variables Impacting Fatigue</b>		
Time of Day	Availability of food and water	Working Alone
Temperature	Lifestyle Choices	Corporate Culture
Repetitive Functions	Type of Work	PPE
Stress	Length / Frequency of Breaks	Shift Duration

Consequences of fatigue result in reduced response time and overall cognitive impairment of a worker. Other examples include:

<b>Consequences of Fatigue</b>		
Decreased Alertness	Inadequate Performance	Slow Reaction Time
Reduced Motivation	High Rate of Error	Impaired Judgement
Failure to Respond	Poor Decision Making	Ineffective Communication
Reduced Short-Term Memory	Micro-Sleeps	Increased Risk Tolerance

### 11.4.1 FATIGUE PREVENTION BEST PRACTICES

People Leaders and employees must have a strong understanding of the science behind fatigue in order to effectively management it. This understanding and awareness will support worksite recognition and the implementation of effective mitigations that will minimize the negative impacts to workers and the organization. For more information on managing sleep cycles, sleep disorders, proper nutrition and active living refer to the Appendix of this standard.

### 11.4.2 FATIGUE MITIGATION COUNTERMEASURES

People leaders and employees can implement many different types of countermeasures to successfully mitigate fatigue in the workplace. These opportunities can be segregated into individual and team-based controls. For addressing individual fatigue, potential mitigation alternatives include:

Fatigue recognition awareness within crew Toolbox Talks	Increase social interaction	Transport home
Ensure adequate hydration and food intake	Complete higher risked tasks earlier in the shift	Use the buddy system
Take short and frequent breaks	High intensity task rotation within crew	Temperature control
Power nap or quiet time	Increased physical activity when required	Lower risk task assignment
Length and timing of shifts	Identify health problems which may affect an employee's ability to work extended hours	Adequate lighting for work space

The above examples are also suitable for managing fatigue risk within a work team or crew. Other examples that can also be used by a People Leader to mitigate fatigue risk for their team include:

Inform and educate all workers about the Fatigue Management Standard including contractors' personnel	Solicit additional resources to help minimize extended hours	Communicate team fatigue status and mitigation control effectiveness during toolbox talk
Minimize extended hours of work when possible	Defer non-urgent work	Give as much advanced notice of extended hours and a minimum of 24 hours' notice if shift changes
Recognize individual and crew fatigue, and encourage workers to look out for each other (increase cross-checking)	Increase supervision	Designated driver for crew
Shift fatigue assessments	Group physical activity (for sedentary work)	Increase safety observations



### 11.4.3 FATIGUE CONSIDERATIONS FOR DRIVERS

Any factor that affects a driver’s ability to safely operate a motor vehicle is impairment. These factors include physical (fatigue), psychological (personal problems/aggressiveness), or chemical (alcohol or drugs) resulting in delayed response time, weakening physical coordination, and reduced attention span.

There are several indicators that an employee or People Leader can recognize that indicates that a driver may be or becoming fatigued and mitigation action is required:

Trouble keeping eyes open/head up	Missing a gear or braking too late	Frequent yawning, nodding off
Failure to check mirrors	Difficulty maintaining a constant speed	Failure to dim high-beams at night
Disconnected or wandering thoughts	Drifting in and out of sleep	Difficulty in remembering the last few kilometers
Hallucinations/daydreaming	Missing an exit or road sign	Red eyes and constant blinking
Driving long distances without rest breaks	Driving through the night or the early afternoon	Working shifts or extended hours

Best practices to manage fatigue for workers who drive on a regular basis include:

*Pay attention to your body clock:* Regardless of hours worked or sleep attained, during the hours of 2 a.m. to 5 a.m. and again from 2 p.m. to 4 p.m., biological clocks are programmed towards sleep. Plan driving itineraries by factoring in circadian (body clock) “low points” potentially avoiding driving at these times of day.

*Get the amount of sleep you need to be effective at work the next day:* The average person needs 7 to 8 hours of sleep to feel fully refreshed.

*Journey management:* Plan trips carefully, including where and when to stop for food, sleep and rest and active movement breaks. Planning and having enough time are the keys to safe driving.

*Recognize drowsiness:* Realize the signs of sleepiness and mitigate immediately. Pull over to a safe place to rest or power nap. Do not drive for more than four hours straight. Two hour driving stretches are recommended. Napping is one of the most effective countermeasures to sleep deprivation. Naps should be between 20 and 30 minutes in duration.

*Follow driving best practices:* Perform a few physical exercises when the vehicle is stopped. Keep temperatures within vehicle at a comfortable level remembering that heat contributes to drowsiness. Drink water as often as possible—six to eight glasses a day. Stay mentally alert: listen to music, mentally calculate distances. Start your work shift with zero sleep debt.

### 11.4.4 FATIGUE CONSIDERATIONS FOR PEOPLE LEADERS

An additional tool for successfully managing fatigue within normal operations or an emergency situation is appropriate shift scheduling. For information on this process, reference the LP Canadian Operations Hours of Work Policy.

### 11.4.5 FATIGUE CONSIDERATIONS FOR EVENT ANALYSES

Fatigue can be a significant contributing factor to events or near misses within the workplace. Analysis leads should be cognizant of this potential and ensure that their analyses review the following elements:

- When did the worker last sleep?
- How long did the worker sleep the last time?
- Did the worker have a restful sleep?
- What was the time of shift?
- How many consecutive hours had the worker worked?
- What and when was the worker's last break between shifts?
- How many days did the worker work in a row?
- How many hours did the worker work on those days?
- Are there any other human factors that may have affected the worker's fatigue level?

Answering these questions will provide the event analysis team the knowledge required to determine if fatigue was a contributing factor within the event. Corrective actions can then be implemented to ensure the event does not reoccur.

### 11.4.6 BODY CLOCKS (CIRCADIAN RHYTHM)

All employees possess a biological clock that works on an approximately 24-hour cycle. It is called the circadian rhythm, meaning daily rhythm. This body clock is situated in the brain and controls sleep cycle, affects hormonal levels, digestion, body temperature, and ability to think. During the day, as the body temperature rises, waking up occurs, levels of cortisol (a hormone which helps maintain wakefulness) increases while production of growth

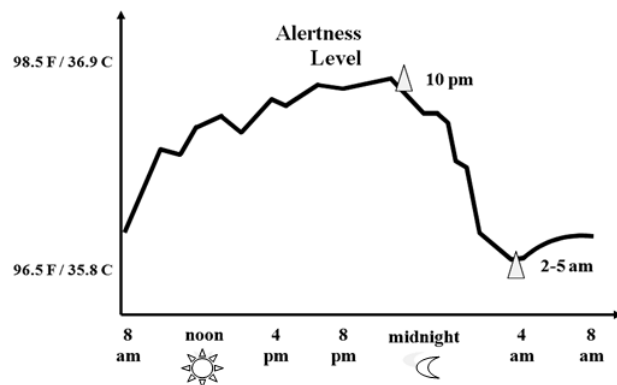

hormone (for restoring tissue) goes down. The greatest influence on fatigue within the body is the rise and fall of actual body temperature during the course of a day. When the temperature goes down this creates a powerful physiological desire to sleep. Body temperature begins to rise just before wake-up time. Throughout the day temperature rises till about 2:00 p.m. and as a result workers function at peak efficiency. They are most alert, digestion is working, and physical strength is at a high. Between 2:00 and 4:00 p.m. core body temperature takes a sharp drop. This “post-lunch dip” is accompanied by a drop in alertness, and increased fatigue. Following this drop, the body temperature rises again, reaching peak efficiency in the late afternoon and early evening. Later as the core temperature begins to drop, the body begins to slow down around 9:00 p.m. There is a critical time between 2:00 and 5:00 a.m. when our circadian rhythms program us to sleep. A number of fatigue-related collisions increase significantly at 2:00 p.m. and 2:00 a.m. Natural body rhythms make workers less attentive in the middle of the afternoon and after 9:00 p.m. These times of decreased alertness can limit on-the-job performance and increase the risk of an accident.

There are several best practices that a worker can follow to minimize this risk by:

- ✓ Start the morning with a good breakfast. Have a snack 2 or 3 hours later that morning to stabilize blood sugar level.
- ✓ Keep lunches to a reasonable size. A large meal increases the urge to sleep.
- ✓ Make sure your breakfast and lunch contain protein, carbohydrates and good fats. Avoid high fat lunches. Limit food that has high amounts of saturated or hydrogenated fats.
- ✓ Avoid foods high in sugar since sugar can lead to blood sugar spikes that result in a powerful insulin response.
- ✓ Hydration. Have a glass or two of cold water.
- ✓ Make it a habit to schedule tasks requiring precise concentration outside of 2:00 p.m to 4:00 p.m.
- ✓ Go for a brisk walk, get fresh air, get natural light at this time, or have a brief stretching routine.
- ✓ Where appropriate, take a 15 to 20 minute power nap. A power nap can return two hours of high productivity.
- ✓ Incorporate aerobic exercise within your work routine during times of drowsiness or tiredness.

### 11.4.7 THE IMPORTANCE OF SLEEP

Sleep is an important life function as the average person needs about 7 - 8 hours of sleep a day. There are two kinds of sleep: REM sleep (dreaming sleep) and non-REM (orthodox sleep). REM stands for rapid eye movement because

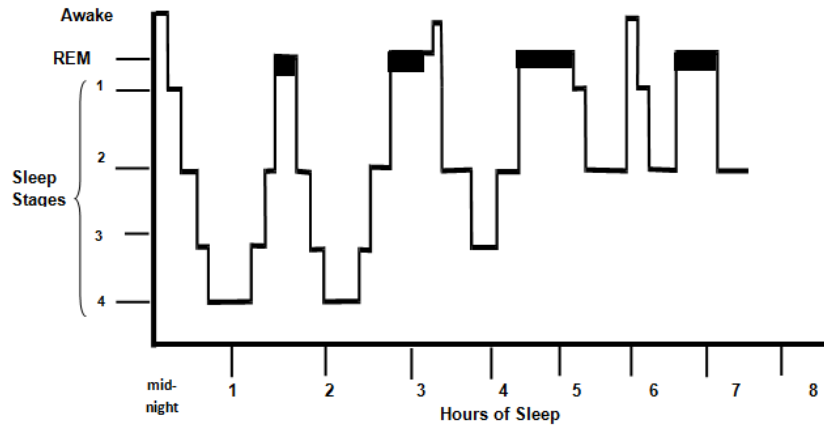

our eyes move rapidly during that stage. Non-REM sleep comes in two variations: the light type of sleep called Stages 1 and 2, and the much deeper version called delta sleep (or Stages 3 and 4). Going to sleep is like going down an escalator. Stage 1 is followed by Stage 2, then into deep sleep in Stages 3 and 4. The sleep cycle is completed with a period of REM (dreaming sleep). A full cycle of sleep takes about 90 minutes and there are about 5 or 6 sleep cycles per night. If these stages are interrupted, then a worker is at a higher risk for fatigue at the worksite for their upcoming shift.

Best practices that a worker can utilize to ensure a good night sleep are:

- ✓ Get an adequate amount of sleep every night. Identify the amount of sleep required to be fully alert all day long and get that amount every night.
- ✓ Get uninterrupted sleep. For sleep to be rejuvenating, it should be attained within one continuous block.
- ✓ Stick to the same schedule. Try to wake up and go to bed at the same time each day.
- ✓ After finishing a hard day at work, it is really important to wind down. Build in time during the evening to relax and recover. If there are things on your mind, set aside time before or after supper to worry about them. Don't discuss or think about stressful things just before you go to sleep.
- ✓ Develop a regular bedtime routine. Develop routines to practice before you go to sleep. Have a shower or hot bath and bring light reading material such as a favorite magazine.
- ✓ Make up for lost sleep as soon as possible. To catch up, go to bed earlier.
- ✓ Keep your bedroom dark and quiet. Sleep on a good bed.
- ✓ A somewhat cool 19 to 20 degrees Celsius (66-68°F) room also contributes to a better sleep.

Uncontrolled Copy if Printed or Downloaded

- ✓ Aerobic exercise increases deep sleep, but don't do it close to bedtime.
- ✓ Reduce caffeine intake for six hours before going to bed.
- ✓ Avoid alcohol near bedtime. Both NREM (deep, restorative) and REM (active dreaming) sleep will be suppressed, and early-morning awakening will be experienced if alcohol is consumed within two hours of bedtime.

One factor workers often overlook when they sleep poorly is the possibility of a sleep disorder. These range from insomnia to sleep apnea, restless leg syndrome, advanced and delayed sleep phase.

*Insomnia* is a persistent disorder that can make it hard to fall asleep, hard to stay asleep or both, despite the opportunity for adequate sleep. Insomnia is a symptom of an overactive arousal system (having trouble going to sleep) or an underactive sleep system (sleep system isn't working properly to put and keep you asleep).

*Sleep apnea* is a serious, potentially life-threatening sleep disorder in which breathing is briefly and repeatedly interrupted during sleep. The "apnea" in sleep apnea refers to a breathing pause that lasts at least ten seconds. Obstructive sleep apnea occurs when the muscles in the back of the throat fail to keep the airway open, despite efforts to breathe.

*Restless Legs Syndrome* is characterized by tingling, crawling, or restless sensations in the legs, which prevents falling asleep.

*Delayed/Advanced Sleep Syndrome* is a condition resulting from a mismatch between the body clock and scheduled time. People with delayed sleep phase feel sleepy later at night, and those with advanced sleep phase feel sleepy early in the evening.

If you believe you may have any of these sleep disorders, it is highly recommended to get treatment from a professional. Most sleep disorders can be effectively treated.

#### 11.4.8 NUTRITION

A "well-balanced diet" contains food from all four food groups including vegetables, fruit, grain products, milk products and meat. Each food group provides a unique set of nutrients. Meals containing all four food groups are more likely to obtain the majority of nutrients required for a healthy adult to minimize the risk of fatigue onset. Three principles to remember during meal times are:

- 1) The majority of your plate should be covered with choices from the fruits & vegetables group and the grains group.
- 2) Limit the size of your meat portions to 3 – 4 oz. (about the size of a deck of playing cards).
- 3) Choose carbohydrate and protein foods at each meal to keep appetite in check for 3 to 4 hours and keep the added fats to a minimum.

Because of the nature of worker schedules, eating at regular times and having properly prepared food may be challenging. Utilize the best practices below to assist with achieving proper nutrition and minimize the effects of fatigue at work and home:

- ✓ Choose easy to digest foods such as fish, lean meats, skinless chicken, rice, vegetables, soybeans, tofu, fruits, whole grain breads, and cereals, and low-fat milk or cheese products.
- ✓ Cut down on heavy, saturated fat found in foods such as fatty meats, pastries, pizza, potato chips, rich dairy products, sausages, pork and fried foods.
- ✓ For extra energy eat more protein. Protein contains the amino acid, tyrosine, which converts to the alertness neurotransmitters norepinephrine and dopamine. Proteins include: lean meats, skinless chicken, fish, soybeans, and low fat milk or cheese products. Meat and alternatives should be 3 to 4 ounces for lunch and supper, for a total of 6 to 8 ounces per day (2 decks of cards).
- ✓ To induce sleep and calm nerves eat some carbohydrates prior to going to sleep. Carbohydrates assist the amino acid, tryptophan, which converts to the calming neurotransmitter serotonin. Carbohydrates include: corn flakes cereal, bread, mashed potatoes, waffles, fruit, granola, and macaroni and other pastas.
- ✓ Add fiber to your diet with plenty of vegetables, cereals, and whole grain breads
- ✓ Try to follow a regular three meal a day pattern. Have at least one hot meal a day. Improve your meals with snacks every two to three hours (grazing versus gorging).
- ✓ Drink 6 to 8 glasses of water a day
- ✓ Avoid food and beverages containing caffeine (e.g. coffee, pop) within 4 hours of bedtime.

### 11.4.9 ACTIVE LIVING

Regular physical activity will improve sleep, increase alertness and minimize the effects of fatigue. Unfortunately, work schedules can make it difficult to schedule regular exercise. Ideally employees should strive for 30 minutes or greater of physical activity each week. Activity time can be accumulated throughout the day in five- or ten-minute intervals. In fact, ten minutes of reasonable physical activity (walking) in three separate intervals produces the same health benefits as 30 minutes of continuous physical activity. So, having a brief 10-minute walk



Figure 4 Nadon Consulting 2010

Uncontrolled Copy if Printed or Downloaded

---

during two or three scheduled rest breaks does add up. Achieving the Fitness Pyramid details on a weekly basis will provide significant health and fitness benefits as well as mitigate the fatigue impacts at home and the worksite.



---

## CHANGE LOG

Section	Version 1.3	Version 1.4
All sections		Clerical corrections including spelling, grammar, and document names.
5.0, 11.4, 11.4.5		Updated terminology from incident and investigation to event and analysis.

<End of Document>





---

# Standard

---

## Field Ergonomics

---

**Effective Date:** 2019-03-30

**Version #:** 1.3

**Version Date:** 2024-03-27

---



This page intentionally left blank





---

This page intentionally left blank

---

## **Table of Contents**

1.0 Purpose .....	2
2.0 Scope .....	2
3.0 Prerequisite .....	2
4.0 Definitions & Acronyms .....	2
5.0 Roles & Responsibilities .....	2
6.0 Standard – Specific Requirements .....	3
6.1 Manual Lifting Requirements .....	4
7.0 Training Requirements .....	5
8.0 Related Documents .....	5
9.0 Standard Review .....	5
10.0 References .....	5
11.0 Appendix .....	6
Change Log .....	7

## 1.0 PURPOSE

The standard provides preventive measures to support employees with eliminating injuries stemming from repetitive trauma and ergonomically induced hazards in the work place.

## 2.0 SCOPE

This standard applies to LP Operations and Projects being completed for LP.

Contractors and subcontractors shall comply with Enbridge health and safety requirements set out in this standard, as articulated within applicable contractor safety specifications. If a contractor or subcontractor has a health and safety standard or policy materially different from Enbridge's, the contractor/subcontractor shall follow the most stringent requirement. Contractors and subcontractors are still obligated to meet the requirements of all applicable laws related to this standard.

In the event a contractor's or subcontractor's standard exceeds the requirements of this standard, Enbridge may, in its sole discretion, choose to adopt the contractor's or subcontractor's standard for any given contract or work order.

Office ergonomics is not within the scope of this standard.

## 3.0 PREREQUISITE

Hazard Assessment & Control Standard

## 4.0 DEFINITIONS & ACRONYMS

*Ergonomics* - is the science of fitting the workplace to the worker, not fitting the worker to the workplace. Ergonomics is concerned with designing working systems in which human beings interact with machines and workplace tasks.

*Musculoskeletal Injury (MSI)* - an injury or disorder of the muscles, tendons, ligaments, joints, nerves, blood vessels or related soft tissue including a sprain, strain and inflammation, that may be caused or aggravated by work.

## 5.0 ROLES & RESPONSIBILITIES

People Leaders shall:

- Be knowledgeable and compliant to this Standard; and
- Support implementation of field level hazard assessment mitigations as recommended by employees.

Employees shall:

- Be knowledgeable and compliant to this Standard;
- Understand lifting expectations and use of best practice lifting techniques; and

- Report musculoskeletal related concerns to People Leader.

Safety Team shall:

- Provide timely advice, support and assistance to People Leaders and employees in the implementation of this Standard; and
- When requested by a People Leader or employee, review individual task assignments for potential ergonomic stresses and corrective action.

Safety Shared Services shall:

- Be responsible for the maintenance and continuous improvement of this Standard.

## 6.0 STANDARD – SPECIFIC REQUIREMENTS

Field work that is most likely to pose ergonomic hazards to a worker includes:

- Manual handling;
- Heavy lifting;
- Twisting movements;
- Repetitive and static postures;
- Compression or contact stress; and
- Long hours of working in awkward positions.

Workers can address these hazards through the completion of a detailed field level hazard assessment that may utilize some of the preferred mitigative controls listed below:

- Using proper lifting techniques;
- Good housekeeping;
- Worker rotation, more task variety, and increased rest breaks if necessary;
- Personal protective equipment, such as knee pads, vibration gloves, and similar devices;
- Appropriate tool or equipment selection for that job; and
- Utilize appropriate lifting equipment where applicable.

When acquiring tools for regular use consider the following ergonomic features:

- Tools should be light-weight and handles designed to allow a relaxed grip so the wrists can remain straight;
- Tools should be designed for use with either hand, and be of various sizes so they are appropriate for all workers;

- Tool handles should be shaped so that they contact the largest possible surface of the inner hand and fingers. Avoid tool handles with sharp edges and corners;
- Use power tools to reduce the amount of human force and repetition required; and
- Purchase low-vibration tools to reduce tool vibration, and, if necessary, fit absorbent rubber sleeves over the tool handle.

## 6.1 MANUAL LIFTING REQUIREMENTS

Regional or Project field office workers whose primary tasks do not include manual lifting (i.e., administrative roles) must not manually lift or carry materials, goods or things in excess of 23 kg (50 lbs).

Where an employee is required manually to lift or carry loads weighing in excess of 10 kg (22 lbs), the employee shall utilize the following basic diagonal lifting technique:

1. Get as close to the object as possible.
2. Use a wide stance with one foot forward and to the side of the object for good balance.
3. Keep your back straight, push your buttocks out, and use your legs and hips to lower yourself down to the object.
4. Slide the object as close to you as possible.
5. Put the hand (same side of your body as the forward foot) on the side of the object furthest from you.
6. Use this basic lifting technique for small objects when you can straddle the load and use a wide stance.
7. Put the other hand on the side of the object closest to you. Your hands should be on opposite corners.
8. Grasp the object firmly with both hands.
9. Prepare for the lift, tighten your core muscles, look forward and upward, keep a straight and strong back.
10. Lift slowly and follow your head and shoulders. Hold the load close to your body. Lift by extending your legs with your back straight and breathe out as you lift.

For additional information on the recommended weight limit (23 kg / 50 lbs) that can be lifted safely at different vertical and horizontal distances please see the associated chart located in the Appendix of this Standard.

Employees are discouraged to manually lift or carry loads weighing in excess of 45 kg (99 lbs) or weights they are not comfortable lifting by themselves. Where possible utilize a dolly, cart, pallet



jack or similar. Where feasible, lifting aids (lift tables, mechanical or powered assists, hoists, etc.) should be used to move heavy or bulky loads.

Where an employee is required to manually lift or carry loads in excess of 45 kg (99 lbs), a field level hazard assessment must be completed prior to task commencement.

## **7.0 TRAINING REQUIREMENTS**

Personnel working in the field must be knowledgeable in this Standard and may be assigned applicable training as driven by the Safety Training Matrix.

Reference the Health & Safety training syllabi and matrices for further information and training re-certification requirements.

## **8.0 RELATED DOCUMENTS**

None

## **9.0 STANDARD REVIEW**

A subject matter expert (SME) will perform a technical review of this standard every two years to determine the accuracy of the content/information. The SME shall solicit input from applicable stakeholders to ensure the effectiveness of the standard. Any suggested changes must be reviewed and approved by the designated document owner.

## **10.0 REFERENCES**

Applications Manual for the Revised NIOSH Lifting Formula, January 1994

Canada Occupational Health and Safety Regulations - SOR/86-304 (Section 14.46 - 14.49)

Ergonomics: The Study of Work

OSHA Protocol for Developing Industry and Task Specific Ergonomic Guidelines

11.0 APPENDIX

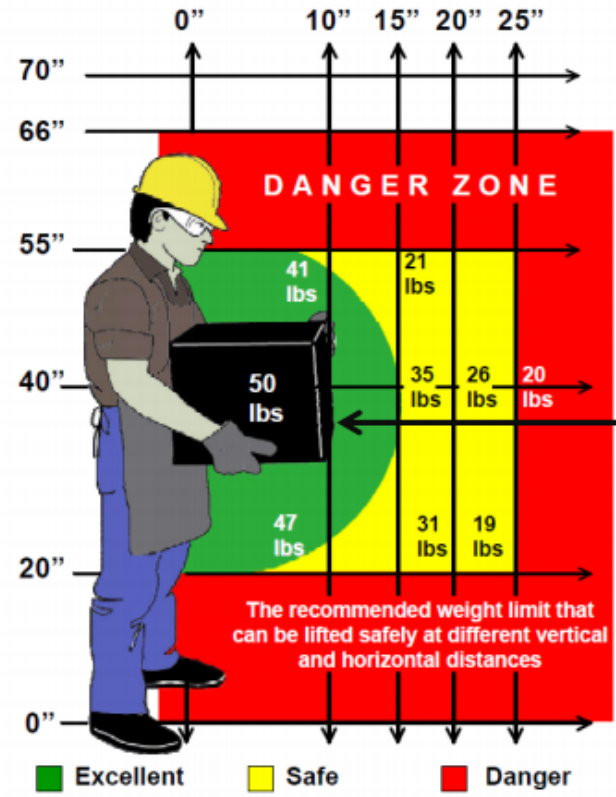

## CHANGE LOG

Section	Version 1.2	Version 1.3
Entire document		Clerical corrections including spelling, grammar, and document names.

<End of Document>



---

# Standard

---

## Flagging and Warning Signs

---

**Effective Date:** 2019-03-30  
**Version #:** 1.2  
**Version Date:** 2024-03-27

---



This page intentionally left blank



Document Version Register

Version Number	Version Date	Approved By	Section Number and Title	Details of Version
1.0	2019-03-30	Sean Evans	Whole Document (New Standard)	This is the new H&S standard that was developed as part of the LP   MP Safety Manual Transition Project
1.1	2020-06-01	Sean Evans	2.0	Alignment with Contractor Safety Specifications
1.2	2024-03-27	Troy Croft	All sections	Clerical corrections

Uncontrolled Copy if Printed or Downloaded

Internal Information



This page intentionally left blank



---

## Table of Contents

1.0 Purpose .....	2
2.0 Scope .....	2
3.0 Prerequisites.....	2
4.0 Definitions & Acronyms .....	2
5.0 Roles & Responsibilities.....	3
6.0 Standard-Specific Requirements .....	3
6.1 Flagging Tape.....	4
6.2 Flagging Tag.....	5
6.3 Warning Signs .....	5
6.4 Specialized Work.....	6
6.5 Flagging and Barricade Removal .....	6
7.0 Training Requirements .....	7
8.0 Related Documents .....	7
9.0 Standard Review .....	7
10.0 References .....	7
Change Log.....	7



## **1.0 PURPOSE**

This standard establishes the criteria for placing and removing flagging tape, barricades and warning signs around areas where work hazards may exist across Liquids Pipelines and Major Projects.

## **2.0 SCOPE**

This standard applies to LP Operations and to projects being completed for LP.

Contractors and subcontractors shall comply with Enbridge health and safety requirements set out in this standard, as articulated within applicable contractor safety specifications. If a contractor or subcontractor has a health and safety standard or policy materially different from Enbridge's, the contractor/subcontractor shall follow the most stringent requirement. Contractors and subcontractors are still obligated to meet the requirements of all applicable laws related to this standard.

In the event a contractor's or subcontractor's standard exceeds the requirements of this standard, Enbridge may, in its sole discretion, choose to adopt the contractor's or subcontractor's standard for any given contract or work order.

## **3.0 PREREQUISITES**

Fall Protection Standard

Hazard Assessment, Elimination and Control Standard

Inspection Standard

Safe Work Permit and Work Authorization Standard

Walking-Working Surfaces and General Housekeeping Standard

## **4.0 DEFINITIONS & ACRONYMS**

*Applicable Legislation* - All federal, provincial, state and municipal laws, regulations, codes, by-laws, ordinances or otherwise that are applicable to the jurisdiction in which the work is conducted including, but not limited to the Canada Labour Code, OSHA, State OSHA, Provincial and Territorial OH&S

*Barricade* - an obstruction to deter the passage of persons or vehicles.

*Field level hazard assessment (FLHA)* - A tool used just prior to the start of work to identify, assess and control the field-based hazards of the work being performed, and site or environmental conditions that may adversely affect the work (e.g. icy conditions, simultaneous operations, pedestrians).

*Flagging tape* - Colored, non-adhesive ribbon used for tagging, roping off, or other marking applications.

*Hazardous area* - an area in which there is significant potential for a flammable or toxic atmosphere to be present or develop.

*PPE* – Personal protective equipment

*Qualified* - one who, by possession of a recognized degree, certificate, or professional standing, or who by knowledge, training and experience, has successfully demonstrated his ability to solve or resolve problems relating to the subject matter, the work, or the project.

*ROW* – Right of way

*Safety watch* - a qualified worker responsible for monitoring work activities to ensure safe work practices are followed, to identify hazards, to alert workers of hazardous conditions and to initiate emergency response procedures.

*Safe work permit* - an agreement between the permit issuer and receiver that is used to authorize work for a specific time and location and to ensure a safe area of work for the working group.

## **5.0 ROLES & RESPONSIBILITIES**

People Leaders shall:

- Ensure that employees, contractors and subcontractors under their control are aware of and comply with this standard; and
- Confirm that all requirements of the safe work permit and/or work authorization are being followed.

Workers shall:

- Understand and implement expectations of the safe work permit and field level hazard assessment;
- Ensure placement and removal of flagging and barricades as required; and
- Be aware of the hazard and exercise caution before crossing into a flagged off or barricaded area.

Safety Team shall:

- Provide timely advice, support and assistance to people leaders in the implementation of this standard.

Safety Shared Services shall:

- Be responsible for the maintenance and continuous improvement of this standard.

## **6.0 STANDARD-SPECIFIC REQUIREMENTS**

The basic use of flagging tape is to warn people of general hazards prior to their exposure.

Flagging tape will be placed in a location to provide sufficient warning to workers to protect them from the hazard. Workers are not to cross flagging tape without permission from those who installed it.

In certain situations, flagging tape is not adequate to control entrance into a hazardous area such as:

- Open trenches;
- Excavation areas;
- Floor openings; and/or
- Areas where handrails have been removed.

In these situations, it is necessary to install additional fall protection controls to prevent personnel from falling or otherwise being injured.

## **6.1 FLAGGING TAPE**

Flagging tape shall be used as a warning to workers of hazards that exist in work areas. Flagging tape shall be:

- Installed to completely encompass the work area containing the potential hazard, including access from levels above or below;
- Prominently placed when conditions or activities may or do present a hazard to workers or the public;
- Placed to ensure workers cannot enter the area where the hazard exists, without prior knowledge of the hazard; and
- Removed when the potential hazard no longer exists.

Workers shall not enter flagged or barricaded areas until they:

- Obtain permission to enter the controlled area;
- Understand the hazards within the area by signing onto the field level hazard assessment; and
- Take necessary safety precautions.

The following types of flagging shall be used:

- **RED**—"Danger Do Not Enter"—Red with black lettering. This type of flagging is used where there is danger of an imminent hazard, such as crane lift zones, leaks, or a potential for falling objects. Only workers directly involved in the work are allowed in these areas. All others must obtain prior permission from the flagging owner (i.e. worker who installed the flagging) and sign onto the field level hazard assessment prior to entering the area.

- **YELLOW**—“Caution”—Yellow with black lettering. Yellow flagging is used to identify an area where a hazard exists that may cause injury or harm. Individuals may enter yellow flagged areas if they first read the associated tag and are aware of the hazards present and follow required control measures associated with the stated hazard.

## **6.2 FLAGGING TAG**

A flagging tag shall be attached to all flagging tape. Multiple tags may be required depending on work area and hazards. The worker installing the tape shall complete the tag with the following information:

- Name of the person who installed the flagging;
- Phone number or radio channel for contact;
- Date on which the flagging was installed; and
- Reason for the use of flagging.

Instead of flagging or barricades, a safety watch may be used to prevent workers from entering the hazardous area, but only if the area is small enough to be easily managed and the safety watch remains in place until the hazard no longer exists.

## **6.3 WARNING SIGNS**

Warning signs identifying known hazards shall be posted to warn workers and others in the area of the specific hazard. All signs shall be constructed in a professional manner and shall meet applicable legislation and Enbridge’s design and installation standards. Contact the Enbridge branding and engineering department for design and installation requirements.

Warnings signs include, but are not limited to:

- Directional signs:
  - Installed as required,
- “No Trespassing,” “Open Ditch” or “Danger/Open Excavation”,
- The signs shall be:
  - Posted as appropriate to ensure visibility as required to all personnel accessing the work area;
  - Face the intersecting road/highway, where construction activities are being conducted;
  - Display a contact telephone number for unauthorized workers to contact.

- Construction warning signs:
  - All crossings of any interstate, highway, municipal or private roads shall be posted with construction warning signs, which are designed and positioned in accordance with the requirements of the applicable legislation. Such signs shall be clearly visible to traffic, as appropriate to the crossing, e.g., visible from two or more directions,
- High pressure testing signs:
  - Shall be posted:
    - At all entries to the ROW, public access points and facility buildings while sections are under test;
    - Facing intersecting roads/highways.
- Smoke warning signs:
  - Warning signs shall be used to warn traffic of poor visibility due to smoke from brush burning operations. All such warning signs shall be in accordance with applicable legislation.
- Other warning signs shall be erected as required by applicable legislation or by Enbridge to warn workers and/or the public of a range of potential hazards such as:
  - Traffic Hazards (e.g., STOP, slow, curve, steep hill, noise hazards, caution, work crews ahead, suggested speed restrictions, trucks turning, work in/over navigable waters);
  - Signs indicating venting in progress during any venting activities;
  - “Caution: Open Hole” or similar when there is an opening;
  - Overhead hazards;
  - Respiratory hazards; and
  - PPE requirements (e.g., hard hat, hearing protection, eye protection).

## **6.4 SPECIALIZED WORK**

Where specialized work such as asbestos removal, lead abatement, or radiation work is being performed, access is restricted to all persons unless they are qualified to be in the area and signed in on the safe work permit.

## **6.5 FLAGGING AND BARRICADE REMOVAL**

Barricading or flagging tape material will be taken down immediately following the removal of the hazard.

The same job position or person(s) who installed it or anyone associated with the task being protected, upon conclusion of the job, are responsible for taking it down.

## 7.0 TRAINING REQUIREMENTS

Personnel working in the field must be knowledgeable in this Standard and may be assigned applicable training as driven by the Safety Training Matrix.

Reference the Health & Safety training syllabi and matrices for further information and training re-certification requirements.

## 8.0 RELATED DOCUMENTS

Not applicable

## 9.0 STANDARD REVIEW

This standard shall be reviewed by a designated owner annually and a technical review committee every two years.

Technical reviews shall solicit input from non-managerial field employees to ensure the effectiveness of the standard.

## 10.0 REFERENCES

Occupational Safety and Health Administration (OSHA)

- Safety Color Code for Marking Physical Hazards - 1910.144
- Specifications for Accident Prevention Signs and Tags - 1910.145

## CHANGE LOG

Section	Version 1.1	Version 1.2
Entire document		Clerical corrections including spelling, grammar, and document names.

<End of Document>



---

# Standard

---

## Hazard Assessment & Control

---

**Effective Date:** 2019-03-30

**Version #:** 1.6

**Version Date:** 2024-03-27

---



This page intentionally left blank





**Document Version Register**

Version Number	Version Date	Approved By	Section Number and Title	Details of Version
1.0	2019-03-30	Sean Evans	Whole Document (New Standard)	This is the new H&S standard that was developed as part of the LP   MP Safety Manual Transition Project
1.1	2019-10-31	Sean Evans	5.0, 6.1	See change log
1.2	2020-06-01	Sean Evans	2.0, 5.0	Alignment with Contractor Safety Specifications
1.3	2021-07-19	Murray Evenson	6.5	Updated work flow chart
1.4	2021-06-01	Murray Evenson	6.3.1, 9.0, 10.0	Updated section 9 to reflect the appropriate review process Administrative updates to section 6.3.1 & 10.0
1.5	2022-07-19	Jeff Safioles	6.3	See change log for details
1.6	2024-03-27	Troy Croft	All sections	Clerical corrections

**Uncontrolled Copy if Printed or Downloaded**

**Internal Information**



This page intentionally left blank

---

## Table of Contents

1.0	Purpose .....	3
2.0	Scope .....	3
3.0	Prerequisites.....	3
4.0	Definitions & Acronyms .....	3
5.0	Roles & Responsibilities .....	4
6.0	Standard-Specific Requirements .....	6
6.1	Hazard Assessments.....	6
6.2	Hierarchy of Controls .....	6
6.3	Types of Hazard Assessments.....	7
6.3.1	Job Hazard Assessment.....	7
6.3.2	Field Level Hazard Assessment .....	8
6.3.3	Facility Hazard Assessment (FHA).....	9
6.3.4	Project and Contractor Hazard Assessments.....	9
6.4	Critical Task Analysis .....	10
6.5	Hazard Assessment Workflows.....	11
6.6	Tools for Identifying, Analyzing and Registering Hazards.....	12
6.6.1	Energy Wheel Hazard Identification Methodology .....	12
6.7	Communicating Hazards .....	12
7.0	Training Requirements:.....	12
8.0	Related Documents .....	13
9.0	Standard Review .....	13
10.0	References .....	13
11.0	Appendix.....	14
11.1	Field Level Hazard Assessment .....	14
11.2	Critical Task Analysis Form .....	16



---

11.3	Job Hazard Assessment.....	17
11.4	Facility Hazard Assessment - Hyperlink.....	19

---

## 1.0 PURPOSE

The purpose of this standard is to ensure that Enbridge workforce and contractors use accepted methods to identify hazards and associated risks assess consequences and define mitigation measures needed to execute processes with worker safety as a priority. The standard also provides the methods necessary for communicating hazards with the workers who are most likely to interface with them.

## 2.0 SCOPE

This standard applies to LP Operations and Projects being completed for LP.

Contractors and subcontractors shall comply with Enbridge health and safety requirements set out in this standard, as articulated within applicable contractor safety specifications. If a contractor or subcontractor has a health and safety standard or policy materially different from Enbridge's, the contractor/subcontractor shall follow the most stringent requirement. Contractors and subcontractors are still obligated to meet the requirements of all applicable laws related to this standard.

In the event a contractor's or subcontractor's standard exceeds the requirements of this standard, Enbridge may, in its sole discretion, choose to adopt the contractor's or subcontractor's standard for any given contract or work order.

## 3.0 PREREQUISITES

Lessons Learned Standard

Safety Meetings, Tailgate & Toolbox Talks Standard

Safety Orientation & Visitor Access Standard

Safe Work Permit & Work Authorization Standard

## 4.0 DEFINITIONS & ACRONYMS

*ALARA*— *As low as reasonably achievable.*

*Contractor* - A legal entity with whom Enbridge may enter into an agreement for the provision of labor, materials and/or equipment by the Contractor in the delivery of a specified scope.

*Critical Task*—A task which has the potential to produce major loss to people, property, process and/or environment when not performed properly.

*CTA*—Critical Task Analysis is a systematic review of a specific task to break down tasks with the goal of identifying and controlling hazards per task steps.

*FHA* – Facility Hazard Assessment

*FLHA*—Field Level Hazard Assessment is a hazard assessment completed at the immediate work site that assesses the hazards associated with the environmental conditions, nearby work, small tasks or hazards that could not be identified during the planning stages of jobs.

*Hazard*—Source or situation with a potential for harm in terms of injury, ill health, damage to property, damage to workplace and environment, or any other definitions as set out by regulations and codes

*Job Hazard Assessment (JHA)*—A hazard assessment completed in the planning phase of a job to identify and evaluate hazards in order to eliminate or control them.

*PPE* – Personal Protective Equipment

*Procedure*—A step-by-step description of how to proceed, from start to finish, in performing a task properly.

*Risk*—Effect of uncertainty on objectives; characterized by reference to events, sources and consequences; expressed in terms of a combination of the consequences of an event and the associated likelihood.

*Site Safety Plot Plan*—Site-specific drawing that shows hazardous and restricted areas, primary evacuation site, secondary evacuation site, helicopter landing areas and the location of safety facilities and equipment (e.g., evacuation alarms, wind socks, fire extinguishers and first aid stations).

*SWP*—Safe Work Permit.

*Task*—Segment of work which requires a set of specific and distinct actions for its completion.

## **5.0 ROLES & RESPONSIBILITIES**

Regional, department, project management shall ensure:

- Workers are trained to assess potential and existing hazards specific to their work activities including hazard identification, assessment and control;
- Hazard assessments of work activities and worksites are completed as required, and where reasonably practicable, everyone involved in a work activity participates in the respective hazard assessment for that work; and
- Documentation and retention of hazard assessments as per document retention requirements.

Contractor management shall, as articulated within the applicable contractor safety specifications, ensure:

- Workers are trained to assess potential and existing hazards specific to their work activities including hazard identification, assessment and control;

- Hazard assessments of work activities and worksites are completed as required, and where reasonably practicable, everyone involved in a work activity participates in the respective hazard assessment for that work; and
- Documentation and retention of hazard assessments as per document retention requirements.

People Leaders shall:

- Ensure workers are trained to assess potential and existing hazards specific to their work activities including hazard identification, assessment and control;
- Ensure known and potential safety hazards inherent to the facility are recognized, assessed and controlled (captured/documentated);
- Ensure that hazard assessments are communicated to all workers involved in work activity;
- Ensure everyone involved in a work activity participates in completing or reviewing the respective hazard assessment for that work;
- Ensure appropriate use of the required hazard assessment tools;
- Ensure that all workers are adequately trained in the hazard assessment process and tools given the scope of the work;
- Periodically review and assess in-progress work to ensure that the tools are adequate to identify the hazards, and the controls implemented have reduced the risk associated with the work to ALARA levels; and
- Verify that workers and work groups involved in the work have acknowledged the hazard assessment outputs (hazards and controls) and these are put to practical use during work execution.

Workers shall:

- Complete hazard assessments of work activities and worksites as required;
- Understand the hazard assessment process and specific responsibilities as they apply to each worker; and
- Participate actively in the hazard assessment process while ensuring that an appropriate level of recognition, assessment and control is completed before the start of all work.

Safety Team shall:

- Provide timely advice, support and assistance to people leaders and contractors in the implementation of this standard;
- Ensure effectiveness of the hazard assessment program and hazard assessment training for workers is sufficient; and
- Ensure that opportunities for improvement are identified and implemented, as part of continuous improvement of the hazard assessment process.

Safety Shared Services shall:

- Be responsible for the maintenance and continuous improvement of this standard.

## **6.0 STANDARD-SPECIFIC REQUIREMENTS**

### **6.1 HAZARD ASSESSMENTS**

A hazard assessment is required and shall be documented for all work activities, except:

- Office related work (e.g. computer use, training, meetings);
- Travel between work locations; and/or
- Light housekeeping.

These exceptions do not take away a worker's responsibility to assess hazards. Workers shall continue to practice cognitive hazard assessment techniques (e.g. stop, look, assess, and manage).

Hazard assessments shall include all workers involved with the work and are most effective when completed in the planning phase of work. The results of the assessment shall be communicated to all other workers who may be affected by the work.

### **6.2 HIERARCHY OF CONTROLS**

A hierarchy of intervention methods is presented below in the order of priority. In situations with multiple hazards or causal factors, a combination of control methods may be warranted.

1. Process Elimination—means elimination of non-value-added processes, job tasks, motion, transportation and uncomfortable layouts. Elimination may be achieved by design/redesign, modifications or different approaches, e.g., lifting down sample cans from workstations and lifting them up to the trucks may be eliminated by using a cart.
2. Substitution—means substituting a new work process or tool for a work process or tool with no or less identified hazards. Substitution serves to eliminate the hazard. For example, hand tools that require awkward wrist positions such as extreme wrist flexion, extension or deviation can be replaced with tools that allow a neutral wrist posture.



3. Engineering Controls—changes are made to the workstations, tools and/or machinery that alter the physical composition of the human-machine interface or process so that the risk factors are eliminated or reduced.
4. Administrative controls—means controls used to limit the duration, frequency and severity of exposure to work-related hazards. Examples of administrative controls include, but are not limited to: providing rest breaks, doing stretching exercises, providing opportunities for job enrichment, limiting overtime work and instituting job rotation.
5. Personal Protective Equipment (PPE)—PPE may be used as an interim measure to control work-related hazards but must not be used as a permanent control when other controls are feasible.

Hazard controls require planning of work to ensure itemization of specific work steps, identification of the hazards associated with each work step and placement of controls to either eliminate or control hazards to ALARA. The hazard assessment tools are effective at identifying engineering and administrative controls, which can be developed as a part of the planning phase thereby reducing the reliance on PPE as the primary means of control at a worksite.

### **6.3 TYPES OF HAZARD ASSESSMENTS**

A Field Level Hazard Assessment is the most basic level of Hazard Assessment. If the same hazards exist for a work scope or a task, instead of repeating them daily on the FLHA, create a JHA and then review the Job Hazard Assessment. Please see the detailed descriptions for these requirements and the process flows for a visualization of this process.

Enbridge uses several distinct types of hazard assessments to identify, assess and control hazards associated with the design, construction, operation and maintenance of the company facilities and assets. This includes:

- Job Hazard Assessment (JHA)
- Field Level Hazard Assessment (FLHA)
- Critical Task Analysis (CTA)
- Facility Hazard Assessment (FHA)

During assessment activities, if an isolation point is found to be tagged or labeled incorrectly or the tag/label is missing, any work taking place shall be stopped until the tag or label is corrected or replaced. Refer to section '6.6 – Lockout/Tagout Assurance Process for Asset Management' in the Controls of Hazardous Energy Safety Standard.

#### **6.3.1 JOB HAZARD ASSESSMENT**

The Job Hazard Assessment (JHA) outlines controls for hazards associated with specific jobs or tasks. These controls may be specific to a task, or reference standards and procedures to be followed at certain points in a job. The JHA is meant to assess controls that potentially need

to be planned out in advance during the planning phase of work (working in darkness, electrical hazards, lifting, etc.).

This may include jobs where there will be multiple work groups involved and multiple tasks completed. Work planning tools for complex multi-faceted jobs and other non-routine work where exposure to open systems, high voltage electrical work or other high potential hazards exist have JHA's built into the planning tool and do not require a standalone JHA. Once a JHA has been completed as part of a planning tool it should be reviewed prior to starting work.

For workers that conduct routine tasks daily, where the hazards associated with that task do not change and the controls are the same on a day-to-day basis, complete a JHA for that workers job role by task that can be reviewed prior to starting work. Completion of this JHA should capture the hazards that are inherent to the work that we mitigate through procedures, specialized PPE and administrative controls that will not vary on a day-to-day basis. JHAs for these job roles should be kept on site and available for daily use. If a JHA has not been created for a particular task within a job role, the hazard assessment for that task can be captured on the FLHA until such time as the JHA has been completed.

Safe work permits and field level hazard assessments are still required with the use of JHAs.

Once a standalone JHA is created they will be reviewed and updated annually for accuracy and alignment to other work practices and hazard controls. JHA's as part of planning templates will be reviewed as part of the planning template review on that specific plan's schedule.

On the JHA template is a list of common hazards based on the Energy Wheel (see Section 6.6.1) and controls associated with planned work. The list also takes into consideration ergonomic and hazardous conditions as hazards that may need to be controlled. The list may be used to help complete JHAs and is a part of the *Job Hazard Assessment Form* (see Appendix).

### **6.3.2 FIELD LEVEL HAZARD ASSESSMENT**

The FLHA tool is used daily by all workers at the immediate work site, just prior to work execution. This hazard assessment process will be documented using the FLHA tool.

The distinguishing factor between an FLHA and other hazard assessment tools is that it is used to identify unforeseen, newly developed, or changing hazards at the immediate work site. It is a field tool, meant for and to be used to recognize, identify and control hazards that are immediately apparent or foreseeable as a result of workers being present in the task location. The intent of the FLHA is to identify, communicate, and document hazardous energy sources that may adversely affect the work (e.g. motion, gravity, mechanical, electrical, pressure, chemical, biological, temperature, radiation, noise) as well as any items that are unique to the task environment that may cause a variable to work conditions.

An FLHA may cover individual or group work provided the group is performing the same task. All workers performing the work shall participate in the FLHA discussion and completion. Any

additional workers joining the work activity shall review, attempt to identify additional hazards and controls, and acknowledge (sign) the active FLHA. If workers begin a new task in a new area, a new FLHA shall be required. If the same scope of work will be completed in a new area, review and update the FLHA to any new site hazards.

When an FLHA is required, it shall be completed and acknowledged (signed) by all involved workers prior to task commencement. If needed, the existing FLHA may be reviewed and updated as work changes throughout the shift providing the defined and permitted scope of work does not change.

All work that requires an SWP requires an associated FLHA for the scope of work covered by the SWP. If scope of work changes for any permit-required work, a new FLHA shall be completed. The FLHA should be reviewed prior to returning to work after a prolonged (i.e. more than 1 hour) work break.

Contractor-developed FLHA tools and processes will be accepted after review from the Enbridge representative overseeing the task (or designate). If it is not acceptable and the Enbridge FLHA is to be used, an Enbridge representative shall ensure the contractor is versed in the use of the Energy Wheel FLHA (see Section 6.6.1).

### **6.3.3 FACILITY HAZARD ASSESSMENT (FHA)**

All facilities and stations owned and/or operated by Enbridge are assessed for hazards inherent to the facility and its operations under normal operating conditions. FHAs shall be conducted for stations and terminals and be inclusive of all buildings and assets within the facility.

The assessment includes taking into account:

- The nature of the hazard,
- The controls in place to address the hazard.

These shall be documented on the facility hazard assessment. Post the FHA at the facility in conjunction with the site safety plot plans. This FHA is reviewed by the operating group at each facility every two years or as required based on facility/process changes, upgrades or additions and are updated as necessary to ensure they remain current. Use the facility hazard assessment to assist with orientations and training, completing hazard assessments, or communicating site hazards.

### **6.3.4 PROJECT AND CONTRACTOR HAZARD ASSESSMENTS**

Contractors will be required to complete hazard assessments to identify any known hazards applicable/unique to their work activities. Contractors shall complete a JHA for all general work activities that don't have a procedure. A copy of any completed hazard assessments for the project shall be provided to Enbridge for review prior to site mobilization. Key items and outputs from the hazard assessments should be provided to workers during contractor or site-specific

orientation. This review with workers is a critical component of the hazard assessment process and shall be completed prior to beginning work on site.

For brownfield sites, Enbridge shall provide a copy of the appropriate facility hazard assessment to the contractor outlining additional hazards associated with the facility that the contractor could see on the site.

Based on the scope and complexity of a project, a project safety plan shall be completed by the contractor prior to work beginning on Enbridge sites. Contractors with sizeable, complex or multiple scopes will be required to complete a project safety plan. The Enbridge representative (or designee) planning and/or overseeing the work reserves the right, at their discretion, to request hazard assessments are completed as part of that project safety plan and Enbridge will provide the contractor with written request prior to work commencement.

#### **6.4 CRITICAL TASK ANALYSIS**

The Critical Task Analysis (CTA) is used as a hazard assessment tool where a procedure does not already exist.

A CTA is not a field level hazard tool, it is meant to be completed on all new procedures by a multidisciplinary team who review job/task steps sequentially to assess the hazards associated with each job/task step. Procedures may be developed from the results of the CTA. This allows hazard controls and mitigations to be built into procedures when they are developed. Completed CTAs or the developed procedures shall be communicated to all workers who will be performing the task.

A CTA needs to be reviewed and potentially updated when operational processes, procedures or facility equipment changes.

## 6.5 HAZARD ASSESSMENT WORKFLOWS

The following workflows will be followed for operations and project activities:

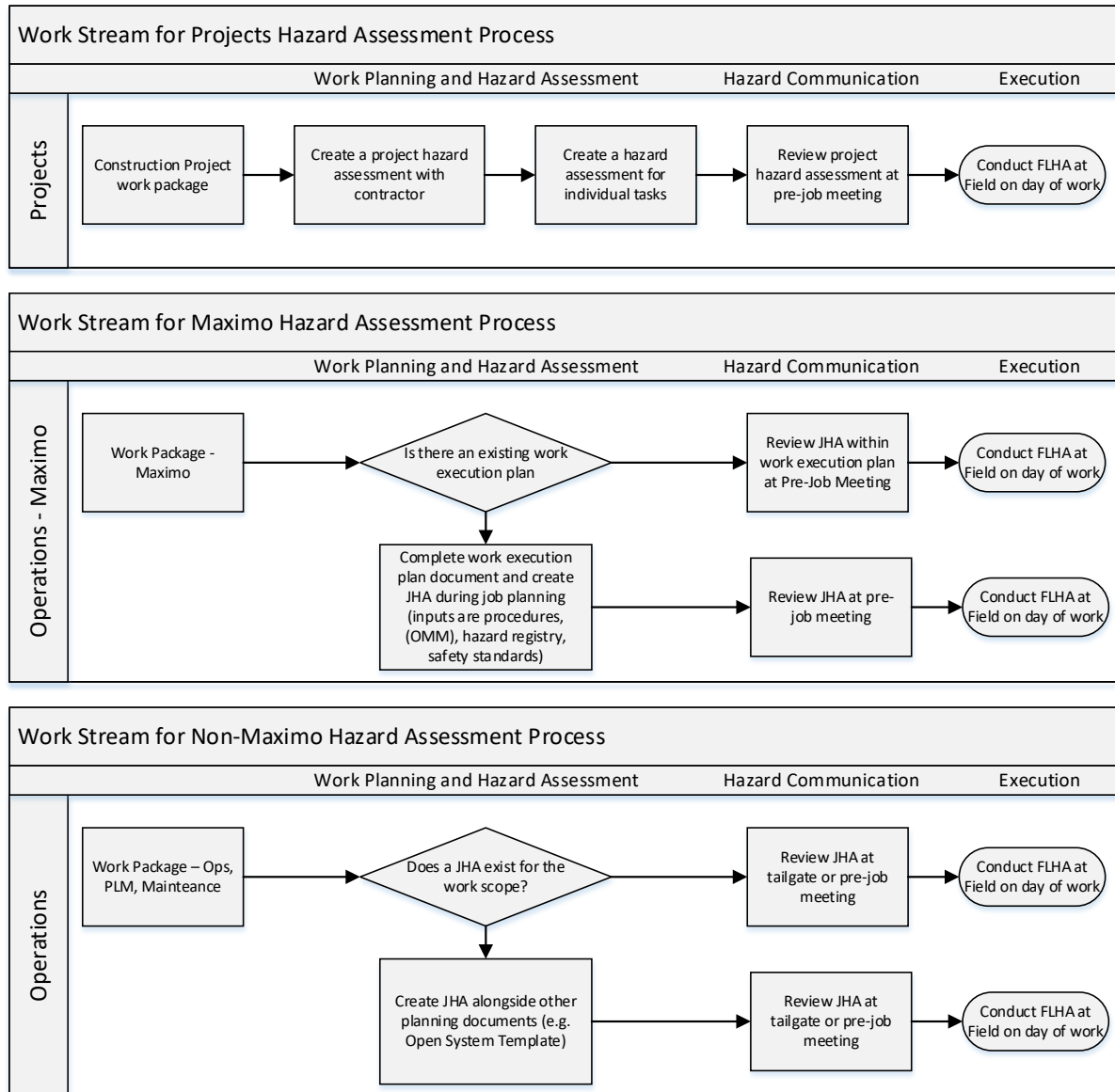

## 6.6 TOOLS FOR IDENTIFYING, ANALYZING AND REGISTERING HAZARDS

### 6.6.1 ENERGY WHEEL HAZARD IDENTIFICATION METHODOLOGY

The main hazard recognition methodology used is the Energy Wheel. This wheel is representative of the various forms of energy that pose potential to cause harm to people, property or assets. The energy wheel is used as a hazard recognition aid when conducting Hazard Assessments at both the planning and work execution phases.

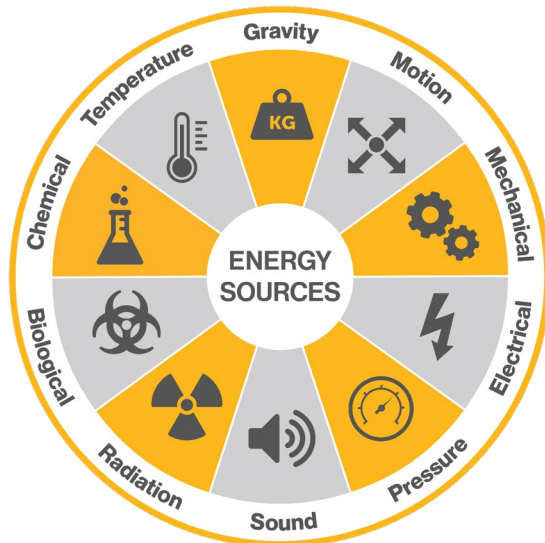

## 6.7 COMMUNICATING HAZARDS

The most effective way for communicating hazards to the frontline is directly engaging with the workers who will be performing the work. Outside of this hazard assessment process, there are additional methods which support communicating hazards to frontline personnel. This includes but is not limited to:

- Site safety orientations shall be used to communicate site specific hazards to contractors and visitors to site. Safety orientations shall be conducted annually for contractors and visitors to a site.
- Tailgate meetings and pre-job meetings shall be held to review and discuss the identified hazards and controls on the hazard assessment tools

For more information on how to effectively integrate these tools into daily work refer to the appropriate Safety Standard within the Governance Documents Library (GDL).

## 7.0 TRAINING REQUIREMENTS:

Personnel working in the field must be knowledgeable in this Standard and may be assigned applicable training as driven by the Safety Training Matrix.

---

Reference the Health & Safety training syllabi and matrices for further information and training re-certification requirements.

## **8.0 RELATED DOCUMENTS**

Not applicable

## **9.0 STANDARD REVIEW**

A subject matter expert (SME) will perform a technical review of this standard every two years to determine the accuracy of the content/information. The SME shall solicit input from applicable stakeholders to ensure the effectiveness of the standard. Any suggested changes must be reviewed and approved by the designated document owner.

## **10.0 REFERENCES**

Canada Labour Code, Part II – Occupational Health & Safety

- 124 Duties of Employers
- 125 Duties of Employees
- 135 Work Place Health & Safety Committees
- 136 Health & Safety Representatives

Canadian Energy Regulator Onshore Pipeline Regulations

- 29-30 Maintenance Safety

Canadian Occupational Safety & Health (COSH) regulations

- Part XIX Hazard Prevention Program

CSA Z662

Occupational Safety and Health Administration (OSHA)

- Hazard Communication, 29 CFR 1910.1200





Energy Type & Source	Hazard	Controls

SAMPLE

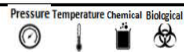

Ver 1.0

**11.2 CRITICAL TASK ANALYSIS FORM**

Critical Task Analyzed: \_\_\_\_\_  
 Date Completed: \_\_\_\_\_  
 Date Revised: \_\_\_\_\_  
 Completed by: \_\_\_\_\_

No.	Task Steps	Hazards	Consequences (financial, human, production, environmental losses)	Controls	Severity	Frequency	Probability	Criticality	Improvement Suggestions



**11.3 JOB HAZARD ASSESSMENT**

		<b>Job Hazard Assessment</b>		Associated Documents or permits (JPT, SWP, CSE):
Job/Project:		Prepared by:		Date:
Tasks	Sub-Task	Potential Hazards Associated With Task or Sub-Task	Administrative Controls, Engineering Control or other mitigations.	

SAMPLE

HAZARDS BY ENERGY TYPE	Gravity Hazards	Mechanical Hazards	Motion Hazards	Sound	Chemical	Temperature	Human Factors
CONTROLS	<ul style="list-style-type: none"> <li>System de-pressurized</li> <li>Purge/ventilate lines</li> <li>Gas detection</li> <li>Ventilation</li> <li>Energy isolation/LOTO</li> <li>Fire watch</li> <li>Fire extinguisher</li> <li>Spark containment</li> <li>Intrinsically safe equipment</li> <li>GFCIs</li> <li>Fall protection plan</li> <li>Fall arrest</li> <li>Fall restraint</li> <li>Exclusion zone</li> <li>Barricade/Guardrail</li> </ul>	<ul style="list-style-type: none"> <li>Scaffolding</li> <li>Ladders/stairs</li> <li>Mechanical lifting</li> <li>Rescue equipment</li> <li>Grounding/bonding</li> <li>Utility locales</li> <li>Trench box/shoring</li> <li>Proper excavation</li> <li>Ground leveling/planking</li> <li>Rig matting</li> <li>First aid kit</li> <li>Eye wash station</li> <li>Continuous air monitoring</li> <li>Emergency Shower</li> <li>Three point contact</li> </ul>	<ul style="list-style-type: none"> <li>Line of fire</li> <li>Mobile equipment</li> <li>Struck by/against</li> <li>Caught in between</li> <li>Unstable position</li> <li>Limited Access/Egress</li> <li>Congested area</li> <li>Simultaneous Operations</li> <li>Buried facilities</li> <li>Load shifting</li> <li>Vehicle Movement on site</li> <li>High speed traffic</li> <li>Minimal Clearance</li> <li>Unanticipated startup of equipment</li> <li>Heavy/awkward loads</li> <li>Overexertion</li> <li>Vibration</li> <li>Overreaching</li> <li>Manual lifting</li> <li>Repetitive motions</li> <li>Inadequate Lighting</li> <li>High Winds</li> <li>Limited Visibility</li> </ul>	<ul style="list-style-type: none"> <li>Loud vehicles</li> <li>Loud Tools/Equipment</li> <li>Loud environments</li> <li>Loud Equipment</li> <li>Pump Shelter</li> <li>Purging (Nitrogen)</li> <li>Pressure Relief Systems</li> </ul> <p><b>Electrical Hazards</b></p> <ul style="list-style-type: none"> <li>Electric Shock – Low Voltage</li> <li>Electric Shock – High Voltage</li> <li>Arc Flash/Blast</li> <li>Induced voltage</li> <li>Non-intrinsically safe tools/equipment</li> <li>Adapter cords</li> <li>Static electricity</li> <li>Energized Electrical Equipment/Lines – Normal/Abnormal Operating Conditions</li> <li>Stored Electrical Energy</li> <li>Fire eye protection</li> <li>Cathodic Protection</li> <li>Overhead Power Lines</li> <li>Underground Cables</li> </ul>	<ul style="list-style-type: none"> <li>Explosive/flammable</li> <li>Corrosive</li> <li>Oxidizing agents</li> <li>Acute/chronic toxicity</li> <li>Highly reactive</li> <li>Skin/eye irritants</li> <li>Hazardous Atmosphere</li> <li>Drowning</li> <li>Ignition sources</li> <li>Chemical Exposure</li> <li>Vapors</li> <li>Battery Acid</li> <li>Exhaust fumes</li> <li>Welding Fumes</li> <li>Air Quality</li> <li>Material Compatibility</li> <li>Chemical Reaction</li> <li>Pesticides</li> <li>Lack of ventilation</li> </ul> <p><b>Radiation</b></p> <ul style="list-style-type: none"> <li>X-rays</li> <li>Naturally Occurring Radioactive Material (NORM)</li> <li>Radon</li> <li>Geiger counter</li> <li>Radon detector</li> <li>Radon radon (sublim)</li> <li>Welding flash</li> <li>Infrared Scanners</li> </ul>	<ul style="list-style-type: none"> <li>Extreme cold</li> <li>Extreme Heat</li> <li>Chemical Reaction</li> <li>Wind chill</li> <li>Hot Surfaces (Friction/Heat)</li> <li>Cold Surfaces (Nitrogen, NGL, Propane)</li> <li>Ignition Sources</li> <li>Dry Conditions</li> <li>Damp/Wet Conditions</li> <li>Snow/Ice</li> <li>Lack of Ventilation</li> </ul> <p><b>Biological</b></p> <ul style="list-style-type: none"> <li>Plant</li> <li>Animals</li> <li>Birds</li> <li>Reptiles</li> <li>Insect</li> <li>Mold</li> <li>Bloodborne Pathogens</li> <li>Asbestos</li> <li>Silica</li> <li>Bacteria</li> <li>Viruses</li> </ul>	<ul style="list-style-type: none"> <li>Knowledge/Skill</li> <li>Deviation from Plan</li> <li>Communication</li> <li>Risk Tolerance</li> <li>Fit for Duty</li> <li>Worker Fatigue</li> <li>New/inexperienced workers</li> <li>Working alone</li> <li>Remote access to ER</li> <li>Personal Limitations</li> </ul>
	<ul style="list-style-type: none"> <li>High visibility vest</li> <li>Personal Flotation Devices</li> <li>Chemical clothes, boots</li> <li>Resp. protection                             <ul style="list-style-type: none"> <li>1/2 mask</li> <li>full face</li> <li>Cartridge</li> <li>Supplied air</li> <li>SCBA</li> </ul> </li> </ul>			<ul style="list-style-type: none"> <li>Work/rest cycles</li> <li>Restricted work hours</li> <li>SME support</li> <li>Worker rotation</li> <li>Communication plan</li> <li>Extraction/rescue plan</li> <li>Electrical safe approach</li> <li>Access to SDS</li> <li>Proper disposal of waste</li> <li>Task Specific Training</li> <li>Lift Plan</li> <li>Confined Space Rescue Plan</li> <li>Review Drawing</li> <li>Welding screen</li> <li>Fire blanket</li> <li>Tag lines</li> </ul>	<ul style="list-style-type: none"> <li>Goggles</li> <li>Face shield</li> <li>Hearing protection</li> <li>Protective footwear</li> <li>Slip resistant footwear</li> <li>Arc flash PPE</li> <li>FR clothing</li> <li>Specific Gloves for task</li> <li>Fire extinguisher</li> <li>Equipment pre-use inspection</li> <li>Rigging load rating checked</li> <li>Warning signs</li> </ul>		

---

## 11.4 FACILITY HAZARD ASSESSMENT - HYPERLINK

[Facility Hazard Assessment](#) (Click link to open)

### CHANGE LOG

Section	Version 1.5	Version 1.6
Entire document		Clerical corrections including spelling, grammar, and document names.

<End of Document>



---

# Standard

---

## Hazard Communication & WHMIS Standard

---

**Effective Date:** 2019-03-30

**Version #:** 2.1

**Version Date:** 2024-03-27

---



This page intentionally left blank



**Document Version Register**

Version Number	Version Date	Approved By	Section Number and Title	Details of Version
1.0	2019-03-30	Sean Evans	Whole Document (New Standard)	This is the new H&S standard that was developed as part of the LP/MP Safety Manual Transition Project
1.1	2020-06-01	Sean Evans	2.0	Alignment with Contractor Safety Specifications
1.2	2021-12-01	Murray Evenson	9.0	Updated section 9 to reflect the appropriate review process
2.0	2022-03-02	Murray Evenson	Various sections	Updated various sections in standard including the addition of an updated chemical approval process for new chemicals
2.1	2024-03-27	Troy Croft	All sections	Clerical corrections

Uncontrolled Copy if Printed or Downloaded

Internal Information





This page intentionally left blank

---

## Table of Contents

1.0	Purpose .....	3
2.0	Scope .....	3
3.0	Prerequisites.....	3
4.0	Definitions & Acronyms .....	3
5.0	Roles & Responsibilities.....	4
6.0	Standard-Specific Requirements .....	5
6.1	Availability of the HCP .....	5
6.1.1	Non-Routine Tasks Requirement .....	5
6.2	Multi-Employer Work Sites .....	6
6.2.1	Enbridge Obligations to Contractors.....	6
6.2.2	Contractor Obligations .....	6
6.3	Hazardous Chemical List.....	7
6.4	Safety Data Sheet (SDS) Requirements .....	7
6.5	Labels & Warnings Requirements .....	9
6.5.1	Incoming Hazardous Chemical Containers .....	9
6.5.2	Workplace (in-house) Container Labels & Markings .....	10
7.0	Training.....	10
8.0	Related Documents .....	11
9.0	Standard Review .....	11
10.0	References .....	11
11.0	Appendix.....	12
11.1	HMIS and NFPA SDS and Label Requirements (US).....	12
11.1.1	Hazard Communication Safety Data Sheets .....	12
11.1.2	Pictograms and Hazards .....	13
11.1.3	Hazard Communication Labels .....	14



---

11.1.4	NFPA 704 & HMIS III rating systems can be found on product labels, secondary labels and MSDS: .....	15
11.1.5	Special Handling & Personal Protection .....	16
11.2	WHMIS SDS and Label Requirements (CAN) .....	17
11.2.1	HPR specifies the sections and content for the SDS as follows: .....	17
11.2.2	Pictograms and Hazards .....	20
11.2.3	Supplier Labels .....	21
11.2.4	An example of a bilingual label is shown below: .....	22
	Change Log .....	23

## 1.0 PURPOSE

The purpose of this standard is to provide a common and coherent approach for:

- Classifying chemicals, and
- Communicating hazard information on labels and safety data sheets.

## 2.0 SCOPE

Contractors and subcontractors shall comply with Enbridge health and safety requirements set out in this standard, as articulated within applicable contractor safety specifications. If a contractor or subcontractor has a health and safety standard or policy materially different from Enbridge's, the contractor/subcontractor shall follow the most stringent requirement. Contractors and subcontractors are still obligated to meet the requirements of all applicable laws related to this standard.

In the event a contractor's or subcontractor's standard exceeds the requirements of this standard, Enbridge may, in its sole discretion, choose to adopt the contractor's or subcontractor's standard for any given contract or work order.

## 3.0 PREREQUISITES

Hazard Assessment and Control Standard

## 4.0 DEFINITIONS & ACRONYMS

*Applicable Legislation* - All federal, provincial, state and municipal laws, regulations, codes, bylaws, ordinances or otherwise that are applicable to the jurisdiction in which the work is conducted including, but not limited to the Canada Labour Code, OSHA, State OSHA, Provincial and Territorial OH&S.

*Ceiling Occupational Exposure Limit* - An Exposure Limit which should not be exceeded at any time.

*Exposure Limit* - Workplace standard below which is believed that nearly all normal and healthy workers may be repeatedly exposed, day after day, for working lifetime without adverse health effects.

*GHS* – Globally Harmonized System (of classification and labelling of chemicals)

*Hazardous Materials Identification System (HMIS)* - A numerical hazard rating that incorporates the use of labels with color developed by the American Coatings Association as a compliance aid for the OSHA Hazard Communication (HazCom) Standard.

*HPR* - Hazardous Products Regulations

*NFPA* – National Fire Protection Association

*Permissible Exposure Limit (PEL)* - An occupational health standard instituted to safeguard workers against exposure to toxic material in the workplace.

*Person in Charge (PIC)* – The most senior ranking worker in the work area who has control over the work and activities of the work.

*PPE* – Personal Protective Equipment

*Safety Data Sheet (SDS)* - A Safety Data Sheet (SDS), previously called a Material Safety Data Sheet (MSDS), is a document that provides information on the properties of hazardous chemicals and advice about safety precautions.

*Short Term Exposure Limit (STEL)* - A 15-minute Time Weighted Average (TWA) exposure limit that should not be exceeded at any time during a workday even if the overall 8-hour TWA is within limits, and it should not occur more than 4 times per day. There should be at least 1 hour between successive exposures.

*Threshold Limit Value (TLV)* - Occupational exposure limit set by the American Conference of Governmental Industrial Hygienists (ACGIH) under which it is believed that nearly all Workers may be repeatedly exposed, day after day, over a working lifetime, without adverse health effects.

*Time Weighted Average (TWA) Exposure Limit* - The average exposure of a contaminant for an individual over a given working period determined by sampling at given times during the period. Unless otherwise mentioned, TWA is the concentration of contaminants measured over an 8-hour period.

*Workplace Hazardous Materials Information System (WHMIS)* - Canada's national hazard communication standard. The key elements of the system are hazard classification, cautionary labelling of containers, the provision of safety data sheets (SDSs) and worker education and training programs.

## 5.0 ROLES & RESPONSIBILITIES

People Leader shall:

- Maintain Facility Chemical Inventory in a location readily accessible to all employees and/or visitors.
- Review contractor work to determine what hazardous chemicals may be encountered by either the contractor or company employees.
- Ensure that PPE is provided as necessary to employees working with hazardous chemicals.
- Ensure that chemical containers on Company property are properly labeled.
- Assessing the method of control to ensure that OSHA PELs or ACGIH TLVs are not exceeded.

- Obtain and maintain SDS for all of the hazardous chemicals currently being used in their workplace.

Worker shall:

- Use appropriate PPE provided when working with hazardous chemicals.
- Review SDS for chemicals used in job tasks.
- Maintain good personal hygiene – Employee is responsible to wash exposed skin promptly to remove accidental splashes of hazardous material.
- Review the SDS before using a chemical for the first time.
- Ensure all hazardous chemicals used and stored in the workplace are properly labeled or marked.
- Ensure that the labels, markings and other forms of warning are:
  - Legible
  - In English (US)
  - In English and French (CAN)
  - Prominently displayed on the container

Safety Team shall:

- Provide timely advice, support and assistance to people leaders in the implementation of this standard, including the revision of new SDSs before using new hazardous chemicals in a facility,
- Perform spot checks on hazardous chemicals used and stored in the field to ensure field compliance to the standard, and
- Responsible for the maintenance and continuous improvement of this standard.

## **6.0 STANDARD-SPECIFIC REQUIREMENTS**

### **6.1 AVAILABILITY OF THE HCP**

Enbridge recognizes that a Hazard Communication Program (HCP) is made available and accessible to all employees. A list of known hazardous materials shall be available on request to any worker.

#### **6.1.1 NON-ROUTINE TASKS REQUIREMENT**

Before workers start a non-routine task which involves working with a hazardous material, the People Leader will provide the workers with information about the hazardous material to which they may be exposed to while performing the task.

This information should include at least the following:

**Uncontrolled Copy if Printed or Downloaded**

- A review of the SDS looking for the physical and health hazards of the hazardous material to be used.
- A review of the hazardous material exposure limits and a plan of action to limit exposure.

## **6.2 MULTI-EMPLOYER WORK SITES**

### **6.2.1 ENBRIDGE OBLIGATIONS TO CONTRACTORS**

During the contractor safety orientation, the PIC will provide the contractor employees with at least the following basic information:

- Location of the facility chemical list and SDS binder.
- Details of the labeling system used in the facility.
- Physical and health hazards of materials to which the contractor employees may be exposed to during normal operations.
- Any precautionary measures that need to be taken to protect contractor employees.
- Emergency and evacuation procedures.
- PPE required.
- Safe handling procedures.

### **6.2.2 CONTRACTOR OBLIGATIONS**

During the contractor safety orientation, the Contractor Supervisor will provide the PIC with at least the following basic information:

- Notification prior to bringing any hazardous materials on Company property.
- Copy of SDSs for any hazardous materials the contractor is bringing on site.
- The labeling system the contractor uses.
- Any precautionary measures that need to be taken to protect company employees.
- The safe storage and handling procedures the contractor will use.

A contractor cannot bring hazardous material containers onto company property unless those containers are properly labeled.

Any hazardous material brought onto the site by the contractor must be properly removed by the contractor. If a chemical brought by a contractor needs to stay on site, the SDS shall follow the chemical approval process.

### 6.3 HAZARDOUS CHEMICAL LIST (FACILITY CHEMICAL INVENTORY)

- Each facility shall develop and maintain a list of the hazardous chemicals known to be present in the workplace. This list of hazardous chemicals will become the Facility Chemical Inventory.
- The Facility Chemical Inventory shall be accessible to all employees.
- The Facility Chemical Inventory can be maintained electronically. At Enbridge, 3E Protect is the database system that houses the chemical inventory for the facility and the SDSs.
- The Facility Chemical Inventory should contain at the least the following basic information:
  - Chemical name
  - Chemical supplier name (phone number & address optional)
  - Chemical HMIS (US) hazard ratings or WHMIS (CAN) classification
- The chemical name used on the list should be the same name referenced on the SDS.
- Household products used for cleaning may be exempt from the inventory where/when they are used in the same manner (similar task, same amount of chemical, and same duration) as a consumer.
- The Facility Chemical Inventory should be reviewed and updated at least annually.
- Chemicals can be added to and removed from the list as needed for each facility.

### 6.4 SAFETY DATA SHEET (SDS) REQUIREMENTS

- The company relies on chemical manufacturers and distributors to provide SDS prior to or at the time chemicals are shipped to the company work places.
- The People Leader is responsible for obtaining and maintaining SDSs for all of the Facility Chemical Inventory being used in their workplace.
- If an SDS does not accompany a new chemical, the PIC must contact the vendor for immediate delivery of the SDS.
- New chemical SDSs will need to be added to the facility chemical inventory in 3E Protect.
- New chemical SDSs need to be reviewed and approved by H&S before first use in a facility.
- Employees must review the SDS before using a chemical for the first time.



- Employees should be familiar with all of the SDSs for the chemicals used in their work place.
- Electronic SDS or SDS binder must be accessible to workers at all times for all facilities.
- SDSs can be accessed on 3E Protect via mobile app or mobile browser.
- For field operations, where employees travel between workplaces, SDS binders may be kept at a manned field office so that in an emergency, the SDS information can be immediately obtained by radio or phone.
- When a location has an active laboratory stocked with hazardous chemicals, a separate SDS binder containing only the laboratory chemicals shall be easily accessible in the laboratory.
- When a chemical is no longer used in the workplace, the SDS must be archived for thirty (30) years.
- The company SDSs are provided and shall be maintained at the Enbridge workplaces that produce hazardous chemicals such as NGLs, condensate, LP commodities, etc. The company SDSs will be available in English and French for Canadian customers (CAN).
- SDSs shall be in English and French (CAN) and English (US) at a minimum and contain at least the following information about the chemical:
  - Chemical Name and Common Name used on the container label,
  - For mixtures, the Chemical Name and Common Name of each hazardous ingredient found in the chemical and its volume %,
  - Physical and chemical characteristics (vapor pressure, flash point, etc.),
  - Physical Hazards (flammable, reactive, corrosive, etc.),
  - Health Hazards (including signs and symptoms of exposure),
  - Primary routes of entry,
  - OSHA - PEL and the ACGIH – TLV,
  - Whether the material is a carcinogen,
  - Ecological Information,
  - Any generally applicable precautions such as during the clean-up of spills or releases,
  - Transport Information,
  - Regulatory Information,

- Any generally applicable control measures such as PPE,
- Emergency and First Aid procedures,
- Name, address and phone number of the chemical manufacture, and
- Date of the last SDS revision or update.
- SDSs shall be made available, upon request, to designated employee representatives and to OSHA.
- Appendices 11.1 and 11.2 provide more information about the SDS requirements by HMIS (US) and WHMIS (CAN).
- 3E Protect uses assigned roles for updating and approving new chemicals at each facility. These roles are:
  - Facility Manager (FM): this role is for users who are responsible for managing chemical inventories for one or more facilities. This person will be able to add/remove SDSs from the assigned facilities. This role is assigned to an individual by the facility Operations Supervisor.
  - Chemical Approval Manager (CAM): this individual is responsible for the approval of new products at the required facility. This role is assigned to the H&S Advisor supporting the specific facility.
  - Catalog Manager (CM): this person will provide rights to FMs and CAMs to specific facilities. This role is assigned to H&S Supervisors and OH (Occupational Hygiene) Advisors. Ops Supervisors will require FM credentials to their area CM. If facilities need to be added/removed from the system Operations Supervisors will require the CM to add/remove these facilities.

## **6.5 LABELS & WARNINGS REQUIREMENTS**

### **6.5.1 INCOMING HAZARDOUS CHEMICAL CONTAINERS**

- Chemical manufacturers or distributors shall provide, on each incoming container of hazardous chemical, an approved label or marking with the following:
  - Product Identifier
  - Signal Word
  - Hazard Statement(s)
  - Pictogram(s)
  - Precautionary Statement(s)
  - Name and address of the chemical manufacturer, importer or distributor.

- All incoming hazardous chemical containers should not be accepted in the workplace unless it is properly labeled and marked with the information listed above.
- The label, markings and placards provided by chemical manufacturers and distributors on incoming containers of hazardous chemical shall be utilized to meet the requirements of this section.
- Do not remove or deface labels, marking and placards on incoming hazardous chemical containers unless the container is sufficiently cleaned of residue and purged of vapors to remove any potential hazards.
- When the label and markings provided by chemical manufacturers or distributors become illegible, they shall be replaced with:
  - A new label provided by the chemical manufacture or distributor.
  - An in-house label or marking that is consistent with the SDS information.
- Appendices 11.1 and 11.2 provide more information about the SDS label requirements by HMIS (US) and WHMIS (CAN).

## **6.5.2 WORKPLACE (IN-HOUSE) CONTAINER LABELS & MARKINGS**

- Labels
  - The following labeling systems can be used to comply with the in-house labeling requirements:
    - Globally Harmonized System (GHS)
    - National Fire Protection Association (NFPA) (US)
    - Hazard Material Identification System (HMIS) (US) or WHMIS (CAN)
  - The chemical SDS can be used to determine the proper data to complete the GHS, HMIS and NFPA labels (US) and WHMIS labels (CAN)
  - Appendices 11.1 and 11.2 provide more information about the label requirements by HMIS (US) and WHMIS (CAN).
  - Workplace labels can be generated in 3E Protect system for SDSs in the system.

## **7.0 TRAINING**

Personnel working in the field must be knowledgeable in this Standard and may be assigned applicable training as driven by the Safety Training Matrix. Reference the Health & Safety training syllabi and matrices for further information and training re-certification requirements.

Workers who have been determined to have an occupational risk exposure to chemical hazards within their job role will be required to take Hazard Communication (US) or WHMIS (CAN) training.

Training is available for 3E Protect users, FMs, and CAMs.

## **8.0 RELATED DOCUMENTS**

Facility Chemical Inventory within 3E Protect

## **9.0 STANDARD REVIEW**

A subject matter expert (SME) will perform a technical review of this standard every two years to determine the accuracy of the content/information. The SME shall solicit input from applicable stakeholders to ensure the effectiveness of the standard. Any suggested changes must be reviewed and approved by the designated document owner.

## **10.0 REFERENCES**

The American Conference of Governmental Industrial Hygienists (ACGIH)

- Threshold Limit Values for Chemical Substances and Physical Agents

Canada Occupational Health and Safety Regulation (COHSR)

- Part X – Hazardous Substances

Department of Transportation (DOT)

- 49 CFR 100.185 Hazardous Materials Transportation

Hazardous Products Regulations (HPR)

National Fire Protection Agency (NFPA)

- Part 30 Flammable & Combustible Liquids Code

National Institute of Occupational Safety and Health (NIOSH)

- Pocket Guide to Hazardous Materials

Occupational Safety and Health Administration (OSHA)

- 29 CFR 1926.59 Hazard Communications
- 29 CFR 1910.1200 Hazard Communications
- 29 CFR 1910.1450 Hazardous Materials in Laboratories

Transportation of Dangerous Goods (TDG) Act and TDG Regulations

Workplace Hazardous Materials Information System (WHMIS) 2015 – News Hazardous Products Regulations Requirements, Hazardous Product Act and Hazardous Products Regulations

---

## 11.0 APPENDIX

### 11.1 HMIS AND NFPA SDS AND LABEL REQUIREMENTS (US)

#### 11.1.1 HAZARD COMMUNICATION SAFETY DATA SHEETS

The Hazard Communication Standard (HCS) requires chemical manufacturers, distributors, or importers to provide Safety Data Sheets (SDSs) (formerly known as Material Safety Data Sheets or MSDSs) to communicate the hazards of hazardous chemical products. As of June 1, 2015, the HCS requires new SDSs to be in a uniform format, and include the section numbers, the headings, and associated information under the headings below:









- Section 1, Identification includes product identifier; manufacturer or distributor name, address, phone number; emergency phone number; recommended use; restrictions on use.
- Section 2, Hazard(s) identification includes all hazards regarding the chemical; required label elements.
- Section 3, Composition/information on ingredients includes information on chemical ingredients; trade secret claims.
- Section 4, First-aid measures includes important symptoms/effects, acute, delayed; required treatment.
- Section 5, Fire-fighting measures lists suitable extinguishing techniques, equipment; chemical hazards from fire.
- Section 6, Accidental release measures lists emergency procedures; protective equipment; proper methods of containment and cleanup.
- Section 7, Handling and storage lists precautions for safe handling and storage, including incompatibilities.
- Section 8, Exposure controls/personal protection lists OSHA's Permissible Exposure Limits (PELs); ACGIH Threshold Limit Values (TLVs); and any other exposure limit used or recommended by the chemical manufacturer, importer, or employer preparing the SDS where available as well as appropriate engineering controls; personal protective equipment (PPE).
- Section 9, Physical and chemical properties lists the chemical's characteristics.
- Section 10, Stability and reactivity lists chemical stability and possibility of hazardous reactions.
- Section 11, Toxicological information includes routes of exposure; related symptoms, acute and chronic effects; numerical measures of toxicity.
- Section 12, Ecological information\*

- Section 13, Disposal considerations\*
- Section 14, Transport information\*
- Section 15, Regulatory information\*
- Section 16, Other information, includes the date of preparation or last revision.

\*Note: Since other Agencies regulate this information, OSHA will not be enforcing Sections 12 through 15 (29 CFR 1910.1200(g)(2)).

See Appendix D of 1910.1200 for a detailed description of SDS contents.

### 11.1.2 PICTOGRAMS AND HAZARDS

<p><b>Health Hazard</b></p>  <ul style="list-style-type: none"> <li>• Carcinogen</li> <li>• Mutagenicity</li> <li>• Reproductive Toxicity</li> <li>• Respiratory Sensitizer</li> <li>• Target Organ Toxicity</li> <li>• Aspiration Toxicity</li> </ul>	<p><b>Flame</b></p>  <ul style="list-style-type: none"> <li>• Flammables</li> <li>• Pyrophorics</li> <li>• Self-Heating</li> <li>• Emits Flammable Gas</li> <li>• Self-Reactives</li> <li>• Organic Peroxides</li> </ul>	<p><b>Exclamation Mark</b></p>  <ul style="list-style-type: none"> <li>• Irritant (skin and eye)</li> <li>• Skin Sensitizer</li> <li>• Acute Toxicity (harmful)</li> <li>• Narcotic Effects</li> <li>• Respiratory Tract Irritant</li> <li>• Hazardous to Ozone Layer (Non-Mandatory)</li> </ul>
<p><b>Gas Cylinder</b></p>  <ul style="list-style-type: none"> <li>• Gases Under Pressure</li> </ul>	<p><b>Corrosion</b></p>  <ul style="list-style-type: none"> <li>• Skin Corrosion/ Burns</li> <li>• Eye Damage</li> <li>• Corrosive to Metals</li> </ul>	<p><b>Exploding Bomb</b></p>  <ul style="list-style-type: none"> <li>• Explosives</li> <li>• Self-Reactives</li> <li>• Organic Peroxides</li> </ul>
<p><b>Flame Over Circle</b></p>  <ul style="list-style-type: none"> <li>• Oxidizers</li> </ul>	<p><b>Environment (Non-Mandatory)</b></p>  <ul style="list-style-type: none"> <li>• Aquatic Toxicity</li> </ul>	<p><b>Skull and Crossbones</b></p>  <ul style="list-style-type: none"> <li>• Acute Toxicity (fatal or toxic)</li> </ul>

### 11.1.3 HAZARD COMMUNICATION LABELS

OSHA has updated the requirements for labeling of hazardous chemicals under its Hazard Communication Standard (HCS). All labels are required to have pictograms, a signal word, hazard and precautionary statements, the product identifier, and supplier identification. A sample revised HCS label, identifying the required label elements, is shown below.

**SAMPLE LABEL**

**Product Identifier**

CODE \_\_\_\_\_  
Product Name \_\_\_\_\_

**Supplier Identification**

Company Name \_\_\_\_\_  
Street Address \_\_\_\_\_  
City \_\_\_\_\_ State \_\_\_\_\_  
Postal Code \_\_\_\_\_ Country \_\_\_\_\_  
Emergency Phone Number \_\_\_\_\_

**Precautionary Statements**

Keep container tightly closed. Store in a cool, well-ventilated place that is locked.  
Keep away from heat/sparks/open flame. No smoking.  
Only use non-sparking tools.  
Use explosion-proof electrical equipment.  
Take precautionary measures against static discharge.  
Ground and bond container and receiving equipment.  
Do not breathe vapors.  
Wear protective gloves.  
Do not eat, drink or smoke when using this product.  
Wash hands thoroughly after handling.  
Dispose of in accordance with local, regional, national, international regulations as specified.

**In Case of Fire:** use dry chemical (BC) or Carbon Dioxide (CO<sub>2</sub>) fire extinguisher to extinguish.

**First Aid**  
If exposed call Poison Center.  
If on skin (or hair): Take off immediately any contaminated clothing. Rinse skin with water.

**Hazard Pictograms**

**Signal Word**  
**Danger**

**Hazard Statements**

Highly flammable liquid and vapor.  
May cause liver and kidney damage.

**Supplemental Information**

**Directions for Use**

\_\_\_\_\_  
\_\_\_\_\_  
\_\_\_\_\_

Fill weight: \_\_\_\_\_ Lot Number: \_\_\_\_\_  
Gross weight: \_\_\_\_\_ Fill Date: \_\_\_\_\_  
Expiration Date: \_\_\_\_\_

**11.1.4 NFPA 704 & HMIS III RATING SYSTEMS CAN BE FOUND ON PRODUCT LABELS, SECONDARY LABELS AND SDS:**

Hazard	NFPA	HMIS® III	
<b>Flammability</b>	<b>4</b> a. Rapidly or completely vaporize under ambient conditions b. Readily dispersed in air c. Will burn readily	a. Flammable gases or very volatile liquids with flash point below 73°F & boiling point < 100 F b. May ignite spontaneously with air	
	<b>3</b> Ignited under ambient conditions	a. Capable of ignition under almost all ambient conditions b. Liquids with flash points below 73 °F & boiling points > 100 °F c. Liquids flash point 73 °F to 100 °F	
	<b>2</b> Must be moderately heated before ignition can occur	a. Moderately heated or exposed to high ambient temperatures before ignition b. Liquids flash point 100 °F to 200 °F	
	<b>1</b> Must be preheated before ignition can occur	a. Must be preheated before ignition b. Liquids, solids, semi solids with flash point >200°F	
	<b>0</b> Will not burn	Materials that will not burn	
<b>Health Hazard</b>	Concerned with acute health hazards only.	* Asterisk: if present indicates a chronic health hazard	
	<b>4</b> Under Emergency Conditions (UEC) can be lethal	a. Life-threatening b. Major or permanent damage may result from single or repeated overexposures	
	<b>3</b> UEC can cause serious or permanent injury	Major injury likely unless prompt action is taken and medical treatment is given	
	<b>2</b> UEC can cause temporary incapacitation or residual injury	Temporary or minor injury may occur	
	<b>1</b> UEC can cause severe irritation	Irritation or minor reversible injury possible	
	<b>0</b> UEC would offer no hazard beyond ordinary combustible materials	No significant risk to health	
<b>Reactivity (NFPA)</b>	<b>4</b> a. Capable of detonation b. Explosive decomposition c. Explosive reaction at normal temperatures & pressures	<b>Physical Hazard (HMIS® III)</b>	<b>4</b> a. Explosive water reaction b. Detonation or explosive decomposition, polymerization c. Self-reaction at ambient conditions
	<b>3</b> a. Capable of detonation b. Explosive decomposition c. Explosive reaction with strong initiation source or heated under confinement		<b>3</b> a. May form explosive mixture in water b. Detonation or explosive reaction in the presence of strong initiating source c. May polymerize, decompose, self-react d. May undergo chemical change at ambient with moderate risk of explosion
	<b>2</b> Violent chemical change at elevated temperatures & pressures		<b>2</b> a. Unstable and may undergo violent chemical changes at ambient with low risk for explosion b. May react violently with water. c. May form peroxides upon exposure to air
	<b>1</b> Unstable at elevated temperatures		<b>1</b> a. Can become unstable at high temperature & pressure b. May react non-violently with water c. May undergo hazardous polymerization in absence of inhibitors
	<b>0</b> Normally stable even under fire conditions		<b>0</b> a. Normally stable, even under fire b. Will not react with water, polymerize, decompose, condense, or self-react



### 11.1.5 SPECIAL HANDLING & PERSONAL PROTECTION

	NFPA Special Handling		HMIS® III Personal Protection				
	Special Handling & Personal Protection	OX	Oxidizer	A	Safety Glasses		
B				Safety Glasses	Gloves		
ACID		Acid	C	Safety Glasses	Gloves	Protective Apron	
			D	Face Shield	Gloves	Protective Apron	
ALK		Alkali	E	Safety Glasses	Gloves	Dust Respirator	
			F	Safety Glasses	Gloves	Protective Apron	Dust Respirator
COR		Corrosive	G	Safety Glasses	Gloves	Vapor Respirator	Hand Washing
			H	Splash Goggles	Gloves	Protective Apron	Vapor Respirator
			I	Safety Glasses	Gloves	Dust Respirator	Vapor Respirator
W		Use no water	J	Splash Goggles	Gloves	Protective Apron	Dust Respirator
			K	Air Line Mask or Hood	Gloves	Full Suit	Boots
			Ask your Supervisor for special handling instructions				

## 11.2 WHMIS SDS AND LABEL REQUIREMENTS (CAN)

### 11.2.1 HPR SPECIFIES THE SECTIONS AND CONTENT FOR THE SDS AS FOLLOWS:

SDS Section and Heading		Specific Information Elements
1	Identification	<ul style="list-style-type: none"> <li>• Product identifier (e.g. Product name)</li> <li>• Other means of identification (e.g. product family, synonyms, etc.)</li> <li>• Recommended use</li> <li>• Restrictions on use</li> <li>• Canadian supplier identifier+               <ul style="list-style-type: none"> <li>○ Name, full address and phone number(s)</li> </ul> </li> <li>• Emergency telephone number and any restrictions on the use of that number, if applicable</li> </ul>
2	Hazard identification	<ul style="list-style-type: none"> <li>• Hazard classification (class, category) of substance or mixture or a description of the identified hazard for Physical or Health Hazards Not Otherwise Classified</li> <li>• Label elements:               <ul style="list-style-type: none"> <li>○ Symbol (image) or the name of the symbol (e.g., flame, skull and crossbones)</li> <li>○ Signal word</li> <li>○ Hazard statement(s)</li> <li>○ Precautionary statement(s)</li> </ul> </li> <li>• Other hazards which do not result in classification (e.g., molten metal hazard)</li> </ul>
3	Composition/Information on ingredients	<ul style="list-style-type: none"> <li>• When a hazardous product is a material or substance:               <ul style="list-style-type: none"> <li>○ Chemical name</li> <li>○ Common name and synonyms</li> <li>○ Chemical Abstract Service (CAS) registry number and any unique identifiers</li> <li>○ Chemical name of impurities, stabilizing solvents and/or additives*</li> </ul> </li> <li>• For each material or substance in a mixture that is classified in a health hazard class**:</li> <li>○ Chemical name</li> <li>○ Common name and synonyms</li> <li>○ CAS registry number and any unique identifiers</li> <li>○ Concentration</li> </ul> <p>NOTE: Confidential business information rules can apply</p>
4	First-aid measures	<ul style="list-style-type: none"> <li>• First-aid measures by route of exposure:               <ul style="list-style-type: none"> <li>○ Inhalation</li> <li>○ Skin contact</li> <li>○ Eye contact</li> <li>○ Ingestion</li> </ul> </li> <li>• Most important symptoms and effects (acute or delayed)</li> <li>• Immediate medical attention and special treatment, if necessary</li> </ul>
5	Fire-fighting measures	<ul style="list-style-type: none"> <li>• Suitable extinguishing media</li> <li>• Unsuitable extinguishing media</li> </ul>

		<ul style="list-style-type: none"> <li>• Specific hazards arising from the hazardous product (e.g., hazardous combustion products)</li> <li>• Special protective equipment and precautions for fire-fighters</li> </ul>
6	Accidental release measures	<ul style="list-style-type: none"> <li>• Personal precautions, protective equipment and emergency procedures</li> <li>• Methods and materials for containment and cleaning up</li> </ul>
7	Handling and storage	<ul style="list-style-type: none"> <li>• Precautions for safe handling</li> <li>• Conditions for safe storage (including incompatible materials)</li> </ul>
8	Exposure controls/ Personal protection	<ul style="list-style-type: none"> <li>• Control parameters, including occupational exposure guidelines or biological exposure limits and the source of those values</li> <li>• Appropriate engineering controls</li> <li>• Individual protection measures (e.g. personal protective equipment)</li> </ul>
9	Physical and chemical properties	<ul style="list-style-type: none"> <li>• Appearance (physical state, colour, etc.)</li> <li>• Odour</li> <li>• Odour threshold</li> <li>• pH</li> <li>• Melting point/Freezing point</li> <li>• Initial boiling point/boiling range</li> <li>• Flash point</li> <li>• Evaporation rate</li> <li>• Flammability (solid; gas)</li> <li>• Lower flammable/explosive limit</li> <li>• Upper flammable/explosive limit</li> <li>• Vapour pressure</li> <li>• Vapour density</li> <li>• Relative density</li> <li>• Solubility</li> <li>• Partition coefficient - n-octanol/water</li> <li>• Auto-ignition temperature</li> <li>• Decomposition temperature</li> <li>• Viscosity</li> </ul>
10	Stability and reactivity	<ul style="list-style-type: none"> <li>• Reactivity</li> <li>• Chemical stability</li> <li>• Possibility of hazardous reactions</li> <li>• Conditions to avoid (e.g., static discharge, shock, or vibration)</li> <li>• Incompatible materials</li> <li>• Hazardous decomposition products</li> </ul>
11	Toxicological information	<p>Concise but complete description of the various toxic health effects and the data used to identify those effects, including:</p> <ul style="list-style-type: none"> <li>• Information on the likely routes of exposure (inhalation, ingestion, skin and eye contact)</li> <li>• Symptoms related to the physical, chemical and toxicological characteristics</li> <li>• Delayed and immediate effects, and chronic effects from short-term and long-term exposure</li> <li>• Numerical measures of toxicity</li> </ul>
12	Ecological information***	<ul style="list-style-type: none"> <li>• Ecotoxicity</li> <li>• Persistence and degradability</li> <li>• Bioaccumulative potential</li> </ul>

		<ul style="list-style-type: none"> <li>• Mobility in soil</li> <li>• Other adverse effects</li> </ul>
13	Disposal considerations***	Information on safe handling for disposal and methods of disposal, including any contaminated packaging
14	Transport information***	<ul style="list-style-type: none"> <li>• UN number</li> <li>• UN proper shipping name</li> <li>• Transport hazard class(es)</li> <li>• Packing group</li> <li>• Environmental hazards</li> <li>• Transport in bulk, if applicable</li> <li>• Special precautions</li> </ul>
15	Regulatory information***	Safety, health and environmental regulations specific to the product
16	Other information	Date of the latest revision of the SDS

+The supplier that must be identified on an SDS is the initial supplier identifier (i.e., the name, address and telephone number of either the Canadian manufacturer or the Canadian importer). There are two exceptions to this requirement. In a situation where a hazardous product is being sold by a distributor, the distributor may replace the name, address and telephone number of the initial supplier with their own contact information. In a situation where an importer imports a hazardous product for use in their own workplace in Canada (i.e., the importer is not selling the hazardous product), the importer may retain the name, address and telephone number of the foreign supplier on the SDS instead of replacing it with their own contact information.

\*These impurities and stabilizing products are those that are classified in a health hazard class and contribute to the classification of the material or substance.

\*\*Each ingredient in the mixture must be listed when it is classified in a health hazard class and is present above the concentration limit that is designated for the hazard class in which it is classified or is present in the mixture at a concentration that results in the mixture being classified in any health hazard class.

\*\*\*Sections 12 to 15 require the headings to be present, but under Canadian regulations, the supplier has the option to not provide information in these sections.

## 11.2.2 PICTOGRAMS AND HAZARDS

Pictograms are graphic images that immediately show the user of a hazardous product what type of hazard is present. With a quick glance, you can see, for example, that the product is flammable, or if it might be a health hazard.

Most pictograms have a distinctive red "square set on one of its points" border. Inside this border is a symbol that represents the potential hazard (e.g., fire, health hazard, corrosive, etc.). Together, the symbol and the border are referred to as a pictogram. Pictograms are assigned to specific hazard classes or categories.

The graphic below shows hazard pictograms. The bold type is the name given to the pictogram; the words in the brackets describe the hazard.

	<b>Exploding bomb</b> (for explosion or reactivity hazards)		<b>Flame</b> (for fire hazards)		<b>Flame over circle</b> (for oxidizing hazards)
	<b>Gas cylinder</b> (for gases under pressure)		<b>Corrosion</b> (for corrosive damage to metals, as well as skin, eyes)		<b>Skull and Crossbones</b> (can cause death or toxicity with short exposure to small amounts)
	<b>Health hazard</b> (may cause or suspected of causing serious health effects)		<b>Exclamation mark</b> (may cause less serious health effects or damage the ozone layer*)		<b>Environment*</b> (may cause damage to the aquatic environment)
	<b>Biohazardous Infectious Materials</b> (for organisms or toxins that can cause diseases in people or animals)				

\* The GHS system also defines an Environmental hazards group. This group (and its classes) was not adopted in WHMIS 2015. However, you may see the environmental classes listed on labels and Safety Data Sheets (SDSs). Including information about environmental hazards is allowed by WHMIS 2015.

### 11.2.3 SUPPLIER LABELS

Supplier labels must be written in English and French. They may be bilingual (as one label), or available as two labels (one each in English and French).

The supplier label must include the following information:

1. **Product identifier** – the brand name, chemical name, common name, generic name or trade name of the hazardous product.
2. **Initial supplier identifier** – the name, address and telephone number of either the Canadian manufacturer or the Canadian importer\*.
3. **Pictogram(s)** – hazard symbol within a red "square set on one of its points".
4. **Signal word** – a word used to alert the reader to a potential hazard and to indicate the severity of the hazard.
5. **Hazard statement(s)** – standardized phrases which describe the nature of the hazard posed by a hazardous product.
6. **Precautionary statement(s)** – standardized phrases that describe measures to be taken to minimize or prevent adverse effects resulting from exposure to a hazardous product or resulting from improper handling or storage of a hazardous product.
7. **Supplemental label information** – some supplemental label information is required based on the classification of the product. For example, the label for a mixture containing ingredients with unknown toxicity in amounts higher than or equal to 1% must include a statement indicating the percent of the ingredient or ingredients with unknown toxicity. Labels may also include supplementary information about precautionary actions, hazards not yet included in the GHS, physical state, or route of exposure. This information must not contradict or detract from the standardized information.

\* Initial supplier identifier – There are two exceptions to this requirement:

- In a situation where a hazardous product is being sold by a distributor, the distributor may replace the name, address and telephone number of the initial supplier with their own contact information.
- In a situation where an importer imports a hazardous product for use in their own workplace in Canada (i.e., the importer is not selling the hazardous product), the importer may retain the name, address and telephone number of the foreign supplier on the SDS instead of replacing it with their own contact information.

11.2.4 AN EXAMPLE OF A BILINGUAL LABEL IS SHOWN BELOW:



Workplace label will require the following information:

- Product name (matching the SDS product name).
- Safe handling precautions, may include pictograms or other supplier label information.
- A reference to the SDS (if available).

Workplace label requirements fall under your provincial or territorial jurisdiction, or under the Canada Labour Code if you work in a federally regulated workplace. Again, watch for confirmation, updates, or changes to these requirements when the WHMIS regulations in your jurisdiction are updated.

---

## CHANGE LOG

Section	Version 2.0	Version 2.1
Entire document		Clerical corrections including spelling, grammar, and document names.

<End of Document>





---

# Standard

---

## Hoisting and Rigging

---

**Effective Date:** 2019-03-30  
**Version #:** 1.5  
**Version Date:** 2024-03-27

---



This page intentionally left blank



Document Version Register

Version Number	Version Date	Approved By	Section Number and Title	Details of Version
1.0	2019-03-30	Sean Evans	Whole Document (New Standard)	This is the new H&S standard that was developed as part of the LP   MP Safety Manual Transition Project
1.1	2019-10-31	Sean Evans	4.0, 5.0, 6.1.4	See Change Log
1.2	2020-06-01	Sean Evans	2.0	Alignment with Contractor Safety Specifications
1.3	2021-03-01	Murray Evenson	8.0	Added 'Related Documents'
1.4	2021-12-01	Murray Evenson	9.0	Updated section 9 to reflect the appropriate review process
1.5	2024-03-27	Troy Croft	All sections	Clerical corrections

Uncontrolled Copy if Printed or Downloaded



This page intentionally left blank

---

## **Table of Contents**

1.0	Purpose .....	3
2.0	Scope .....	3
3.0	Prerequisites.....	3
4.0	Definitions & Acronyms .....	3
5.0	Roles & Responsibilities .....	4
6.0	Standard-Specific Requirements .....	5
6.1	Classification of Lifts .....	6
6.1.1	Critical Lifts .....	6
6.1.2	Engineered Critical Lifts.....	7
6.1.3	Serious Lift.....	7
6.1.4	Standard Lifts.....	7
6.2	Lift Planning .....	8
6.3	Lift Requirements .....	9
6.4	Rigging and Hoisting Requirements .....	9
6.5	Inspection and Maintenance.....	10
6.6	Lifting and Support Component Requirements and Formal Inspection .....	11
6.6.1	Blocking and Cribbing.....	11
6.6.2	Hooks.....	11
6.6.3	Slings, Chains, Ropes, Cables .....	12
6.6.4	Hoist Chains .....	13
6.6.5	Taglines .....	13
6.6.6	Jacks.....	13



---

7.0	Training Requirements .....	14
8.0	Related Documents .....	14
9.0	Standard Review .....	15
10.0	References .....	15
11.0	Appendix.....	16
11.1	Lift Plan.....	16
11.2	Lift Data Sheet.....	17
11.3	Critical Lift Plan Form .....	18
11.4	Pre-Lift Safety Checklist .....	19
	Change Log.....	20

## 1.0 PURPOSE

To ensure the safety of Enbridge workers and contractors and provide a guideline for approved hoisting and rigging practices within Enbridge.

## 2.0 SCOPE

This standard applies to LP Operations and Projects being completed for LP.

Contractors and subcontractors shall comply with Enbridge health and safety requirements set out in this standard, as articulated within applicable contractor safety specifications. If a contractor or subcontractor has a health and safety standard or policy materially different from Enbridge's, the contractor/subcontractor shall follow the most stringent requirement. Contractors and subcontractors are still obligated to meet the requirements of all applicable laws related to this standard.

In the event a contractor's or subcontractor's standard exceeds the requirements of this standard, Enbridge may, in its sole discretion, choose to adopt the contractor's or subcontractor's standard for any given contract or work order.

## 3.0 PREREQUISITES

Hazard Assessment, Elimination and Control Standard

Powered Mobile Equipment Standard

Safe Work Permit and Work Authorization Standard

Vehicle Operations Standard

## 4.0 DEFINITIONS & ACRONYMS

*CLP* – Critical Lift Plan

*Competent worker*—Means one who is capable of identifying existing and predictable hazards in the surroundings or working conditions which are unsanitary, hazardous, or dangerous to employees, and who has authorization to take prompt corrective measures to eliminate them.

*ECLP* – Engineered Critical Lift Plan

*FLHA* – Field Level Hazard Assessment

*High Voltage*—Over 750 volts [CAN] or over 600 volts [USA].

*JHA* – Job Hazard Assessment

*Lift Coordinator*—The person designated to direct the overall work scope.

*Lift Plan*—Information and/or instruction used in support of a load handling activity.

*Lift*—To hoist, lower and horizontally move a suspended load.

*Load Handling Equipment (LHE)*—Equipment used to move a load.

*PPE* – Personal Protective Equipment

*Qualified Lift Engineer*—Responsible for providing any required engineering support and documentation for the load handling activity (generally provided by the contractor).

*Qualified*—one who, by possession of a recognized degree, certificate, or professional standing, or who by knowledge, training and experience, has successfully demonstrated his ability to solve or resolve problems relating to the subject matter, the work, or the project.

*SLP* – Serious Lift Plan

*Working Load Limit (WLL)*—is the maximum working load specified by the manufacturer.

## 5.0 ROLES & RESPONSIBILITIES

People Leaders shall:

- Ensure that employees and contractors are aware of and comply with this standard;
- Perform spot checks to ensure field compliance of the standard; and
- Assign appropriate individuals to rigging and hoisting activities.

Qualified operators shall:

- Be trained with the LHE they are about to operate;
- Ensure procedures applicable to the operation of the equipment are readily available in the cab at all times;
- Ensure a permanently-attached load and radius chart can be easily read from their operating position;
- Verify weight of the load (including load and rigging);
- Have experience consistent with the requirements of the lift to be made;
- Be qualified for their task;
- Provide documentation of training records and certifications upon request; and
- Assign appropriate individuals to rigging and hoisting activities.

Qualified rigger/rigging specialists shall:

- Be trained as per applicable legislation;
- Have experience consistent with the requirements of the lift to be made;
- Be competent for their task;



- Provide documentation of training records and certifications upon request;
- Perform equipment inspections, as per manufacturer's specifications, to verify that the lifting device and all components are in safe working condition.
- Maintain a written record or logbook of these inspections.
- Note: A Qualified Operator shall be used in jurisdictions that don't certify riggers.

Signalers shall:

- Be qualified in hoisting and rigging hand signals;
- Complete any specific training required by applicable legislation and/or as required by the company in charge of the lift;
- Wear appropriate PPE to distinguish themselves from other workers (e.g. gauntlet);
- Halt operations if a person enters an area under a suspended lift/ enters area between a stationary object and a suspended load; and
- Observe and communicate on the movement of the LHE and load.

Lift Coordinators shall:

- Be the qualified person in charge of the lift; and
- Facilitate all pre-lift meetings for serious and critical lifts.

Safety Team shall:

- Provide timely advice, support and assistance to people leaders in the implementation of this standard; and
- Perform spot checks to ensure field compliance to the Safety Standards.

Safety shared services shall:

- Be responsible for the maintenance and continuous improvement of this standard.

## **6.0 STANDARD-SPECIFIC REQUIREMENTS**

When hoisting, lowering or moving a load vertically or horizontally with the LHE, the following factors shall be considered or determined:

- Percent of equipment capacity;
- Weight of the load;
- Any change or transition of critical workers, as identified in the lift plan;
- Ground conditions;
- Compaction of soil;

- Overhead lines, obstructions, etc.;
- Underground facilities or hazards;
- Trajectory of load if dropped (i.e., determine the potential drop zone);
- Electrical equipment in the area, e.g., nearby conductors or overhead power lines;
- Weather conditions;
- Outrigger and track loading;
- Matting;
- Process operations and local process hazards;
- Workers near the lift area; and
- Multi-lift plans.

Controls shall be identified based on the conditions determined given the circumstances of the lift to be performed.

## **6.1 CLASSIFICATION OF LIFTS**

Lifts shall be classified in the following types to determine the requirements for controls:

- Critical;
- Serious; and
- Standard.

### **6.1.1 CRITICAL LIFTS**

The workers involved in a critical lift shall apply the required controls and any other appropriate measures to ensure the safe and effective execution of the lift.

Lifts classified as critical lifts include:

- Any LHE lift, when the load is greater than 75% of the manufacturer's rating chart;
- Any tandem lift (multi-LHE lift) involving two or more LHE lifting the same load simultaneously, when the load may exceed more than 75% of the lifting capacity of any one LHE, as measured on the manufacturer's rating chart; and
- Any lift where the load travels over or between overhead High Voltage power lines (this does not include cables in cable trays).

The minimum control measure required for all critical lifts is the completion of a critical lift plan (CLP).

The CLP shall be signed and approved by a qualified rigger/rigging specialist and/ or qualified equipment operator.

### 6.1.2 ENGINEERED CRITICAL LIFTS

An engineered critical lift plan (ECLP) may be used based on the level of risk identified in the hazard assessment by the regional manager/project manager in consultation with the contractor.

A qualified lift engineer shall visit the site of the lift to familiarize themselves with all above and below grade facilities in order to create a comprehensive engineered critical lift plan.

The ECLP shall be reviewed and agreed to by all workers involved in the lift at the pre-lift meeting. The ECLP shall be signed and approved by a qualified equipment operator and a qualified rigger/rigging specialist (when applicable).

### 6.1.3 SERIOUS LIFT

The workers involved in a serious lift shall apply the required controls and any other appropriate measures to ensure the safe and effective execution of the lift.

Lifts classified as serious lifts include any:

- Crane lift where workers are being hoisted in a man-basket;
- Lift where failure of the lift could endanger existing facilities or one-of-a-kind equipment or processes;
- Load where non-routine lifting or rigging equipment configurations are used;
- Lift where the load or any part of the LHE could come within the safe limits of approach to High Voltage equipment or a power line;
- Lifts over existing permanent structures; or
- Blind lift.

For each serious lift, the minimum control measure required shall be completion of a serious lift plan (SLP).

### 6.1.4 STANDARD LIFTS

A standard lift is any lift that is not classified as serious or critical. Details around the lift shall be documented on a hazard assessment (JHA and/ or FLHA) and discussed with workers involved in the lift.

The details documented should include:

- Records of weight,
- Radius, and

- Percentage of load chart for each lift, or for a series of lifts from a single location (as applicable).

## 6.2 LIFT PLANNING

For serious and critical lifts, the minimum control measure required shall be completion of a lift plan. The lift plan shall be reviewed, agreed to, and signed off by all workers involved in the lift at the pre-lift meeting.

At a minimum, the information recorded on the serious or critical lift plan shall include:

- Weight;
- Radius;
- Equipment type;
- Percentage of load chart;
- Rigging components;
- Rating capacities; and
- Adequate clearances to prevent contact with site-specific hazard(s) or obstructions during load handling activities.

In addition to the requirements of the Serious Lift Plan, the CLP shall include:

- Equipment layout and swing path schematic;
- Rig arrangement schematic; and
- Lift sequence.

A pre-lift meeting shall be held for all serious and critical lifts. At a minimum, the pre-lift meeting shall review:

- The lift plan with all parties involved with the lift;
- Identified traveled path(s) of the load and LHE;
- Hazards and controls associated with the work area;
- Identification of the Qualified Rigger (when applicable) and signaler to other workers involved;
- Agreed upon lift hand signals;
- Agreed upon means of communication between the operator and signaler if the equipment operator cannot see the load or the signaler (if applicable);
- Identified and marked the swing radius (if applicable);
- The lift zone and all potential drop zones;

- The requirement to not walk or pass under a suspended load or enter the area between the load and a stationary object; and
- Complete the pre-lift checklist (located in the appendix) for serious or critical lifts.

Note: Multiple lift rigging, commonly known as “Christmas-tree” lifting shall not be performed at Enbridge locations.

### **6.3 LIFT REQUIREMENTS**

When performing any lift, the lift coordinator and operator shall:

- Ensure barricades and warning signs are in place to control traffic in the work area;
- Ensure warning tape or an exclusion zone is made around the swing radius of the counter weight;
- Ensure loads are not moved, carried or swung over the head of any worker;
- Avoid traveling with loads suspended. If travel is necessary, ensure loads are secured to control the load swing (i.e., taglines used);
- Keep loads as close to the ground as reasonably possible;
- Ensure the operator remains at the controls while loads are suspended;
- Ensure a safe distance from the load is maintained until the tension on the rigging is relaxed and the load is stable;
- Ensure all workers are clear of the load being lifted;
- Stop all operations if someone enters the area under a suspended load/ area between a stationary object and a suspended load; and
- Stabilize the load and assess and mitigate the hazards to allow for final fit-up by hand if required.

All workers involved in the lift have the responsibility to suspend operations when any of the following occur:

- The wind velocity exceeds the crane’s limit specified by the manufacturer;
- The ambient temperature is below that specified by the manufacturer;
- Severe environmental conditions are present; or
- Any other hazard creates an unsafe working condition.

### **6.4 RIGGING AND HOISTING REQUIREMENTS**

Qualified operator shall ensure that all rigging and hoisting meet the following requirements:

- All lifting devices and components shall be of sufficient size and strength to support the weight of the load, and that they do not exceed the manufacturer's recommendations under any circumstances;
- Kept in good working order in accordance with manufacturer's specifications;
- Used in accordance with manufacturer's specifications;
- Ensure the hoist is free to swivel on hooks;
- Rig loads over 3.6 m (12 ft.) long at a minimum of 2 points, more points may be required depending on load distribution and load shape;
- Attach the load to the hook by slings or other approved lifting devices;
- Set up to rig the hoist directly over the load based on centre of gravity of the load;
- The working load limit (WLL) of the hoist shall not exceed the WLL of the foundation and structural supports that the equipment is on;
- The load chain or hoist cable is free from kinks and twists, and is not wrapped around the load;
- All lifting devices shall be properly assembled using the appropriate rigging component as required for the intended lift (e.g., four-part line vs. a two-part line);
- The load, sling, lifting device and load block shall clear all obstructions;
- Ensure equipment (e.g., boom) stays within the safe limits of approach to electrical lines and conductors, in accordance with the hazard assessment and/or lift plan;
- A test lift is conducted to assess the center of gravity so that the rigging can be re-positioned as needed;
- All hoisting lines shall be placed in a vertical position over the centre of gravity, in such a manner as to reduce danger to workers from a swing or uncontrolled movement of the load. Dynamic loading impacts the capacity of the crane; and
- Tension is maintained on the rigging and that the rigging is not unhooked until the load is fully secured.

Material lifting structures, hoists and rigging components shall be clearly marked with the WLL.

Markings shall:

- Be legible and visible on the LHE; and
- Be in contrasting color to the LHE.

## 6.5 INSPECTION AND MAINTENANCE

All LHE shall be installed, operated, inspected, maintained and repaired according to the manufacturer's specifications.

A written inspection and maintenance program for LHE shall be in place to ensure that equipment and components are in safe operating condition.

All load bearing components shall undergo non-destructive testing in accordance with the manufacturer's specifications.

Equipment shall be inspected before each lift.

Follow these additional maintenance and inspection requirements:

- The manufacturer's specifications shall be followed when assembling/disassembling equipment, under the direction of a qualified worker;
- Modifications or additions that may affect the capacity or safe operation of the equipment shall be made only with the written approval of the manufacturer; and
- Inspection records are required for each lifting device.

All written records including all certifications, maintenance records, and inspection records for LHE, e.g., cranes, hoists, and side booms shall be made available to an Enbridge representative for review upon request.

## **6.6 LIFTING AND SUPPORT COMPONENT REQUIREMENTS AND FORMAL INSPECTION**

Lifting components shall be kept in good working order and a formal inspection completed in accordance with manufacturer's specifications by a person qualified to complete the inspection. All components found to be deficient or defective shall be tagged and removed from service.

### **6.6.1 BLOCKING AND CRIBBING**

When blocking and cribbing, workers shall:

- Use appropriate materials for cribbing;
- Use solid layers of timber for heavy loads;
- As needed, use steel or hardwood mats under cribbing to spread the bearing pressure evenly (e.g., if the ground has insufficient load bearing capabilities);
- Use load-rated manufactured pipe support; and
- Ensure stability in cribbing:
  - The height of cribbing should not exceed the length of the cribbing material.

### **6.6.2 HOOKS**

Hooks shall not be overloaded. All hooks used for lifting shall have a safety latch.

The hooks' safety latch shall:

- Be closed, and shall not support any part of the load;
- Not be damaged or bent;
- Operate with enough spring pressure to keep the latch tightly secured against the top of the hook; and
- Spring back to the top when released.

Approved pipe hooks (sorting hooks) that are designed without safety latches are exempt from the requirements outlined immediately above.

Replace hooks (including the nut) if any of the following conditions are observed:

- Cracking;
- Excessive wear/deformities/twisting;
- Throat opening; and
- Twist out of the normal hook plane.

### 6.6.3 SLINGS, CHAINS, ROPES, CABLES

Slings (including rope and cable slings) used for lifts shall:

- Have softeners added where sharp corners contact the sling;
- Be at a 45° angle or more;
- Be flat (i.e., not twisted, kinked or knotted) while in use;
- Be connected in a way that provides control of the load;
- Avoid shock loading;
- Not be drug on the floor or over abrasive surfaces;
- Not be pulled from under a load when the load is resting on the sling;
- Be stored out of the elements (sunlight, rain, snow, etc.) and in accordance with manufacturers' specifications;
- Be the correct size for the hook and shall be seated in the saddle of the hook; and
- Be inspected, used and stored according to the manufacturer's specifications.

A competent worker shall visually inspect slings before use. The worker shall also ensure slings and accessories:



- Have not been damaged in storage or shipment;
- Are clearly labeled and/or tagged;
- Are rated for hoisting, indicating the manufacturer's ratings and the safe working limits;
- Are the correct type and have the proper capacity rating for the application; and
- Are removed from service and discarded if they're defective or are showing signs of damage or excessive wear.

#### 6.6.4 HOIST CHAINS

Hoist chains shall have a name plate with all relevant information legible and shall be used and inspected as per manufacturers' specifications. Chains used for overhead lifting shall be Grade 80 or better. Welded chains shall not be used. A competent worker shall inspect the chains link by link for:

- Nicks;
- Gouges;
- Twisted links; and
- Excessive wear or stretching.

#### 6.6.5 TAGLINES

Taglines shall be used to protect workers from being in the line of fire while allowing them the ability to manipulate the load from a safe distance. As such, tag lines shall be attached when rotation or swinging of the load is hazardous, or when the load needs guidance.

Multiple tag lines may be used when rotation or uncontrolled motion of a load being hoisted is anticipated.

At a minimum, tag lines shall:

- Be inspected before each lift and removed from service if defective; and
- Be attached directly to the load.

During the lift, tag lines shall not:

- Be used if they create an unsafe condition as determined by the hazard assessment; and
- Be wrapped or secured in any form to a worker.

#### 6.6.6 JACKS

Jacks shall:

- Only be used for temporary support of loads;
- Be supported by a firm level foundation;
- Not be used at an angle; and
- Lift loads from one end at a time, not from side to side.

External hydraulic jack pumps shall be positioned a safe distance from the load being lifted.

Discard or repair jacks if visual inspection reveals any of the following:

- Hydraulic fluid leaks;
- Thread damage;
- Scoring or other damage to the ram;
- Excessively loose or frozen swivel heads;
- Damaged end caps;
- Cracks or other damage to the housing; or
- Loose bolts or rivets.

## **7.0 TRAINING REQUIREMENTS**

Personnel working in the field must be knowledgeable in this Standard and may be assigned applicable training as driven by the Safety Training Matrix.

Reference the Health & Safety training syllabi and matrices for further information and training re-certification requirements.

## **8.0 RELATED DOCUMENTS**

- Boom/Picker Truck Pre-Use Inspection
- Crane Pre-Use Inspection
- Lift/Critical Lift Form
- Lifting Equipment Inspection
- Pre-Lift Checklist
- Safe Work Permit
- Sling Inventory
- Zoom Boom Inspection

---

## 9.0 STANDARD REVIEW

A subject matter expert (SME) will perform a technical review of this standard every two years to determine the accuracy of the content/information. The SME shall solicit input from applicable stakeholders to ensure the effectiveness of the standard. Any suggested changes must be reviewed and approved by the designated document owner.

## 10.0 REFERENCES

### OSHA Standards

- Part 1910.176 Handling materials - general.
- Part 1910.184 Slings.
- Part 1926 - Safety and Health Regulations for Construction
- Part 1926.251 Rigging equipment for material handling

### Canada Labour Code, Part II:

- Canadian Occupational Safety & Health (COSH) regulations, Part XIV Materials Handling

ASME Standard P30.1, Planning for Load Handling Activities

# 11.0 APPENDIX

## 11.1 LIFT PLAN

	<b>LIFT PLAN</b>	
--	------------------	--

Location on job / lift description: \_\_\_\_\_

Date of lift: \_\_\_\_\_ Project # \_\_\_\_\_ Type of LHE \_\_\_\_\_

Manufacturer \_\_\_\_\_ Model# \_\_\_\_\_ Type of LHE \_\_\_\_\_

**LHE CHECKS**

Any deviation from level compact surface in area? \_\_\_\_\_

Electrical hazards in the area? \_\_\_\_\_

Obstacles or obstructions to lift and swing? \_\_\_\_\_

Swing direction and degree (boom swing) \_\_\_\_\_

LHE inspected by: \_\_\_\_\_

Functional test of LHE by: \_\_\_\_\_

LIFT ARRANGEMENT	PLANNED LIFT PATH	JIB
Lift radius _____ ft. (center pin of crane to center of lift)	[ ] 360° [ ] over front [ ] over rear [ ] over side	Erected [ ] Stored [ ] Is Jib to be used: Yes [ ] No [ ]
Boom length _____ ft.	<b>Lift path cleared?</b>	Length of jib: _____ ft.
Boom angle at lift _____ deg.	[ ] yes [ ] no	Angle of jib: _____ deg.
Boom angle at set _____ deg.		Rated capacity of jib: _____ lbs.

RATED CAPACITY OF CRANE	LOAD LINE	WHIP LINE
360° _____ lbs.	Number of parts cable: _____	Number of parts cable: _____
Over side _____ lbs.	Size of cable: _____	Size of cable: _____
Over front _____ lbs.	Length _____	Length _____
Over rear _____ lbs.	lbs/ft _____	lbs/ft _____
	total weight: _____ 0 lbs	total weight: _____ 0 lbs

WEIGHT OF LIFT	SLING SELECTION
Weight of load: _____ lbs.	<b>Type of arrangement</b>
Weight of lifting beam <b>0</b> lbs.	
Weight of rigging _____ lbs.	Size _____ <b>0 ea</b> <b>0 cap</b> <b>0 lbs</b>
Weight of auxiliary rigging <b>0</b> lbs.	Size _____ <b>0 ea</b> <b>0 cap</b> <b>0 lbs</b>
<b>Additional weight:</b>	Size _____ <b>0 ea</b> <b>0 cap</b> <b>0 lbs</b>
Headache ball/ Load-block _____ lbs.	<b>Shackle selection</b>
Load line <b>0</b> lbs.	
Whip line <b>0</b> lbs.	
Jib deduction _____ lbs.	Size _____ <b>0 ea</b> <b>0 cap</b> <b>0 lbs</b>
<b>Allowance:</b>	Weight of rigging: _____ 0 lbs
Unaccounted material <b>0</b> lbs.	<b>Auxiliary rigging</b>
<b>Total weight:</b> <b>0</b> lbs.	
<b>% of crane capacity*:</b> _____	
	Come-a-long _____ <b>0 ea</b> <b>0 cap</b> <b>0 lbs</b>
	Chainfall _____ <b>0 ea</b> <b>0 cap</b> <b>0 lbs</b>
	Other _____ <b>0 ea</b> <b>0 cap</b> <b>0 lbs</b>

**LIFT**

**Critical Lift?** \_\_\_\_\_ **Serious Lift?** \_\_\_\_\_

If lift is critical, complete the following: crane layout and swing path schematic, rig arrangement and lift sequence

Source of load weight: \_\_\_\_\_

Weights verified by: **X** \_\_\_\_\_

**Sketch Required!** Unaccounted Material= 10%

Special instructions or restrictions for crane, rigging, lift, etc. \_\_\_\_\_

1 _____ Enbridge Rep	3 _____ Contractor Supervisor
2 _____ Operator reviewed	4 _____ Safety Representative

\* Multiple crane lifts require a separate lift plan for each crane. Any change in lift plan, rigging, etc. require that a new plan be developed.

INTERNAL INFORMATION  
White Copy - Technical Office  
Yellow Copy - Region Office  
Retain in Regional Office for asset +10 yrs

Page 1 of 1  
Page 1 of 1



## 11.2 LIFT DATA SHEET

	Lift Data Sheet	
--	-----------------	--

CRANE LAYOUT (SCHEMATIC)

A large grid area for drawing a crane layout schematic. The grid is approximately 30 columns wide and 40 rows high, providing a space for technical drawings.







---

**CHANGE LOG**

<b>Section</b>	<b>Version 1.4</b>	<b>Version 1.5</b>
Entire document		Clerical corrections including spelling, grammar, and document names.

<End of Document>





---

# Standard

---

## Hot Work and Ignition Sources

---

**Effective Date:** 2019-03-30

**Version #:** 1.6

**Version Date:** 2024-03-27

---



This page intentionally left blank



**Document Version Register**

Version Number	Version Date	Approved By	Section Number and Title	Details of Version
1.0	2019-03-30	Sean Evans	Whole Document (New Standard)	This is the new H&S standard that was developed as part of the LP   MP Safety Manual Transition Project
1.1	2019-10-31	Sean Evans	6.7 Cameras and Communication Equipment	Updated to reference personal gas monitors
1.2	2019-12-31	Sean Evans	6.3 Ignition Sources	As per Canadian Energy Regulator requirements, updated Canadian requirements to include provisions for: a maintenance, inspection and functional testing program of Positive Air Shut-Off (PASO) devices; assessment of the ignition hazard and associated level of onsite functional testing required for PASO devices; and completion of spot checks including functional testing where requested
1.2	2019-12-31	Sean Evans	4.0 Definitions & Acronyms	Added clarification around classifying Restricted Areas
1.3	2020-06-01	Sean Evans	2.0	Alignment with Contractor Safety Specifications
1.4	2021-12-01	Murray Evenson	9.0, 10	Updated section 9 to reflect the appropriate review process Added reference to section 10.0
1.5	2022-05-13	Murray Evenson	6.4.1, 6.8	Updated wording to align with OMM & Removed firearm section that belonged in the Safety Orientation & Visitor Access Standard (see change log)
1.6	2024-03-27	Troy Croft	All sections	Clerical corrections



This page intentionally left blank

---

## Table of Contents

1.0	Purpose .....	6
2.0	Scope .....	6
3.0	Prerequisites.....	6
4.0	Definitions & Acronyms .....	6
5.0	Roles & Responsibilities.....	7
6.0	Standard-Specific Requirements .....	8
6.1	Hot Work.....	8
6.2	Fire Watch .....	8
6.2.1	Prevent Fire .....	8
6.2.2	Ensure the safety of the workers in the area .....	9
6.2.3	Safely suppress and/or extinguish the fire.....	9
6.2.4	Additional Responsibilities .....	10
6.3	Ignition Sources.....	11
6.3.1	Diesel-Powered Equipment - Spark Arrestors.....	12
6.3.2	Diesel-Powered Equipment – Positive Air Shut-Off Devices - USA.....	12
6.3.3	Diesel-Powered Equipment – Positive Air Shut-Off Devices - CANADA.....	13
6.3.4	Pyrophoric Iron Sulfide .....	13
6.4	Bonding & Grounding .....	14
6.4.1	Bonding Cables .....	16
6.5	Induced Voltage.....	16
6.6	Cutting and Welding .....	17
6.7	Cameras and Communication Equipment.....	18
6.8	Smoking.....	18



---

7.0	Training Requirements .....	18
8.0	Related Documents .....	18
9.0	Standard Review .....	19
10.0	References .....	19
11.0	Appendix.....	20
11.1	Table 1 Installing Bonding Cables.....	20
	Change Log.....	21

## **1.0 PURPOSE**

The purpose of this standard is to provide the minimum requirements for Enbridge workforce and contractors when performing hot work or managing ignition sources at an Enbridge facility or worksite.

## **2.0 SCOPE**

This standard applies to LP Operations and Projects being completed for LP.

Contractors and subcontractors shall comply with Enbridge health and safety requirements set out in this standard, as articulated within applicable contractor safety specifications. If a contractor or subcontractor has a health and safety standard or policy materially different from Enbridge's, the contractor/subcontractor shall follow the most stringent requirement. Contractors and subcontractors are still obligated to meet the requirements of all applicable laws related to this standard.

In the event a contractor's or subcontractor's standard exceeds the requirements of this standard, Enbridge may, in its sole discretion, choose to adopt the contractor's or subcontractor's standard for any given contract or work order.

## **3.0 PREREQUISITES**

Hazard Assessment, Elimination and Control Standard

Safe Work Permit and Work Authorization Standard

## **4.0 DEFINITIONS & ACRONYMS**

*Atmospheric monitoring*—Continuous testing that details the atmospheric content of the worksite real time.

*Bonding*—connecting two objects together with metal, usually with a piece of copper wire. This bond prevents a difference in potential across the gap because it provides a conductive path through which the static charges can recombine. Therefore, no spark can occur.

*CP* – Cathodic Protection

*FLHA* – Field Level Hazard Assessment

*Grounding*—connecting an object to earth with metal, usually copper wire. The connection to earth is usually made to a ground rod or underground water piping.

*Hazardous area*—an area in which concentrations of flammable gases, flammable liquid-produced vapors, or combustible liquid-produced vapors can exist under normal operating conditions.

*Hot work*—any process that can be a source of ignition when flammable material is present or can be a fire hazard regardless of the presence of flammable material.

*PPE* – Personal Protective Equipment

*Qualified*—one who, by possession of a recognized degree, certificate, or professional standing, or who by knowledge, training and experience, has successfully demonstrated his ability to solve or resolve problems relating to the subject matter, the work, or the project.

*Restricted area*—An area in which volatile flammable gases, flammable liquid–produced vapors, or combustible liquid–produced vapors are handled, processed, or used, but in which the liquids, vapors, or gases will normally be confined within closed containers or closed systems from which they can escape only in case of accidental rupture or breakdown of such containers or systems or in case of abnormal operation of equipment.

*Safe work permit (SWP)*—an agreement between the permit issuer and receiver that is used to authorize work for a specific time and location and to ensure a safe area of work for the working group.

## **5.0 ROLES & RESPONSIBILITIES**

People Leaders shall:

- Ensure that employees, contractors and subcontractors under their control are aware of and comply with this standard;
- Ensure competency of fire watch personnel prior to work commencement;
- Confirm that all requirements of the safe work permit are being followed; and
- Ensure that all required fire protection equipment and resources are readily available.

Fire watch workers shall:

- Protect workers by monitoring for applicable hazards during a work activity;
- Prevent fire, ensure the safety of the workers in the area and, if possible, safely suppress and/or extinguish the fire without endangering themselves or others; and
- Enact emergency response procedures.

Workers shall:

- Understand and implement expectations of the safe work permit;
- Be knowledgeable of the hazardous and restricted areas within their work environment; and
- Follow ignition source precautions and requirements within this standard and field level hazard assessment.

Safety team shall:

- Provide advice, support and assistance to people leaders in the implementation of this standard.

Safety Shared Services shall:

**Uncontrolled Copy if Printed or Downloaded**



- Be responsible for the maintenance and continuous improvement of this standard.

## **6.0 STANDARD-SPECIFIC REQUIREMENTS**

### **6.1 HOT WORK**

Prior to commencing hot work ensure:

- Hot work has been selected under work types on the safe work permit (SWP);
- All movable fire hazards are removed and combustible materials (e.g. oil, rags, gasoline, paper) are removed from the hot work area and placed a safe distance away from the hot work;
- Verification of a non-explosive environment with an atmospheric monitoring device;
- Continuous monitoring of hot work area during hot work in hazardous and restricted areas and after the hot work has been complete;
- Guards are be used to confine heat, sparks and slag, if fire hazards cannot be removed; and
- Fire extinguishers are in place as required by the *Emergency Preparedness Standard*.

Monitor the environment during hot work to ensure an unknown or previously undetected flammable atmosphere does not develop.

### **6.2 FIRE WATCH**

Fire watch are designated personnel that have the responsibility to prevent and/or react to emergency situations in the event of a fire. The primary responsibilities of a fire watch are to, if possible:

1. Prevent fire;
2. Ensure the safety of the workers in the area; and
3. Safely suppress and/or extinguish the fire without endangering themselves or others, if possible.

**Note:** *If there are no line of sight concerns and it is permissible by the hazard assessment or safety project plan, one individual can perform the duties of a safety watch and fire watch. Please contact the safety team for further direction.*

The following details specifically what the responsibilities are for a designated fire watch at Enbridge Pipelines.

#### **6.2.1 PREVENT FIRE**

- Verify that all necessary hazard screenings, work authorizations, fire-prevention plans, and/or safe work permits are in place prior to work commencement;

- Review the requirements of the safe work permit and ensure that all workers have reviewed prior to hot work commencement;
- Verify that pre-use inspections have been completed on the following:
  - Fire suppression equipment (i.e., fire extinguisher);
  - Ventilation equipment;
  - Equipment to be used for hot work;
- Complete a field level hazard assessment (FLHA) prior to commencing work focusing on:
  - The work area;
  - Areas adjacent to the work area that may be affected by the hot work;
  - Elimination or control of hazards as required; and
  - Ensure that all affected workers participate in the FLHA.
- Confirm that isolation measures and controls determined by the safe work permit and/or field level hazard assessment have been implemented; and
- Verify that adjacent sewer manholes have been covered with fire blanket or as appropriate.

### **6.2.2 ENSURE THE SAFETY OF THE WORKERS IN THE AREA**

- Be familiar with the facility and the site specific emergency response plan;
- Identify the specific PPE requirements;
- Ensure any equipment identified as defective is reported to the appropriate people leader for replacement and repair; and
- Ensure appropriate warning signs and barricades are in place.

### **6.2.3 SAFELY SUPPRESS AND/OR EXTINGUISH THE FIRE**

- Recognize areas or conditions that may be affected by the hot work and be alert for changing conditions, developing hazards or signs of fire;
- Correct or stop any conditions that may lead to fire and report them to the appropriate personnel;
- Know how to use fire extinguisher equipment, where it is located and ensure it is operational prior to an event;
- Understand how to notify additional support (i.e. Operations, people leader) if required; and

- Inform appropriate personnel after extinguisher discharge so it can be recharged by qualified personnel and placed back into service.

#### **6.2.4 ADDITIONAL RESPONSIBILITIES**

A fire watch is required when engaged in certain hot work activities, including but not limited to:

- Welding, flame cutting, arc-air gouging or grinding in hazardous areas or restricted areas;
- Any hot work on or around open systems; and
- Any hot work where the potential for ignitable material may be present.

The role of the fire watch is to protect workers by monitoring for fire hazards during a work activity. A qualified worker shall be assigned the fire watch role and instructed based on the scope of work. The fire watch shall not be assigned or perform other duties.

If the fire watch leaves the work area the work activity shall stop, unless there is another qualified worker who can assume the fire watch duties.

The fire watch shall have the ability to clearly communicate to the workers under their care and access emergency response and site supervision as required.

One or more fire watch may be required when hot work is being conducted, based on the hazard assessment.

If hot work is being conducted in a hazardous or restricted area, then a fire watch is required and shall be maintained for at least one half hour after the work is completed.

A fire watch is also required when hot work is being executed in an unclassified area where combustible or flammable materials are present and could become a potential ignition hazard.

In addition, when hot work is conducted within 15 m (45 ft.) of an area with flammable or combustible contents, the fire watch shall check the area four hours after the work is completed, and document the results, unless:

- All flammable and combustible materials within 15 m. (45 ft.) are removed from the hot work area, or lined with non-combustible materials; and
- An approved engineering weld procedure is used when conducting hot work activities on pipelines and tanks containing product.

The person(s) planning and supervising the work shall assign a fire watch.

---

### **6.3 IGNITION SOURCES**

Ignition sources have the potential to cause fires and/or explosions in areas where flammable vapors/gases are potentially present in the air. Ignition sources are typically created during hot work activities. Ignition sources include:

- Sparks (e.g., from electrical tools and equipment; welding, cutting and grinding; static electricity, abrasive blasting);
- Use of lighters, matches, cigarettes;
- Open flames (e.g., portable torches and heating units);
- Surfaces with enough heat to vaporize a combustible material (e.g., catalytic converter of an automobile in dry grass); and
- Combustion engines or sources (e.g., vehicles/equipment, generators, compressors, mowers).

The following precautions shall be made to eliminate or minimize ignition sources:

- Vehicles and equipment left unattended in a restricted or hazardous area shall be shut off and not restarted until atmospheric monitoring confirms the absence of hazardous vapors;
- Do not stop vehicles or equipment in areas where there is combustible ground cover like dry grass, weeds or straw;
- Leave strike-anywhere matches and lighters with open mechanisms, including disposable lighters in designated areas (e.g., left inside a vehicle or locker);
- Do not position portable light plants and/or generator sets near combustible or flammable material; and
- Do not drill metals without sufficient lubrication.
- Further, when in hazardous and restricted areas:
  - Test for oxygen levels and flammable atmospheres prior to introducing ignition sources and continuously monitor these areas while ignition sources are present;
  - If a flammable atmosphere is present, use only explosion-proof electrical installations and explosion-proof electrical equipment;
  - Use only intrinsically safe electronic devices unless the air is initially tested and continuously monitored for flammable vapors and the equipment is listed on the SWP;

- Shutdown vehicles and equipment whenever possible or when left unattended (do not restart the vehicle or equipment until atmospheric monitoring confirms the absence of a flammable atmosphere);
- Use non-sparking tools that are kept clean and free from ferrous or other contaminants which may hamper non-sparking properties;
- Control all potential ignition sources; and
- Ground and bond as required;

When mechanically cutting pipe, ensure that the appropriate speed is used with sufficient lubrication to reduce potential for excessive heat production. Inspect and maintain equipment regularly (e.g., Friction in a defective or under-lubricated equipment bearing can overheat the bearing and cause a fire by vaporizing and igniting lubricating oil).

Workers shall review and observe the safe work permit including all atmospheric monitoring and sampling requirements prior to commencing work in a hazardous or restricted area.

### **6.3.1 DIESEL-POWERED EQUIPMENT – SPARK ARRESTORS**

When operating diesel-powered equipment (excluding turbocharged equipment), sparks and cinders can be emitted through the exhaust of the equipment as a result of incomplete combustion within the engine. These sparks and cinders have the potential to ignite vapors that may be present within hazardous and restricted areas. In order to control this hazard, the exhaust system of diesel-powered equipment (excluding turbocharged equipment) must be fitted with a functional spark arrestor.

To remain effective, spark arrestors shall be periodically blown clean with compressed air through the cleanout plug.

### **6.3.2 DIESEL-POWERED EQUIPMENT – POSITIVE AIR SHUT-OFF DEVICES – USA**

When operating diesel-powered equipment in hazardous and restricted areas, there is a potential for flammable vapors to enter the air intake of the engine of the equipment causing the equipment to continue running even when the ignition is turned off. The ongoing operation of this equipment can create the risk of ignition of the flammable atmosphere external to the equipment or may cause the engine to rev beyond its limits and fail catastrophically. In order to control this hazard, the air intake system of diesel-powered equipment operating in hazardous and restricted areas must be fitted with a functional positive air shut-off with or without a rev limiter. If using a positive air shut off without a rev limiter, a competent person must be stationed with the equipment to conduct continuous atmospheric monitoring and engage the manual shutoff switch.

For the purposes of satisfying the positive air shut off requirement above, hazardous and restricted areas are defined as written in API RP 500 for Class I Division I and Division 2, respectively.

---

### **6.3.3 DIESEL-POWERED EQUIPMENT – POSITIVE AIR SHUT-OFF DEVICES – CANADA**

When operating diesel-powered equipment in hazardous and restricted areas, there is a potential for flammable vapors to enter the air intake of the engine of the equipment causing the equipment to continue running even when the ignition is turned off. The ongoing operation of this equipment can create the risk of ignition of the flammable atmosphere external to the equipment or may cause the engine to rev beyond its limits and fail catastrophically. In order to control this hazard, the air intake system of diesel-powered equipment operating in hazardous and restricted areas must be fitted with a functional positive air shut-off with or without a rev limiter. If using a positive air shut off without a rev limiter, a competent person must be stationed with the equipment to conduct continuous atmospheric monitoring and engage the manual shutoff switch. The hazard of use of diesel driven equipment in hazardous and restricted areas and the use of positive air shut-off for control of the hazard should be documented on the hazard assessment for the work.

For the purposes of satisfying the positive air shut off requirement above, hazardous and restricted areas are defined as written in API RP 500 for Class I Division I and Division 2, respectively.

To ensure the functionality of positive air shut off devices, a maintenance and inspection program shall be established which includes provisions for periodic functional testing of the device. Maintenance and inspection records must be kept and include the results of periodic functional tests performed. These records will be provided to Enbridge upon request.

Further to the requirements for functional testing during routine maintenance and inspections, a functional test should be conducted prior to use of diesel-powered equipment in areas where vapors are known or suspected to be present (e.g., open systems, leak sites etc.). The need for pre-use functional testing should be identified as an additional control on the hazard assessment. Where using this equipment in such an area for more than one day, the need to complete additional functional tests (e.g., daily, weekly, etc.) should be further assessed based on the service and environmental conditions the equipment is exposed to.

Diesel-powered equipment fitted with positive air shut-off devices used in hazardous and restricted areas will be subject to spot checks on site. Spot checks may include the need to complete a functional test upon request by Enbridge. Spot checks may be completed as part of facility inspections, focused work practice inspections and/or safety observations. The spot checks and results of any associated functional tests completed will be recorded on the applicable documentation established for the assessment tool being utilized.

### **6.3.4 PYROPHORIC IRON SULFIDE**

Pyrophoric iron sulfide is a black deposit that can build up in locations such as storage tanks, seal pots, piping and metal sumps. It develops when sulfur comes in contact with iron. When the deposit dries, it can ignite spontaneously. Precautions include:

- Identify equipment where iron sulfide is suspected;

- Tanks and vessels shall be purged of hydrocarbon vapors before opening;
- When iron sulfide is suspected to be present, provisions shall be made to keep the inner surfaces of opened equipment wet; and
- Disposal of accumulated iron sulfide shall be handled quickly and carefully to avoid creating a hazard.

Pyrophoric iron sulfide deposits may develop in tanks where sour crude oil or refined products have been stored. These deposits can ignite spontaneously when they dry out. Use water spray to soak iron sulfide at least once every 24 hours, or more frequently if considered necessary by Operations management.

In cone roof tanks, iron sulfide deposits may develop above the normal level of oil in the tank, or in the sludge at the bottom of the tanks (through scale from the roof having flaked off). Iron sulfide in the sludge at the bottom of the tank is not a spontaneous ignition hazard in the tank, but it will ignite spontaneously if allowed to dry out in the sun.

On tanks with pantograph seals, iron sulfide deposits may develop in the vapor space between the sealing ring and the shell of the tank. Spray water into the vapor space at least once every 24 hours, or as often as necessary to keep this space damp. Other types of floating roof tanks do not require wetting down unless there is reason to suspect pyrophoric iron sulfide may be present.

## **6.4 BONDING & GROUNDING**

Electric charges can build up on an object or liquid when certain liquids (e.g., petroleum solvents, fuels) move in contact with other materials. This can occur when liquids are poured, pumped, agitated, stirred or flow through pipes. This buildup of electrical charge is called static electricity. Static electricity can potentially discharge which can lead to an explosion when sufficient amounts of flammable or combustible substances are located nearby.

To prevent the buildup of static electricity, it is important to bond or ground exposed metal. Bonding is done by making an electrical connection from one metal container to the other. Grounding is done by connecting the container to an already grounded object that will conduct electricity. This ensures that there will be no difference in electrical potential between the two containers and, therefore, no sparks will be formed.

Bonding and/or grounding shall be completed as required, including, but not limited to the following tasks:

- Cutting and separating a pipeline;
- Separating flanges;
- Loading or off-loading at sump tank locations;
- Dispensing flammable liquids from bulk drums into a secondary container;
- Removing an accessory attachment from a fixed facility (e.g., a mixer from a tank);

- Using abrasive blasting equipment to clean tanks;
- Hydrovacing;
- Spray painting;
- When using compressors, pumps and generators;

Bonding and/or grounding may be required for the following tasks:

- Drawing samples from the pipeline; and
- Draining oil from the pipeline into a pan.

Enbridge employee specific procedures for bonding, grounding and mitigating induced voltage can be found in the *OMM Book 3: Pipeline Facilities*.

In some cases, such as where piping forms an electrical bond, it may not be necessary to install bonding cables. Bonding cables shall meet Enbridge requirements set out in this standard, industry standards and applicable legislation.

Where cathodic protection (CP) rectifiers are thought to be an ignition source near hot work activities, consult with the regional CP representative before deactivation of a CP system.

Prior to use and during use, all portable equipment used in bonding and grounding work (e.g., welding units, generators, portable light plants, air compressors, etc.) shall be properly grounded, in accordance with manufacturers' specifications and worksite requirements.

Workers shall:

- Wear appropriate hand protection when there is potential exposure to induced high voltage, including when handling pipe, valves, casing or measuring;
- Avoid breaking, cutting or detaching bonding cables once they are in place, for as long as a fire hazard exists;
- Ground or electrically bond containers to each other when transferring liquids;
- Only fill portable fuel containers when they are on the ground (never do so in truck beds, on tailgates or in the trunks of vehicles);
- Immediately contact people leader if there are any concerns about induced high voltage and work equipment;
- Ensure each bonding or grounding point is clean and free of paint, with a positive connection;
- Never use chains for bonding or grounding purposes; and
- Perform visual inspection of the cables and connection as required to ensure positive connection is maintained.



Please reference the *Ground Disturbance Standard* prior to executing bonding and/or grounding activities.

#### **6.4.1 BONDING CABLES**

When drawing oil or product samples from the line, or when loading or off-loading at sump tank locations use an uncovered braided copper wire with an alligator clip brazed/clamped to each end (or use other suitable bonding cable).

- Each pipeline crew must have at least 2 prefabricated bonding cables made of appropriate gauge stranded copper wire with a spade connector brazed on each end.
- Each pipeline crew must have at least 2 grounding clamps for attaching the bonding cable to the pipe.

#### **6.5 INDUCED VOLTAGE**

Where the pipeline follows a power line ROW, a hazard may exist if the pipeline lies within the electrical field generated by overhead transmission lines. The pipe can carry a hazardous alternating current (AC) voltage, known as induced voltage, which occurs as a result of stray electromagnetic field from the power lines. This hazard can also apply to pipe set up near high voltage sources on cribbing for welding.

Additional factors:

- The voltage level depends on the current in the transmission lines, the geometric configuration of the pipeline with respect to the transmission lines, and the length of pipeline paralleling the transmission line;
- Induced voltage caused by proximity to overhead transmission lines may continue to affect pipelines, even when the pipeline no longer parallels the transmission cables. Induced voltage can be a hazard for up to 16 km (10 mi) beyond the point of departure;
- Once a below grade facility is exposed, it shall be checked for induced voltage prior to commencing work on the facility. The facility shall be continually checked for induced voltage as required or monitored based on the hazard assessment;
- The industry-accepted safe limit for induced voltage limit on pipelines, appurtenances and other below grade facilities is 15V. Therefore, bonding and grounding is required to bleed off any charge in excess of 15V;
- If further aid is required to reduce the induced voltage to below 15V, contact Operations Engineering to determine the need to install a grounding grid for bonding and grounding below grade facilities, vehicles and equipment. If a grounding grid is installed, before starting work, ensure induced voltages on the bonded pipe, vehicles and equipment have been reduced to an acceptable level;
- Potential induction sites/areas (T-lines) shall be tested by a qualified worker;

- Only qualified workers are to mitigate induced voltage hazards and shall do so according to grounding pipe for induced voltage, *OMM Book 3: Pipeline Facilities* (subject 06-03-01); and
- When the potential for induced voltage exists, a hazard assessment shall be completed and reviewed with the involvement of the workers doing the work.

Contractors shall develop a safe work plan for controlling induced voltage. This plan shall include, but is not limited to, the following:

- Specialized PPE;
- Measuring/testing;
- Work stoppage for adverse weather conditions; and
- Grounding requirements for planned work.

For more information on installing bonding cables in specific scenarios see Appendix Table 1.

## **6.6 CUTTING AND WELDING**

When welding and cutting, precautions shall be taken against exposure to:

- Excessive ultraviolet radiation;
- Burns;
- Fire and/or explosion;
- Asphyxiation;
- Exposure to toxic gases; and
- Fumes or dusts.

If welding or cutting cannot be conducted safely, then it shall not be performed until safe to do so following a hazard assessment. Remove flammable materials and products from the immediate vicinity when cutting or welding.

If necessary, use partitions to enclose welding and cutting activities. Before work begins, the welder, or welder's helper, shall ensure that no other worker is at risk of exposure to the arc flash, cutting slag or the spark path. Ensure non-essential workers are removed from the hot work area and are restricted from gaining unauthorized access.

Turn welding machines off at the end of each workday or when left unattended.

The ground return line from the work being welded shall:

- Be a single cable rated for the load of the welding machine;
- Be in good condition; and

- Only be clamped to the material being welded.

## **6.7 CAMERAS AND COMMUNICATION EQUIPMENT**

Cameras, audio-visual and communications equipment are only allowed on Enbridge worksites with the permission of regional operations and project management. No pictures shall be taken without the approval of regional or project management.

In hazardous and restricted areas, a safe work permit may be required, see the Safe Work Permit and Work Authorization Standard for additional information.

## **6.8 SMOKING**

Smoking, including electronic cigarettes, is only allowed outdoors in marked, designated areas; a proper waste container shall be provided, along with a 20 lb. ABC fire extinguisher.

Unless prohibited by applicable legislation (e.g., vehicles, busses, labs, offices etc.), smoking is permitted on the right of way (ROW) providing that the ROW is stripped of vegetation and the work activity is outdoors on exposed mineral soil. The ROW shall be kept free of discarded cigarette butts by providing an adequate number of waste containers and 20 lb. ABC fire extinguishers shall be readily available. Smoking outside of marked smoking areas on the ROW is prohibited.

## **7.0 TRAINING REQUIREMENTS**

Personnel working in the field must be knowledgeable in this Standard and may be assigned applicable training as driven by the Safety Training Matrix.

Reference the Health & Safety training syllabi and matrices for further information and training re-certification requirements.

## **8.0 RELATED DOCUMENTS**

Grounding Cables

Grounding Pipe for Induced Voltage

Grounding Systems

Installing Bonding Cables

Lateral Dispersion & Release Models for Various Crudes, Wind Speeds and PSI

Overview of Maintenance and Repair Welding

Performing Grinding Repairs

Safely Grounding High Voltage Equipment

Welding Equipment

Welding Preparation

---

## **9.0 STANDARD REVIEW**

## **10.0 REFERENCES**

Occupational Safety and Health Administration (OSHA)

- Flammable and combustible liquids, 1910.106
- Fire Prevention Plans, 1910.39
- Portable Fire Extinguishers, 1910.157

CSA Z662 – Oil and Gas Pipeline Systems

Canada Labour Code, Part II; Canadian Occupational Safety & Health (COSH) regulations

- Hazardous Substances, 10.1
- Safe Occupancy of a Work Place, 17.1

## 11.0 APPENDIX

### 11.1 TABLE 1 INSTALLING BONDING CABLES

Task	Bond From	Bond To	Notes
Abrasive Blasting Equipment for Tank Cleaning	1. Blasting hose nozzle	1. Tank shell or tank roof	
Cutting, Installing and Separating of a Pipeline	1. Grounding clamp on one side of separation 2. Second cable from grounding clamp on one side of separation	1. Grounding clamp on other side of separation 2. Grounding clamp on pipe section to be removed or installed	Ensure clamps make contact with clean, bare metal. First cable shall be long enough to span the work area. Second cable shall be long enough to clear the hazardous area when removing or installing pipe section.
Drawing Samples from Pipeline	1. Attach alligator clip on one end of bonding cable (unbraided copper) to sample point on pipeline (i.e., pipe, valve)	1. Other end of Bonding cable to alligator clip on metal sample container	
Draining Oil From Pipeline to Pan	1. Pipeline	1. Metal drain tray	For plastic drain trays, second end of bonding cable shall remain in contact with liquid being drained into tray at all times.
Loading or Off-loading at Sump Tank Locations	1. Object being loaded/off-loaded	1. Sump tank or piping connection at loading/off-loading facility	For fiberglass sump tanks, attach second end to specified bonding point.
Dispensing from Bulk Drums to Secondary Container	1. Bulk drum	2. Secondary container	One container shall be grounded, and the other container bonded to the grounded container.
Removing accessory attachments from fixed facilities	1. Clean, bare metal on accessory attachment	1. Fixed facility	Bonding cable shall be long enough to clear the hazardous area when removing attachments or span of work area when separating flanges.
	1. Flange	1. Flange	
Hydrovacating Near Underground Electrical Wires	1. Wand/Gun 2. Dig Tube 3. Mat # 1 4. Mat #1	1. Grounding mat # 1 2. Grounding mat # 2 3. Mat # 2 4. Hydrovac truck	For distances greater than (>) 2m (6 ft.) from the hydrovac truck, it may not be necessary to bond the mat to the truck (Step 4).

Note: Some tasks require more than one bonding cable. The numbers listed in this table represent steps to be taken for proper bonding (i.e., bond 1 to 1, and 2 to 2, etc.).



---

## CHANGE LOG

	Version 1.5	Version 1.6
Entire document		Clerical corrections including spelling, grammar, and document names.

<End of Document>



---

# Standard

---

## Hydrostatic and Pneumatic Testing

---

**Effective Date:** 2019-03-30  
**Version #:** 1.3  
**Version Date:** 2024-03-27

---



This page intentionally left blank





Document Version Register

Version Number	Version Date	Approved By	Section Number and Title	Details of Version
1.0	2019-03-30	Sean Evans	Whole Document (New Standard)	This is the new H&S standard that was developed as part of the LP   MP Safety Manual Transition Project
1.1	2020-06-01	Sean Evans	2.0, 5.0	Alignment with Contractor Safety Specifications
1.2	2021-12-01	Murray Evenson	9.0, 10.0	Updated section 9 to reflect the appropriate review process Added reference to section 10.0
1.3	2024-03-27	Troy Croft	All sections	Clerical corrections

Uncontrolled Copy if Printed or Downloaded



This page intentionally left blank

---

## Table of Contents

1.0 Purpose .....	2
2.0 Scope .....	2
3.0 Prerequisites.....	2
4.0 Definitions & Acronyms .....	2
5.0 Roles & Responsibilities.....	2
6.0 Standard – Specific Requirements.....	3
6.1 Hydrostatic Testing.....	4
6.2 15m (50ft.) Zone (Exclusion Zone).....	4
6.3 30m (100ft.) Zone .....	5
6.4 Pneumatic Testing.....	5
7.0 Training Requirements .....	5
8.0 Related Documents .....	5
9.0 Standard Review .....	6
10.0 References .....	6

---

## **1.0 PURPOSE**

The purpose of this standard is to provide the minimum safety requirements for all hydrostatic and pneumatic testing completed within LP Operations and projects being completed for LP to ensure that it is executed safely and reliably.

## **2.0 SCOPE**

This standard applies to LP Operations and Projects being completed for LP.

Contractors and subcontractors shall comply with Enbridge health and safety requirements set out in this standard, as articulated within applicable contractor safety specifications. If a contractor or subcontractor has a health and safety standard or policy materially different from Enbridge's, the contractor/subcontractor shall follow the most stringent requirement. Contractors and subcontractors are still obligated to meet the requirements of all applicable laws related to this standard.

In the event a contractor's or subcontractor's standard exceeds the requirements of this standard, Enbridge may, in its sole discretion, choose to adopt the contractor's or subcontractor's standard for any given contract or work order.

## **3.0 PREREQUISITES**

Emergency Preparedness – Personal Safety Standard

Flagging and Warning Signs Standard

Hazard Assessment, Elimination and Control Standard

Safe Work Permit and Work Authorization Standard

## **4.0 DEFINITIONS & ACRONYMS**

ROW—Right of Way

## **5.0 ROLES & RESPONSIBILITIES**

People leaders/Enbridge site inspectors shall:

- Ensure that employees, contractors and subcontractors under their control are aware of and comply with this standard; and
- Confirm that all requirements of the safe work permit are being followed.

Contractor site supervisors shall, as articulated within the applicable contractor safety specifications:

- Ensure that employees, contractors and subcontractors under their control are aware of and comply with this standard; and

- Confirm that all requirements of the safe work permit are being followed.

Employees shall:

- Understand and implement expectations of this standard, safe work permit and field level hazard assessment (FLHA).

Safety Team shall:

- Provide timely advice, support and assistance to people leaders in the implementation of this standard.

Safety Shared Services shall:

- Be responsible for the maintenance and continuous improvement of this standard.

## **6.0 STANDARD – SPECIFIC REQUIREMENTS**

Where necessary, permits shall be obtained by Enbridge or the contractor as specified in the contract between Enbridge and the contractor. Copies of all permits (e.g., local, state, federal or provincial) shall be in the possession of the contractor site supervisor as well as the Enbridge site inspector.

For worksite(s) where a section of piping is being tested, an Enbridge representative shall be on-site.

At the testing location there shall be:

- A safe means of access and egress for trenches and properly installed scaffolding, as needed;
- Adequate lighting when night work is necessary and a fire extinguisher at both ends of a test section; and
- Adequate heating and lighting facilities for test workers located a minimum of 15 m (50 ft.) away from any testing facilities.

Other requirements include:

- Ensuring that only the workers directly involved in the testing are in the immediate vicinity of test heads, pressure pumps or exposed piping during testing;
- Ensuring temporary piping or hoses used during pressuring and depressurizing activities are anchored or secured by such method(s) as whip check connections, steel braid line wrap, or staking to the ground, to prevent them from moving or violently separating;
- Ensuring the use of appropriate hoses, piping, fittings, valves, etc., and that such equipment has an adequate pressure rating for the service; inspect the equipment before use, to ensure it is in good condition;

- Ensuring persons not directly involved in the testing shall be kept back a minimum of 30 m (100 ft.) from the pipeline, by the use of signs, fencing, and verbal warnings;
- Verifying pressure on both sides of check valves when hydro testing and depressurizing; and
- Providing a safe means to release pressure from both ends of the piping section; pressure shall be released prior to loosening or removal of fittings.

## **6.1 HYDROSTATIC TESTING**

Two zones shall be established around any hydro test: a 15 m (50 ft.) exclusion zone and a 30 m (100 ft.) zone. These requirements shall be followed during all hydro tests. Unique circumstances may require additional measures to ensure the safety of workers and the public.

For testing being conducted only on the ROW, expand the 15 m (50 ft.) zone requirements to the 30 m (100 ft.) zone dimensions.

If leaks are observed (through gauge drop or visual inspection) then the pressure must be reduced to zero pounds per square inch (PSI) prior to entering the exclusion zone. No adjustments of any kind are to be performed on pressurized piping.

Fuel containers, propane tanks, and other fuel storage shall not be permitted within the 15 m (50 ft.) zone. Testing trailers shall be parked with the entrance facing away from the test area. The testing trailer door(s) shall remain closed during testing operations. If it is necessary to test indoors, the 15 m (50 ft.) exclusion zone shall encompass the entire room in which the test is completed.

## **6.2 15 M (50 FT.) ZONE (EXCLUSION ZONE)**

Facilities for test personnel and equipment shall be outside the 30 m (100 ft.) exclusionary zone.

On Company property, signs shall be placed by the contractor on the day of the test. These signs, which are to remain in place until after the piping system has been depressurized, shall read as follows:

“DANGER – RESTRICTED ENTRY – HIGH PRESSURE TESTING AREA  
AUTHORIZED PERSONNEL ONLY”

All unnecessary equipment and workers shall stay out of this zone when the pipe is pressurized above normal operating pressures.

Ensure the 15 m (50 ft.) zone applies over the entire length of the pipeline, spools or fittings being tested. Note: Within populated areas, traffic control is required and shall be identified in the field level hazard assessment and as part of the safe work permit.

Workers shall stay in their vehicles if they are within this zone monitoring the pipeline during the hydro test, with the exception of checking for leaks or opening or closing valves.

Hydro test signs shall be placed on public access points and located at a point 15 m (50 ft.) from the pipeline.

### **6.3 30 M (100 FT.) ZONE**

This zone will not be marked; the public and other workers shall stay at least 30 m (100 ft.) away from the pipe.

This zone applies over the entire length of the pipeline section being tested.

The public shall be kept out, except when crossing the pipeline in vehicles.

Landowners along the right-of-way shall be notified in advance of the hydro-test and those living within the 30 m (100 ft.) zone shall be offered relocation assistance.

In the event piping and equipment is present in the test area or within 30 m (100 ft.), of the pressurized components, the area shall be flagged and remain off limits to all workers during the test.

When testing trailers or vehicles are parked, implement extra precautions as necessary (e.g., stage behind large equipment).

When testing in buildings, all points of entry are to be manned or blocked. All personnel working in the building must be appropriately notified.

### **6.4 PNEUMATIC TESTING**

Must adhere to Engineering's specifications for pneumatic testing.

Distinct warning signs shall be posted during air pressure testing, such as "DANGER, AIR PRESSURE TESTING IN PROGRESS."

### **7.0 TRAINING REQUIREMENTS**

Personnel working in the field must be knowledgeable in this Standard and may be assigned applicable training as driven by the Safety Training Matrix. Reference the Health & Safety training syllabi and matrices for further information and training re-certification requirements.

### **8.0 RELATED DOCUMENTS**

Facility Construction Specifications

Hydrostatic Test Notifications/Permits/Approvals

Pipeline Construction Specifications

Strength | Leak Testing

Test Planning & Site Preparation

## 9.0 STANDARD REVIEW

## 10.0 REFERENCES

Canada Labour Code, Part II:

- Canadian Occupational Health & Safety Regulations, Hazard Prevention Program; Part XIX

CSA Z662 - Oil and Gas Pipeline Systems

- 8.2 Safety during pressure tests

Occupational Safety and Health Administration (OSHA) Act

- Section 5, Duties

### Change Log

Section	Version 1.2	Version 1.3
Entire document		Clerical corrections including spelling, grammar, and document names.

<End of Document>





---

# Standard

---

## Industrial Hygiene

---

**Effective Date:** 2019-03-30  
**Version #:** 1.4  
**Version Date:** 2024-03-28

---



This page intentionally left blank



Document Version Register

Version Number	Version Date	Approved By	Section Number and Title	Details of Version
1.0	2019-03-30	Sean Evans	Whole Document (New Standard)	This is the new H&S standard that was developed as part of the LP   MP Safety Manual Transition Project
1.1	2019-10-31	Sean Evans	6.4, 6.4.1, 6.5.5, 6.5.7	Refer to Change Log
1.2	2020-06-01	Sean Evans	2.0	Alignment with Contractor Safety Specifications
1.3	2021-12-01	Murray Evenson	1.0, 2.0, 6.4.1, 9.0, 10 & various sections throughout	Refer to Change Log
1.4	2024-03-28	Troy Croft	All sections 6.7, 6.7.2	Clerical corrections Alignment with Hearing Loss Prevention & Noise Control Plan



This page intentionally left blank

---

## Table of Contents

1.0	Purpose .....	3
2.0	Scope .....	3
3.0	Prerequisites.....	3
4.0	Definitions & Acronyms .....	3
5.0	Roles & Responsibilities.....	5
6.0	Standard-Specific Requirements .....	5
6.1	Characteristics of Products Transported by Pipeline .....	5
6.1.1	Natural Gas Liquids (NGLs) .....	6
6.1.2	Diluent.....	6
6.2	Entering Buildings Containing Natural Gas Products or Equipment .....	6
6.3	Radiation & Radiography.....	7
6.3.1	Site Preparation / Work Control.....	7
6.3.2	Sealed Radioactive Sources .....	8
6.4	Asbestos Management Program.....	8
6.4.1	Determining the Presence of ACMs or PACMs.....	9
6.5	Respiratory Hazards.....	10
6.5.1	Prevention of H <sub>2</sub> S Exposures .....	10
6.5.2	Prevention of Benzene Exposures .....	11
6.5.3	Prevention of Oxygen Deficiency .....	12
6.5.4	Nuisance Dusts.....	13
6.5.5	Cadmium and Lead .....	13
6.5.6	Welding Fumes.....	14
6.5.7	Crystalline Silica .....	14
6.6	Nitrogen (Pipeline Purging) .....	14
6.6.1	Site Preparation / Work Controls .....	15
6.7	Hearing Conservation.....	15
6.7.1	Audiometric Testing .....	16
6.7.2	Additional Hearing Protection Measures .....	17

**Uncontrolled Copy if Printed or Downloaded**



---

7.0	Training Requirements .....	18
8.0	Related Documents .....	18
9.0	Standard Review .....	18
10.0	References .....	18
	Change Log .....	20

## 1.0 PURPOSE

Enbridge's industrial hygiene program protects workers from work-related illnesses and injuries. The program will anticipate, recognize, evaluate, and control the industrial hygiene hazards that workers may be exposed to in the workplace.

Worker exposure shall be assessed for all physical, chemical, and biological agents. Exposures will be measured against Exposure Limits. An Exposure Limit is a workplace standard below which is believed that nearly all normal and healthy Workers may be repeatedly exposed, day after day, for working lifetime without adverse health effects.

Exposure mitigation and control protocols will be utilized anytime a measured exposure is above an Action Level, where applicable. An Action Level is a threshold value, equal to or below the Exposure Limit, which initiates an exposure mitigating response action.

Worker exposure shall be determined, qualitatively or quantitatively, prior to the start of new projects or job tasks. Periodic exposure surveillance may also be required for routine or continuous work practices.

## 2.0 SCOPE

This standard applies to LP Operations and Projects being completed for LP.

Contractors and subcontractors shall comply with Enbridge health and safety requirements set out in this standard, as articulated within applicable contractor safety specifications. If a contractor or subcontractor has a health and safety standard or policy materially different from Enbridge's the contractor/subcontractor shall follow the most stringent requirement. Contractors and subcontractors are still obligated to meet the requirements of all applicable laws related to this standard.

## 3.0 PREREQUISITES

Asbestos Management Plan

Atmospheric Monitoring Standard

Crystalline Silica Management Plan

Hazard Assessment, Elimination and Control Standard

Hazardous Communication & WHMIS Standard

Immediately Dangerous to Life and Health Atmospheres Procedure

Inspection Standard

Safe Work Permit and Work Authorization Standard

## 4.0 DEFINITIONS & ACRONYMS

ACM – Asbestos-Containing Materials

*Exposure Limit* - Workplace standard below which is believed that nearly all normal and healthy workers may be repeatedly exposed, day after day, for working lifetime without adverse health effects.

*Fatigue* - Weariness or exhaustion due to extended periods of physical and/or mental exertion or illness.

*H<sub>2</sub>S* – Hydrogen sulfide

*Immediately Dangerous to Life or Health (IDLH) Concentrations* – An atmospheric concentration of any toxic, corrosive or asphyxiant substance that poses an immediate threat to life or would cause irreversible or delayed adverse health effects or would interfere with an individual's ability to escape from a dangerous/hazardous atmosphere.

*LEL* – Lower Explosive Limit

*NDT* – Non-Destructive Testing

*NGL* – Natural Gas Liquids

*PACM* – Presumed Asbestos-Containing Materials

*RPE* – Respiratory Protective Equipment

*RSO* – Radiation Safety Officer

*Self-Contained Breathing Apparatus (SCBA)* – A respirator that has a portable supply of breathing air and is independent of the ambient atmosphere. The breathing air source is designed to be carried by the user.

*Short Term Exposure Limit (STEL)* – A 15-minute Time Weighted Average (TWA) exposure limit that should not be exceeded at any time during a workday even if the overall 8-hour TWA is within limits, and it should not occur more than 4 times per day. There should be at least 1 hour between successive exposures.

*Threshold Limit Value (TLV)* – Occupational exposure limit set by the American Conference of Governmental Industrial Hygienists (ACGIH) under which it is believed that nearly all workers may be repeatedly exposed, day after day, over a working lifetime, without adverse health effects.

*Time Weighted Average (TWA) Exposure Limit* – the average exposure a contaminant for an individual over a given working period determined by sampling at given times during the period. Unless otherwise mentioned, TWA is the concentration of contaminants measured over an 8-hour period.

*Vapor* - Gaseous form of substances that are normally in liquid or solid state; it can be changed to solid or liquid by increasing pressure, decreasing temperature, or both. Evaporation may create vapors.



## 5.0 ROLES & RESPONSIBILITIES

People Leaders shall:

- Verify through spot checks that workers are using the tools made available to them to ensure known or potential hazards are identified and controlled to prevent worker exposure.

Workers shall:

- Participate in the identification of potential hazards and monitoring of implemented controls to prevent exposure.

Safety Team shall:

- Provide timely advice, support and assistance to people leaders and inspection leads in the implementation of this standard.

Safety Shared Services shall:

- Be responsible for the maintenance and continuous improvement of this standard.

## 6.0 STANDARD-SPECIFIC REQUIREMENTS

### 6.1 CHARACTERISTICS OF PRODUCTS TRANSPORTED BY PIPELINE

Enbridge's pipeline system transports various non-refined, synthetic, semi-refined or refined hydrocarbon liquids and natural gas liquids.

All products transported by pipeline shall be considered toxic and flammable volatile hydrocarbon liquids. All of these liquids are under pressure when the system is operating.

Vapors and gases released by these liquids:

- may create breathing hazards, as well as fire and explosion hazards
- are heavier than air, and will accumulate in buildings, confined spaces, and low areas such as pits, excavations, bermed areas and natural depressions in the ground

The primary breathing hazards associated with the pipeline products being pumped include petroleum vapors, benzene vapors and H<sub>2</sub>S gas.

H<sub>2</sub>S at levels of 100 ppm (IDLH) or more may be present in crude oils and condensates classified as sweet or sour. For additional information on IDLH environments, refer to the Immediately Dangerous to Life and Health Atmospheres Procedure on the Governance Documents Library (GDL).

Workers are at greatest risk of being exposed to these types of vapors and gases when working around free or released product and open systems. The risk of exposure also exists when working in hazardous areas and restricted areas.

- Respiratory, fire and explosion hazards have the potential to exist around spills and open systems until the area or system is free of liquid and determined to be isolated and gas-free
- Gas detection is required to verify a safe atmosphere. Appropriate RPE shall be worn, as specified in job-specific procedures, and as required based on the results of atmospheric monitoring.

### 6.1.1 NATURAL GAS LIQUIDS (NGLS)

NGLs contain propane, butane and condensates such as heptane, hexane and pentane.

NGLs are considered to be the most hazardous of the products transported by pipeline.

When released into the atmosphere, NGLs may look like a steam cloud close to the source. NGLs are extremely cold, with a boiling point of  $-42^{\circ}\text{C}$  ( $-44^{\circ}\text{F}$ ).

NGL vapour may smell something like gasoline and may have a narcotic and intoxicating effect which could lead to unconsciousness.

Since NGLs are extremely flammable, all ignition sources shall be eliminated.

### 6.1.2 DILUENT

Like most petroleum, diluent is flammable and contains volatile substances in varying percentages. The lighter hydrocarbons included in diluent are typically naphtha, benzene and pentane.

As with other pipeline liquids, keep ignition sources away from diluents.

In the event of a release, use RPE as required.

## 6.2 ENTERING BUILDINGS CONTAINING NATURAL GAS PRODUCTS OR EQUIPMENT

Buildings containing natural gas are provided with fixed gas detection equipment that is equipped with an alarm. The alarm will be triggered at the following concentrations of natural gas:

- 20% of LEL – low level alarm (audible and visible)
- 40% of LEL – high level alarm (audible and visible); results in an emergency shutdown

If the alarm for a fixed gas detection system has been triggered, conduct initial atmospheric monitoring from outside the compressor building, if possible.

Before entering any buildings where natural gas is present, operate valves as necessary to shut down or bypass the source of gas and/or ventilate the building (e.g., open doors and windows).

The minimum entry criteria for entering buildings containing natural gas products or equipment are:

- at  $<10\%$  LEL, entry is allowed
- at  $10\text{-}20\%$  LEL, entry is allowed if:
  - only cold work is planned

- Safety Watch is present at all times
- at >20% LEL, entry is allowed for inspecting or opening and closing valves to reduce gas levels provided:
  - a Safety Watch is present at all times monitoring atmospheric levels
  - a safety harness and lifeline are used and an employee trained in their use is present and in control of the lifeline
  - self-contained breathing apparatus (SCBA) or a supplied-air respirator (SAR) with egress bottle is used

Conduct continuous atmospheric monitoring while approaching the work area to verify acceptable conditions. If concentrations are higher than prepared for, exit the area and reassess the situation.

### 6.3 RADIATION & RADIOGRAPHY

When required, a contractor who is licensed and properly qualified to perform radiography and NDT will be contracted to provide these services.

In all instances where X-ray or gamma ray equipment is being used, the contractor shall ensure the use, storage, handling, transportation, and disposal of radioactive substances is in compliance with all applicable legislation. All radiographic work completed by the contractor shall be performed under the direction of a federally licensed worker (radiographic technician) responsible for radiation safety.

For additional information, refer to the applicable Radiation Safety Standard on the GDL.

#### 6.3.1 SITE PREPARATION / WORK CONTROL

Before radiography work begins, ensure:

- Distinctive warning signs are posted – DANGER! RADIOACTIVE MATERIAL, and
- Barricades or rope are placed to prevent access to the designated work area (Radiation Area).

Workers (and their vehicles and equipment) not involved in the radiography work shall remain outside of the designated Radiation Area until the radiographic technician provides notification that testing is complete and it is safe to enter.

Additional radiography requirements include:

- Where required by applicable legislation, radiographic inspection vehicles shall have 360 degree rotating amber lights on the roof and be clearly visible; the rotating lights shall be operating when X-ray/Gamma ray equipment is in use;

- Equipment or storage containers holding radioactive material shall be labeled “DANGER! RADIOACTIVE MATERIAL” and locked when not in use; a nameplate shall also be affixed to the equipment/container showing the owner’s name, the maximum quantity, the type of radioactive material and a symbol (trefoil) indicating ionizing radiation;
- In an emergency or facility evacuation, the radiographic technician shall ensure that the radioactive source is in a secure position, isolated and safe before leaving the work area.

Contractors performing this work are responsible for acquiring, transferring or disposing of any and all radioactive material associated with this testing. When legally required to have a Radiation Safety Officer (RSO) present, the contractor shall provide a qualified individual.

### **6.3.2 SEALED RADIOACTIVE SOURCES**

Acquisition of radioactive materials for installation on Enbridge operating assets shall be made in accordance with the existing specific licenses and coordinated through the Enbridge RSO. Any new source material and source holders shall be added to the license through an amendment prior to purchase. All shipments of such material shall be completed in accordance with the current license including the issuance of transfer documents for shipping and the receipt of the material.

Radiation sources for installation or removal shall only be handled by an individual who is licensed and qualified to handle the specific source and holder in question.

At the time of installation, a radiation survey shall be performed by the installer to ensure that the source and holder are operating properly and radiation levels around the source are within expected background levels.

### **6.4 ASBESTOS MANAGEMENT PROGRAM**

Determine if work in an area will disturb, or has the potential to disturb, confirmed or presumed Asbestos-Containing Materials (ACM). Consult the Asbestos Management Plan found in the GDL for information applicable to your jurisdiction prior to engaging in any work that involves the removal or disturbance of ACM.

Procedures for removing asbestos are largely similar, but with some slight differences in each jurisdiction (e.g., country, province, state, or local municipality). Contact Corporate Health & Safety personnel 30 days in advance of asbestos remediation projects, and obtain clarification or verification of applicable procedures or updates/changes to the procedures.

Completion of Asbestos Awareness training is required for all workers who could potentially be exposed to Asbestos Containing Material (ACM). In addition to this general awareness training, workers can access resources and written materials from Health and Safety. Additional training may be required for workers who engage in specific work activities involving ACM.

Contractors shall evaluate the awareness training requirement based on work type. All products with asbestos fibers and all containers of asbestos shall be labeled as follows:

- Danger: contains asbestos fibers. Avoid creating dust. Cancer and lung disease hazard.

Asbestos fibers inhaled into the lungs can lead to lung cancer, asbestosis or mesothelioma.

If a worker's exposure to asbestos is verified as beyond the 8-hour TWA limit of 0.1 f/cc and/or the 30-min excursion limit of 1 f/cc and/or the 30-min excursion limit of 1 f/cc, then medical surveillance of that worker shall be required.

Where atmospheric monitoring indicates that the TWA and/or excursion limit is exceeded, a written program to reduce worker exposure shall be implemented regionally.

For additional information, refer to the Asbestos Management Plan on the GDL.

#### **6.4.1 DETERMINING THE PRESENCE OF ACMs OR PACMS**

The following are common examples of ACMs that are known to contain asbestos or presumed (PACM) to contain asbestos:

- Insulation on abandoned waste heat boilers and piping,
- Plain and perforated asbestos board panels on interior walls and ceilings, e.g., in some station buildings,
- Insulation on standby generator exhaust piping,
- Some floor tiles,
- Gasket material on pumping units,
- Flanges on piping,
- Some pipe coating, e.g., coal tar wrap,
- Underground concrete electrical duct banks at terminal sites,
- Vermiculite insulation,
- Electrical switchgear.

To determine the location of ACMs, review the Asbestos Inventory. Contact the Corporate Health & the local operations supervisor or an Enbridge Representative for the Asbestos Inventory.

Bulk samples for laboratory asbestos analysis shall be taken by a Qualified Worker.

Samples shall be collected in accordance with the procedures outlined in the appropriate Asbestos Procedure found in the GDL.

## 6.5 RESPIRATORY HAZARDS

At Enbridge locations where there is the potential for workers to be exposed to the respiratory hazards detailed in this section, the following shall occur:

- implement engineering controls and work practices to reduce employee exposure to below the Exposure Limit
- develop a hazard assessment and ensure a control plan is completed
- have provisions for site-specific contingency/emergency plan
- ensure personal exposure monitoring is performed where required
- make detection and monitoring equipment available for personal and area monitoring (refer to Atmospheric Monitoring Standard)
- before work begins, inform employees of any potential exposures at the site or facility
- communicate the results of exposure monitoring to all affected employees
- ensure initial and periodic atmospheric monitoring is completed where required (refer to Atmospheric Monitoring Standard)
- beyond the basic PPE, also make available any additional PPE or RPE that may be required for a given hazard (refer to Personal Protective Equipment and Respiratory Protection Standards)

For additional information, see the Atmospheric Monitoring, Personal Protective Equipment and Respiratory Protection Standards.

### 6.5.1 PREVENTION OF H<sub>2</sub>S EXPOSURES

Hydrogen Sulfide (H<sub>2</sub>S) enters the body through inhalation. It is:

- a toxic, colorless gas which has the odor of rotten eggs at low concentrations
- soluble in water
- highly flammable
- heavier than air

Health effects of exposure to H<sub>2</sub>S can include:

- at low concentrations – headache, nausea, fatigue, dizziness, shortness of breath, cough; skin, eye and throat irritation; and/or loss of sense of smell
- at high concentrations – shock, convulsions, inability to breathe, unconsciousness or death

H<sub>2</sub>S may be present in various work locations or circumstances, such as:

- open systems
- when present as a free or released product
- in a sump or tank, especially when open to atmosphere (e.g., H<sub>2</sub>S may release into the air when the contents in the sump or tank bottoms is stirred)

H<sub>2</sub>S has poor warning properties. Olfactory (sense of smell) fatigue can occur with prolonged exposure to low concentrations (less than 100 ppm) or acutely at high concentrations (greater than 100 ppm).

### 6.5.2 PREVENTION OF BENZENE EXPOSURES

Benzene is a type of hydrocarbon that may be present in a variety of crude oil and chemical products. Benzene is:

- extremely toxic, with carcinogenic properties; it can enter the body through inhalation, ingestion and skin absorption
- a clear, colorless liquid with a pleasant, sweet odor; the odor, however, does not provide adequate warning of its presence as a hazard
- highly flammable, with a low flash point
- as a vapor is heavier than air, and can form explosive mixtures
- as a liquid is not soluble in water and will float (as it is lighter than water)

Health effects of exposure to benzene can include:

- moderate to severe irritation to the skin, and eyes, and mucous membranes
- aspiration

Short-term exposure to high concentrations of benzene may lead to gastrointestinal and neurological toxicity.

Long-term exposures of benzene, even at low concentrations, may lead to blood disorders such as anemia or leukemia and other cancers.

The 8-hour Threshold Limit Value (TLV) for benzene is 0.5 ppm, and the Short-Term Exposure Limit (STEL) for benzene is 2.5 ppm.

Benzene exposure may be found in the following locations and situations:

- gasoline and petroleum pipelines
- pipeline valve assemblies
- tank repair, maintenance and cleaning operations
- field maintenance operations

- bulk terminals and service station operations
- any open system operations
- lab operations
- leak sites and free/released product

In addition to other appropriate controls or measures, follow these controls for benzene:

- continuous or periodic atmospheric monitoring and monitoring of benzene shall be conducted tasks where a potential for benzene exposure occurs
- signs shall be posted at entrances to any identified areas that contain benzene
- chemicals containing benzene shall be secondarily contained and have proper signage when not part of the Enbridge operating system
- food and drink should not be stored or consumed in areas where benzene is, or may be present; always wash hands prior to eating, drinking or smoking to reduce possible ingestion
- designated areas for use and storage of benzene shall be established

Where exposure to benzene above the Exposure Limit is known or suspected, appropriate work practices, engineering controls and PPE requirements shall be implemented.

### 6.5.3 PREVENTION OF OXYGEN DEFICIENCY

Normal air contains approximately 21% oxygen and 79% nitrogen. Oxygen deficient atmospheres occur when the percentage of oxygen drops below 19.5%.

Oxygen deficient atmospheres may occur in different circumstances or locations, such as:

- during purging operations
- when the use of CO<sub>2</sub> or Halon fire extinguishing systems displaces oxygen (as part of putting out the fire)
- in enclosed spaces, e.g., where the presence of petroleum vapors can lead to an oxygen deficiency

In other cases, the presence of petroleum vapors is not the issue. For example, in a sealed, cleaned tank, some oxygen is used up as the interior walls of the tank rust, creating an oxygen deficient atmosphere.

Health effects of being exposed to an oxygen deficient atmosphere include:

- deep and rapid breathing
- if the oxygen level goes as low as 16%, the effects progress to dizziness, rapid heartbeat, headache and a possible inability to move



- at 14% and lower, humans cannot survive

#### 6.5.4 NUISANCE DUSTS

Nuisance dusts are a common workplace air contaminant. Dusts can become a respiratory hazard to Workers when sufficient amounts of inhalable or respirable particulates are present in work space air.

Nuisance dusts can be generated by many commonly used work practices within Enbridge. Work practices can include, but are not limited to:

- abrasive blasting
- cutting and grinding

TLVs for inhalable and respirable particulates are 3 milligram per cubic meter (mg/m<sup>3</sup>) and 10 mg/m<sup>3</sup>, respectively.

Where worker exposure to nuisance dusts above a TLV is known or suspected specific work practices and control measure must be in place. This may include one or more of the following practices:

- dilution ventilation
- general or local exhaust ventilation
- RPE
- skin protective equipment or clothing
- dust suppression or wetting

#### 6.5.5 CADMIUM AND LEAD

Cadmium and lead are toxic metals commonly found in industrial paints and coatings. Because of their anti-rust and anti-fouling properties, cadmium and lead are often electroplated onto steel nuts, bolts, and rivets. Operations involving the removal of cadmium and lead paints may pose a significant exposure hazard.

Prior to commencing operations that involve the disturbance of painted surfaces in Enbridge facilities, determination of the presence or absence of lead and cadmium shall be conducted. If the presence of cadmium or lead is detected in painted materials, work practices and exposure control strategies outlined in the Cadmium and Lead Management Plan found in the GDL shall be strictly followed. Sampling of materials shall only be performed by a qualified person in accordance with the process.

For additional information, refer to the Cadmium and Lead Management Plan on the GDL.

### 6.5.6 WELDING FUMES

Jobs involving welding activities are known for generating high levels of welding fumes (either general welding fumes or specific metal fumes), which may pose a health hazard to the health of welders or other workers in the vicinity of the job. A combination of respiratory protection and ventilation is required to control hazards associated with welding fumes. If conditions allow, air sampling for welding fumes shall be implemented, the main target of the sampling will be welding activities performed inside of confined spaces to determine exposures to the following:

- total welding fumes
- chromium
- chromium VI
- nickel
- manganese

### 6.5.7 CRYSTALLINE SILICA

When workers chip, cut, drill, or grind objects that contain crystalline silica (such as concrete cutting) it can become a respiratory hazard.

Crystalline silica (refractory materials) is found in materials commonly used to insulate crude oil heaters including:

- insulating Firebrick and Insulating Castable, which break down through the normal cycling of the heater and the turbulent flue gas, creating dusts that are disturbed on entry
- Kaowool Blanket Products, which may contain crystalline silica after being exposed to temperatures above 982°C (1800°F) (Such temperatures are not unusual during normal operation of the crude oil heaters)

Specific work practices and control measure must be in place when engaging in work that involves exposure to crystalline silica. Review the Crystalline Silica Management Plan found in the GDL prior to any work where exposure to crystalline silica is known or suspected.

For additional information, refer to the Crystalline Silica Management Plan on the GDL.

## 6.6 NITROGEN (PIPELINE PURGING)

Nitrogen is a colorless, odorless, relatively inert gas. Nitrogen is used to purge product from the pipeline in preparation for certain work activities.

Once the pipeline is purged, excess nitrogen is vented (i.e., the pipeline is depressurized) and residual nitrogen remains in the pipeline.

To reduce risks of exposure, consider the following factors and hazards:

- Increasing the nitrogen concentration in air lowers the oxygen concentration. If the concentration of nitrogen is too high (and oxygen too low), a person will become oxygen deprived and simple asphyxiation occurs.
- Nitrogen is usually transported and stored in liquid form. Always use nitrogen in a well-ventilated area.
- The transition from liquid to gas can generate a lot of pressure quickly, which causes cold temperatures. Liquid nitrogen is extremely cold and can cause severe frostbite upon contact.
- Cold nitrogen gas is heavier than air, so the risk of exposure to nitrogen is greatest in low lying areas, e.g., excavations, tank berms, vaults and culverts.

### 6.6.1 SITE PREPARATION / WORK CONTROLS

To reduce potential exposures to nitrogen, use controls such as:

- install a windsock, for monitoring wind direction
- ensure SCBA (2 minimum) and fire extinguishers are readily available
- always position liquid nitrogen trucks/tanks, injection equipment and blowdown tanks in well-ventilated areas (to prevent accumulation of excessive concentrations of nitrogen)
- install piping or hoses to vents and locate discharge ends downwind away from work area; inform workers to stay clear
- ensure workers wear hearing protection during nitrogen injection and venting activities
- ensure workers wear appropriate eye/face protection, RPE, insulated gloves and body protection as needed, when handling or operating purging equipment

Workers not directly involved in nitrogen purging activities shall stay upwind, out of the work area and in designated safe zones.

### 6.7 HEARING CONSERVATION

Workers who are exposed to noise at 82 dBA or above shall wear hearing protection. Enbridge shall ensure appropriate hearing protection is provided and available to workers at each worksite, and that the protection is properly used and maintained, in accordance with manufacturer's specifications.

Enbridge shall carry out hearing conservation measures for employees exposed to noise at levels:

- Greater than or equal to ( $\geq$ ) 82 dBA of an 8 hr. TWA; or
- Greater than ( $>$ ) 115 dBA at any time

Contractors shall have a hearing conservation program where required and are responsible for providing their employees with the required testing and any required hearing protection.

**Uncontrolled Copy if Printed or Downloaded**

Enbridge is responsible for the following hearing conservation measures for Enbridge employees:

- Coordinating hearing conservation training as required,
- Identifying potential noise hazards (e.g., new equipment, noise sources) or changes that may affect noise exposure assessments,
- Ensuring noise-hazardous areas and equipment are identified, including areas where additional hearing protection is required, and
- Identifying and implementing engineering controls to reduce noise levels, wherever practicable.

### **6.7.1 AUDIOMETRIC TESTING**

Enbridge shall be responsible for the following, for employees:

- Arranging audiometric testing with the testing agency, including initial, ongoing and follow-up testing or evaluation when required,
- Participating in reviewing abnormal test results, as necessary,
- Providing workers with forms and information needed for audiometric testing (in the US the testing agency provides workers with forms and information needed).

All workers are responsible for:

- Attending audiometric testing as required,
- Following up with their personal physician if abnormal test results are received from the testing agency, and
- Attending follow-up tests or other medical evaluation if required by the testing agency, Enbridge health services or the worker's personal physician.

All audiometric tests for Enbridge employees shall be paid for by Enbridge and workers shall be granted time off during normal working hours to attend appointments.

The Enbridge Health & Safety Department is responsible for:

- Conducting noise exposure assessments and re-assessments and recommending hazard controls as required,
- Assisting in selecting, fitting and using appropriate hearing protection,
- Ensuring employee audiometric test result records are provided to the testing agency for ongoing testing,
- Liaising with Enbridge's health services, testing agency, regional safety advisor and worker regarding test result records including safety concerns and any follow-up testing or further evaluation required,

- Maintaining summaries of audiometric test results for Enbridge employees in Canada (US Human Resources maintains summaries of US workers' audiometric test results), and
- Reviewing abnormal test results where there is a safety concern (Canada).

### 6.7.2 ADDITIONAL HEARING PROTECTION MEASURES

Noise exposure assessments for workers are recommended when:

- There are indicators that noise levels from equipment or other sources are:
  - Greater than or equal to ( $\geq$ ) 82 dBA of an 8 hr. TWA; or
  - Greater than ( $>$ ) 115 dBA at any time
- There has been a change that may make the hearing protection inadequate (e.g., equipment changes; changes to job tasks or worker assignments, such that use of hearing protection needs to be reviewed), and
- Audiometric testing of a worker shows there is a Standard Threshold Shift (STS).

Areas and fixed equipment with noise levels greater than ( $>$ ) 82 dBA shall be identified and marked with posted signs.

Hearing protection shall be worn as follows:

- In work areas where hearing protection signage is posted, when equipment is operating,
- When operating any piece of equipment where the noise level is greater than ( $>$ ) 82 dBA
- When exposed to noise levels greater than or equal to ( $\geq$ ) 105 dBA, workers shall wear both ear plugs and ear muffs, and
- When an arc flash hazard exists, workers shall wear ear canal inserts (i.e., ear plugs).

Enbridge provides approved hearing protection for employees at all Enbridge locations. For assistance in selecting appropriate hearing protection, contact the Health & Safety Department.

All new workers who may be exposed to noise hazards at greater than or equal to ( $\geq$ ) 82 dBA shall receive a baseline audiometric test within 6 months of being hired.

Prior to establishing a baseline audiogram for a worker, the worker shall have gone at least 14 hours without being exposed to workplace noise.

If a Standard Threshold Shift has occurred the worker shall to be notified in writing within 21 days of the determination.

In addition to baseline testing, workers who continue to be exposed to workplace noise shall receive annual audiometric testing. If regulatory requirements are more stringent, they shall be followed.

Additional testing may be requested by health services (retained by Enbridge), the testing agency or the employee's physician.

Records shall be maintained according to Enbridge's Record Management Policy and Records Retention Schedule in the following locations:

- Enbridge Worker Audiometric Testing Results,
  - Enbridge-contracted occupational health nurse [CAN],
  - Testing agency [USA].

Audiometric test results are confidential. Results are accessible only to Enbridge's health services and the worker tested, unless the worker provides written consent to disclose the results to a third party or if disclosure is required by law.

## 7.0 TRAINING REQUIREMENTS

Personnel working in the field must be knowledgeable in this Standard and may be assigned applicable training as driven by the Safety Training Matrix.

Reference the Health & Safety training syllabi and matrices for further information and training re-certification requirements.

## 8.0 RELATED DOCUMENTS

Asbestos Management Plan

Cadmium and Lead Management Plan

Crystalline Silica Management Plan

Radiation Safety Standard

## 9.0 STANDARD REVIEW

A subject matter expert (SME) will perform a technical review of this standard every two years to determine the accuracy of the content/information. The SME shall solicit input from applicable stakeholders to ensure the effectiveness of the standard. Any suggested changes must be reviewed and approved by the designated document owner.

## 10.0 REFERENCES

Canada Labour Code, Part II

Canadian Occupational Health & Safety (COHS) Regulations

CSA Z662 - Oil and Gas Pipeline Systems

Employee Exposure and Medical Records, 29 CFR 1910.1020

National Fire Code, Part 5 (referenced by Canada Labour Code, Part II)

---

Occupational Safety and Health Administration (OSHA)

SOR/2015-17 - Hazardous Products Regulations

Transportation of Dangerous Goods (TDG) regulations

Workplace Hazardous Materials Information System (WHMIS) regulations



**CHANGE LOG**

Section	Version 1.3	Version 1.4										
Entire document		Clerical corrections including spelling, grammar, and document names.										
6.7	Workers who are exposed to noise at 85 dBA or above shall wear hearing protection.	<p><i>Changed to align with Hearing Loss Prevention &amp; Noise Control Plan.</i></p> <p>Workers who are exposed to noise at 82 dBA or above shall wear hearing protection.</p>										
6.7.2	<p>Hearing protection shall be worn as follows:</p> <ul style="list-style-type: none"> <li>• In work areas where hearing protection signage is posted, when equipment is operating,</li> <li>• When operating any piece of equipment where the noise level is greater than (&gt;) 85 dBA,</li> </ul> <p>All new Workers who may be exposed to noise Hazards at greater than or equal to (<math>\geq</math>) 85 dBA shall receive a baseline audiometric test within 6 months of being hired.</p> <p>In addition to baseline testing, Workers who continue to be exposed to workplace noise shall receive ongoing audiometric testing. according to the following table. If regulatory requirements are more stringent, they shall be followed.</p> <table border="1" data-bbox="349 1541 816 1688"> <thead> <tr> <th></th> <th>Canada</th> <th>USA</th> <th>EPSI</th> <th>APLI</th> </tr> </thead> <tbody> <tr> <td>Frequency</td> <td>5 years</td> <td>1 year</td> <td>2 years</td> <td>2 years</td> </tr> </tbody> </table>		Canada	USA	EPSI	APLI	Frequency	5 years	1 year	2 years	2 years	<p><i>Changed to align with Hearing Loss Prevention &amp; Noise Control Plan.</i></p> <p>Hearing protection shall be worn as follows:</p> <ul style="list-style-type: none"> <li>• In work areas where hearing protection signage is posted, when equipment is operating,</li> <li>• When operating any piece of equipment where the noise level is greater than (&gt;) 82 dBA,</li> </ul> <p>All new workers who may be exposed to noise hazards at greater than or equal to (<math>\geq</math>) 82 dBA shall receive a baseline audiometric test within 6 months of being hired.</p> <p>In addition to baseline testing, workers who continue to be exposed to workplace noise shall receive annual audiometric testing. If regulatory requirements are more stringent, they shall be followed.</p>
	Canada	USA	EPSI	APLI								
Frequency	5 years	1 year	2 years	2 years								

<End of Document>





---

# Standard

---

## Inspection

---

**Effective Date:** 2019-03-30  
**Version #:** 1.6  
**Version Date:** 2024-03-28

---



This page intentionally left blank



**Document Version Register**

Version Number	Version Date	Approved By	Section Number and Title	Details of Version
1.0	2019-03-30	Sean Evans	Whole Document (New Standard)	This is the new H&S standard that was developed as part of the LP   MP Safety Manual Transition Project
1.1	2019-10-31	Sean Evans	6.0, Standard-Specific Requirements	Updated Facility Inspection Frequency requirements
1.2	2021-12-01	Murray Evenson	9.0, 10.0	Updated section 9 to reflect the appropriate review process Added reference to section 10.0
1.3	2022-07-19	Jeff Safioles	6.1.1	See change log for details
1.4	2022-08-18	Murray Evenson	6.0	See change log for details
1.5	2023-12-07	Jeff Safioles	6.0, 6.1	See change log for details
1.6	2024-03-28	Troy Croft	All sections 4.0	Clerical corrections Alignment with Management System Framework - Event Analysis.



This page intentionally left blank



---

## **Table of Contents**

1.0 Purpose .....	2
2.0 Scope .....	2
3.0 Prerequisites.....	2
4.0 Definitions & Acronyms .....	3
5.0 Roles & Responsibilities.....	3
6.0 Standard – Specific Requirements.....	5
6.1 Inspection Process .....	6
6.1.1 Focused Inspections.....	8
6.2 Inspection Database/Repository.....	8
6.2.1 Encompass Workflow and User Roles .....	9
7.0 Training Requirements .....	9
8.0 Related Documents .....	10
9.0 Standard Review .....	10
10.0 References .....	10
Change Log.....	11

---

## **1.0 PURPOSE**

The Standard provides direction on how to complete the self-assessment inspection process required within LP Operations and projects being completed for LP.

## **2.0 SCOPE**

This standard applies to LP Operations and Projects being completed for LP.

This Standard applies to inspections for all facilities including administrative and regional offices, remote maintenance bases (NW), attended and unattended facilities as well as other locations owned and operated by Enbridge (i.e. warehouses and project sites).

Contractors and subcontractors shall comply with Enbridge health and safety requirements set out in this standard. If a contractor or subcontractor has a health and safety standard or policy materially different from Enbridge's, the contractor/subcontractor shall follow the most stringent requirement. Contractors and subcontractors are still obligated to meet the requirements of all applicable laws related to this standard.

In the event a contractor's or subcontractor's standard exceeds the requirements of this standard, Enbridge may, in its sole discretion, choose to adopt the contractor's or subcontractor's standard for any given contract or work order.

## **3.0 PREREQUISITES**

Bloodborne Pathogens Standard

Confined Space Entry Standard – Canada/ US

Control of Hazardous Energy Standard

Electrical Safety Standard

Emergency Preparedness – Personal Safety Standard

Fall Protection Standard

Hazard Communication & WHMIS Standard

Personal Protective Equipment Standard

Powered Mobile Equipment Standard

Right to Refuse Unsafe Work Standard

Safe Work Permitting & Work Authorization Standard

Storage and Transportation of Hazardous Materials Standard

Tools and Equipment Standard

Vehicle Operations Standard

## 4.0 DEFINITIONS & ACRONYMS

*Administrative Office Inspection*—an office inspection completed on any of the following administrative office locations: Edmonton, Calgary, Superior, Edina & Duluth.

*Field Inspection*—A facility (attended or unattended), remote maintenance base (NW), warehouse and/or regional office inspection.

*Focused Inspection*—is a formalized and properly documented process of focusing in on the identification of a specific hazard or substandard conditions that have a high potential for causing serious injury and or fatalities at a workplace. They are generally driven by findings from a previous inspection or incident (for example, an Inspection Lead reports a recent inspection found that fall protection equipment was not being inspected as required. The Safety Team, as part of the corrective action, would assign a focused inspection to be completed across all Regions and Projects to ensure this critical practise is not being overlooked across the organization). An inspection lead is assigned for each regularly scheduled or ad hoc focused inspection and formal training is required.

*Inspection*—is a formalized and properly documented process of visually identifying hazards, implementing assigned corrective actions and reviewing for potential trends. The process strictly focuses on identifying and treating substandard conditions within a facility or an office setting using pre-identified checklist and supporting guideline document and does not have an interview component. An inspection lead is assigned for each regularly scheduled inspection and formal training is required.

## 5.0 ROLES & RESPONSIBILITIES

People Leaders shall:

- Ensure that the employee assigned to the role of inspection lead has the appropriate training and qualifications to effectively perform the inspection;
- Support inspection lead with stopping all work associated with all inspection findings that represent an immediate danger to workers;
- Work with appropriate inspection lead and Health & Safety Team to develop effective corrective actions for all deficient findings;
- Assign personnel to correct all deficiencies found within the inspection findings;
- Ensure all documents are entered into EnCompass and retained on file as per the integrated management document retention requirements;
- Be knowledgeable and compliant to this standard; and
- Advise affected workers of any unsatisfactory inspection results and hazards that have not been controlled or eliminated.

---

Inspection leads shall:

- Complete all required training prior to executing a facility or office inspection;
- Be knowledgeable in applicable safety, security and environmental regulations for determining substandard conditions within an office or facility setting;
- Organize and coordinate members of the inspection team (as required);
- Conduct physical inspections of facilities and worksites;
- Immediately stop work when a deficiency or hazard is determined to provide an immediate danger to workers;
- Work with appropriate people leader and Health & Safety Team to develop effective corrective actions for all deficient findings; and
- Conduct inspection debrief for appropriate people leader and Health & Safety Team and ensure inspection results, findings, and corrective actions are entered into the Encompass tool.

Action plan owners shall:

- Monitor and manage the assignment and timely completion of preventative and corrective tasks.

Safety Team shall:

- Provide timely advice, support and assistance to people leaders and inspection leads in the implementation of this standard;
- Work with appropriate people leader and inspection lead to develop effective corrective actions for all deficient findings;
- Recommend if focused inspections are required based on deficiency findings from completed inspections; and
- Perform the role of inspection lead as assigned.

Safety Shared Services shall:

- Be responsible for the maintenance and continuous improvement of this standard;
- Adminstrate and continuously improve the system used for planning, tracking and recording inspection results (e.g., EnCompass);
- Maintain and upkeep resources and training materials associated with the use of the inspection tool;



- Provide metrics and reporting services and support to region and project stakeholders associated with inspection activities; and
- Govern inspection checklists and facilitate their revisions and updates.

## 6.0 STANDARD – SPECIFIC REQUIREMENTS

Inspections must be completed as identified by the minimum frequency schedule detailed below:

Location	Minimum Inspection Frequency
Attended Facility	Annually
Unattended Facility	Semi-annually
Remote Maintenance Base (NW)	Three times per year
Regional Office	Annually
Project	If applicable, and if so, as determined by Project Director & Project Safety Team

The elements involving security in the inspection within projects will be completed regularly as determined by the project safety representative and the applicable Enbridge Security representative.

Note: The overall facilities must be completed at the minimum frequency. It's recommended for larger sites that the inspections be broken down into smaller segments which can be managed quarterly or more frequently, as appropriate.

There are inspection requirements located in the Operations and Maintenance Manuals including but not limited to:

- Smoke Detectors
- First Aid Equipment
- Fire Extinguishers Inspection
- Light Duty Recreational Vehicles
- SCBA

Administrative office inspections must be completed as identified by the minimum frequency schedule detailed below:

Type of Inspection	Minimum Inspection Frequency	Designated Inspection Lead
Quarterly Floor Inspection	Quarterly	Emergency Warden
First Aid Kit Inspection	Monthly	Emergency Warden
AED Inspection	Monthly	Emergency Warden

**6.1 INSPECTION PROCESS**

Field inspections and administrative office inspections are to be completed by following the detailed process below.



Step #	Process Step	Description
1	Appoint an Inspection Lead	<p>People Leader:</p> <ul style="list-style-type: none"> <li>Select the most appropriate person to conduct the inspection.</li> </ul>
2	Plan the inspection.	<p>Designated Inspection Lead:</p> <ul style="list-style-type: none"> <li>Formulate a plan for conducting the inspection.</li> <li>Select and appoint an assistant or team if warranted.</li> <li>Review past inspections at the location and make note of any deficiencies that should have been addressed in the previous period.</li> <li>Assign categories that each team member should focus on when inspecting as a team.</li> <li>Identify and contact the local point of contact (i.e., People Leader)</li> </ul>
3	Perform the inspection.	<p>Designated Inspection Lead:</p> <ul style="list-style-type: none"> <li>Execute inspection plan.</li> <li>Note any observed deficiencies.</li> <li>Request any serious safety and security infraction be addressed immediately.</li> <li>Record the condition observed and the location.</li> <li>Consult with Regional safety personnel or regional ER &amp; Security Coordinator if necessary.</li> </ul>
4	Identify deficiencies or hazards.	<p>Designated Inspection Lead:</p> <ul style="list-style-type: none"> <li>Identify serious deficiencies or hazards in the area while conducting the inspection.</li> </ul>
5	Dangerous conditions identified?	<p>Designated Inspection Lead:</p> <ul style="list-style-type: none"> <li>Did the inspection identify any serious deficiencies or potentially hazardous conditions that could be immediately dangerous to life or health?</li> <li>— If “yes”, go to step 6, “Stop all work”</li> <li>— If “no”, go to step 7, “Immediate corrections required?”</li> </ul>
6	Stop all work.	<p>Designated Inspection Lead:</p> <ul style="list-style-type: none"> <li>Stop all work that may be immediately dangerous to life or health.</li> <li>Notify appropriate People Leader</li> </ul>
7	Immediate corrections required?	<p>Designated Inspection Lead</p> <ul style="list-style-type: none"> <li>Determine if immediate corrective actions are required.</li> <li>— If “yes”, go to step 8 “Dispatch personnel to correct the deficiency/ hazard”</li> <li>— If “no”, go to Step 9 “Review findings and draft report”</li> </ul>
8	Assign personnel to correct the deficiency/ hazard.	<p>Designated Inspection Lead:</p> <ul style="list-style-type: none"> <li>Communicate with appropriate People Leader to correct the deficiency/ hazard.</li> </ul>

9	Conduct debrief	Designated Inspection Lead: <ul style="list-style-type: none"> <li>Review findings of the inspection with appropriate People Leader(s) and consult on the appropriate assignment of corrective actions.</li> </ul>
10	Document Inspection report.	Designated Inspection Lead: <ul style="list-style-type: none"> <li>Record the inspection results, findings and corrective actions in EnCompass.</li> <li>Issue the inspection record for review and closure.</li> </ul>
11	Follow up	Inspection Action Plan Owner <ul style="list-style-type: none"> <li>Verify completion and documentation of assigned corrective actions</li> </ul>

All equipment inspections located within the Operational and Maintenance Manuals are to be completed as determined by applicable job plan. Please see your people leader for more information.

### 6.1.1 FOCUSED INSPECTIONS

A focused inspection is a formalized and properly documented process of targeting specific hazard or substandard conditions that have a high potential for causing serious injury and or fatalities at a workplace.

Focused inspections may be completed ad hoc based on facility inspection or industry trends. For example, an industry alert detailing a recall on a specific coupling within a supplied air unit would instigate a focused inspection across all regions and projects to ensure the recalled equipment was not currently in use at Enbridge worksites.

During verification activities, if valves and equipment labels are missing or labelled incorrectly according to the P&ID, ensure to document within the EnCompass Inspection platform, with associated action plan for resolution prior to any work being performed on the mislabeled equipment. Refer to section '6.6 – Lockout/Tagout Assurance Process for Asset Management' in the Control of Hazardous Energy Standard.

## 6.2 INSPECTION DATABASE/REPOSITORY

In EnCompass both the audit module and action plan module will be used during the inspection process, serving as a common central system/tool to facilitate the planning, performance, and documentation of inspections and their results. EnCompass will be used towards satisfying company and regulatory requirements for:

- Evidencing an established, implemented and formal process for inspecting and monitoring the company's facilities for hazards and potential hazards,
- Evidencing inspection occurrences per schedule along with their results and findings,

- Retaining documentation and records associated with inspection activities,
- Recording, managing and ensuring completion of corrective and preventative actions established to resolve deficiencies, and
- Maintaining a data management system to aid in monitoring and analyzing hazards.

**6.2.1 ENCOMPASS WORKFLOW AND USER ROLES**

EnCompass will facilitate inspection activities through three workflow phases (draft/plan, perform, review) mirroring the general inspection process. Various individuals are assigned roles within the inspection workflow and are each responsible for a set of system related activities.

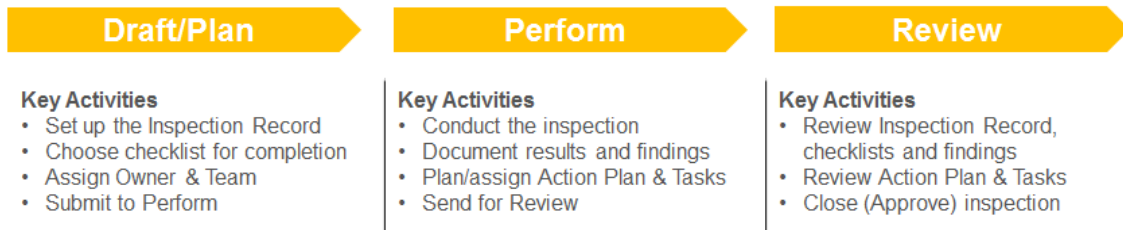

Role	Comments	Active During
<b>Inspection Coord. / Creator</b> <i>(optional)</i>	<ul style="list-style-type: none"> <li>• Creates inspection records ahead of time (per schedule)</li> <li>• Pre-populates forms and assigns the owner</li> <li>• Reassign owner as required</li> </ul>	Draft/Plan
<b>Owner</b> <i>(Inspection Lead)</i>	<ul style="list-style-type: none"> <li>• Creates new inspection records (as needed)</li> <li>• Accountable for:                             <ul style="list-style-type: none"> <li>✓ Leading the inspection activity</li> <li>✓ Correctly documenting the activity and results (EnCompass)</li> <li>✓ Creating and assigning the action plan and tasks to correct deficiencies (EnCompass)</li> </ul> </li> </ul>	Draft/Plan  Perform
<b>Team Member</b>	<ul style="list-style-type: none"> <li>• Can update inspection records and checklists for which they are a team member</li> </ul>	Perform
<b>Reviewer</b>	<ul style="list-style-type: none"> <li>• Reviews in EnCompass:                             <ul style="list-style-type: none"> <li>• Inspection details</li> <li>• Findings</li> <li>• Action Plan &amp; Tasks to ensure deficiencies will be corrected.</li> </ul> </li> <li>• Approves/Rejects that completed inspection record</li> </ul>	Review

**7.0 TRAINING REQUIREMENTS**

Personnel working in the field must be knowledgeable in this Standard and may be assigned applicable training as driven by the Safety Training Matrix.

The inspection lead and all subsequent inspection team members must have the required Enbridge and site specific orientations and any safety training required to safely perform the inspection (i.e. Gas Detection, Electrical Awareness).

- Reference the Health & Safety training syllabi and matrices for further information and training recertification requirements.

An inspection team for a field inspection (a designated inspection lead and/or a member) must have combined knowledge in applicable federal and provincial/state occupational health and safety legislation as well as the applicable listed prerequisite standards.

Personnel performing focused inspections must be knowledgeable and trained to safely perform the inspection prior to commencement.

- Reference the Health & Safety training syllabi and matrices for further information and training recertification requirements.

## 8.0 RELATED DOCUMENTS

Administrative Office AED Inspection Form

Administrative Office Annual Floor Inspection Form

Administrative Office First Aid Kit Inspection Form

Administrative Office Quarterly Floor Inspection Form

EHS Facility Inspection Checklist

EnCompass Facility Inspection Quick Reference Guides

EnCompass Facility Inspection Training Presentation

EnCompass Step By Step Tool Reference

Facility Inspection Guidelines

Security Management Plan

## 9.0 STANDARD REVIEW

A subject matter expert (SME) will perform a technical review of this standard every two years to determine the accuracy of the content/information. The SME shall solicit input from applicable stakeholders to ensure the effectiveness of the standard. Any suggested changes must be reviewed and approved by the designated document owner.

## 10.0 REFERENCES

SOR/99-294 - Canadian Energy Regulator Onshore Pipeline Regulations

06.5 (1) (u) Management System Processes



---

## CHANGE LOG

Section	Version 1.5	Version 1.6
6.1	All description detail in italics apply to field inspections only and administrative office inspections are exempt from the requirement.	Removed wording
Entire document		
4.0		Updated terminology from incident and investigation to event and analysis to align with Management System Framework - Event Analysis.

<End of Document>



---

# Standard

---

## Lessons Learned

---

**Effective Date:** 2019-03-30  
**Version #:** 4.1  
**Version Date:** 2024-03-28

---





This page intentionally left blank



**Document Version Register**

Version Number	Version Date	Approved By	Section Number and Title	Details of Version
1.1	2017-07-01	Sean Evans	Entire Document	New Guidance Document for MOC Review (July 2017) – B. Burlock
2.0	2018-02-09		Entire Document	Alignment with IMS04 Rewrite into Safety Management Program
3.0	2019-03-30		Entire Document	Alignment to centralized S&R structure
3.1	2021-12-01	Murray Evenson	8.0, 9.0	Updated section 8 to reflect the appropriate review process Added references to section 9.0
4.0	2022-01-17	Murray Evenson	Entire Document	Clarification to roles and responsibilities, wording and addition of process flow.
4.1	2024-03-28	Troy Croft	All sections 5.5	Clerical corrections; Alignment with Management System Framework - Event Analysis. Removal of SLIA reference



This page intentionally left blank

---

## Table of Contents

1.0	Purpose .....	6
2.0	Scope .....	6
3.0	Definitions & Acronyms .....	6
4.0	Roles and Responsibilities .....	7
5.0	Standard-Specific Requirements .....	10
5.1	Identification of Lessons Learned.....	10
5.2	Stakeholder Identification .....	10
5.3	Lessons Learned Communication Methods .....	11
5.3.1	Communication Channels.....	12
5.3.2	Safety & Reliability Lessons Learned Repository on ELink (searchable archive for SR lessons Leaned) Alerts .....	12
5.3.3	High Value Learning Event.....	12
5.3.4	Lessons Learned Toolbox Talk .....	13
5.3.5	Stand Downs .....	13
5.3.6	Virtual Tailgate.....	13
5.3.7	Quality Bulletin.....	13
5.3.8	Lessons Learned Infographics .....	13
5.4	Legal Considerations .....	14
5.4.1	No Personal (or Other Identifying) Information of Individuals.....	14
5.4.2	No Cost/ Operational Impact Information .....	14
5.4.3	Regulatory and Internal Event Analyses/ Regulatory and Civil Proceedings.....	14



---

6.0	Training Requirements .....	15
7.0	Related Documents .....	15
8.0	Standard Review .....	15
9.0	Reference .....	16
10.0	Appendix.....	16
10.1	Lessons Learned Process Flow .....	16
10.2	Process Flow Description: .....	17
	Change Log.....	18

## 1.0 PURPOSE

Enbridge's Management System Framework, Safety & Reliability Policy and our Safety Principles support the sharing of lessons learned as a critical part of continuous improvement and strengthening of our overall safety and reliability culture. A key step in the prevention of events is learning from previous occurrences. This Standard provides a consistent approach to communicating learnings from:

- events that occur during work-related activities within Enbridge operations or projects, or
- events that have the potential to occur at any Enbridge worksite or administrative office, or
- events from similar industries or organizations from external to Enbridge, or
- off-the-job events that have the potential to affect the health, safety and wellness of our employees, contractors, communities and the environment.

## 2.0 SCOPE

This standard applies to all employees, contractors and subcontractors directly supporting Enbridge activities. Contractors and subcontractors shall comply with Enbridge requirements set out in this Standard. If a contractor or subcontractor has a standard or policy materially different from Enbridge's, the contractor/subcontractor shall follow the most stringent requirement. Contractors and subcontractors are still obligated to meet the requirements of all applicable laws related to this Standard.

In the event a contractor's or subcontractor's standard exceeds the requirements of this standard, Enbridge may, in its sole discretion, choose to adopt the contractor's or subcontractor's standard for any given contract or work order.

## 3.0 DEFINITIONS & ACRONYMS

*A&D* – Alcohol & Drug

*Business Unit*—An autonomous division of an enterprise that operates as an independent enterprise with responsibility for a particular range of assets. For Enbridge Inc., the Business Units are as follows:

- Gas Transmission & Midstream
- Liquids Pipelines
- Gas Distribution & Storage
- Power Operations
- Corporate\*

- Projects\*

\*Corporate and Projects support the above listed Business Units but also operate as independent autonomous divisions and therefore are considered as unique Business Units.

*External*—distributing or receiving lessons learned outside of Enbridge from contractors and industry associations and/or partners.

*HVLE* – High Value Learning Event

*IMS SME (Integrated Management System Subject Matter Expert)*—are subject matter experts from the quality, environment, safety departments who can assist in facilitation of identification and development of lessons learned.

*Event*—an unplanned occurrence that results or could result in a significant adverse effect on property, the environment, and/ or the safety of a person.

*Lessons learned*—capture the knowledge learned during the course of business, or while implementing projects with the goal of identifying and addressing selected opportunities for improvement. Actions taken help to encourage the recurrence of positive outcomes while deterring undesirable ones.

*Tailgate meeting*—Tailgate meetings are small informal pre-job meetings, like a pre-work huddle. Similar to department safety meetings and leadership meetings, tailgate meetings provide People Leaders with the opportunity to review recent Lessons Learned and safety of upcoming work.

## 4.0 ROLES AND RESPONSIBILITIES

The roles and responsibilities identified are assigned leveraging the Decision Effectiveness RAPID model: **R**ecommend, **A**gree, **P**erform, **I**nput, **D**ecide. See training and resources on [ELink](#).

**See Process Flow in Appendix 10.1 and Process Flow Description 10.2 for guidance on how to create Lessons Learned**

Role	Responsibilities
<p><b>R/P</b> Event People Leader</p>	<ul style="list-style-type: none"> <li>• Collaborate with IMS Program SME and event analysis team                             <ul style="list-style-type: none"> <li>• Determine if lessons learned communication is required</li> <li>• Determine lessons learned method and channel</li> <li>• Determine scope of communication distribution</li> </ul> </li> <li>• Support the draft of the lessons learned communication and participate in review</li> </ul>
<p><b>R/P</b> Integrated Management System (IMS) Program Subject Matter Experts (SMEs)</p> <p>(i.e., accountable area SMEs in Safety, Environment, Compliance, or Quality.)</p>	<ul style="list-style-type: none"> <li>• Collaborate with event people leader and event analysis team                             <ul style="list-style-type: none"> <li>• Determine if lessons learned communication is required</li> <li>• Determine lessons learned method and channel</li> <li>• Determine scope of communication distribution</li> </ul> </li> <li>• Draft lessons learned communication</li> <li>• Facilitate review, approvals and publication with:                             <ul style="list-style-type: none"> <li>• Legal services, Management Review, Shared Services</li> </ul> </li> <li>• Ensure quality of lessons learned documents</li> <li>• Monitor effectiveness of lessons learned communication</li> <li>• Provide timely communications, advice and support to people leaders in implementing the Lessons Learned Process to drive change and embed learnings resulting from an event</li> <li>• Maintain appropriate contact with industry committees and associations that provide information on relevant events that have occurred outside our organization and share the learnings in accordance with this document.</li> </ul>
<p><b>A</b> Accountable Area SME Manager (e.g. Safety, Environment, Quality, Compliance Managers)</p>	<ul style="list-style-type: none"> <li>• Provide direction and agree to the identified Lessons Learned communication</li> <li>• Agree to the distribution of the Lessons Learned communications</li> </ul>
<p><b>A</b> Event Area Director (e.g., regional director)</p>	<ul style="list-style-type: none"> <li>• Provide direction and agree to the identified Lessons Learned communication</li> <li>• Agree to distribution of the Lessons Learned communications</li> </ul>
<p><b>D</b> Director Accountable (or designate) for Lessons Learned Communication (i.e., Safety, Compliance or Quality)</p>	<ul style="list-style-type: none"> <li>• Provide approval for distribution of Lessons Learned including external distribution as appropriate after Legal review has been completed.</li> </ul>



<p><b>I</b> Program Owner(s)</p>	<ul style="list-style-type: none"> <li>• Monitor and assess the effectiveness of Lessons Learned Standard implementation and quality of the lessons learned.</li> <li>• Ensure continuous improvement of this standard.</li> <li>• Support the implementation, development and distribution of Lessons Learned.</li> <li>• Provides quality checks and effectiveness of lessons learned as required.</li> </ul>
<p><b>P/I</b> Safety Shared Services</p>	<ul style="list-style-type: none"> <li>• Support the development, review and/or distribution of safety lessons learned documents</li> <li>• Ensure quality of lessons learned documents for safety events</li> <li>• Ensure lessons learned documents are captured and uploaded on the Safety and Reliability Lessons Learned repository that is readily available to all Business Units</li> <li>• Monitor effectiveness of lessons learned communications</li> <li>• Provide timely communications, advice and support to people leaders in implementing the Lessons Learned Process to drive change and embed learnings resulting from an event</li> </ul>
<p><b>R/P</b> Quality</p>	<ul style="list-style-type: none"> <li>• Draft, review, and issue “Quality” lessons learned and/or Quality Bulletins as outcomes from quality related event analyses using internal processes</li> <li>• Participate or contribute in the safety or process safety related event analyses to ensure quality related aspects or contributing cause(s) are addressed to prevent reoccurrence</li> <li>• Engage the right stakeholders as identified in this Standard to ensure collaborative approach during development, review, issuance and communication of high value lessons learned</li> </ul>
<p><b>A</b> Legal Services</p>	<ul style="list-style-type: none"> <li>• Review and provide counsel on communications as required</li> <li>• Timely review of lessons learned communications</li> </ul>
<p><b>P</b> People Leaders/Team Members</p>	<ul style="list-style-type: none"> <li>• Share Lessons Learned as appropriate with team.</li> <li>• Follow applicable corrective actions set out in the shared lessons learned documents</li> <li>• Participate in lessons learned reviews and examine the learning points contained in the shared information, offer input and feedback and consider the relevance of the learning points to their situation and environment</li> </ul>

## 5.0 STANDARD-SPECIFIC REQUIREMENTS

Learning through continual improvement activities, such as assessments, audits, and analyses, is used to increase workforce awareness and understanding. Learning from these activities greatly reduces potential event reoccurrence.

### 5.1 IDENTIFICATION OF LESSONS LEARNED

Identifying the lessons learned and sharing them across business units is critical to initiating measurable safety and reliability performance improvement for the organization. Lessons learned are attained from a variety of sources including but not limited to:

- Causes, corrective and preventative actions identified during event analyses
- Protection program verification assessments
- Internal and external audits
- Safety submissions
- Inspections
- Industry safety alerts and bulletins

If an individual believes there is value in sharing a specific learning outside of their department, the request is to be forwarded to their People Leader.

The People Leader will work with their IMS SME to determine the appropriate stakeholders that the learning needs to be shared with. Identified lessons learned will be facilitated by the appropriate Program Team to ensure quality and distribution of the learnings. Further guidance on identifying sharing opportunities is included in the following sections.

### 5.2 STAKEHOLDER IDENTIFICATION

For the purposes of this Standard, potential stakeholders that would be included in the sharing of the Lessons Learned would be grouped as follows:

- Local (specific departments or office location)
- Entire region or project
- Specific business unit(s)
- Enterprise
- External

Local lessons learned may be shared at the regional or project level per the approval of the Director Accountable for Event Ownership. However, Lessons Learned that are to be shared at the Business Unit, Enterprise and/or External level require approval from the Director who is accountable for communications.

### 5.3 LESSONS LEARNED COMMUNICATION METHODS

There are several ways to share event learnings across the organization and externally these include but are not limited to:

- Alerts
- High Value Learning Events (HVLE)
- Lessons Learned Toolbox Talks
- Stand-downs
- Virtual Tailgates
- Quality Bulletins
- Case Study Infographics

The table below provides direction on which method(s) are best suited for use based on the audience chosen for distribution.

Communication Method	Local	Region/Project	Business Unit(s)	Enterprise	External*
Alert	X	X	X	X	X
High Value Learning Event (HVLE)			X	X	X
Lessons Learned Toolbox Talk	X	X	X		
Stand-down	X	X	X		
Virtual Tailgate			X	X	
Quality Bulletin	X	X	X	X	
Case Study Infographics				X	
Program specific as required					

\*Externally shared communications must be reviewed and approved by Legal and Director accountable for communication.

The initiator of the communication will develop the communication based on the proposed scope and provide the proposed communication to the applicable department manager for distribution to the identified stakeholders by email.

The department manager will then work with the appropriate Shared Services on the execution of communication, to obtain the required approvals for distribution of the finalized communication (Director accountable for communication, Legal, Public Affairs & Communications, etc.).

### 5.3.1 COMMUNICATION CHANNELS

Lessons Learned communications methods may be shared using a variety of communications channels. The most regular communication channels include:

- Leadership email notification (bi-monthly or as required)
- Team meetings (including tailgate talks, safety moments, monthly safety meetings, leadership presentations, etc.)
- Webcasts and Townhalls (may be interdepartmental/cross business unit)
- Safety News
- ELink News

### 5.3.2 SAFETY & RELIABILITY LESSONS LEARNED REPOSITORY ON ELINK (SEARCHABLE ARCHIVE FOR SR LESSONS LEARNED) ALERTS

An alert can be created to communicate lessons learned from a safety, environment or quality event, observation, inspection, audit, verification assessments, etc. Alerts highlight a specific issue discovered internally or externally involving people, equipment, processes, procedures or substances to provide early learnings and prevent further events beyond the immediate work location. An Alert can be used to provide early learnings that can be released as soon as possible.

The template for Alerts is available on ELink. The Integrated Management System (IMS) Program Subject Matter Experts (SMEs) must ensure all of the required information is accurately filled out in the template.

### 5.3.3 HIGH VALUE LEARNING EVENT

A High Value Learning Event (HVLE) is an event in which the lessons learned identified by the event analysis can be applied across the business unit(s), the enterprise and/or relevant external parties (contractors and/or industry). If the event has learnings that are applicable beyond the project, worksite or office location and the event has an actual severity rating of A2+ or an event that has a potential severity of P3+ per the Enterprise Severity Matrix, the People Leader must consider the development on an HVLE. However, an event may be shared no matter the severity ranking if deemed appropriate to do so.

An HVLE communication is developed once the analysis is completed and all root causes and contributory factors have been identified and appropriate corrective actions have been approved.

HVLE templates are provided on [ELink](#). The assigned People Leader (or designate) must ensure all of the required information is accurately filled out in the template before distribution.

### **5.3.4 LESSONS LEARNED TOOLBOX TALK**

The purpose of the Lessons Learned Toolbox Talk is to facilitate a two-way discussion with the team on recent learnings. If there are event learnings that do not warrant development and distribution of an HVLE or Safety Alert, a Toolbox Talk can be developed and reviewed at the daily tailgate or safety meeting. Toolbox talks can be developed using either the Event Related or General Awareness Toolbox Talk templates on ELink. Examples include event trending, identifying weak safety signals, etc.

### **5.3.5 STAND DOWNS**

A stand-down is a designated time for frontline People Leaders and their reports as well as contractors to engage directly with their leadership on the importance of safety and reliability. Leaders reiterate Enbridge's Values, Safety Principles, expectations and frontline accountabilities within the Safety and Reliability Policy and reconfirm everyone's expectations within them. Often stand-downs are triggered by concerning event trends, unsafe behaviors or identification of immediate danger requiring stop work, though they are not limited to these scenarios.

### **5.3.6 VIRTUAL TAILGATE**

A virtual tailgate talk is a webcast that is recorded and posted to ELink along with supporting resources. The audience is People Leaders at the business unit level. This is coordinated by Shared Services and can be used to share lessons learned when required.

### **5.3.7 QUALITY BULLETIN**

A quality bulletin is an internal document issued by the Quality Department that shares lessons learned, corrective action(s) or other pertinent quality related information). Quality Bulletins and the Quality Bulletin Guideline may be found on the [Quality SharePoint site](#).

### **5.3.8 LESSONS LEARNED INFOGRAPHICS**

Human Factors Infographics breakdown an event that was influenced by human factors and where our safety barriers and systems worked or did not work as intended. Infographics are shared across the Enterprise using ELink. A request for an event to be developed into an Infographic can be submitted to Safety Shared Services for consideration.

## 5.4 LEGAL CONSIDERATIONS

Early engagement with the legal department is encouraged as legal approval is required prior to the lessons learned document being released for wider distribution across the enterprise or external to Enbridge. Lessons learned authors must keep the following considerations front and center when diverse audience is the targeted stakeholder group for sharing learnings.

### 5.4.1 NO PERSONAL (OR OTHER IDENTIFYING) INFORMATION OF INDIVIDUALS

- Lessons Learned documents cannot contain personal or other identifying information of individuals involved in an event. This includes names, titles/positions, photographs (unless faces and other identifying features are blurred out), name of the company they work for, age, gender, religion, physical characteristics, etc.
- Lessons Learned should not contain the names of contractors/subcontractors. When referring to a contractor/subcontractor use the term “worker” or “contractor”. Enbridge can be referred to as “Enbridge”.
- If the Lessons Learned is addressing an event that resulted in an injury to an individual, no medical information of the injured person can be disclosed. The general nature of the injury (i.e., broken leg, fractured wrist) can be included.
- Lessons Learned cannot disclose in a statement that a worker failed an A&D test. The Lessons Learned can state a worker was non-compliant with the respective A&D policy.

### 5.4.2 NO COST/ OPERATIONAL IMPACT INFORMATION

- If the Lessons Learned is addressing an event that had cost impacts, damages suffered or operational impacts, the Lessons Learned should not disclose the amount of costs/damages incurred, nor should it disclose any operational impacts such as delays, missed targets, etc.

### 5.4.3 REGULATORY AND INTERNAL EVENT ANALYSES/ REGULATORY AND CIVIL PROCEEDINGS

- If the Lessons Learned is addressing an event under a regulatory analysis, the Law Department must be consulted before it is published or circulated in any manner.
- If the Lessons Learned is addressing an event for which an internal analysis report was prepared under legal privilege, the Law Department must be consulted before it is published or circulated in any manner.
- If the Lessons Learned is addressing an event that has resulted in, or is anticipated

to result in, a civil claim against Enbridge, the Law Department must be consulted before it is published or circulated in any manner.

- Lessons Learned should not contain legal conclusions or statements alleging, speculating or attributing liability to Enbridge or another party. Lessons Learned should not contain subjective/personal opinions about an event.
- Lessons learned are not subject to legal privilege and could enter the public domain or be produced in a regulatory or civil proceeding. As such, careful consideration should go into their preparation.
- Disclaimer to be included at the end of a Lessons Learned form if it will be sent to an external third party (i.e., contractor) as follows:
- “This [insert type of Lessons Learned form] is for general information purposes only. This [insert type of Lessons Learned form] is not a substitute for professional safety advice. Parties relying on the information set out in this [insert type of lessons learned document] do so entirely at their own risk.”

## 6.0 TRAINING REQUIREMENTS

There are no essential training assignments that directly relate to this standard. All training assignments and course descriptions can be viewed in the Safety Training Matrices and Course Syllabi.

## 7.0 Related Documents

CEPA Lessons Learned Framework

Construction Industry Institute Effective Management Practices and Technologies for Lessons Learned Programs (Best Practice)

Controlled Vocabulary

Enterprise Severity Matrix

Event Analysis Standard

Quality Bulletin Guideline

Safety Meetings, Tailgates & Toolbox Talk Standard

## 8.0 STANDARD REVIEW

A subject matter expert (SME) will perform a technical review of this standard every two years to determine the accuracy of the content/information. The SME shall solicit input from applicable stakeholders to ensure the effectiveness of the standard. Any suggested changes must be reviewed and approved by the designated document owner.

## 9.0 REFERENCE

SOR/99-294 - Canadian Energy Regulator Onshore Pipeline Regulations

6.5 (1) (u) Management System Processes

## 10.0 APPENDIX

### 10.1 LESSONS LEARNED PROCESS FLOW

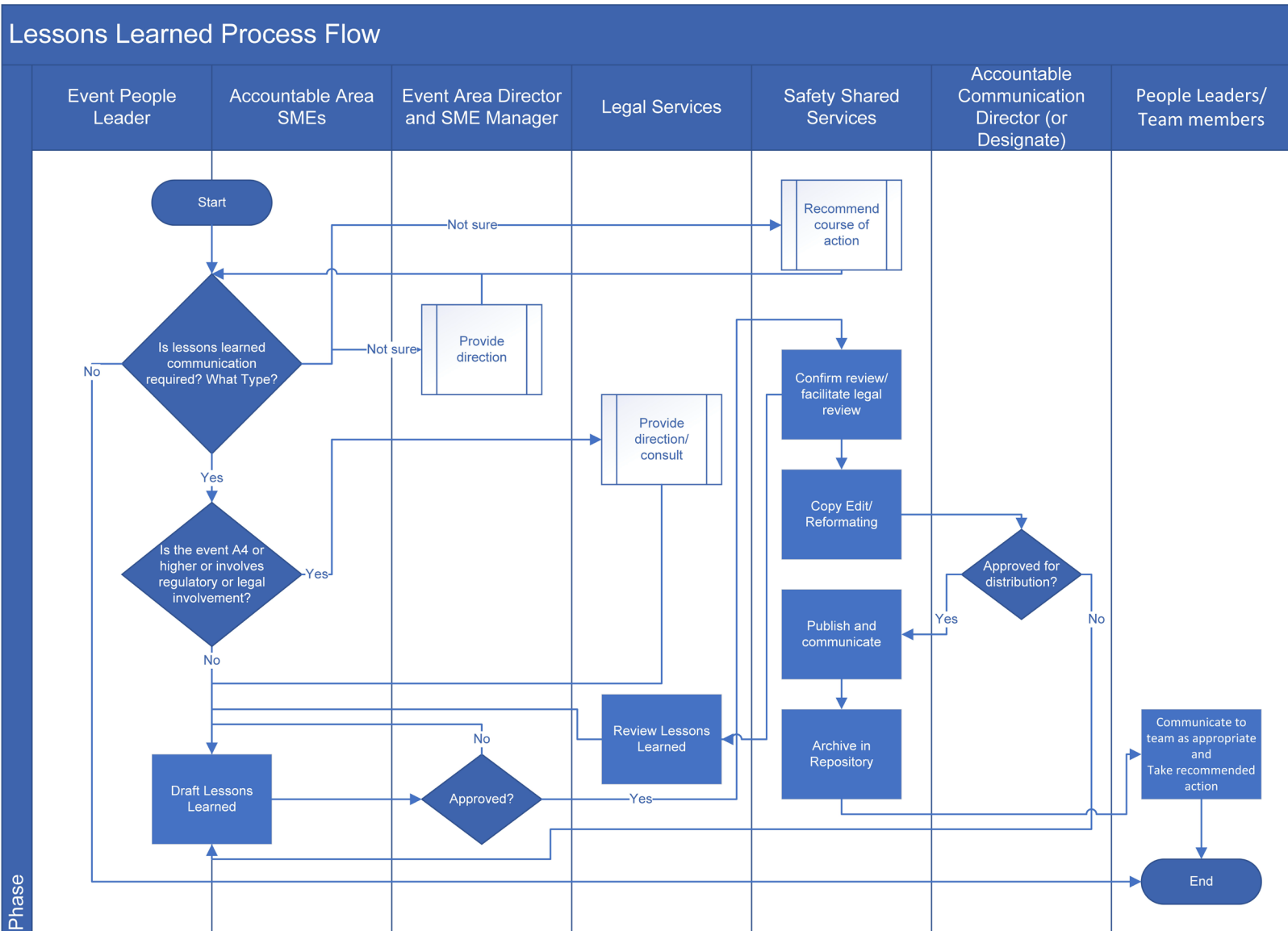



**10.2 PROCESS FLOW DESCRIPTION:**

Process step	Responsible	Description
Determine if Lessons Learned Communication is Required and What Type	Event Analysis Team: Event People Leader and IMS SME	The event analysis team determines if a lessons learned communication is required and determines the type and distribution scope. If unsure, consult with either regional director, SME manager or safety shared services. Note: See lessons learned methods, section 5.3.
Based on Severity: Is the event P4 or higher? Contact legal	Event Analysis Team: Event People Leader and IMS SME	If the event is P4 or higher, contact the legal department before developing any drafts or sharing any communications in case the event is under regulatory restrictions or discoverable in legal proceedings.
Draft Lessons Learned	Event Analysis Team: IMS SME with support of Event People Leader	Event analysis team works together to prepare lessons learned communication with IMS SME taking the lead.
Preliminary Approval Cycle	Regional Director and IMS SME Manager (Optional, send to legal services for review)	Review proposed communication and distribution. Provide feedback and review until satisfactory (optional: send to legal services for feedback during this cycle)
Safety Shared Services and legal review	Safety Shared Services	a) Determine if legal services review is complete, if not, facilitate legal services review. b) Copyedit and reformat for print. c) Prepare email notification
Distribution Approval	Accountable Communication Director or Designate	Review final drafts and email for distribution approval
Publish and archive in repository	Safety Shared Services	Upload Lessons Learned documents to Lessons Learned Repository on ELink and send email to people leaders and subscribers.
Share with team members	People Leaders	Review communicated lessons learned and determine applicability of lessons learned to team. If relevant to team, share the information and take action to prevent similar event.

## CHANGE LOG

Section	Version 4.0	Version 4.1
5.5	<p><b>LEADERSHIP IN ACTION</b></p> <p>Where applicable, the Leadership in Action process is designed to support this critical component of building awareness and institutionalizing lessons learned within the organization. It also provides a framework for People Leaders to engage directly with their reports, to demonstrate leadership and strengthen our safety &amp; reliability culture.</p>	<p>Removed text to align with the retirement of the Safety Leadership In Action program.</p>
Entire document		<p>Clerical corrections including spelling, grammar, and document names.</p> <p>Updated terminology from incident and investigation to event and analysis.</p>

<End of Document>



**ENBRIDGE<sup>®</sup>**  
**Standard**

---

**Material Handling**

---

**Effective Date:** 2022-01-17  
**Version #:** 1.1  
**Version Date:** 2024-03-27

---



This page intentionally left blank



**Document Version Register**

<b>Version Number</b>	<b>Version Date</b>	<b>Approved By</b>	<b>Section Number and Title</b>	<b>Details of Version</b>
1.0	2022-01-17	Jeff Safioles	Entire Document	New Standard
1.1	2024-03-27	Troy Croft	All sections	Clerical corrections



---

This page intentionally left blank



---

## Table of Contents

1.0 Purpose .....	2
2.0 Scope .....	2
3.0 Prerequisites.....	2
4.0 Definitions & Acronyms .....	2
5.0 Roles & Responsibilities.....	3
6.0 Standard-Specific Requirements .....	4
6.1 Loading & Unloading Operations.....	4
6.1.1 Loading Activities .....	5
6.1.2 Unloading Activities .....	6
6.2 Cargo Management.....	7
6.2.1 Load Handling.....	7
6.2.2 Load Securement .....	7
6.2.3 Means of Securement.....	7
6.3 Hazard Assessment .....	9
6.3.1 Pre-Load/Unloading Review Check.....	9
6.3.2 Area Assessment.....	10
6.3.3 Trailer And Load .....	10
6.3.4 Required Plans .....	11
6.3.5 Required Equipment.....	11
7.0 Training.....	11
8.0 Related Documents .....	11
9.0 Standard Review .....	12
10.0 References .....	12
Change Log.....	12

## 1.0 PURPOSE

The purpose of this Standard is to provide the minimum requirements for the safety controls associated with the loading, unloading and transportation of material.

## 2.0 SCOPE

This standard applies to LP Operations and LP Projects.

Contractors and subcontractors shall comply with Enbridge health and safety requirements set out in this standard, as articulated within applicable contractor safety specifications. If a contractor or subcontractor has a health and safety standard or policy materially different from Enbridge's, the contractor/subcontractor shall follow the most stringent requirement. Contractors and subcontractors are still obligated to meet the requirements of all applicable laws related to this standard.

In the event a contractor's or subcontractor's standard exceeds the requirements of this standard, Enbridge may, in its sole discretion, choose to adopt the contractor's or subcontractor's standard for any given contract or work order.

When working with any type of suspended loads, refer to hoisting and rigging standard for the applicable requirements.

## 3.0 PREREQUISITES

Hazard Assessment & Control Standard

## 4.0 DEFINITIONS & ACRONYMS

*Cargo* - all articles or material carried by a vehicle, including those items carried inside the vehicle

*Control Zone* – the work area where the unloading and loading activities are being performed and have been demarcated and/or monitored by personnel to prevent unauthorized entry into the area.

*FLHA* – Field Level Hazard Assessment

*JHA* – Job Hazard Assessment

*Lift*—to hoist, lower, and horizontally move a suspended load.

*Load Handling Equipment (LHE)* – equipment used to move a load

*Load Securement* – immobilizing a load from movement by using load securement equipment such as blocks, braces, or straps.

*Loading/Unloading Operation* – includes all types of general freight / cargo loads that require LHE to move load.



*Qualified* - one who, by possession of a recognized degree, certificate, or professional standing, or who by knowledge, training and experience, has successfully demonstrated their ability to solve or resolve problems relating to the subject matter, the work, or the project.

*Securing device* – any device specifically manufactured to attach or secure cargo to a vehicle or trailer. (e.g. wire rope, steel strapping, clamps and latches, grab hooks, shackles)

*Working Load Limit (WLL)* – the maximum working load specified by the manufacturer

## **5.0 ROLES & RESPONSIBILITIES**

People Leaders shall:

- Ensure that employees, contractors, and subcontractors under their control are aware of and comply with this standard.
- Ensure workers are appropriately trained to effectively implement this standard.
- Not knowingly permit, require, or authorize the unsafe loading, unloading, or transporting of cargo by employees, contractors, and/or subcontractors.
- Require focused inspections to ensure compliance with this standard.

Workers involved in loading and unloading activities shall:

- Be qualified in the operation of LHE used to perform loading duties.
- Be qualified in the handling and securement of cargo for transportation.
- Assess the load and whether cargo/freight to be loaded/unloaded for transport requires additional mitigations.
- Ensure safe site set up before commencing loading/unloading activities. When securing the load, ensure the appropriate securement device is used and is in safe working order. Ensure the securement device has been tightened to a proper tension and avoiding overtightening.

Signalers/Spotters shall:

- Use standard hand signals or agreed upon hand signals.
- Maintain proper body positioning, keeping body out of the line of fire and avoid walking backwards whenever possible.
- Maintain line-of-sight with the equipment operator.
- Utilize tag lines when appropriate.

Vehicle and LHE Operators shall:

- Ensure a pre-trip/pre-use inspection is completed prior to use of any LHE.

- Ensure that all material or cargo is adequately secured prior to moving the vehicle/equipment. Perform checks during rest stops if applicable.
- Remove all excess dirt or debris from the trailer or vehicle that may pose a hazard during transport. No objects should fall from the trailer, as per regulations.
- Obey all traffic laws and ensure all the applicable permits are in place.
- Notify their Supervisor of any issues or concerns regarding material, equipment, travel, etc.
- Not remove load securement devices until Enbridge or authorized representative has completed the appropriate hazard assessments at the unloading location. Ensure proper securement of the load prior to moving the vehicle/trailer/LHE.
- Ensure all loads are transported in accordance with applicable regulatory requirements.

Safety Team shall:

- Ensure that the work practices within this Standard meet or exceed the legislative requirements per the jurisdiction the work is being completed in.
- Provide timely advice, support, and assistance regarding implementation of this Standard.
- Conduct periodic assessments of the overall effectiveness of implementation of the standard.

Safety Shared Services shall:

- Be responsible for the maintenance and continuous improvement of this Standard.

## **6.0 STANDARD-SPECIFIC REQUIREMENTS**

### **6.1 LOADING & UNLOADING OPERATIONS**

Where the load has mixed materials, a sequential loading and unloading plan (safe work procedure, JHA, or lift plan for the planned task) is required for loading and unloading the different types of materials. The sequential plan must include how the stored energy of the load will be managed throughout the loading and unloading processes.

Before loading a trailer, refer to the Vehicle Operation Standard for the safe operation of trailers.

Safety controls include the following:

- Control zones are defined using hard/soft barricading or the use of a control zone signaler/spotter person to prevent unauthorized entry during operations.
  - Anyone not directly involved in the operation must not enter these control zones unless the LHE operator has signaled that it is safe to enter, and the equipment operation has ceased all movement.

- The vehicle driver is to remain outside the control zone in a designated location during the operation unless otherwise instructed by the LHE operator.
- Operators will immediately stop work if the location of the driver cannot be confirmed, or any pedestrian or vehicle enters the control zone without permission.
- While loading or unloading on an incline, or if there is a potential for unintentional movement, vehicles and trailers shall be secured by a secondary means (e.g., wheel chocks), in addition to the vehicle's braking system.
- A signaler/spotter shall be used when:
  - Parts of the work area could potentially be obscured,
  - LHE is backing up or moving, and the operator cannot see all parts of the equipment/load and its path of travel,
  - LHE is backing up or moving in congested areas,
  - LHE makes turns with restrictive side clearances,
  - Equipment or parts of equipment may reach the safe limits of approach (e.g. near overhead power lines), or
  - Movement of equipment may result in the operator and/or other workers being exposed to additional hazards

Prior to performing any loading or unloading activities:

- Assess and determine if activity would be classified as a lift under the Hoisting and Rigging Standard. If so, further determine lift classification (i.e., standard, serious, or critical lift).
- Ensure trucks and trailers are on a stable, level surface.
- LHE (e.g., forklift, trailer) and securement devices have been visually inspected and are of suitable capacity and size for the load dimensions and weight.

For all serious or critical lifts, follow the lift requirements in the Hoisting and Rigging Standard.

For lifts that are not classified as being serious or critical, details around the lift shall be documented on a hazard assessment (JHA and/or FLHA) and discussed with workers involved in the lift. The details documented should include records of weight, radius, and percentage of load chart for each lift, or for a series of lifts from a single location use the details from the heaviest load.

### **6.1.1 LOADING ACTIVITIES**

The following requirements apply when performing loading activities:

- Vehicles/trailers shall be loaded on a stable, level surface. Note: If a level surface cannot be controlled, see section 6.3.2 (Area Assessment) in this standard.
- Ensure the load weight does not exceed the rated capacity of weight of the vehicle/trailer and is properly distributed.
- LHE operators shall ensure that their equipment and/or trailer is inspected and of suitable capacity and size (e.g., fork length) for the load dimensions.
- Communicate to the personnel loading the equipment/trailer to ensure signals and plans are understood by all parties involved.
- Persons performing rigging must be qualified and perform in accordance with the rigging standard and ensure that all rigging is inspected, all rigging is rated for the load, all connections securely fastened, and the load is rigged as per its center of gravity to ensure a level lifting operation.
- Ensure the load is secured prior to travel commencing.

Once the cargo is loaded onto the vehicle/trailer, it is the responsibility of the driver to ensure proper securement of the load prior to moving the vehicle/trailer and ensure all loads entering public highways comply with all regulatory requirements.

### **6.1.2 UNLOADING ACTIVITIES**

The following requirements must be applied when performing unloading activities:

- Ensure all personnel, obstructions and other hazards are clear of the path of travel.
- Verify personal protective equipment.
- Communicate to the personnel unloading the equipment/trailer to ensure signals and plans are understood by all parties involved.
- Ensure equipment is securely parked and on a level surface prior to unloading.
- Set up a control zone to prevent unauthorized access into the load movement location and utilize ground personnel if required.
- Utilize a spotter. Ensure visual contact is always maintained between the spotter and equipment operator and stop if visual contact is compromised.
- Trailers must be free of excess dirt and debris prior to travelling on roadways.
- Ensure the deck is swept prior to departure.

Note: If there are issues or concerns with unloading the material, the work conditions are unsafe, equipment has failed, etc. contact your supervisor immediately for further direction.

## **6.2 CARGO MANAGEMENT**

Cargo transported by a vehicle shall be contained, immobilized, or secured so that it cannot:

- leak, spill, blow off, fall from, fall through, or otherwise be dislodged from the vehicle, or
- shift upon or within the vehicle to such an extent that the vehicle's stability or maneuverability is adversely affected, or the cargo cannot be safely unloaded.

### **6.2.1 LOAD HANDLING**

When using LHE with forks, ensure:

- the length of the material being moved does not exceed the length of the forks,
- all material on a pallet is secured to the pallet prior to moving it,
- the forks are positioned as low as possible when travelling,
- the load is stable or strapped in place, and
- the load is centered with the heaviest part located near the mast.

The weight of material being used shall not overload the equipment moving the materials.

### **6.2.2 LOAD SECUREMENT**

Potential hazards when securing a load include pinch points, crush points, caught in, caught under or between, collapsing material, and stored energy.

All loads must be secured prior to transporting. If rigging is used, ensure that tension is maintained on the rigging and the rigging is not unhooked until the load is fully secured.

A securing device, integral locking device, movable structure, or blocking device used to secure cargo to a vehicle shall be secured in a manner that prevents it from becoming unfastened while the vehicle is in motion.

The components of the cargo securement system of a vehicle shall be:

- in proper working order,
- fit for the purpose for which they are used, and
- have no knots, kinks, cuts, cracks, damaged or weakened components that will adversely affect their performance of securement purposes.

### **6.2.3 MEANS OF SECUREMENT**

When securing a load, the weight of the load must be known to ensure appropriate means of securement is used. Perform a visual inspection of all load securement devices before use, to ensure they are rated for the load.

- Cargo must be secured so that it cannot shift, tip, leak, spill, blow off, fall from, fall through, or otherwise be dislodged from the vehicle. Round objects must be secured and supported to prevent movement.
- The total working load limit of any cargo securement system must follow applicable federal, state, and local laws and regulations.
- The total working load limit of any cargo securement system must be at least half of the weight of the load being secured.

All cargo must be secured on or in a vehicle. This can be accomplished by using the methods and tools listed below, including but not limited to:

- Tiedowns/straps/chains, blocking, bracing, friction mats, pipe stakes, or a combination of these;

**Tiedowns/Straps/Chains:**

- Each tiedown must be secured so that it does not come loose, unfastened, opened, or released while the vehicle is moving.
- All tiedowns and other parts of a cargo securement system must be located inside any rub rails whenever practical.
- Edge protection must also be used whenever a tie down would be subject to wear or cutting at the point where it touches an article of cargo.
- Tiedowns must be marked by the manufacturer with respect to their working load limit.
- Tiedowns and other securement devices must be strong enough to properly secure a load.

**Blocking/Bracing:**

- The material used for blocking or bracing, such as chocks and cradles, must be strong enough to withstand being split or crushed by the cargo or tiedowns.
- Chocks, wedges, a cradle, or other equivalent means that prevent rolling, tipping or shifting must not become unfastened or loose while the vehicle is in transit.

**Use of Load Binders**

When securing loads with load binders, workers shall:

- Use the load binders properly, to avoid serious injury. Lever type load binders can store energy and have the potential to “kickback” towards body, hands, or equipment.
- Ensure the load binder has the applicable load rating for the task and weight, and that all ratings are legible. Never use cheater pipes (snipes) or handle extenders to tighten or release a load.

- Hook the load binders so they can be operated while standing on the ground. Do not operate a load binder while standing on the load.
- Position the load binder so the handle can be pulled downward to tighten the chain.
- Position themselves out of the path of the moving handle and any loose chain.
- Keep hands out of pinch point, by releasing the handle with an open hand under the handle by pushing upward (never close your hand around the handle).
- A ratchet-type binder shall be used if sufficient leverage cannot be obtained using the lever-type load binder by itself.
- Visually inspect the chain binders before each use for:
  - excessive wear
  - twisted or distorted links
  - excessive stretch
- Visually inspect web binders before each use for webbing and ratchet damage.
- Remove load binders from service and replace if damaged or weakened.

### **6.3 HAZARD ASSESSMENT**

The following sections outline various items to consider when completing a hazard assessment for material handling activities and tasks.

#### **6.3.1 PRE-LOAD/UNLOADING REVIEW CHECK**

- Is there a current safe work procedure, JHA, or lift plan for the planned task?
- Was the work area inspected for overhead hazards?
- Is the truck / trailer brakes set, and parked on level solid ground?
- Was a work area walk-through conducted, area hazards identified, and mitigation plans established?
- Have bunks, dunnage, securement devices (e.g., strapping, tie-downs, chains, binders, blocking, bracing, edge protection, wedges) been inspected for damage or excessive wear?
- Are the available personnel trained for the work?
- Has a dedicated signaler/spotter person been identified?
- Was the inspection of rigging and hoisting / lifting equipment performed?

- Is the lifting / hoisting equipment within its lifting capacity (e.g., forklifts / cranes / telehandlers)?
- Is the control zone demarcated with appropriate barricading, signage, or by the use of signaler/spotter person?
- Unloading: Was the load inspected and confirmed that no “stored energy hazards” were identified prior to removing securement devices? E.g., straps under tension, load movement or free-standing items.
- Does the load require a sequential plan for loading or unloading? (Required for loads of mixed materials).
- Will any load components need to be secured (rigged) prior to removing transport strapping to prevent uncontrolled movement?
- Will the load need to be re-secured after it has been loaded or unloaded?

### **6.3.2 AREA ASSESSMENT**

- Hazardous weather conditions (e.g., cold, heat, wind, rain)
- Unstable ground (e.g., mud, sand)
- Site access / egress
- Uneven terrain (e.g., slopes, debris)
- Congestion (e.g., other workers, other work activities)
- Vehicle traffic / public roads (e.g., 3<sup>rd</sup> party vehicles, construction traffic)

### **6.3.3 TRAILER AND LOAD**

- Fall potential
- Chain / binder hazards
- Straps under tension
- Uncontrolled movement
- Pinch / crush point
- Improper load configuration
- Unknown weight
- Unknown center of gravity



---

### **6.3.4 REQUIRED PLANS**

- Lift plan - serious or critical lift
- Fall - working at height
- Electrical - safe limits of approach

### **6.3.5 REQUIRED EQUIPMENT**

- Crane / excavator (consider capacity)
- Forklift / telehandler (consider fork length and size, and capacity)
- Skidsteer

## **7.0 TRAINING**

Personnel involved in the movement of material must be knowledgeable in this Standard and may be assigned applicable training as identified by the Safety Training Matrix.

Reference the Health & Safety training syllabi and matrices for further information and training re-certification requirements.

## **8.0 RELATED DOCUMENTS**

Personal Protective Equipment Standard

Commercial Motor Vehicle Standard – US

Commercial Motor Vehicle Standard - CAN

Environmental Conditions Standard

Field Ergonomics Standard

Focused inspection

Hoisting and Rigging Standard

LHE inspection

Powered Mobile Equipment Standard

Sequential loading/unloading plan

Standard lift details (JHA)

Vehicle Operation Standard

Walking-Working Surfaces & General Housekeeping Standard

## 9.0 STANDARD REVIEW

A subject matter expert (SME) will perform a technical review of this standard every two years to determine the accuracy of the content/information. The SME shall solicit input from applicable stakeholders to ensure the effectiveness of the standard. Any suggested changes must be reviewed and approved by the designated document owner.

## 10.0 REFERENCES

### United States

Code of Federal Regulations (CFR), Title 49 Transportation

- Part 383 – Commercial Driver’s License Standards; Requirements and Penalties
- Part 390 – General Federal Motor Carrier Safety Regulations
- Part 392 – Driving of Commercial Motor Vehicles
- Part 397 – Transportation of Hazardous Materials; Driving and Parking Rules
- FMCSA Driver’s Handbook on Cargo Securement

### Canada

Canadian Occupational Health and Safety Regulations: Part XIV Materials Handling

National Safety Code, Standard 10 – Cargo Securement

## CHANGE LOG

Sections	Version 1.0	Version 1.1
Entire document		Clerical corrections including spelling, grammar, and document names

<End of Document>



---

# Standard

---

## Personal Protective Equipment

---

**Effective Date:** 2019-03-30  
**Version #:** 2.3  
**Version Date:** 2024-03-27

---



This page intentionally left blank



**Document Version Register**

<b>Version Number</b>	<b>Version Date</b>	<b>Approved By</b>	<b>Section Number and Title</b>	<b>Details of Version</b>
1.0	2019-03-30	Sean Evans	Whole Document (New Standard)	This is the new H&S standard that was developed as part of the LP   MP Safety Manual Transition Project
1.1	2020-06-01	Sean Evans	2.0	Alignment with Contractor Safety Specifications
1.2	2020-06-01	Murray Evenson	Cover page update	Cover page update
1.3	2021-12-01	Murray Evenson	9.0	Updated section 9 to reflect the appropriate review process
2.0	2022-05-31	Murray Evenson	6.1.2, 6.1.6, 6.1.7.3	Clarification to current content and layout, updated HVIS requirements for speeds (CAN) and added a new high temperature exception process
2.1	2022-10-21	Murray Evenson	6.1.7.2	Updated PFD Distance requirements as a post task to align to the new Working on Ice or Near Water section 6.11 in the Environmental Conditions standard
2.2	2023-04-18	Murray Evenson	6.1.6	Reworded section so the requirements were clearer
2.3	2024-03-27	Troy Croft	All sections	Clerical corrections



This page intentionally left blank

---

## Table of Contents

1.0	Purpose .....	2
2.0	Scope .....	2
3.0	Prerequisites.....	2
4.0	Definitions & Acronyms .....	2
5.0	Roles & Responsibilities.....	3
6.0	Standard-Specific Requirements .....	3
6.1	Personal Protective Equipment .....	3
6.1.1	Head Protection .....	3
6.1.2	Eye Protection .....	4
6.1.3	Hearing Protection .....	4
6.1.4	Hand Protection .....	4
6.1.5	Foot Protection .....	5
6.1.6	High-Visibility Safety Apparel .....	5
6.1.7	Enbridge Worksite Clothing Requirements.....	7
7.0	Training Requirements .....	8
8.0	Related Documents .....	9
9.0	Standard Review .....	9
10.0	References .....	9
11.0	Appendix.....	10
11.1	Appendix A .....	10
	Change Log.....	11

---

## 1.0 PURPOSE

The purpose of this standard is to ensure Enbridge workforce and contractors are safe by setting the minimum requirements for Personal Protective Equipment (PPE) while working on Enbridge worksites.

## 2.0 SCOPE

This standard applies to LP Operations and Projects being completed for LP.

Contractors and subcontractors shall comply with Enbridge health and safety requirements set out in this standard, as articulated within applicable contractor safety specifications. If a contractor or subcontractor has a health and safety standard or policy materially different from Enbridge's, the contractor/subcontractor shall follow the most stringent requirement. Contractors and subcontractors are still obligated to meet the requirements of all applicable laws related to this standard.

In the event a contractor's or subcontractor's standard exceeds the requirements of this standard, Enbridge may, in its sole discretion, choose to adopt the contractor's or subcontractor's standard for any given contract or work order.

## 3.0 PREREQUISITES

Hazard Assessment and Control Standard

Safety Orientation and Visitor Access Standard

## 4.0 DEFINITIONS & ACRONYMS

*ANSI*—American National Standards Institute

*ASTM*—American Standard for Testing and Materials

*CSA*—Canadian Standards Association

*Enbridge worksite*—Entire work area required for the work, including station property, right-of-way, temporary working space, and all right-of-way storage areas as required by Enbridge. It does not include administrative offices, control rooms, lunchrooms or change rooms.

*FR*—Flame Resistant

*GDL*—Governance Documents Library

*HVSA*—High Visibility Safety Apparel

*ICS*—Incident Command System

*NFPA*—National Fire Protection Agency

*PPE*—Personal Protective Equipment

*ROW* – Right Of Way



---

## **5.0 ROLES & RESPONSIBILITIES**

Safety Team shall:

- identify appropriate PPE for employees; and
- assist with the interpretation of the Standard.

People Leaders shall:

- provide workers with appropriate PPE;
- ensure workers are trained on the use, maintenance, and limitations of the PPE;
- confirm that workers are wearing the required and approved PPE;
- ensure that the maintenance and inspection of PPE is completed; and
- wear appropriate PPE when required.

Workers shall:

- use all required PPE;
- maintain, store and inspect PPE in accordance with manufacturer's specifications; and
- dispose of and replace any defective/damaged PPE.

Safety Shared Services shall:

be responsible for the maintenance and continuous improvement of the standard.

## **6.0 STANDARD-SPECIFIC REQUIREMENTS**

### **6.1 PERSONAL PROTECTIVE EQUIPMENT**

Enbridge has minimum requirements for PPE listed in this standard. Additional PPE or protective apparel may be required depending on the specific site requirements, hazards or work activities.

#### **6.1.1 HEAD PROTECTION**

At a minimum, *Class E* approved industrial head protection (hard hats) shall be worn at all times on Enbridge worksites except when:

- sheltered in a vehicle or equipment with an enclosed cab;
- actively engaged in welding where overhead hazards have been eliminated;
- getting in or out of helicopters or when working near helicopters under full throttle (unless the helicopter is involved in slinging operations); and/or
- working in, on or near open water as determined by an incident commander when under the Incident Command System (ICS).

Workers shall:

- clean a hard hat with suitable cleaning products that do not affect the integrity of the hard hat (i.e., do not use solvents);
- only wear liners made for wearing under hard hats;
  - liners must be FR rated when working in areas requiring FR (see Section 6.1.7.3); and/or
- store hardhats away from heat sources.

Workers shall not:

- wear Cowboy style hardhats; and/or
- apply products to the hard hat that may degrade or weaken the hard hat shell or component materials (e.g., do not apply insect repellent).

### **6.1.2 EYE PROTECTION**

Safety glasses are essential to reducing the risk of eye injuries on the worksite. Enbridge requires all workers to wear ANSI Z87.1 or CSA Z94.3 approved safety glasses (prescription and non-prescription) and impact resistant side shields at all times when working on Enbridge worksites.

Safety glasses are not required:

- in a vehicle or equipment with an enclosed cab;

If a worker is using safety glasses or prescription safety glasses at a work location where fogging of the eyewear is a hazard, anti-fog eyewear or anti-fogging solution shall be made available and used by the worker as required.

See Appendix A, Table 1 and 2 for minimum marking requirements.

### **6.1.3 HEARING PROTECTION**

Workers who are exposed to noise at 85 dBA or above shall wear hearing protection.

Hearing protection shall be worn as follows:

- when in work areas where hearing protection signage is posted;
- when operating or working around any piece of equipment where the noise level is greater than (>) 85 dBA;
- when exposed to noise levels greater than or equal to ( $\geq$ ) 105 dBA, workers shall wear both ear plugs and earmuffs; and
- when an arc flash hazard exists and hearing protection is required, workers shall wear ear canal inserts (i.e., ear plugs).

### **6.1.4 HAND PROTECTION**

Hand protection shall be worn at all times on Enbridge worksites. Hand protection shall:

- be appropriate to the task being performed;
- provide suitable hand protection against any known or foreseeable hazards related to the task; and
- allow the wearer to effectively complete the task while using them.

If gloves cannot be worn because it creates an additional hazard within the execution of the task, it needs to be documented on the Field Level Hazard Assessment along with any additional mitigative actions taken to reduce the potential for a hand injury.

### **6.1.5 FOOT PROTECTION**

CSA 1 or ASTM F2413-11 I/75 C/75 approved protective footwear shall be worn at all times on Enbridge worksites.

Protective footwear shall:

- have a minimum height of 15 cm (6 in) ankle support, when measured from the heel to the top of the boot,
- have slip-resistant sole, and
- provide sufficient protection against injury to the feet and ankles as appropriate for the work environment and assessed hazards.

Workers and visitors may be exempt from the requirement for protective footwear only if:

- they are on a supervised or controlled tour of a site or facility, or
- if they are visiting a site or facility for administrative reasons only, and while there, are not exposed to hazards that would require the foot protection set out in this standard.

Protective footwear shall have markings as required, as shown in the Appendix A, Table 3, by jurisdiction.

### **6.1.6 HIGH-VISIBILITY SAFETY APPAREL**

High-Visibility Safety Apparel (HVSA) shall be worn by workers when required by a hazard assessment, worksite requirements and/or regulatory requirements.

This section provides three examples of when HVSA shall be worn:

- Traffic hazards or task specific PPE
- When Class 3 high visibility apparel is required
- When high visibility flame resistant (FR) apparel is required.

---

### **Traffic Hazards or Task Specific PPE**

All workers must wear at minimum Class 2 high visibility safety apparel (ANSI 107 or CSA Z96 approved) on Enbridge worksites when:

- working as a designated signaler/spotter;
- working on or next to roadways with traffic
  - Canada - traffic speeds up to 80km/hr. (50 mph)
- working around powered mobile equipment e.g. elevated work platforms, tracked equipment, excavation equipment for lifting, sidebooms, boom/picker trucks, ditching machines, cranes;
- when managing suspended loads;
- operating ATVs and snowmobiles;
- working in low light or inclement weather conditions; and
- determined by the hazard assessment.

HVSA shall include high visibility headwear (i.e., reflective marking) to increase a worker's visibility in situations where part or all of the worker's body could be obscured, e.g., due to trees, traffic barriers, objects, vehicles or construction materials.

Class 1 HVSA does not provide adequate protection—and should not be used at Enbridge LP locations.

### **When Class 3 High Visibility Apparel is Required**

Class 3 HVSA shall be worn:

- when working on or next to roadways with traffic.
  - Canada – traffic speeds above 80 km/hr (CSA Standard)
- by traffic control personnel; and
- as determined by the hazard assessment.

### **When High Visibility Flame Resistant (FR) Apparel is Required**

When high visibility apparel has been identified as a control by the hazard assessment (e.g., it is a mitigation with hazards associated with mobile equipment) in areas that require FR rated apparel, the high visibility apparel must meet the conditions in section 6.1.7.3 (Flame Resistant Garment Requirements).

### **Exceptions Due to Working in High Temperatures**

If the hazard assessment determines the risk of heat stress hazards (e.g., working over 8 hours in 90°F (32°C) without other mitigations, such as cooling misters, air condition, cooling tents etc.), a people leader can approve the removal of high visibility apparel (with the exception of highway work).

## **6.1.7 ENBRIDGE WORKSITE CLOTHING REQUIREMENTS**

### **6.1.7.1 General Clothing Requirements**

Enbridge requires all workers to always wear full-length pants and long-sleeved shirts on worksites.

On mainline construction, a minimum requirement of six-inch sleeves is acceptable on green field sites or during new mainline construction unless the hazard assessment identifies the need for long sleeve shirts.

### **6.1.7.2 Life Jacket Requirements**

Approved life jackets shall be worn when working within 2 m (6 ft.) of open water (where there is a possibility of drowning).

The type of life jacket used shall be based on the hazard assessment and United States Coast Guard or Transport Canada requirements as applicable.

### **6.1.7.3 Flame Resistant (FR) Garment Requirements**

Workers shall wear FR garments and maintain them in accordance with the manufacturer's specifications (NFPA 2112 and CAN/CGSB 155.20).

Workers shall wear FR garments for daily work when:

- inside fenced or operating facilities,
- within 30 m (100 ft.) of an open system,
- within 30m (100ft.) of ground disturbance/excavation that contains an operating pipeline, and/or
- within any area where exists a potential for flash fires or short duration flame exposures identified on the hazard assessment.

Exceptions to the FR Requirements are in low-risk areas including:

- areas on the ROW identified by the people leader,
- controlled vehicle or escorted tours where risks are eliminated by an Enbridge representative, and/or
- administrative buildings and parking lots.

For this document, the outer layer for FR garments consists of shirt, pants, coveralls, or jacket.

The outer layer of FR garments provided by Enbridge for Enbridge employees shall be a minimum arc thermal protection value (ATPV) of 8 cal/cm<sup>2</sup> and arc flash PPE Category 2. Electrical workers may require an increased level of protection as required by the arc flash hazards label.

FR rainwear worn for protection to flash fires should be compliant to ASTM F2733 and shall state so on the interior label of the garment. FR rainwear worn for arc flash protection should be compliant to ASTM F1891 and shall state so on the interior label of the garment.

If FR garments do not provide sufficient protection from identified hazards, then additional PPE shall be determined (i.e., exposure to steam, longer heat transfer).

FR garments shall:

- be worn with collars closed, and sleeves and cuffs worn down and secured;
- be kept reasonably free from hydrocarbon products like grease and oil;
- be cleaned frequently enough to prevent build-up of contaminants that reduce flame resistance;
- be worn as the outer garment and shall fully cover any non-FR garments worn when FR garments are required;
- not have insect repellents containing DEET applied or sprayed directly on FR Garments as it will negatively impact the flame resistance of the garments;
- be stored in accordance with manufacturer's instructions;
- be removed from service when damaged;
- be inspected prior to use considering the following criteria:
  - fabric damage;
  - damage to threads or seams including skipped, broken or missing stitches;
  - damage to and functionality of all hardware such as zippers, buttons, snaps and other fasteners.

Workers shall wear clothing made with a natural fiber (e.g., cotton, wool) or approved FR undergarments below FR outerwear.

If other safety hazards or concerns (e.g., exposure to asbestos, corrosive materials) exceed the fire hazard, then non-flame-resistant outerwear may be worn over approved FR clothing.

## **7.0 TRAINING REQUIREMENTS**

Personnel working in the field must be knowledgeable in this Standard and may be assigned applicable training as driven by the Safety Training Matrix.

Reference the Health & Safety training syllabi and matrices for further information and training re-certification requirements.

---

## 8.0 RELATED DOCUMENTS

Flame Resistant Garment Requirements and Specification

Industrial Hygiene Standard

Respiratory Protective Equipment Standard

Tools and Equipment Standard

## 9.0 STANDARD REVIEW

A subject matter expert (SME) will perform a technical review of this standard every two years to determine the accuracy of the content/information. The SME shall solicit input from applicable stakeholders to ensure the effectiveness of the standard. Any suggested changes must be reviewed and approved by the designated document owner.

## 10.0 REFERENCES

*Canada:*

Canada Labour Code Part II: Occupational Health and Safety; Section 124—Duties of Employers and Section 126—Duties of Employees

Canadian Occupational Health and Safety Regulations: • Part XII—Protection Equipment and Other Preventive Measures

*United States:*

Code of Federal Regulations (CFR) 1910.269(l)(8)

Part 1910 Subpart I – Personal Protective Equipment

Part 1910.335 – Safeguards for personnel protection

*Standards:*

Canadian General Standards Board (CGSB)

CAN/CGSB 155.20 – Workwear for Protection Against Hydrocarbon Flash Fire

CAN/CGSB 155.21- Provision and Use of Workwear for Protection Against Hydrocarbon Flash fire

CSA Z462-08 – Workplace Electrical Safety

NFPA 2112 - Flame-Resistant Clothing for Protection of Industrial Personnel Against Short-Duration Thermal Exposures from Fire

NFPA 70E - Standard for Electrical Safety in the Workplace

NFPA 2113 - Selection, Care, Use, and Maintenance of Flame-Resistant Garments

ASTM F1506-08- Standard Performance Specification for Flame Resistant Textile Materials for Wearing Apparel for Use by Electrical Workers Exposed to Momentary Electric Arc and Related Thermal Hazards

ASTM F1959 - Standard Test Method for Determining the Arc Rating of Materials for Clothing

ASTM F2733 - Standard Specification for Flame Resistant Rainwear for Protection Against Flame Hazards

ASTM F1891 - Standard Specification for Arc and Flame Resistant Rainwear

ASTM F1449 - Standard Guide for Industrial Laundering of Flame Resistant or Arc Rated Clothing

## 11.0 APPENDIX

### 11.1 APPENDIX A

**Table 1 ANSI/ISEA Z87.1 Minimum Eye Protection Marking Requirements**

Spectacle Lenses	Other Lenses	Frame/ Temple/ Headgear
Shall have: <ul style="list-style-type: none"> <li>▪ Manufacturer's Mark or Logo</li> <li>▪ "+" if Impact Rated</li> </ul>	Shall have: <ul style="list-style-type: none"> <li>▪ Manufacturer's Mark or Logo</li> <li>▪ "Z87"</li> <li>▪ "+" if Impact Rated</li> </ul>	Shall have: <ul style="list-style-type: none"> <li>▪ Manufacturer's Mark or Logo</li> <li>▪ "Z87" Plano or "Z87-2" Rx</li> <li>▪ "+" if Impact Rated</li> </ul>

**Table 2 CSA Z94.3 Minimum Eye Protection Marking Requirements**

Lenses	Frame/ Temple/ Headgear
Shall have: <ul style="list-style-type: none"> <li>▪ Manufacturer's Mark or Logo</li> </ul>	Shall have: <ul style="list-style-type: none"> <li>▪ Manufacturer's Mark or Logo</li> <li>▪ "CSA Z94.3"</li> </ul>

**Table 3 Protective Footwear Markings**

	Canada	USA
General hazards	CSA 1 (Green Triangle)	ANSI Class 75
Electrical work or entering substations	Omega symbol ( $\Omega$ )	Electrical Hazard (EH)
Chainsaw work	White label with green fir tree symbol	---





---

## CHANGE LOG

Section	Version 2.2	Version 2.3
Entire Standard		Clerical corrections including spelling, grammar, and document names.

<End of Document>



---

# Standard

---

## Powered Mobile Equipment

---

**Effective Date:** 2019-03-30

**Version #:** 1.4

**Version Date:** 2024-03-27

---



---

This page intentionally left blank

---



**Document Version Register**

<b>Version Number</b>	<b>Version Date</b>	<b>Approved By</b>	<b>Section Number and Title</b>	<b>Details of Version</b>
1.0	2019-03-30	Sean Evans	Whole Document (New Standard)	This is the new H&S standard that was developed as part of the LP   MP Safety Manual Transition Project
1.1	2019-10-31	Sean Evans	4.0	See Change Log
1.2	2020-06-01	Sean Evans	2.0	Alignment with Contractor Safety Specifications
1.3	2021-12-01	Murray Evenson	9.0	Updated section 9 to reflect the appropriate review process
1.4	2023-03-27	Troy Croft	All sections	Clerical corrections

Uncontrolled Copy if Printed or Downloaded



This page intentionally left blank

---

## Table of Contents

1.0	Purpose .....	2
2.0	Scope .....	2
3.0	Prerequisite .....	2
4.0	Definitions & Acronyms .....	2
5.0	Roles & Responsibilities .....	3
6.0	Standard – Specific Requirements .....	4
6.1	Powered Mobile Equipment .....	4
6.1.1	Safe Operating Requirements for Powered Mobile Equipment .....	4
6.1.2	Elevated Work Platforms .....	6
6.1.3	Tracked Equipment .....	7
6.1.4	Excavation Equipment for Lifting .....	7
6.1.5	Side Booms .....	8
6.1.6	Boom/ Picker Trucks .....	9
6.1.7	Ditching Machines .....	9
6.1.8	Cranes .....	9
6.2	Equipment Inspection .....	11
6.3	Signalers and Spotters .....	12
7.0	Training Requirements .....	13
8.0	Related Documents .....	13
9.0	Standard Review .....	14
10.0	Reference .....	14
	Change Log .....	14

## **1.0 PURPOSE**

The purpose of this standard is to ensure that Enbridge workforce and contractors are safe when working with powered mobile equipment at Enbridge locations.

## **2.0 SCOPE**

This standard applies to LP Operations and Projects being completed for LP.

Contractors and subcontractors shall comply with Enbridge health and safety requirements set out in this standard, as articulated within applicable contractor safety specifications. If a contractor or subcontractor has a health and safety standard or policy materially different from Enbridge's, the contractor/subcontractor shall follow the most stringent requirement. Contractors and subcontractors are still obligated to meet the requirements of all applicable laws related to this standard.

In the event a contractor's or subcontractor's standard exceeds the requirements of this standard, Enbridge may, in its sole discretion, choose to adopt the contractor's or subcontractor's standard for any given contract or work order.

## **3.0 PREREQUISITE**

Driver's License and Driving Record Policy

Safe Communication While Driving Policy

## **4.0 DEFINITIONS & ACRONYMS**

*EWP*—Elevated Work Platform

*Heavy Service*—Service that involves operation of lifting equipment within the safe working load that exceeds normal service.

*HVSA* – *High Visibility Safety Apparel*

*Normal Service*—Involves operation of lifting equipment with randomly distributed load within the rated load limit or uniform load of less than (<) 65% of rated load limit for no more than 25% of the time for a normal work shift.

*Powered Mobile Equipment*—a self-propelled machine or combination of machines, including a prime mover designed to manipulate or move material.

*PPE*—Personal Protective Equipment

*Qualified* - one who, by possession of a recognized degree, certificate, or professional standing, or who by knowledge, training and experience, has successfully demonstrated their ability to solve or resolve problems relating to the subject matter, the work, or the project

*ROPS*—Rollover Protection Structure

*Swing Radius*—the maximum reach of a boom/attachment and all contents (e.g., logs, boulders, construction materials), in all directions from the cab of the equipment. For example, an excavator with a 10 m boom and bucket reach would have a swing radius of 10 m in all directions from the cab, plus any additional allowance for materials being transported.

## **5.0 ROLES & RESPONSIBILITIES**

Operators shall:

- Comply with Enbridge driving requirements (see prerequisites), policies and procedures;
- Comply with all other driving-related Enbridge policies and procedures (e.g., driver responsibilities, recordkeeping, conduct and discipline, drug and alcohol, distracted driving, load security, log books and inspection standards);
- Complete training in the use of required safety equipment (e.g., warning devices, fire extinguishers, PPE, etc.);
- Operate equipment in safe operating condition;
- Only operate equipment for which they have the required specialized licenses or certificates (if applicable) or have obtained training and demonstrate competency to operate the equipment. Documentation must be made available upon request;
- Obey all traffic signals and posted speed limits;
- Only operate properly equipped and maintained equipment;
- Be responsible for the safe operation and movement of the equipment; and
- Ensure work area is set up appropriately for equipment operation.

Signallers/spotters shall:

- Know and use appropriate hand signals;
- Complete any specific training required by applicable legislation and/or as required by the company in charge of the lift;
- Wear appropriate PPE to distinguish themselves from other workers if applicable, Class 2 HVSA;
- Stop equipment when hazards are observed, and inform operators and workers of people entering the immediate work area; and
- Observe and communicate on the movement of the equipment.

People leaders shall:

- Ensure operators are competent on the equipment they are operating; and



- Ensure work area is set up appropriately for equipment operation.

## **6.0 STANDARD – SPECIFIC REQUIREMENTS**

### **6.1 POWERED MOBILE EQUIPMENT**

#### **6.1.1 SAFE OPERATING REQUIREMENTS FOR POWERED MOBILE EQUIPMENT**

Powered mobile equipment shall:

- Have seatbelts (exception for elevated work platforms (EWPs) and scissor lifts);
- Be equipped with engineered roll over protection structure (ROPS) (exception for EWPs and scissor lifts);
- Have manufacturer-installed horns that are functional;
- Have audible, functional back-up alarms;
- Have all required functional lighting;
- Have fire suppression equipment suitable for the equipment (as per manufacturer's guidelines);
- Have access/egress routes clear of obstructions;
- Be parked in an acceptable location that allows for access and egress with no added obstacles;
- Use wheel chocks when on an incline or there is a potential for unintentional movement (specific to Powered Mobile Equipment with wheels)
- Have appropriate placards on the unit as per regulatory requirements; and
- Have a log book readily available for all equipment used for lifts.

Workers operating powered mobile equipment shall:

- Wear seatbelts;
- Use agreed-upon horn signals;
- Complete pre-use inspection as per manufacturer's specifications;
- Ensure lighting is functional and used as necessary;
- Comply with all site traffic control plans;
- Wear Class 2 High Visibility Safety Apparel (HVSA) as a minimum whenever entering or exiting the cab of the equipment;

- Wear appropriate PPE as per hazard assessment when operating the equipment with an open door and/or window, if the cab of the equipment is not protected from the outdoor elements;
- Not use communication devices or allow other distractions during operation excluding 2-way radio communication when deemed necessary by hazard assessment;
- Not climb or allow others to climb powered mobile equipment while in motion;
- Not allow other workers to ride on powered mobile equipment, except in the seats provided (ensuring that all passengers wear seatbelts);
- Ensure keys are removed and equipment locked when daily work activities are completed;
- Use three points of contact whenever entering, exiting, or climbing ladders/designated points of access on equipment;
- Maintain adequate separation from all above and below grade facilities;
- Ensure mats are not stacked higher than the side boards on forwarders used to haul mats;
- Ensure cable guards, mesh/screen protectors, are installed before using a winch on tractors and other equipment;
- Adhere to the capacity ratings during operation;
- Make the unit inoperative and ensure it is in a safe state prior to exiting the equipment; and
- Use a signaller/spotter as required in the signaller/spotter section of this standard.

**Swing Radius and Path of Travel Requirements:**

- Ensure the appropriate swing radius is identified and all hazards within the area are noted and controlled;
- Ensure there is sufficient space when rotating the cab or when maneuvering through tight spots;
- Limit equipment use in congested work zones unless a clear work plan is established and communicated to affected workers;
- Additional spotters may be required in congested areas based on hazard assessment; and
- Workers walking with, or guiding, pipe, fittings, etc. are not standing in the fall zone. This includes but is not limited to moving pipe along the right of way, feeding bending machines, or handling piping around boring operations (track bores, cradle bores, etc.).

---

### **Positive Approach Confirmation Requirement**

When approaching or passing equipment on foot or by vehicle (within 6 m (20 ft) of equipment or swing radius), the worker shall:

- Stop at least 6 m (20 ft) from equipment or swing radius and await positive acknowledgement from equipment operator via radio or visual contact;
- Confirm with the operator that it's safe to approach or pass the equipment; and
- Ensure that the attachment/implement (if applicable) is grounded before proceeding.

Operator shall confirm that worker/vehicle is out of operating radius plus the furthest material deposit radius before lifting attachments/implements and resuming work.

### **6.1.2 ELEVATED WORK PLATFORMS**

Elevated work platforms (EWP) with articulating boom and extended boom platforms shall be operated by qualified operators.

Operators shall document daily checks on each EWP before use.

EWPs shall:

- Have easily accessible upper (platform) and lower ground controls, with their functions clearly marked and tested each day prior to use;
- Have lower controls that are capable of overriding the upper controls (lower controls shall only be operated in an emergency, unless the worker in the lift has given permission);
- Have a qualified operator readily available in the work area to operate lower controls in the event of an emergency;
- Only be used on a firm, level surface with the brakes set and outriggers positioned (if equipped) on pads or a solid surface; use wheel chocks when on an incline;
- Have the load rating posted (load rating shall not be exceeded);
- Have platforms that meet manufacturer's specifications and are designed and certified by a professional engineer;
- Have an anchor point specified by the manufacturer;
- Be inspected by a qualified person as required by manufacturer's specifications and applicable legislation;
- Have current inspection sticker visible and up to date; and
- Have owner's manual located on the work platform in a weatherproof container.

EWPs shall not:

**Uncontrolled if Printed or Downloaded**

- Be used for anything other than lifting workers, tools and materials to an elevated worksite;
- Be used as a crane or hoist; and
- Have loads placed or carried outside the platform perimeter or exceed the manufacturer's weight limit.

When in a EWP on mobile equipment, workers shall:

- Use a travel restraint system consisting of a full body harness and lanyard connected to an anchor point specified by the manufacturer;
- Have lanyards short enough to prevent the worker from being ejected from the work platform or elevated device, but long enough to allow the worker to perform their work;
- Tie off to the attachment point at all times when elevated, including when entering, exiting or maneuvering;
- Climb in or out through a doorway;
- Maintain 100% tie off at all times;
- Not stand on rails or objects inside the platform; and
- Not tie off to an adjacent pole, structure, or equipment while working from the platform.

### **6.1.3 TRACKED EQUIPMENT**

All tracked equipment shall be equipped with cleats or grouser bars to ensure maximum traction in frozen conditions. This also applies when mud or loose terrain is a concern and slippage is a potential risk based on a hazard assessment.

Traction aids may be applied after equipment is walked onto a site provided a prior assessment of access has been completed to address any concerns. Traction aids shall be in place prior to any excavation activity.

### **6.1.4 EXCAVATION EQUIPMENT FOR LIFTING**

When using excavating equipment (e.g., gradalls, backhoes) for material lifting, follow these requirements:

- Only a factory-supplied lift point shall be used, e.g., a welded plate with an eye, or a bolted-on hook with a safety latch;
- Slings shall be connected to the lifting point of the load with a clevis or shackle;
- Unattended loads shall be grounded or blocked in position;

- Ensure the lifting capacity chart for the specific piece of equipment is permanently affixed to the machine and legible and visible to the operator;
- Ensure a magnetic particle inspection report, dated within the previous twelve months. The report shall certify the fit condition of the lifting point and its method of attachment, e.g., welds, bolts;
- Visually inspect the lifting point before each lift;
- Ensure bolts used to attach hooks or other attachment points are rated higher than the lifting capacity of the lifting equipment;
- Ensure materials/load is always in motion and not suspended due to potential for hydraulic drift unless equipped with a manufacturer-installed lock valve; and
- The load should be lowered to the ground when the equipment is unattended.

### **6.1.5 SIDE BOOMS**

Side booms shall:

- Not be loaded beyond manufacturer's specified capacity;
- Not have the counter weight supplemented by the use of equipment or other devices;
- Have a seat belt which shall be worn by the operator when the side boom is in use;
- Be equipped with roll over protection structure certified by a professional engineer;
- Have adjustment of brake tensions performed by a qualified heavy duty mechanic, in accordance with the manufacturer's specifications;
- Have the hydraulic shut-off switch engaged (when equipped) when the unit is left unattended and idling;
- Have tracks on the ground at all times;
- Have sufficient load line on the drum to be able to safely handle pipe on deep ditch or bell holes;
- Utilize appropriate controls when it is necessary to stage/park heavy equipment on or near a slope;
- Function test all safety devices (i.e., hydraulic shutoff pin, kickout pin, brakes, clutches etc.);
- Have a daily check completed on the functioning of the boom cut-out valve; and
- Not have carried loads secured by using the boom lines.

---

### **6.1.6 BOOM/ PICKER TRUCKS**

When a boom/picker truck is traveling around the site, ensure booms and knuckles are in a proper resting position to avoid damage or hazards such as overhead power lines or cable trays.

Loads carried on boom trucks shall:

- Be adequately secured to prevent movement in the event of a roll-over; and
- Not be secured by using the boom lines.

### **6.1.7 DITCHING MACHINES**

Follow these requirements related to ditching machines:

- Follow manufacturer's recommendations when wiping, oiling, adjusting cleaning, or repairing the machine;
- Shut down all power units before leaving the controls when the operator is required to carry out any of the above-mentioned functions unassisted;
- Operate ditching machines only if machine guards are installed and properly maintained;
- Keep helpers in sight or know where they are at all times when operating ditching machines;
- Do not undertake manual cleaning of buckets when the digging wheel is in operation; and
- Do not leave the controls of the machine unless the main transmission and digging wheel are out of gear and the traveling brakes set.

### **6.1.8 CRANES**

General Crane requirements:

A crane shall only be erected when ground conditions are safe enough to allow for stable/firm placement and all other potential hazards have been eliminated or controlled.

All cranes shall have a power-controlled lowering system that is capable of handling rated loads and speeds as specified by the manufacturer of the crane. When power-operated brakes that have no continuous mechanical linkage between the actuating and braking means are used, an automatic means shall be provided to set the brake to prevent the load from falling in event of loss of brake-actuating power.

---

Guards shall be used:

- If hoisting ropes run close enough to other parts to make fouling or chafing possible; and
- When exposed moving parts and rotating equipment might constitute a hazard under normal operating conditions.

Crane Operators shall follow these requirements:

- When a crane is traveling around the site, carry the boom in line with the direction of travel and ensure booms are in a proper resting position. If this is not possible, then perform a hazard assessment and comply with controls;
- When traveling, ensure lock pin in place (positive house lock engaged);
- Lower conventional crane booms with the winch engaged, not by brake alone (not for hydraulic cranes);
- Maintain the safe limits of approach to any utility at all times;
- Ensure an unloaded boom has the empty hook lashed or otherwise restrained so that it cannot swing freely when in motion;
- Ensure the boom attachment, when in motion, is not positioned at more than 30 degrees from the vertical position;
- Cranes shall be equipped with an anti-two-block warning device;
- Check the brake when lifting the load above ground level; if there is any slippage, stop the operation. The brake shall be repaired or replaced before the equipment is returned to service; and
- Follow manufacturer's specifications in regards to reduced ratings or capacities of the crane under specified temperatures.

### **Crane Inspections**

All Cranes shall:

- Have annual inspection record readily available;
- Have a current equipment log book readily available; and
- Have all written records including all certifications, maintenance records, inspection records for lifting equipment readily available.

Any lifting component shall be inspected annually using one of the following non-destructive testing methods:

- X-ray;
- Magnetic particle; or
- Dye penetration.

Wire ropes on electric hoists shall be inspected to confirm:

- Hoisting ropes are secured to the drum by at least 2 wraps when the hook is in the lowest position;
- Winch lines are free of knots; and
- The number and spacing of clips conforms to manufacturer's specifications.

Intern or apprentice operators may be permitted to operate equipment once hoisting and rigging training has been completed, but only under the supervision of a qualified operator.

## **6.2 EQUIPMENT INSPECTION**

Follow these requirements for inspections:

- For equipment in normal service, inspect at least once per year, or as specified by the manufacturer;
- For equipment in heavy service, inspect at least every 6 months, or as specified by the manufacturer;
- For equipment that is idle for 6 months or more, complete a full formal inspection prior to use;
- For vacuum lifts, inspect 3 times daily and document; to ensure the integrity of the equipment;
- All pipe vacuum lifts shall have an inspection certification; and
- Hoists, cranes and lifting equipment that include hooks, in accordance with the manufacturer's specifications, shall be inspected by a competent person before use and at least once annually by a certified inspector.

### **Pre-use Inspection**

All pre-use inspections shall include but are not limited to:

- A walk-around of the equipment,
- A documented pre-use inspection of:
  - Controls, indicators and warning lights;



- Limits of the equipment;
- Equipment blind spots.
- Proper adjustment of operating mechanisms;
- Excessive wear or deterioration of components and accessories (e.g., cranes, boom pins, sheave blocks); and
- Damage that prohibits the safe operation of the equipment.

Inspect hydraulic hoses, fittings and tubing (particularly hoses that flex in normal operation) for the following:

- Leaks at threaded or clamped joints;
- Leaks at the surface of flexible hose; and
- Blistering of hoses.

Hydraulic relief valve settings shall never exceed specified pressure.

Equipment deficiencies shall be reported to immediate supervisor. If deficiencies pose a potential safety hazard, the equipment shall not be operated until cleared by a certified mechanic.

### **6.3 SIGNALERS AND SPOTTERS**

Signalers/spotters shall be used when:

- Parts of the work area could potentially be obscured;
- Equipment is backing up or moving, and the operator cannot see all parts of the equipment and its path of travel;
- Equipment is backing up or moving in congested areas;
- Equipment make turns with restrictive side clearances;
- Equipment or parts of equipment may reach the safe limits of approach (e.g., overhead power lines and communication lines),
- Movement of equipment may result in the operator and/or other workers being exposed to additional hazards; and
- Excavating.

The signaler/spotter shall:

- Stop equipment when hazards are observed, and inform operators and workers of people entering the immediate work area;
- Communicate with the operator, either verbally or through agreed upon hand signals;
- Ensure there are no hazards present that might endanger a worker;

**Uncontrolled if Printed or Downloaded**

- Alert workers to any hazards that arise while material is being moved when the view of the operator is obscured;
- Establish and maintain eye contact with the operator;
- Remain clearly visible to the operator at all times;
- Stand far enough behind, or in front of, the equipment to observe the positioning/backing path and any obstructions, and to allow for sufficient stopping distance in an emergency;
- Stay clear of the equipment blind spots or line of fire and not walk backwards;
- Be clearly identified, distinguishable from other workers, by wearing, at a minimum, Class 2 HVSA; and
- Complete any prescribed training required by applicable legislation in the jurisdiction where the signaler/ spotter is performing signaling duties.

Hand signals shall:

- Be used by the signaler/spotter when directing equipment; and
- Be agreed upon and understood by both the operator and signaler/spotter prior to moving equipment.

The operator shall take direction from only one signaler. However, anyone can give a STOP signal and the operator and/or spotter shall comply.

Communication between the operator and signaler/spotter shall be maintained. If the ability to transmit signals is interrupted at any time, the operator shall safely stop operations requiring signals until communication is re-established and a proper signal is given and understood. If eye contact is not possible or more than one spotter/signaler is used, a means of communication shall be established as part of the hazard assessment. If electronic communication is required, then that equipment shall be tested on-site before beginning operations to ensure that the signal is effective, clear, and reliable.

## **7.0 TRAINING REQUIREMENTS**

Personnel working in the field must be knowledgeable in this Standard and may be assigned applicable training as driven by the Safety Training Matrix.

Reference the Health & Safety training syllabi and matrices for further information and training re-certification requirements.

## **8.0 RELATED DOCUMENTS**

Hoisting and Rigging Standard

Where Do I Stand?: An Operator's Guide to Train Spotters

## 9.0 STANDARD REVIEW

A subject matter expert (SME) will perform a technical review of this standard every two years to determine the accuracy of the content/information. The SME shall solicit input from applicable stakeholders to ensure the effectiveness of the standard. Any suggested changes must be reviewed and approved by the designated document owner.

## 10.0 REFERENCE

Not applicable

## CHANGE LOG

Section	Version 1.3	Version 1.4
Entire document		Clerical corrections including spelling, grammar, and document names.

<End of Document>



---

# Standard

---

## Respiratory Protection

---

**Effective Date:** 2019-03-30

**Version #:** 2.0

**Version Date:** 2024-03-28

---



This page intentionally left blank



**Document Version Register**

<b>Version Number</b>	<b>Version Date</b>	<b>Approved By</b>	<b>Section Number and Title</b>	<b>Details of Version</b>
1.0	2019-03-30	Sean Evans	Whole Document (New Standard)	This is the new H&S standard that was developed as part of the LP   MP Safety Manual Transition Project
1.1	2020-06-01	Sean Evans	2.0 , 5.0	Alignment with Contractor Safety Specifications
1.2	2021-12-01	Murray Evenson	9.0, 10	Updated section 9 to reflect the appropriate review process Updated section 10 reference
2.0	2024-03-28	Troy Croft	All sections 11.1, 11.3	Clerical corrections See change long

**Uncontrolled Copy if Printed or Downloaded**

**Internal Information**





This page intentionally left blank



## Table of Contents

1.0	Purpose .....	3
2.0	Scope .....	3
3.0	Prerequisites.....	3
4.0	Definitions & Acronyms .....	3
5.0	Roles & Responsibilities.....	5
6.0	Standard-Specific Requirements .....	7
6.1	Respirator Selection .....	7
6.1.1	Voluntary Use of Filtering Facepiece Respirators (“Dust Masks”) .....	9
6.2	Medical Evaluation .....	9
6.3	Fit Testing .....	9
6.4	Respirator Use.....	10
6.4.1	Air Purifying Respirators.....	10
6.4.2	Self-Contained Breathing Apparatus (SCBA).....	11
6.4.3	Use of Supplied Breathing Air and Systems Requirements .....	11
6.5	Maintenance and Care of Respirators.....	12
6.5.1	Cleaning.....	12
6.5.2	Storage .....	12
6.5.3	Inspection .....	12
7.0	Training.....	12
8.0	Related Documents .....	13
9.0	Standard Review .....	13
10.0	References .....	13
11.0	Appendix.....	14
11.1	Facial Hair Examples.....	14
11.2	Supplied Breathing Air and Systems Requirements .....	15
11.3	RPE For Exposure Concentrations Table .....	17



---

Change Log..... 19

---

## **1.0 PURPOSE**

The purpose of this standard is to provide the minimum respiratory protection requirements and practices for Enbridge employees, contractors and subcontractors in order to protect them from airborne contaminants (i.e., particulates, oxygen (O<sub>2</sub>) deficiency, fumes, gases or vapors, smoke, sprays) during the course of their work activities and where it is determined that engineering controls are infeasible or inadequate to eliminate or sufficiently control the hazard.

## **2.0 SCOPE**

This standard applies to LP Operations and Projects being completed for LP.

Contractors and subcontractors shall comply with Enbridge health and safety requirements set out in this standard, as articulated within applicable contractor safety specifications. If a contractor or subcontractor has a health and safety standard or policy materially different from Enbridge's, the contractor/subcontractor shall follow the most stringent requirement. Contractors and subcontractors are still obligated to meet the requirements of all applicable laws related to this standard.

In the event a contractor's or subcontractor's standard exceeds the requirements of this standard, Enbridge may, in its sole discretion, choose to adopt the contractor's or subcontractor's standard for any given contract or work order.

Any deviation to this standard is required to be approved by the appropriate Vice President or designate responsible for the work. Deviations shall be applied for using the OHSMS Deviation Request Form located on the GDL. All deviations are applicable only to a specific project or Standard and do not create policy. All deviations shall be reviewed during annual reviews of the Safety Standards. Contractor deviations shall be reviewed as part of the Contractor Health and Safety Management System assessment. A deviation shall always be in compliance with Applicable Legislation.

## **3.0 PREREQUISITES**

Atmospheric Monitoring Standard

Hazard Assessment and Control Standard

Industrial Hygiene Standard

Immediately Dangerous to Life and Health Atmospheres Procedure

Inspection Standard

Safe Work Permit and Work Authorization Standard

## **4.0 DEFINITIONS & ACRONYMS**

*Action Level*—half of an occupational exposure limit.

*Air-Purifying Respirator (APR)*—a respirator with an air-purifying filter, cartridge or canister that removes specific air contaminants by passing the air through the purifying element.

*Assigned Protection Factor (APF)*—the workplace level of respiratory protection that a respirator or class of respirators is expected to provide to employees when the employer implements a continuing, effective respiratory protection program.

*Canister or Cartridge*—a container with a filter, sorbent, or catalyst, or combination which removes specific contaminants from the air passed through the container.

CO – carbon monoxide

*Engineering Controls*—physical changes to equipment and operations to reduce exposure to air contaminants. Engineering controls may include: adding local exhaust ventilation, changing to better equipment that release less air contaminants and enclosing operations to prevent exposure.

*Filtering Facepiece (Dust Mask)*—a negative pressure particulate respirator with a filter as an integral part of the facepiece or with the entire facepiece composed of the filtering medium.

*Fit Test*—a protocol for the qualitative or quantitative evaluation of the fit of a respirator on an individual.

*Immediately Dangerous to Life or Health (IDLH)*—an atmosphere that poses an immediate threat to life, would cause irreversible adverse health effects, or would impair an individual's ability to escape from a dangerous atmosphere.

LEL – Lower Explosive Limit

*Negative Pressure Respirator (Tight Fitting)*—a respirator in which the air pressure inside the facepiece is negative during inhalation with respect to the ambient air pressure outside the respirator.

*NIOSH "Certified" Respirator*—a respirator meeting the requirements of 42 CFR Part 84. All respirators approved by NIOSH have an approval number that looks like this: TC-84A-111 or TC-23C-222. A respirator is "approved" for a specific set of circumstances and conditions. If the particular circumstances or conditions of use exceed those for which it was approved, the respirator may provide inappropriate protection and is no longer considered to be approved. The following are examples of things you can do to invalidate the approvals: altering the respirator in any way such as by removing a strap or interchanging parts; using an air-purifying respirator equipped with organic vapor cartridges for an organic vapor with poor warning properties; using an air-purifying respirator equipped with organic vapor cartridges for an organic vapor at concentrations above the maximum use concentration established by OSHA or NIOSH.

*NIOSH*—National Institute for Occupational Safety and Health

*Occupational Exposure Limit (OEL)*—a regulatory limit that sets a standard measure that shall not be exceeded for specific contaminants and work durations (usually a 15 minute or 8-hour time weighted average).

*Oxygen Deficient Atmosphere*—an atmosphere with oxygen content below 19.5% by volume.

*Physician Or Other Licensed Health Care Professional (PLHCP)*—an individual whose legally permitted scope of practice (i.e., license, registration, or certification) allows him or her to independently provide, or be delegated the responsibility to provide, some or all of the health care services required.

*Positive Pressure Respirator*—a respirator in which the pressure inside the respiratory inlet covering exceeds the ambient air pressure outside the respirator (e.g., powered air purifying respirators).

*Powered Air-Purifying Respirator (PAPR)*—an air-purifying respirator that uses a blower to force the ambient air through air-purifying elements to the inlet covering.

*Pressure Demand Respirator*—a positive pressure atmosphere-supplying respirator that admits breathing air to the facepiece when the positive pressure is reduced inside the facepiece by inhalation.

*Qualitative Fit Test (QLFT)*—a pass/fail fit test to assess the adequacy of respirator fit that relies on the individual's response to the test agent.

*Quantitative Fit Test (QNFT)*—an assessment of the adequacy of respirator fit by numerically measuring the amount of leakage around the face seal of a respirator.

*RPE* – Respiratory Protection Equipment

*Self-Contained Breathing Apparatus (SCBA)*—an atmosphere-supplying respirator for which the breathing air source is designed to be carried by the user.

*Supplied-Air Respirator (SAR) or Airline Respirator*—an atmosphere-supplying respirator for which the source of breathing air is not designed to be carried by the user.

## **5.0 ROLES & RESPONSIBILITIES**

People Leaders shall:

- Be knowledgeable and compliant to this standard;
- Ensure that employees are medically tested prior to use of a respirator by a physician or other licensed healthcare provider;
- Ensure qualitative/quantitative fit testing has been completed for required personnel;
- Select respiratory protection options with advisement from health and safety;
- Ensure sufficient number of respirator sizes and styles to ensure acceptance and fit;
- Ensure employees wear the proper respiratory protection when exposed to respiratory hazards;

- Monitor respirator use to ensure that respirators are used in accordance with their specifications;
- Ensure all employees required to use respiratory protection are properly trained;
- Ensure proper storage and maintenance of respiratory protection equipment; and
- Assist in the elimination of breathing hazards through engineering controls as the primary approach to worker protection.

Workers shall:

- Be knowledgeable and compliant to this standard;
- Wear the appropriate respiratory protection when working around a potential respiratory hazard;
- Obtain medical clearance and fit testing prior to required respirator use;
- Participate in the required respirator training activities; and
- Inspect, maintain and store the provided respiratory protection equipment.

Safety Team shall:

- Provide timely advice, support and assistance to people leaders and employees on the implementation of this standard;
- Assist people leaders in identifying respiratory hazards that may require respiratory protection;
- Assist employees with following fit testing procedures;
- Assist people leaders with the selection and purchasing of respiratory protection equipment;
- Provide technical support when requested by the field to ensure compliance with this section;
- Maintain or make accessible (when records are managed by a 3<sup>rd</sup> party vendor) to employees fit test and medical evaluation records required by the program;
- Provide oversight in the hazard assessments and PPE evaluations of employee work areas with potential exposures to hazardous atmospheres;
- Provide assistance in determining engineering controls and conducting work method evaluations to reduce or eliminate respiratory hazards;
- Establish and maintain contract with a vendor to provide mobile testing services;
- Provide assistance in developing the required respiratory protection training programs;

- Provide technical support when requested by the field to ensure compliance with this section; and
- Be responsible for the maintenance and continuous improvement of this standard.

Contractor shall, as articulated within the applicable contractor safety specifications:

- Have a written respiratory protection program that meets or exceeds this standard and all applicable legislation and provide their employees with all required respiratory equipment;
- Provide proof of medical evaluation upon request; and
- Provide fit testing to contractor personnel (by respective employer).

## **6.0 STANDARD-SPECIFIC REQUIREMENTS**

For protection from airborne contaminants, workers shall wear respiratory protection equipment (RPE), in accordance with this standard. Airborne contaminants and hazards can include, but are not limited to:

- Particulates (asbestos, silica);
- O<sub>2</sub> deficiency;
- Fumes;
- Gases or vapors;
- Smoke; and
- Sprays.

Workers may be required to wear any of the following, depending on the potential hazard:

- Self-Contained Breathing Apparatus (SCBA);
- Supplied-Air Respirator (SAR) or Supplied-Air Breathing Apparatus (SABA); and
- Air-Purifying Respirators (APR) (full-face, half-mask, or disposable).

Tight fitting respirators seal. Workers shall ensure that no items (e.g., facial jewelry) or facial hair impede the seal or use of the respirator. Workers who are required to wear respirators as per hazard assessment shall be clean-shaven where the face piece contacts the skin (reference Appendix 11.1). Facial hair is allowed as long as it does not protrude under the respirator seal, or extend far enough to interfere with the device's valve function.

Workers who must wear full-face respirators and require prescription lenses shall wear an appropriate eyeglass insert that can be used with the facepiece.

### **6.1 RESPIRATOR SELECTION**

---

A hazard assessment of the work area shall be conducted to determine the respiratory hazards present. The following factors shall be considered during the hazard assessment before selecting the type of respiratory protection:

- Oxygen concentration;
- Nature & physical state of airborne contaminants or biohazardous material;
- Concentration of airborne contaminants;
- Duration of worker exposure;
- Operators conditions, processes or tasks;
- Warning properties of the contaminants;
- Toxicity of the contaminants;
- Need for emergency escape;
- Cartridge end of service indicators / change out schedule;
- LEL and IDLH levels of contaminants; and
- Facilities sufficient to adequately clean, sanitize, and properly store the respirator after use.

Only respirators approved by the National Institute for Occupational Safety and Health (NIOSH) shall be used. Specific respirator types and cartridges to be used shall be determined based on an initial hazard assessment, initial air monitoring, past documented exposure data, Safety Data Sheets (SDS), and/or exposure modelling. Recommendations on respirator types per air sampling/monitoring results are provided in Appendix 11.3.

If the concentration of the contaminant is unknown or there is a potential for a hazardous atmosphere (e.g., work around open systems), assume the atmosphere is hazardous, perform exposure assessments and use RPE in accordance with Appendix 11.3).

Planned work should not take place in immediately dangerous to life and health (IDLH) environments. If an IDLH environment exists, or has potential to exist, then work shall stop until controls are in place to eliminate, control, or minimize the hazards to an acceptable level. If this is not possible, refer to the Immediately Dangerous to Life and Health Atmospheres procedure for approvals and process for working in an IDLH atmosphere.

To avoid working in IDLH environments, use the hierarchy of controls (elimination, substitution, engineering, administrative, PPE) to mitigate atmospheric hazards. If the hierarchy of controls does not mitigate atmospheric hazards to an acceptable level, then Enbridge employees shall use the IDLH work procedure found in the GDL (under Safety Management).

Note: IDLH values for some chemical exposures may be found in Appendix 11.3. A source of IDLH values for other chemicals may be found in the National Institute of Occupational Safety and Health online Pocket Guide: <https://www.cdc.gov/niosh/idlh/default.html>.



### **6.1.1 VOLUNTARY USE OF FILTERING FACEPIECE RESPIRATORS (“DUST MASKS”)**

Employees may choose to voluntarily use filtering facepiece respirators (dust masks) for minor maintenance activities for the prevention of nuisance dusts or particles and where it is unlikely due to the limited duration and extent of the work activity that a regulatory exposure limit would be exceeded (e.g., minor sweeping and or cleaning activities). If the employee voluntarily uses a dust mask, the following requirements shall be completed (where all other requirements in this standard would be exempted):

- Determination that the mask itself does not pose a hazard to workers; and
- For the U.S., Appendix D of CFR 1910.134 is provided to the worker.

### **6.2 MEDICAL EVALUATION**

Prior to the use of respiratory protection equipment (including fit testing), a medical evaluation of the employee shall be completed and reviewed by a licensed healthcare professional. The licensed healthcare professional shall provide a written recommendation along with any limitations regarding use of the respirator.

Specific testing such as pulmonary function or spirometry tests shall be conducted in accordance with applicable legislative requirements or at the recommendation of the PLHCP.

Note: The purpose of medical evaluation in this standard is solely to determine whether an employee is physically capable of wearing a respirator while completing their work tasks. Additional medical evaluations or medical tests may be required for occupational health screening purposes, which is dependent on the specific chemicals (i.e., asbestos, silica, benzene, lead) and exposures of the occupation and local regulations.

Medical evaluations shall be completed:

- Initially upon hire (at a minimum a medical questionnaire that is reviewed by a PLHCP);
- Annually (at a minimum a questionnaire that asks the employee whether any significant changes have occurred where it can then be determined if a medical examination would be necessary);
- When an employee reports medical signs or symptoms that may affect their ability to wear a respirator;
- Observations made during fit testing indicate the need for re-evaluation; and
- An environmental, physical, or task change occurs in the workplace that may increase the usage or physical and psychological load placed of the employee when using a respirator.

### **6.3 FIT TESTING**

Fit testing is required for all respiratory protection that depends on an effective facial seal prior to initial use in the workplace (tight fitting respirators). Fit testing shall be completed for each size and model of respirator used by the employee.

Fit testing shall be carried out:

- Whenever there are any changes that would affect the respirator effectiveness, such as a physical change (weight loss, dentures, injuries to the face, etc.);
- When an employee receives a new respirator, and there is a change in respirator model and size;
- When there is a change in the workplace that would affect the use of the respirator; and/or
- On an annual reoccurring basis as set by applicable regulations.

Fit testing should be quantitative (preferred method), and fit testing procedures shall be completed by a trained individual that must follow procedures as set forth in applicable regulations (CSA Z94.4 Annex B, OSHA [appendix A to §1910.134—Fit Testing Procedures](#)).

When respirators used for fit testing are not individually assigned, cleaning and sanitizing shall be performed before the next use.

## **6.4 RESPIRATOR USE**

Where there is an existing or potential for an atmospheric hazard:

- Continuous monitoring of the work area shall occur to ensure atmospheric conditions don't change. If atmospheric conditions significantly change, the hazard assessment shall be updated and additional controls put in place, including reassessing the level of RPE being used per Appendix 11.3.
- Appropriate surveillance shall be maintained of work area conditions and degree of worker exposure or stress. When there is a change in work area conditions or degree of worker exposure or stress that may affect respirator effectiveness, the site supervisor shall reevaluate the continued effectiveness of the respirator.
- Respiratory protective equipment must be used as per manufacturer's instructions and is not to be modified in any way.

### **6.4.1 AIR PURIFYING RESPIRATORS**

Workers required to wear tight fitting respirators shall:

- Perform a positive and negative pressure user seal check, prior to use;
- Select or change the RPE used, based on results of contaminant/hazard monitoring and updated results;

- Leave the respirator use area if vapor or gas breakthrough is detected, or if there are changes in breathing resistance, or leakage of the face piece;
- Ensure that shared RPE is disinfected after each personal use; and
- Leave the area to change cartridges.

#### 6.4.1.1 Cartridge change out

Workers wearing air purifying respirators (APR) shall replace cartridges when:

- Cartridge has been used for escape from H<sub>2</sub>S concentrations greater than (>) 10 ppm;
- Cartridge is damaged;
- There is odor breakthrough;
- Cartridge is past the expiration date;
- Organic Vapor (OV) Acid Gas (AG) cartridges have been used continuously for 10 hours or when opened 30 days prior, whichever comes first;
- Cartridge usage exceeds manufacturer's specifications;
- Cartridge is plugged, damaged or soiled; and
- Hazard assessment determines cartridges require replacement.

If used in environments containing oil aerosols, the worker shall replace an oil proof filter (p type aerosol filters such as the "P100") after a total of 40 hours use or when opened 30 days prior, whichever comes first.

#### 6.4.2 SELF-CONTAINED BREATHING APPARATUS (SCBA)

All SCBA respirators shall be of the positive pressure type.

Workers wearing SCBA or SAR with escape pack shall:

- Be properly trained (at a minimum, training requirements are set forth in the Enbridge training matrix) and fit tested prior to using the equipment;
- Leave the area containing the hazardous atmosphere when the alarm sounds or when 20–25% of the operating time remains (SCBA); and
- Not remove the face mask while in the area containing the hazardous atmosphere.

#### 6.4.3 USE OF SUPPLIED BREATHING AIR AND SYSTEMS REQUIREMENTS

Workers using supplied air systems shall have a bottle watch to ensure constant breathing air supply to workers at all times when using supplied air.

Compressed air breathing systems air quality must meet additional regulatory requirements. Refer to Appendix 11.2 for additional information.

---

## **6.5 MAINTENANCE AND CARE OF RESPIRATORS**

### **6.5.1 CLEANING**

Employees shall clean and disinfect their respirators after each use per manufacturer's recommendations.

### **6.5.2 STORAGE**

All respirators shall be stored to protect them from damage, contamination, dust, sunlight, extreme temperatures, excessive moisture, and damaging chemicals.

### **6.5.3 INSPECTION**

All respirators shall be inspected prior to use and during cleaning.

All respirators maintained for emergency use shall be inspected on a monthly basis or in accordance with manufacturer's recommendations, and shall be checked for proper function before and after each use.

Workers shall inspect and record information about SCBA and SAR escape packs on a monthly basis. The inspection and information shall include labeling each respirator or storage bag with:

- Inspection date;
- Name of worker completing the inspection;
- Findings, including remedial action required; and
- Serial number or other identification.

All required documented Inspection records shall be kept on-site for one year.

## **7.0 TRAINING**

Personnel working in the field must be knowledgeable in this Standard and may be assigned applicable training as driven by the Safety Training Matrix.

Reference the Health & Safety training syllabi and matrices for further information and training re-certification requirements.

Training shall be completed initially and annually thereafter for all employees required to use respirators as part of their job functions. Training shall include at a minimum the following:

- When to use the respirator;
- Proper fit of the respirator;
- The limitations and capabilities of the respirator;
- Effective use of the respirator during emergencies;

- 
- Maintenance and storage of the respirator to include inspection;
  - Recognition of medical signs and symptoms that may limit or prevent the effective use of the respirator;
  - When to change-out respirator cartridges, specifically as listed in 6.4.1.; and
  - Use of respirators in low temperature and extremely low temperature environments.

## **8.0 RELATED DOCUMENTS**

Book 6, Breathing Air Compressors

Book 6, Self-Contained Breathing Apparatus (SCBA)

Confined Space Entry Standard

Immediately Dangerous to Life and Health Atmospheres Procedure

## **9.0 STANDARD REVIEW**

A subject matter expert (SME) will perform a technical review of this standard every two years to determine the accuracy of the content/information. The SME shall solicit input from applicable stakeholders to ensure the effectiveness of the standard. Any suggested changes must be reviewed and approved by the designated document owner.

## **10.0 REFERENCES**

Canada Labour Code, Part II: Respiratory Protection 12.13

CSA Z94.4 Selection, Use, and Care of Respirators

OSHA 1910.134 Respiratory Protection

## 11.0 APPENDIX

### 11.1 FACIAL HAIR EXAMPLES

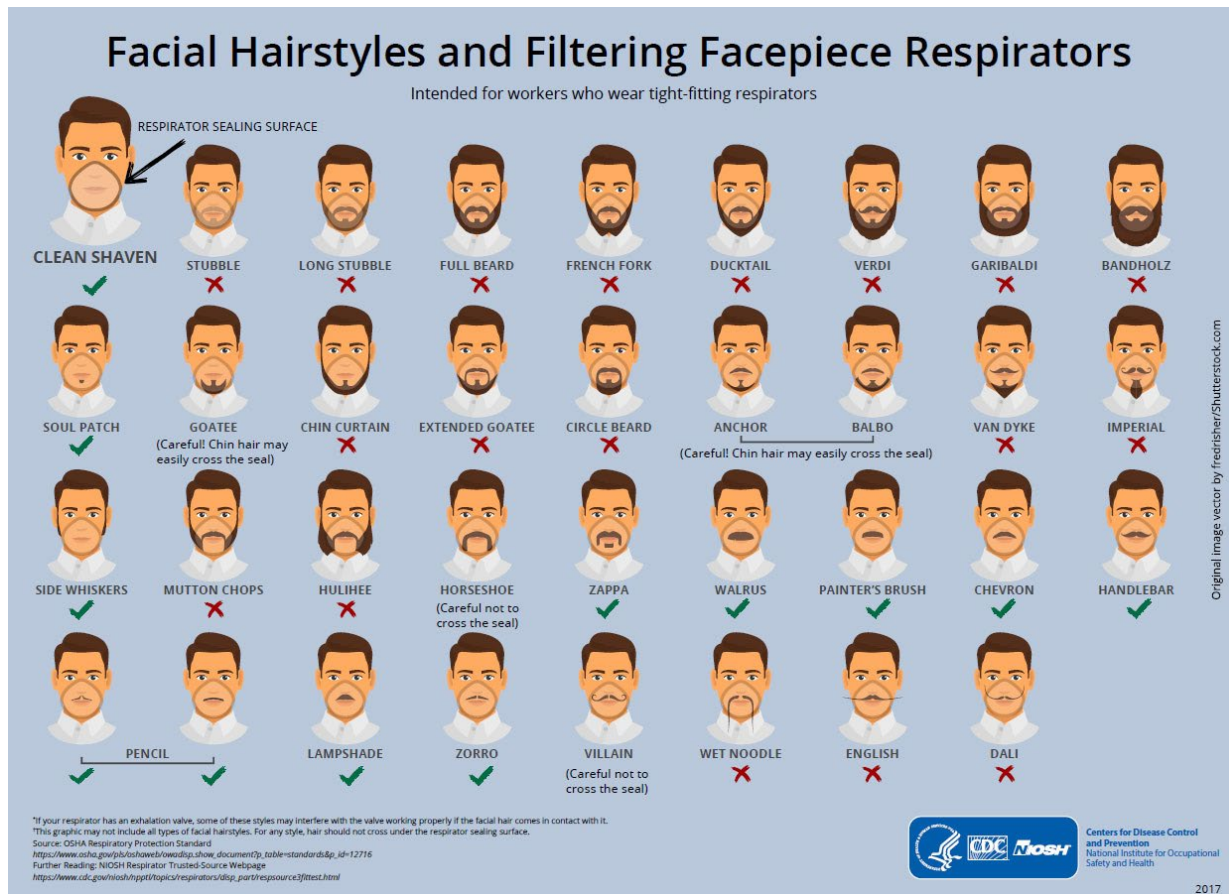

Source: <https://www.cdc.gov/niosh/nppt/images/infographics/FacialHairWmaskLG.jpg>

---

## **11.2 SUPPLIED BREATHING AIR AND SYSTEMS REQUIREMENTS**

Compressed breathing air and systems used to supply breathing air to RPE shall meet the requirements of:

- CSA Z180.1 Compressed breathing air and systems (CAN), and/or
- ANSI/Compressed Gas Association Commodity Specification for Air, G-7.1 (USA) (OSHA 1910.134(i)(1)(ii))

The compressed breathing air shall be sampled and analyzed as per industry standards and applicable legislation. The air quality analysis results shall be readily available. Compressed breathing air and systems shall be inspected and maintained in accordance with manufacturer's specifications, applicable legislation and industry standards. Written records of analysis results, inspections and maintenance shall be kept according to the record retention policy.

Carbon monoxide (CO) levels shall be continuously monitored with an in-line monitoring system for compressed breathing air systems using oil-lubricated compressors. This in-line monitoring system shall consist of:

- Audible or/and visible alarms at 5 ppm,
- Detection limit of 1 ppm and a resolution of at least 1 ppm, and
- An inspection, maintenance and calibration program in accordance with manufacturer's specifications.

In-line carbon monoxide monitoring is not required for ambient air systems or compressed breathing air systems comprised of compressed breathing air cylinders which have been filled in accordance with the applicable legislation.

In case ambient air systems are being operated in an environment where CO could get externally introduced into the system (running engines in the vicinity, etc.) the ambient air shall be tested for CO close to the air intake at least two times daily and when environmental or job conditions change.

Oil-lubricated air compressors used as a component of a compressed breathing air system shall:

- Have fail-safe switches that will activate audible and visual alarms, shut down the compressor, and prevent automatic restart when either the compressor's oil pressure is low or temperature is high,
- Have a high-pressure shutdown switch,
- Have check valves to prevent feedback of purified air,
- Have an instruction manual and manufacturer's recommended logbook, and
- Use oils for breathing air applications that are recommended by both the compressor and oil manufacturers.

The air intake for the compressed breathing air system shall be situated and installed in accordance with manufacturer's specifications and designed to minimize the intake of contaminants. Atmospheric monitoring of the work area may be required to ensure atmospheric contaminants are not drawn into the compressed breathing air system.

Breathing air couplings shall be incompatible with outlets for non-respirable worksite air or other gas systems.

Steel and aluminum SCBA Cylinders and emergency escape pack cylinders shall be hydrostatically tested every 5 years by a qualified service supplier. All other cylinders (e.g., carbon and fiberglass) shall be hydrostatically tested every three years by a qualified service supplier. Each SCBA shall be functionally tested in accordance with the manufacturer's specifications.

Enbridge employees may refer to the *Filling Air Cylinders with Cascade System* procedure in the OMM Book 3 to fill SCBA's and emergency escape packs.

Cylinders for hoseline breathing equipment shall be equipped with a pressure-reducing regulator to control hoseline pressure below 1380 kPa (200 psi).

Breathing hoses/airlines shall:

- Be a certified and compliant hose as rated and supplied by the manufacturer,
- Be protected from tangles, unnecessary wear and damage,
- Have fully-functional quick connectors with dual action locking fittings at all times (single action locking fittings shall not be permitted for use), and
- Not exceed the length per the manufacturer recommendations or a maximum of 91 m (300 ft.) in length with a maximum of 12 segments.



**11.3 RPE FOR EXPOSURE CONCENTRATIONS TABLE**

Respiratory Hazard	Exposure Concentration	Respiratory Protection
Asbestos	<1 f/cc	half-mask APR with P100 filter
	1 to 10 f/cc	full-face APR with P100 filter
	10 to 100 f/cc	full-face PAPR with P100 filter or SAR
	<1000 f/cc	positive demand or positive pressure SCBA
Benzene	0 to 0.5 ppm	none
	0.6 to 5 ppm	half-mask APR <sup>1</sup> with Organic Vapor (OV) cartridge
	6 to 25 ppm	full-face APR <sup>1</sup> or PAPR with OV cartridge or SAR
	>25 to 500 ppm	PAPR with OV cartridge, SCBA or SAR
	>500 ppm (IDLH) <sup>2</sup>	planned work is not permitted <sup>3</sup>
Carbon monoxide (CO)	25 to 1200 ppm	SCBA or SAR
	> 1200 ppm (IDLH) <sup>2</sup>	planned work is not permitted <sup>3</sup>
Hydrogen Sulfide (H <sub>2</sub> S)	0 to 10 ppm	none
	11 to 99 ppm	SCBA or Type C SAR with escape pak <sup>4</sup>
	>100 ppm (IDLH) <sup>2</sup>	planned work is not permitted <sup>3</sup>
Lead	<0.05 mg/m <sup>3</sup>	half mask APR with P100 filter
	0.05 to 2.5 mg/m <sup>3</sup>	full face APR with P100 filter
	2.5 to 50 mg/m <sup>3</sup>	full face PAPR with P100 filter or SAR
	50 to 100 mg/m <sup>3</sup>	positive demand or positive pressure SCBA
	≥100 mg/m <sup>3</sup>	planned work is not permitted
Ethyl Mercaptan, Butyl Mercaptan	0 to 0.5 ppm	none
	0.6 to 5 ppm	half-mask APR with OV cartridge
	6 to 25 ppm	full-face APR <sup>1</sup> with OV cartridge
	>25 to 500 ppm	PAPR with OV cartridge, SCBA or SAR
	>500 ppm (IDLH) <sup>2</sup>	planned work is not permitted
Oxygen deficiency	<19.5%	SCBA
Oxygen-displacing gases <sup>5</sup>	When oxygen is <19.5%	SCBA
Silica, crystalline	<0.25 mg/m <sup>3</sup>	half-mask APR with P100 filter
	0.25 to 2.5 mg/m <sup>3</sup>	full-face APR With P100 filter
	2.5 to 25 mg/m <sup>3</sup>	full-face PAPR with P100 filter or SAR
	≥25 mg/m <sup>3</sup>	planned work is not permitted
Other chemicals	See note 6	See note 6

Notes

- 1 If quantitative fit test performed.
- 2 Immediately Dangerous to Life and Health (IDLH)
- 3 Emergency work is allowed if SCBA or SAR with escape pack is used and all ignition sources are eliminated. Additional requirements for entering buildings can be found in the Industrial Hygiene Standard.

- 
- 4 If the concentration exceeds the maximum detection limit of the H<sub>2</sub>S detector, planned work is not permitted until the concentration has been verified.
  - 5 Oxygen-displacing gases displace oxygen in the atmosphere; therefore, entry into areas where oxygen levels are less than (<) 19.5% require SCBA. Some oxygen-displacing gases are methane, ethane, liquified petroleum gas (LPG), propane, natural gas, acetylene, argon, nitrogen, helium, and hydrogen.
  - 6 For any other chemical, contact your Occupational Hygienist.

**CHANGE LOG**

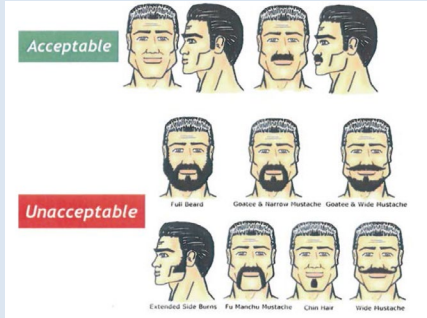
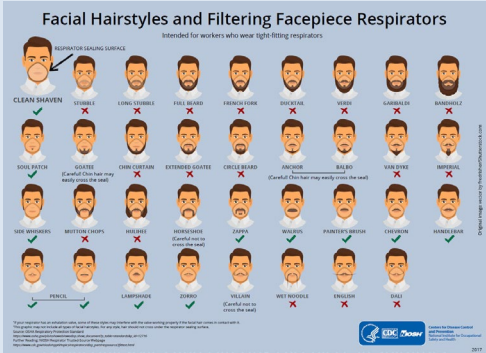
Section	Version 1.2	Version 2.0
Entire document		Clerical corrections including spelling, grammar, and document names.
11.1	 <p>Other acceptable examples may be found in CSA 94 appendix M or <a href="https://www.cdc.gov/niosh/nppt/images/infographics/FacialHairWmaskLG.jpg">https://www.cdc.gov/niosh/nppt/images/infographics/FacialHairWmaskLG.jpg</a></p>	 <p>Source: <a href="https://www.cdc.gov/niosh/nppt/images/infographics/FacialHairWmaskLG.jpg">https://www.cdc.gov/niosh/nppt/images/infographics/FacialHairWmaskLG.jpg</a></p>
11.3		<p>Added:</p> <ul style="list-style-type: none"> <li>- Guidance for the use of Powered Air-Purifying Respirators (PAPR)</li> <li>- Industrial Hygiene contact for other chemicals</li> <li>- Specified name of crystalline silica and ethyl/butyl mercaptans</li> <li>- Oxygen-displacing gases section</li> </ul> <p>Removed:</p> <ul style="list-style-type: none"> <li>- RPE requirements based on lower explosive limits (LEL)</li> </ul> <p>Revised:</p> <ul style="list-style-type: none"> <li>- Upper limit for SCBA/SAR use for carbon monoxide has changed from 500 to 1200 ppm</li> </ul>

**11.3 RPE FOR EXPOSURE CONCENTRATIONS TABLE**

Respiratory Hazard	Exposure Concentration	Respiratory Protection
Asbestos	<1 f/cc	half-mask APR with P100 filter
	1 to 10 f/cc	full-face APR with P100 filter
	10 to 100 f/cc	full-face PAPR with P100 filter or SAR
	<1000 f/cc	positive demand or positive pressure SCBA
Benzene	0 to 0.5 ppm	none
	0.6 to 5 ppm	half-mask APR with OV cartridge
	6 to 25 ppm	full-face APR <sup>1</sup> with OV cartridge or SAR
	greater than (>) 25 ppm	SCBA or SAR
	greater than (>) 500 ppm (IDLH) <sup>2</sup>	planned work is not permitted <sup>3</sup>
Carbon monoxide	25 ppm to 500 ppm	SCBA or SAR
	greater than (>) 500 ppm	planned work is not permitted <sup>3</sup>
Hydrogen Sulfide (H <sub>2</sub> S)	0 to 10 ppm	none
	11 to 99 ppm <sup>4</sup> greater than (>)100 ppm (IDLH) <sup>2</sup>	SCBA or Type C SAR with escape pak <sup>4</sup> Planned work is not permitted <sup>3</sup>
Lead (0.05mg/m <sup>3</sup> )	<0.05 mg/m <sup>3</sup>	half mask APR with P100 filter
	0.05 to 5 mg/m <sup>3</sup>	full face APR with P100 filter
	5 to 50 mg/m <sup>3</sup>	full face PAPR with P100 filter or SAR
	50 to 100 mg/m <sup>3</sup> greater than or equal to (≥) 100mg/m <sup>3</sup>	Positive demand or positive pressure SCBA planned work is not permitted
Mercaptans	0 to 0.5 ppm	none
	0.6 to 5 ppm	half-mask APR with OV cartridge
	6 to 25 ppm	full-face APR <sup>1</sup> with OV cartridge or SAR
	greater than (>) 25 ppm greater than (>) 500 ppm (IDLH) <sup>2</sup>	SCBA or SAR planned work is not permitted
Natural gas	0 to 10% LEL	none
	11 to 20% LEL greater than (>) 20%	SCBA for cold work; hot work is not permitted <sup>3</sup> planned work is not permitted <sup>3</sup>
Oxygen deficiency	less than (<) 19.5%	SCBA
Petroleum vapors	less than (<) 3% LEL	none
	greater than or equal to (≥) 3% LEL to less than (<) 10% LEL	half-mask APR with OV cartridge

Respiratory Hazard	Exposure Concentration	Respiratory Protection
	greater than or equal to (≥) 10% LEL to less than (<) 20% LEL	SCBA (or equivalent) for cold work; hot work is not permitted
	greater than or equal to (≥) 20% LEL (IDLH)	planned work is not permitted <sup>3</sup>
Silica (Exposure Limit .025)	<0.25mg/m <sup>3</sup>	half-mask APR with P100 filter
	0.25 to 2.5mg/m <sup>3</sup>	full-face APR With P100 filter
	2.5 to 25mg/m <sup>3</sup>	full-face PAPR with P100 filter or SAR
	greater than or equal to (≥) 25mg/m <sup>3</sup> (IDLH)	planned work is not permitted

**11.3 RPE FOR EXPOSURE CONCENTRATIONS TABLE**

Respiratory Hazard	Exposure Concentration	Respiratory Protection
Asbestos	<1 f/cc	half-mask APR with P100 filter
	1 to 10 f/cc	full-face APR with P100 filter
	10 to 100 f/cc	full-face PAPR with P100 filter or SAR
	<1000 f/cc	positive demand or positive pressure SCBA
Benzene	0 to 0.5 ppm	none
	0.6 to 5 ppm	half-mask APR <sup>1</sup> with Organic Vapor (OV) cartridge
	6 to 25 ppm	full-face APR <sup>1</sup> or PAPR with OV cartridge or SAR
	>25 to 500 ppm >500 ppm (IDLH) <sup>2</sup>	PAPR with OV cartridge, SCBA or SAR planned work is not permitted <sup>3</sup>
Carbon monoxide (CO)	25 to 1200 ppm	SCBA or SAR
	> 1200 ppm (IDLH) <sup>2</sup>	planned work is not permitted <sup>3</sup>
Hydrogen Sulfide (H <sub>2</sub> S)	0 to 10 ppm	none
	11 to 99 ppm	SCBA or Type C SAR with escape pak <sup>4</sup>
	>100 ppm (IDLH) <sup>2</sup>	planned work is not permitted <sup>3</sup>
Lead	<0.05 mg/m <sup>3</sup>	half mask APR with P100 filter
	0.05 to 2.5 mg/m <sup>3</sup>	full face APR with P100 filter
	2.5 to 50 mg/m <sup>3</sup>	full face PAPR with P100 filter or SAR
	50 to 100 mg/m <sup>3</sup> ≥100 mg/m <sup>3</sup>	positive demand or positive pressure SCBA planned work is not permitted
Ethyl Mercaptan, Butyl Mercaptan	0 to 0.5 ppm	none
	0.6 to 5 ppm	half-mask APR with OV cartridge
	6 to 25 ppm >25 to 500 ppm >500 ppm (IDLH) <sup>2</sup>	full-face APR <sup>1</sup> with OV cartridge PAPR with OV cartridge, SCBA or SAR planned work is not permitted
Oxygen deficiency	<19.5%	SCBA
Oxygen-displacing gases <sup>5</sup>	When oxygen is <19.5%	SCBA
Silica, crystalline	<0.25 mg/m <sup>3</sup>	half-mask APR with P100 filter
	0.25 to 2.5 mg/m <sup>3</sup>	full-face APR With P100 filter
	2.5 to 25 mg/m <sup>3</sup>	full-face PAPR with P100 filter or SAR
	≥25 mg/m <sup>3</sup>	planned work is not permitted
Other chemicals	See note 6	See note 6

<End of Document>



---

# Standard

---

## Right to Refuse Dangerous Work

---

**Effective Date:** 2019-03-30

**Version #:** 1.7

**Version Date:** 2024-03-28

---

**RIGHT TO REFUSE UNSAFE WORK  
STANDARD**

Version #: 1.7  
Version Date: 2024-03-28



This page intentionally left blank



**Document Version Register**

Version Number	Version Date	Approved By	Section Number and Title	Details of Version
1.0	2019-03-30	Sean Evans	Whole Document (New Standard)	This is the new H&S standard that was developed as part of the LP   MP Safety Manual Transition Project
1.1	2019-10-31	Sean Evans		See change log
1.2	2020-06-01	Sean Evans	2.0	Alignment with Contractor Safety Specifications
1.3	2021-12-01	Murray Evenson	9.0, 10.0	Updated section 9 to reflect the appropriate review process Updated reference (see change log)
1.4	2022-07-19	Jeff Safioles	6.1	See change log for details
1.5	2023-07-25	Jeff Safioles	4.0, 11.0	See change log for details
1.6	2023-09-21	Jeff Saioles	11.1	Update US and Can process flows into one
1.7	2024-03-28	Troy Croft	All sections 3.0, 6.1, 6.2, 6.3, 6.4, 11.1	Clerical corrections Alignment with Management System Framework - Event Analysis.

Uncontrolled Copy if Printed or Downloaded



This page intentionally left blank



---

## Table of Contents

1.0	Purpose .....	2
2.0	Scope .....	2
3.0	Prerequisite .....	2
4.0	Definitions & Acronyms .....	2
5.0	Roles & Responsibilities .....	2
6.0	Standard – Specific Requirements .....	3
6.1	Exercising the Right to Refuse Dangerous Work .....	3
6.2	Continued Refusal – Internal Analysis .....	4
6.3	Director Decision .....	4
6.4	Regulatory Notification .....	4
6.5	Appeals and Reprisal .....	5
7.0	Training Requirements .....	5
8.0	Related Documents .....	5
9.0	Standard Review .....	5
10.0	References .....	5
11.0	Appendix .....	6
11.1	Right to Refuse Dangerous Work Process Flow .....	6
	Change Log .....	7

---

## 1.0 PURPOSE

The purpose of this standard is to ensure that employees understand they have a right to refuse unsafe work and to provide people leaders with a defined process to follow in the event that an employee determines that they have a reason to believe that a hazard, condition or activity at the worksite is an imminent and immediate threat to life and health.

## 2.0 SCOPE

This standard applies to LP Operations and Projects being completed for LP.

Contractors and subcontractors shall comply with Enbridge health and safety requirements set out in this standard, as articulated within applicable contractor safety specifications. If a contractor or subcontractor has a health and safety standard or policy materially different from Enbridge's, the contractor/subcontractor shall follow the most stringent requirement. Contractors and subcontractors are still obligated to meet the requirements of all applicable laws related to this standard.

In the event a contractor's or subcontractor's standard exceeds the requirements of this standard, Enbridge may, in its sole discretion, choose to adopt the contractor's or subcontractor's standard for any given contract or work order.

## 3.0 PREREQUISITE

Event Analysis Process

## 4.0 DEFINITIONS & ACRONYMS

*Dangerous Work*—any hazard, condition or activity that could reasonably be expected to be an imminent or serious threat to the life or health of a person exposed to it before the hazard or condition can be corrected or the activity altered. The hazard, condition and/or activity that is considered dangerous cannot be a normal condition of employment.

*PIC* —Person In Charge

## 5.0 ROLES & RESPONSIBILITIES

Regional or project directors shall:

- Assign event analysis team personnel as required by standard; and
- Make final decision on dangerous work assessment as required by standard.

People Leaders shall:

- Ensure workers remain in compliance with OH&S acts and regulations;
- Ensure workers understand their right and responsibility to refuse dangerous work;
- Ensure workers use prescribed protective equipment devices either through periodic spot checks or regular checks

- Advise workers of potential and actual hazards;
- Provide workers with written instructions as to the measures and procedures to be taken to address the hazard, condition or activity that is an imminent and immediate threat to life and health;
- Take every reasonable precaution in the circumstances for the protection of workers at the worksite; and
- Complete analysis and corrective actions as applicable.

Employees shall:

- Work in compliance with OH&S acts and regulations;
- Be knowledgeable in this standard and willing to enact it when required on the worksite;
- Use personal protective equipment and clothing as directed by the employer;
- Report workplace hazards and dangers to people leader as defined by organizational process or standards;
- Work in a safe manner as required by the employer and use the prescribed safety equipment; and
- Notify people leader about any missing or defective equipment or protective device that is an imminent or serious threat to life or health.

Safety Team shall:

- Support People Leader with the interpretation and implementation of this standard; and
- Notify appropriate regulatory body as required by this standard.

Safety Shared Services shall:

- Be responsible for the maintenance and continuous improvement of this standard.

## **6.0 STANDARD – SPECIFIC REQUIREMENTS**

Any employee has the right and responsibility to refuse dangerous work as long as they have reasonable cause to believe that it presents a danger to themselves or another employee.

### **6.1 EXERCISING THE RIGHT TO REFUSE DANGEROUS WORK**

An employee wishing to exercise the right to refuse dangerous work shall immediately report the dangerous situation to their or any people leader. The employee shall also specify to the people leader whether he or she intends to pursue the matter under the applicable law (COHS, OSHA or provincial law) or under a collective agreement, when applicable, to deal with the refusal. However, the language in the agreement must provide protections to employees that meet or exceed the minimums provided legislation.

Upon being notified that the employee has exercised the right to refuse dangerous work, the people leader shall immediately analyze the situation in the presence of the employee reporting the concern. However, the analysis is conducted even if the employee or the person designated to represent the employee chooses not to be present. The people leader, at this point, cannot assign someone else to do the work that the employee refused to do. A written report must be completed by the people leader that includes immediate action to address the dangerous hazard, condition and/or activity. If the hazards have been effectively addressed and the concern(s) resolved, the refusing employee returns to work.

The EnCompass tool is utilized to complete the required written report.

NOTE: During isolation verification activities, if an isolation point is found to be tagged or labeled incorrectly or the tag/label is missing, any work taking place shall be stopped until the tag or label is corrected or replaced. Refer to section '6.6 – Lockout/Tagout Assurance Process for Asset Management' in the Controls of Hazardous Energy Safety Standard.

## **6.2 CONTINUED REFUSAL – INTERNAL ANALYSIS**

If the employee does not agree with the decision following the analysis, the employee can continue the refusal. The employee shall immediately report the continued refusal to the Health & Safety Team representative who will then notify the regional or project director. The director will immediately assign a people leader and two employees who were not part of the initial analysis to initiate a second analysis in the presence of the refusing employee and provide findings and corrective actions.

## **6.3 DIRECTOR DECISION**

After receiving the findings from the second analysis, the regional or project director will make the following decision:

1. A danger exists and immediate action is taken to protect the employee(s). If the corrective measures are taken and the employee agrees, he or she returns to work; or
2. A danger does not exist and the Director notifies the employee in writing.

If the employee agrees, he or she returns to work.

If the employee disagrees with the director decision, the employee shall notify the director that the refusal to work will continue.

## **6.4 REGULATORY NOTIFICATION**

If the employee continues to refuse the work, the Safety Team representative will notify the appropriate regulatory body (federal, provincial etc.).

Upon appropriate regulatory notification, the people leader may assign the employee to reasonable alternative work. The people leader cannot assign the refused work to another employee unless

they are qualified, advised of the work refusal/reasons and the regional or project director is satisfied it will not place the new employee in danger.

If the regulatory body proceeds with an analysis, it must be done in the presence of the people leader, the employee who made the refusal, Health & Safety Team representative and a member of the local health and safety committee if applicable. The regulatory representative shall provide a written decision immediately to Enbridge and the employee, calling for the employee to either return to work or with direction to the employer to take actions to protect employees. If directions are issued to Enbridge the employee can continue to refuse work until all the provided direction is complied with.

## **6.5 APPEALS AND REPRISAL**

There is an opportunity for appealing the regulatory body's decision. Contact the Health & Safety Team for additional information if required.

It is against the law to dismiss, suspend, layoff, demote, impose a financial or other penalty, discipline or threaten any employee performing their rights or duties to refuse dangerous work.

However, employers have the legal right to take disciplinary action against an employee if the employer can prove the employee wilfully abused their right to refuse. Contact the Health & Safety Team for additional information if required.

## **7.0 TRAINING REQUIREMENTS**

Personnel working in the field must be knowledgeable in this Standard and may be assigned applicable training as driven by the Safety Training Matrix.

Reference the Health & Safety training syllabi and matrices for further information and training re-certification requirements.

## **8.0 RELATED DOCUMENTS**

Not applicable

## **9.0 STANDARD REVIEW**

A subject matter expert (SME) will perform a technical review of this standard every two years to determine the accuracy of the content/information. The SME shall solicit input from applicable stakeholders to ensure the effectiveness of the standard. Any suggested changes must be reviewed and approved by the designated document owner.

## **10.0 REFERENCES**

S.A. 2020, c O-2.2 - Occupational Health and Safety Act

- 31 Right to refuse dangerous work

OSHA, Discrimination against Employees under OSHA Act of 1970, 1977.12

Canada Labour Code (CLC), Right to Refuse Dangerous Work, s. 122,128,129,146,147

## 11.0 APPENDIX

### 11.1 RIGHT TO REFUSE DANGEROUS WORK PROCESS FLOW

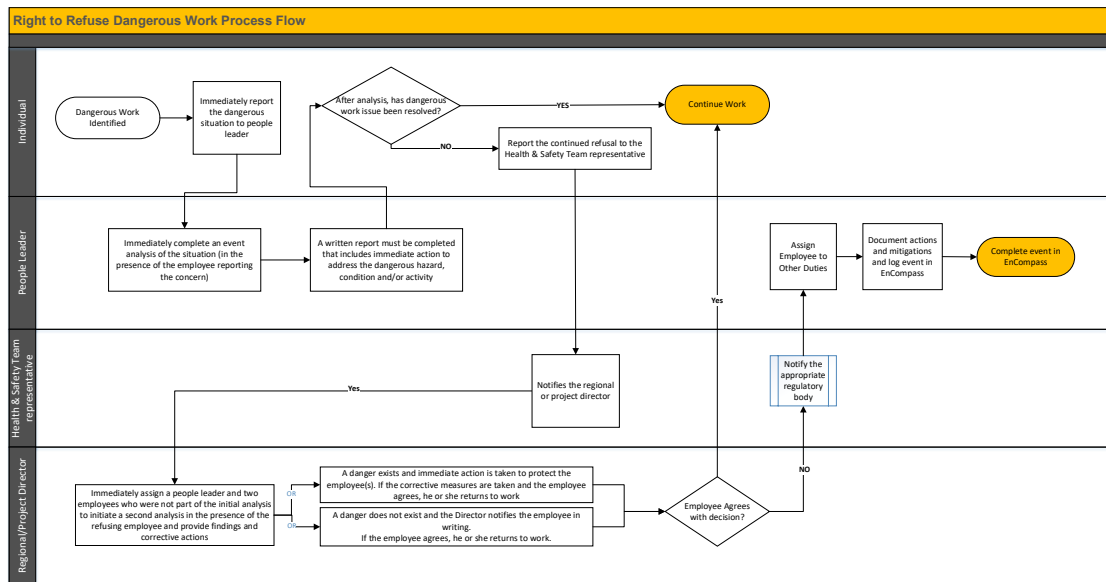



---

## CHANGE LOG

Section	Version 1.6	Version 1.7
Entire document		Clerical corrections including spelling, grammar, and document names.
3.0, 6.1, 6.2, 6.3, 6.4, 11.1		Updated terminology from incident and investigation to event and analysis.

<End of Document>



# Standard

---

## Safe Limits of Approach & Entry – Power Lines & Substations

---

**Effective Date:** 2019-03-30

**Version #:** 2.1

**Version Date:** 2024-03-27

---



**SAFE LIMITS OF APPROACH AND ENTRY  
- POWER LINES & SUBSTATIONS  
STANDARD**

Version #: 2.1  
Version Date: 2024-03-27



This page intentionally left blank

**SAFE LIMIT OF APPROACH AND ENTRY - POWER LINES & SUBSTATIONS  
STANDARD**

Version #: 2.1  
Version Date: 2024-03-27



Version Number	Version Date	Approved By	Section Number and Title	Details of Version
1.0	2019-03-30	Sean Evans	Whole Document (New Standard)	This is the new H&S standard that was developed as part of the LP   MP Safety Manual Transition Project
1.1	2019-10-31	Sean Evans	5.0, 6.0, 6.4	See change log
1.2	2020-06-01	Sean Evans	2.0, 5.0	Alignment with Contractor Safety Specifications
2.0	2021-06-01	Murray Evenson	1.0, 3.0, 6.0, 6.2, 9.0	See change log at end of this standard
2.1	2024-03-27	Troy Croft	All sections	Clerical corrections

Uncontrolled if Printed or Downloaded

Internal Information



This page intentionally left blank

---

## Table of Contents

1.0	Purpose .....	2
2.0	Scope .....	2
3.0	Prerequisites.....	2
4.0	Definitions & Acronyms .....	2
5.0	Roles & Responsibilities.....	5
6.0	General Requirements .....	6
6.1	Planning.....	7
6.2	Safe Limit of Approach Distances .....	9
6.2.1	Limited Approach Boundary .....	9
6.2.2	Restricted Approach Boundary.....	10
6.3	Overhead Power Lines .....	10
6.3.1	Equipment Hauling and Moving Under Overhead Power Lines.....	11
6.4	Signs & Barriers.....	13
6.5	Best Practices for High Risk Work.....	14
6.5.1	Heavy Mobile Equipment.....	14
6.5.2	Tree Trimming Work .....	14
6.5.3	Vehicles with Loads in Excess of a Height of 4.15 m (14 ft.) .....	15
6.6	Emergency Response Plan .....	15
6.7	Authorization to Access Substation – Non Electrical Workers .....	16
7.0	Training Requirements .....	17
8.0	Related Documents .....	17
9.0	Standard Review .....	17
10.0	References .....	17
	Change Log.....	18

## **1.0 PURPOSE**

The Safe Limits of Approach and Entry - Power Lines & Substations Standard provides employees and contractors with minimum requirements for planning and conducting non-electrical work activities in proximity to overhead power lines and associated infrastructure to eliminate the potential for contact. This standard also provides direction on safe entry into Substations for non-electrical workers. For electrical work tasks required to be completed within the safe limits of approach, reference the Electrical Safety Standard as described in section 6.2 of this document.

## **2.0 SCOPE**

This standard applies to LP Operations and Projects being completed for LP.

Contractors and subcontractors shall comply with Enbridge health and safety requirements set out in this standard, as articulated within applicable contractor safety specifications. If a contractor or subcontractor has a health and safety standard or policy materially different from Enbridge's, the contractor/subcontractor shall follow the most stringent requirement. Contractors and subcontractors are still obligated to meet the requirements of all applicable laws related to this Standard.

In the event a contractor's or subcontractor's standard exceeds the requirements of this standard, Enbridge may, in its sole discretion, choose to adopt the contractor's or subcontractor's standard for any given contract or work order.

## **3.0 PREREQUISITES**

Electrical Safety Standard

Ground Disturbance Standard

Hazard Assessment, Elimination & Control Standard

Inspections Standard

Safe Work Permit and Work Authorization Standard

Safety Meetings, Tailgates & Toolbox Talks Standard

Safety Observations Standard

## **4.0 DEFINITIONS & ACRONYMS**

*Danger Zone* - The area extending 6 meters / 20 feet around Mobile Equipment including attachments, implements and booms at furthest extension.

*Electric Utility Company* - An organization that supplies electricity to other consumers through an isolated generating unit, transmission facility or an electric distribution system.

*Electric Utility Representative* - A competent employee representing the electric utility company that is the owner/operator of the power line(s), who shall advise of the necessary Safe Limit of Approach distances and other required information respecting the overhead power line

*Electrical Work Tasks* – work activities with the intent to alter, operate, troubleshoot, install, or remove electrical components

*Electrical Work Zone* – an area where electrical work is being performed by a qualified electrical worker

*Energized* - Electrically connected to or having a source of voltage.

*Exposed* - (as applied to energized electrical conductors or circuit parts) Capable of being inadvertently touched or approached nearer than a safe distance by a person. It is applied to electrical conductors or circuit parts that are not suitably grounded, isolated, or insulated.

*Exposed Movable Conductor* - describes a condition in which the distance between the conductor and a person is not under the control of the person.

*High Voltage* – >750VAC for Canada or >600VAC for the United States.

*Inadvertent Movement Adder*- Precautionary distance added to the minimum flashover (air insulation) distance based on experience and precautions for inadvertent movement.

*Limits of Approach* – Minimum distances from exposed energized electrical conductors or circuit parts for workers to avoid exposure to electric shock due to flashover.

*Limited Approach Boundary, Shock* - An approach limit at a distance from an exposed energized electrical conductor or circuit part within which a shock hazard exists.

*Low Voltage* - <750VAC for Canada or <600VAC for the United States.

*Minimum Approach Distance (MAD)* – Minimum safe distances from exposed energized electrical conductors or circuit parts for workers to avoid exposure to electric shock due to flashover. They include dimensions that are added to a basic minimum air insulation distance.

*Mobile Equipment* - Operator-driven vehicles other than normal transport vehicles (e.g., cars, trucks) used to perform work at a worksite whether electric, gasoline, compressed natural gas, diesel, or propane powered. Includes but is not limited to tractor trailer units, forklift trucks, front-end loaders, tracked vehicles, cranes, dump trucks, etc.

*Non-Electrical Worker (NEW)* - One who does not meet the criteria of a Qualified Electrical Worker.

*Operator-in-Charge* - An individual that is knowledgeable and experienced in the operation of high voltage substations who has been assigned the responsibility for the operation of the electrical system. Has authority within their jurisdiction to approve or reject work performed on the electrical system. Is responsible for maintaining the requirements of the Interconnection Agreement if one is in place with other electrical systems.

*Qualified* - One who, by possession of a recognized degree, certificate, or professional standing, or who by knowledge, training and experience, has successfully demonstrated his ability to solve or resolve problems relating to the subject matter, the work, or the project

*Qualified Electrical Worker (QEW)* - One who has demonstrated skills and knowledge related to the construction, operation and maintenance of electrical equipment and installations. Depending on jurisdiction, may have to be a certified Journeyman Electrician.

*Qualified Operations Representative* - a people leader, supervisor or designate representing the company

*Qualified Spotter* - A worker whose explicit role is to observe a Qualified Person's interaction with electrical equipment and warn operators when they are about to encroach into the Limits of Approach or Minimum Approach Distance surrounding overhead or underground powerlines, assets and other electrical apparatuses.

*Restricted Approach Boundary, Shock* - An approach limit at a distance from an exposed energized electrical conductor or circuit part within which there is an increased likelihood of shock, due to electrical arc over combined with inadvertent movement, for personnel working in close proximity to the energized electrical conductor or circuit part.

*Safe Limit of Approach* - Threshold distance established in all directions around an overhead power line in which encroachment of any portion of equipment, loads, rigging, or attachments or the approach of personnel is prohibited. Unless otherwise established by an Electric Utility or Qualified Operations Representative, the minimum Safe Limit of Approach is 33ft. (10.0 m).

*Step Potential* – Is the step voltage between the feet of a person standing near an energized grounded object (e.g., overhead power line). It is equal to the difference in voltage, given by the voltage distribution curve, between two points at different distances from the electrode.

*Substation* – Shall mean an integrated unit consisting of one or more transformers, disconnecting means, overcurrent devices, and other associated equipment, each contained in a suitable enclosure designed and constructed to restrict access to live parts. There will also be exposed overhead systems that connect the electrical equipment to the transmission or distribution systems.

*Touch Potential* – Is the touch voltage between the energized object and the feet of a person in contact with the object. It is equal to the difference in voltage between the object and a point some distance away.

*Unique Pole Identifier* - Alphanumeric naming convention utilized by the utility company to identify the pole location.

*Utility Tree Trimmer* – A Qualified Worker who specializes in the maintenance and removal of trees and other vegetation to ensure the proper function of electrical overhead power lines and equipment without interference.

---

## **5.0 ROLES & RESPONSIBILITIES**

People Leaders shall:

- Ensure that employees, contractors, and subcontractors under their control are aware of and comply with this standard
- Ensure that all required resources to effectively implement this Standard are readily available
- Ensure that only qualified workers are designated to support the execution of this Standard as required
- Conduct formal and informal site inspections, spot checks and safety observations to verify the use of this Standard. Ensure workers are trained on their roles and responsibilities as outlined in this standard

Equipment Operators / Workers shall:

- Review the work scope, drawings, and hazard assessment to ensure potential site hazards are identified and addressed as required prior to beginning work.
- Operate the mobile equipment under the guidance of the designated Qualified Spotter and discontinue operation when anyone signals an emergency stop or when the Qualified Spotter is no longer visible
- Ensure the mobile equipment has a conspicuous warning decal regarding electrical contact displayed within the cab/at the controls
- Review with the Qualified Spotter the height, width and maximum reach of the mobile equipment
- Establish and maintain reliable communication with the Qualified Spotter
- Establish and verify with the Qualified Spotter recognizable hand signals that will be used during the work

Qualified Spotters shall:

- Know the height, width and maximum reach of the mobile equipment and the Safe Limit of Approach and will ensure that at no time is there a Safe Limit of Approach encroachment
- Establish and maintain reliable communication with the Equipment Operator
- Establish and verify with the Equipment Operator recognizable hand signals that will be used during the work
- Perform no other duties except to communicate with and direct the Equipment Operator and will only signal for one piece of mobile equipment at a time. Guidance for excavating or operating taglines will require a separate Qualified Spotter



- Be responsible for stopping work if Safe Limit of Approach distances are being encroached upon or unsafe conditions are identified
- Wear a high visibility vest, harness, markings or use other methods to distinguish them from other workers.

Contractor shall, as articulated within the applicable contractor safety specifications:

- Develop their own power line encroachment policies and procedures incorporating all applicable regulatory requirements and the requirements set out in this standard
- Ensure the requirements of this Standard are reflected within their Site Specific Safety Plan (SSSP) – Project requirement only
- Ensure workers are trained on their roles and responsibilities as outlined in this standard

Safety Team shall:

- Provide timely advice, support and assistance to People Leaders and contractors in the implementation of this standard
- Ensure that the work practices within this Standard meet or exceed the legislative requirements dictated by the jurisdiction the work is being completed in
- Continually monitor for compliance to the requirements of this Standard

Safety Shared Services shall:

- Be responsible for the maintenance and continuous improvement of this standard

## **6.0 GENERAL REQUIREMENTS**

Specific requirements related to Safe Limit of Approach and work practices within substations for non-electrical workers are mandated by Provincial, Federal, and State Occupational Health & Safety OH&S/OSHA Acts, Standards, Codes & Regulations. This Standard has implemented the most stringent requirements within the jurisdictions that Enbridge currently operates within. However, if work is to commence within a regulatory body that has a more stringent regulatory requirement then that legislation must be adhered to. Contact the Safety Team for clarification as required.

It is important that workers understand and acknowledge the presence of overhead power lines or buried cables prior to performing work in proximity to overhead power lines or excavation work that may put them in contact with energized conductors. It is critical that workers understand that working in proximity to energized overhead power lines or overhead systems in high voltage substations can produce a fatal shock hazard exposure or create an arcing fault and arc flash that may cause a burn injury. You do not have to make contact to be exposed. Your body and equipment you are using must stay outside the identified Limits of Approach. With this understanding it should be noted that all overhead power lines or overhead systems in high voltage substations should be considered energized unless otherwise directed. In general, if the line voltage is unknown, stay

away a minimum of 10 m or 33 feet and contact the Electric Utility Company for assistance where applicable or the Qualified Operations Representative

Prior to performing ground disturbance, it is imperative that checks are conducted to ensure buried facilities such as electrical or fibre-optic cables are clearly identified prior to work commencement. Review the Ground Disturbance Standard for further direction if applicable to the work being planned.

Before work begins, conduct a hazard assessment and examine the work area to identify hazards and to establish that the Safe Limit of Approach distances to overhead power lines and overhead systems in high voltage substations contained in Table 1 Section 6.2 and ensure the Limits of Approach are NOT encroached.

Contact the Electric Utility Company or Qualified Operations Representative to determine the operating voltage of the overhead power line and confirm the Safe Limit of Approach distances; also, request assistance from the Electric Utility Company or Qualified Operations Representative if the work must be performed at a distance that is less than those specified in Table 1 Section 6.2. In this situation have the Electric Utility Company or Qualified Operations Representative isolate or relocate the line if needed.

Work around overhead power lines or overhead systems in high voltage substations should only be done during daylight hours or with adequate artificial lighting. Poor visibility conditions (e.g., rain, snow, fog) may dictate modifications to the work and may preclude the continuation of work.

Overhead power lines or overhead systems in high voltage substations will be presumed to be energized unless the Electric Utility Company or Qualified Operations Representative confirms that the overhead power line has been, and continues to be, de-energized and visibly grounded at the worksite. Material will not be offloaded and stored under or in the vicinity of overhead power lines. Areas within marshalling yards, storage facilities or rights-of-way in proximity to overhead power lines or overhead systems in high voltage substations, which may inadvertently be utilized as storage, will be cordoned off and signage erected to warn of the hazard.

When taglines are utilized, they will be made of non-conducting material such as dry rope.

## **6.1 PLANNING**

Planning of work specific to addressing electrical hazards related to overhead power line or overhead systems in high voltage substations is a critical component to eliminating the potential for proximity or contacting an energized overhead power line or overhead systems in high voltage substations. Best practices for implementation prior to work execution include:

- Identify all overhead power lines or overhead systems in high voltage substations by reviewing drawings and conducting site visits and thorough site/area assessments prior to all work activity. This includes:
  - equipment offloading sites,
  - access routes to/from worksite,

- material storage areas, in addition to the actual worksite(s).
- Mark the locations of overhead power lines on plans and drawings as applicable.
- Notify Electric Utility Companies or Qualified Operations Representative (where applicable), allowing a minimum of 72 hours notice if the work will require mobile equipment to operate within the Safe Limit of Approach of an overhead power line or overhead systems in a high voltage substation. Longer lead time may be required if on-site support from the Electric Utility Company or Qualified Operations Representative is necessary. Obtain Electric Utility Company or Qualified Operations Representative advice for:
  - Confirming overhead power line voltage(s);
  - Confirming voltage(s) of overhead systems in high voltage substations;
  - Safe Limit of Approach distances (Note: 30 ft. (9 m) may be insufficient in some circumstances - advice from the Electric Utility Company or Qualified Operations Representative is critical);
  - Height of applicable overhead power lines (NOTE: actual height of overhead power lines may be less than the original installed height due to road improvements/grading, snow pack, line sag, etc.);
  - Procedures to obtain on-site Electric Utility or Qualified Operations Representative representation or actions, if necessary;
  - Presence of and disablement of Autoreclosers;
  - Unique Pole Identifier;
  - Full isolation and issuance of a Guarantee of Isolation.

If surveying services are to be utilized, task the survey contractor with determining and documenting the height of overhead power lines at the planned crossing locations. Height of crossing will be marked on survey stakes at the location of the crossing or other comparable means to ensure communication.

Resource requirements should be planned for in advance, and may include additional personnel, signage, non-conductive ropes and guard poles (“goalposts”), appropriate communication devices for use by the Qualified Spotter, and Electric Utility Company or Qualified Operations Representative.

Identify, document and communicate all hazards and the applicable hazard control measures. Ensure that a copy of the hazard assessment is on site. hazards may include:

- Equipment offloading and equipment and/or materials staging near overhead power lines or overhead systems in high voltage substations;
- Spoil piles;

- Open excavations;
- Dump trucks travelling with raised boxes;
- Crane booms;
- Trucks with over height loads;
- Pipelining heavy equipment;
- Poor visibility due to rain, snow or fog;
- Proximity to power poles and guy wires;
- Changes to work scope;
- Weather conditions like ice, extreme heat, etc. that may impact the powerlines

Signage and barriers are required if an overhead power line encroaches or travels parallel to the proposed worksite and potential exists for the Danger Zone of any Mobile Equipment to encroach on the Safe Limit of Approach.

Designate a Qualified Spotter(s) to guide the movement of equipment at any time potential exists for the Danger Zone of any Mobile Equipment to encroach on the Safe Limit of Approach of an overhead power line.

Assess crossing locations for terrain that may cause any Mobile Equipment or component to weave or bob increasing the likelihood of encroachment on the Safe Limit of Approach or contact with the overhead power line.

Note: Approach of any equipment within 10 ft. (3m) is prohibited under all circumstances.

## **6.2 SAFE LIMIT OF APPROACH DISTANCES**

Workers shall maintain the Safe Limit of Approach distances as outlined in Table 1. These distances apply to Workers as noted, including their work involving tools, vehicles or equipment. A Qualified Spotter shall ensure the minimum Safe Limit of Approach distances are maintained by all workers and equipment in the area. As part of this duty, the Qualified Spotter shall monitor movements of all workers, tools and equipment when work is in progress near energized overhead power lines or overhead systems in high voltage substations.

### **6.2.1 LIMITED APPROACH BOUNDARY**

Non-electrical workers must be accompanied by a qualified electrical worker when entering the limited approach boundary.

At no time shall Non-electrical workers be allowed to cross the Restricted Approach Boundary.

### 6.2.2 RESTRICTED APPROACH BOUNDARY

Only Qualified Electrical workers can cross the Limited Approach Boundary but shall not cross the Restricted Approach Boundary without following the process outlined below:

When Electrical Work Tasks are required to be completed within the Restricted Approach Boundary, by an Electric Utility Company or Qualified Electrical Worker, the Electrical Safety Standard should be referenced to ensure proper planning and coordination. When the Electrical Work Tasks are required to be completed on an energized system, the Energized Electrical Work process described in the Electrical Safety Standard shall be implemented.

All non-electrical work tasks must be performed in a de-energized state when the Restricted Approach Boundary cannot be maintained. Work with the Electric Utility Company or Qualified Operations Representative to ensure Safe Limits of Approach distances are maintained and isolation of the system is completed as required.

Safe Limits of Approach Boundaries (Table 1)			
Nominal System Voltage Range Phase-to-Phase	Limited Approach Boundary		Restricted Approach Boundary (includes Inadvertent Movement Adder)
	Exposed Movable Conductor	Exposed Fixed Circuit Part	
Less than 30 V (CAN)	Not Specified	Not Specified	Not Specified
Less than 50 V (US)	Not Specified	Not Specified	Not Specified
31 V - 150 V (CAN)	3.0 m (10 ft 0 in.)	1.0 m (3 ft 6 in.)	Avoid Contact
51 V - 150 V (US)	3.0 m (10 ft 0 in.)	1.0 m (3 ft 6 in.)	Avoid Contact
151 V - 750 V	3.0 m (10 ft 0 in.)	1.0 m (3 ft 6 in.)	0.3 m (1 ft 0 in.)
751 V - 15 kV	3.0 m (10 ft 0 in.)	1.5 m (5 ft 0 in.)	0.7 m (2 ft 2 in.)
15.1 kV - 36 kV	3.0 m (10 ft 0 in.)	1.8 m (6 ft 0 in.)	0.8 m (2 ft 9 in.)
36.1 kV - 46 kV	3.0 m (10 ft 0 in.)	2.5 m (8 ft 0 in.)	0.8 m (2 ft 9 in.)
46.1 kV - 72.5 kV	3.0 m (10 ft 0 in.)	2.5 m (8 ft 0 in.)	1.0 m (3 ft 6 in.)
72.6 kV - 121 kV	3.3 m (10 ft 8 in.)	2.5 m (8 ft 0 in.)	1.0 m (3 ft 6 in.)
138 kV - 145 kV	3.4 m (11 ft 0 in.)	3.0 m (10 ft 0 in.)	1.2 m (3 ft 10 in.)
161 kV - 169 kV	3.6 m (11 ft 8 in.)	3.6 m (11 ft 8 in.)	1.3 m (4 ft 3 in.)
230 kV - 242 kV	4.0 m (13 ft 0 in.)	4.0 m (13 ft 0 in.)	1.7 m (5 ft 8 in.)
345 kV - 362 kV	4.7 m (15 ft 4 in.)	4.7 m (15 ft 4 in.)	2.8 m (9 ft 2 in.)
500 kV - 550 kV	5.8 m (19 ft 0 in.)	5.8 m (19 ft 0 in.)	3.6 m (11 ft 8 in.)
765 kV - 800 kV	7.2 m (23 ft 9 in.)	7.2 m (23 ft 9 in.)	4.9 m (15 ft 11 in.)

### 6.3 OVERHEAD POWER LINES

Unqualified workers shall not place themselves or operate equipment within the Safe Limit of Approach distance of overhead power lines or overhead systems in high voltage substations.

---

For work within the 6 m (20 ft.) Danger Zone of the Safe Limit of Approach boundary of overhead powerlines (see Figure 1.0) follow these requirements:

- Site orientations, pre-job meetings, and daily tailgate meetings which discuss:
  - assessed Hazards, SWPs and location(s) of the overhead power lines;
  - identified Hazards and any control
  - measures or precautions, in accordance with the Hazard Assessment;
- A Qualified Spotter shall be used when Workers and/or equipment encroach inside the Danger Zone and are in proximity to the Safe Limit of Approach distance.
- Delivery truck operators shall be cautioned about any overhead power lines present, and a Qualified Spotter shall assist with loading or unloading operations (as appropriate, other vehicle operators shall be similarly cautioned, e.g., high vehicles);
- When carrying ladders, or other metal conductive tools, equipment or materials they shall always be lower than shoulder height of the worker;
- Delivery or other vehicles that have emptied their material (e.g., dump trucks) shall not be permitted to leave the work location until the boom, lift or box is down and safely secured;
- Vehicles with loads higher than 4.5 m (14 ft.) shall follow specific procedures developed by Enbridge or the contractor to maintain safe working clearances when in transit below overhead power lines (see section 12.3);
- Warning cones/goal posts shall be used as visible indicators of the 3 m (10 ft.) Limit of Approach. A safe work area shall be established before work commences. (See Figure 2)
- If overhead power line voltages are unknown the Electric Utility Company or Qualified Operations Representative shall determine the voltages and confirm the Safe Limit of Approach distance; until confirmed, a minimum of 10 m (33 ft.) shall be maintained
- When isolating third party electricity crossings ensure that verification of isolation is carried out by an Electrical Utility Company Qualified Electrical Worker.

### **6.3.1 EQUIPMENT HAULING AND MOVING UNDER OVERHEAD POWER LINES**

Before proceeding, the People Leader must determine the location, height and voltage of all overhead power lines that will be encountered when transporting, low bedding, moving, or operating any equipment around overhead power lines.

Never attempt to throw the binder straps over a load near overhead power lines as there is a potential to have an inadvertent contact with the energized overhead power line.

Ensure that the equipment being transported or operated, including any materials or trees being handled by a piece of equipment remains outside the Safe Limit of Approach and clear of all support guywires from the towers or poles.

Use a Qualified Spotter in areas where there is a likelihood of encroaching on the Safe Limit of Approach distances.

Telephone, and fiber optic cable lines do not have Safe Limit of Approach distances; however the use of a Qualified Spotter may be required in areas where the equipment or material being handled may come in contact with the telephone or fiber optic cables.

Where it is determined that the height of equipment on a lowbed will be within the Safe Limit of Approach distance, the equipment must be either:

- Off loaded to travel under the overhead power lines and then re-loaded, or
- Disassembled sufficiently to travel under the overhead power lines and then re-assembled

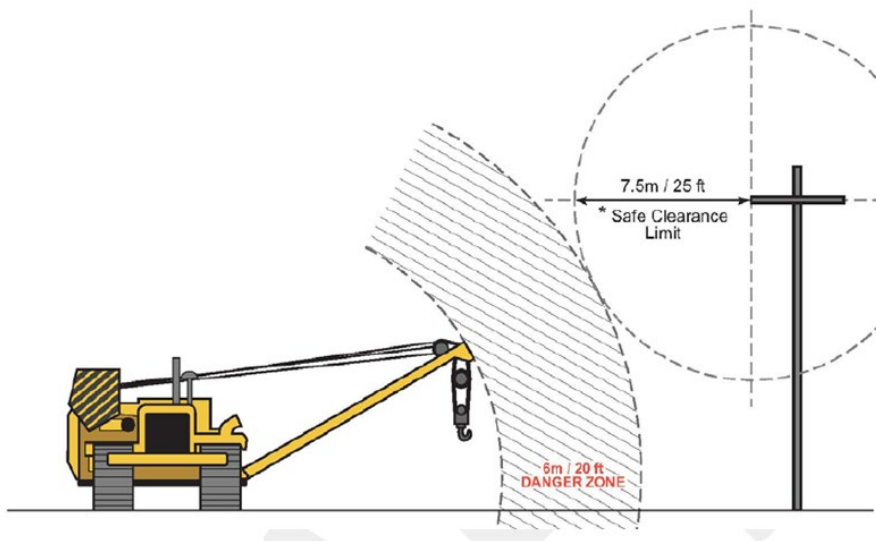

*Figure 1 Example of Danger Zone Between Equipment and Safe Limit of Approach Distance at known voltage of 300,000 – 350,000 Phase to Ground AC Voltage*



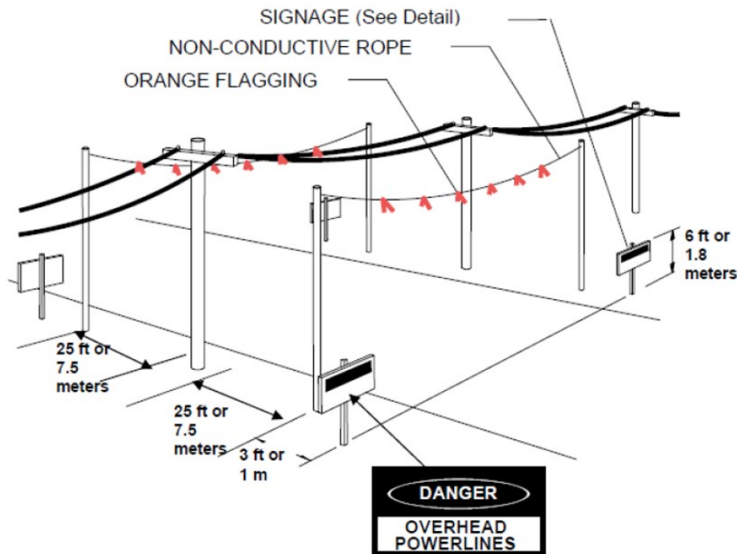

Figure 2 Crossing Overhead Power Lines

## 6.4 SIGNS & BARRIERS

Signs and barriers shall be installed by qualified workers prior to work commencing and shall remain in place until all work is completed. The condition and effectiveness of the signs and barriers must be documented as part of a daily inspection by a qualified worker each day that work is conducted around the overhead power lines.

Signage will consist of standard design warning signs at least 24" X 24" (60 cm X 60 cm) in size.

Place warning signs on each side of the overhead power lines in plain view of those travelling in either direction under or adjacent to the lines. The recommended height for visibility is 6 ft. (1.8 m). Warning signs should ideally be placed approximately 3 ft. (1m) outside the applicable Safe Limit of Approach, but in any event may not be placed inside the Safe Limit of Approach.

Non-conductive guard poles ("goalposts") connected by non-conductive rope are to be placed no closer to the overhead power line than the applicable Safe Limit of Approach. Metal guard poles ("goalposts") or guy wires ARE NOT permitted. Non-conductive polypropylene rope is recommended, and visibility shall be supplemented by attaching short pieces of surveyors ribbon intermittently along its length.

The following alerting techniques are used to warn and protect all persons from hazards that could cause injury or damage to health due to electric shock, and arc flash:

- Safety signs, safety symbols, or accident prevention tags are used where necessary to warn employees about electrical hazards that may endanger them;



- An Electrical Work Zone will be established with barricading which can include the use of red “Danger” tape that is tagged or an Qualified Spotter;
- Barricades are used in conjunction with safety signs where it is necessary to prevent or limit individual access to work areas where individuals may be exposed to energized electrical conductors or circuit parts. Conductive barricades may not be used where they might cause an electrical contact hazard;
- If signs and barricades do not provide sufficient warning and protection from electrical hazards, a Qualified Spotter is stationed to warn and protect employees from entering the area.

## **6.5 BEST PRACTICES FOR HIGH RISK WORK**

### **6.5.1 HEAVY MOBILE EQUIPMENT**

All workers in the vicinity of heavy equipment working near overhead power lines shall be instructed to remain clear and out of contact with the frame of the equipment, hoisting lines or hoisted load.

Machinery and equipment will not be parked, fuelled or serviced under or within the Safe Limit of Approach distance of overhead power lines.

Dump trucks and track hoes must not travel with a raised box/upright booms within the Safe Limit of Approach distance for overhead power lines.

Independent truck drivers delivering materials to field locations shall be cautioned about overhead power lines before beginning work, and a properly trained on-site or contractor worker shall assist in the loading or off-loading operation. Vehicles that have emptied their material shall not leave the work location until the boom, lift, or box is down and safely secured.

### **6.5.2 TREE TRIMMING WORK**

Overhead power lines shall be treated as energized and operating at high voltage until de-energized and verified zero voltage by the Qualified Electrical Worker or an Electric Utility Company Representative. A Utility Tree Trimmer shall be employed to remove trees and tree limbs in the vicinity of overhead power lines. Any part of the tree in contact with the overhead power line is to be considered energized at the full voltage of the overhead power line to which it is contacted.

A tree located within 1.5 times its height from Safe Limit of Approach distance will be felled mechanically or using mechanical assists only. No conventional hand falling is to take place within this perimeter. In circumstances where the terrain or conditions will not permit the use of a machine or machine assist, specialized fallers or certified Utility Tree Trimmers may be required. Specialized

falling techniques with the use of tree jacks and or lines or other specialized falling practices may be utilized.

### **6.5.3 VEHICLES WITH LOADS IN EXCESS OF A HEIGHT OF 4.15 M (14 FT.)**

All vehicles with loads in excess of 4.15 meters (14 ft.) must use specific procedures to maintain safe working clearances when in transit below overhead power lines.

The specific procedures for moving loads in excess of 4.15 m (14 ft.) or via routes with lower overhead power line clearance heights are as follows:

- Prior to movement of any load in excess of 4.15 m (14 ft.), the Operator-in-Charge and/or the Electrical Utility Representative shall be notified of the equipment move. Travel on Provincial or State roads or highways shall be approved by the authority having jurisdiction;
- A Qualified Electrical Worker shall check the intended route to the next location before relocation;
- The new site shall be checked for overhead power lines and clearances;
- Overhead power lines and telephone or fibre optic cables shall be identified and extreme care used when travelling beneath the overhead power lines;
- The company moving the load or equipment shall provide a driver responsible for measuring each load and ensuring that each load is secured and transported in a safe manner;
- Overhead power line clearances shall be planned and safely measured by an Electric Utility Company or Qualified Operations Representative before high loads are transported.

If Safe Limit of Approach cannot be maintained, the job shall be shut down until a safe route can be established or the necessary repairs or relocations have been completed to ensure that a safe working clearance has been achieved.

## **6.6 EMERGENCY RESPONSE PLAN**

If an overhead power line falls or is contacted, the following requirements shall be observed:

1. Keep everyone at least 30m (100 ft.) away.
2. Follow all requirements of Enbridge Pipelines LP Emergency Response Program. Call the Operator-in-Charge and/or Electrical Utility Representative immediately.
3. Use red "Danger" tape and other barricades to ensure vehicle traffic cannot encroach on the fallen or low wires.
4. Do not attempt to move the wire(s).
5. Do not touch anything that is touching the wire(s).

6. Be alert to the presence of water or other conductors.
7. If an individual becomes energized, do not touch the individual or anything in contact with him or her. Rescue of the victim shall be undertaken when all hazards have been removed and verified by an Electric Utility Company or Qualified Operations Representative.
8. If energized conductors contact a vehicle, turn off the vehicle and remain in the vehicle and wait for rescue. If it becomes necessary to exit the vehicle due to smoke, fire, or other hazard, jump clear of the vehicle without touching it at the same time, maintain your balance, keep your feet together, and shuffle or bunny hop away from the vehicle 10 m (33 ft.) or more. Do not return to the vehicle or allow anyone else to return to the vehicle for any reason until the Electric Utility Company or Qualified Operations Representative has removed the overhead power line from the vehicle and has confirmed that the vehicle is no longer in contact with the overhead power lines.
9. Quarantine for 48 hours rubber-tired vehicles that have contacted energized lines (to address the hazard of tire pyrolysis).

## **6.7 AUTHORIZATION TO ACCESS SUBSTATION – NON ELECTRICAL WORKERS**

Before granting access to a high voltage substation, the Qualified Electrical Worker High Voltage requires a Field Level Hazard Assessment (FLHA). The following general rules and policies apply with respect to access to the high voltage Substation:

- Prohibited material, tools and equipment shall not be taken into the Substation;
- Inventory all materials, PPE, tools and equipment that will be taken into the Substation and utilized during the work task that will be executed. Upon completion of the work task all materials, PPE, tools and equipment must be confirmed as removed from the Substation using the inventoried list;
- Under “Normal Operating Conditions” the minimum PPE required to be worn when entering high voltage substations includes daily FR workwear (pants/shirts and/or coveralls), hard hats, safety glasses with side shields, gloves, and protective footwear rated for electrical. An increased level of PPE may be required to be worn as determined for the work activity taking place in the substation and applicable arc flash hazard labels. PPE requirements for electrical work activities performed by qualified electrical workers are outlined in the Electrical Safety Standard.
- Qualified Electrical Workers High Voltage are authorized to enter the Substation. Any other worker shall be escorted and supervised at all times by the authorized Qualified Electrical Worker High Voltage;

When maintenance work tasks are required inside the Substation that are not energized work tasks, but relate to snow removal or over growth management or other similar non-electrical maintenance tasks (e.g. painting) a Qualified Electrical Worker High Voltage must instruct the Non-Electrical Workers on the Safe Limit of Approach and will directly supervise the work as it is completed;

- Do NOT use metal ladders, wooden ladders, metal measuring tapes, ropes, hand lines, metal hard hats or similar equipment constructed of metal, or with metal strands in the fabric. This equipment is PROHIBITED from entering the Substation;
- Arms are to be kept below shoulder level when working around energized Substation equipment;
- Look up and check the equipment before you start to work around it. Check for broken risers, broken porcelain or anything that is in an abnormal condition.

## **7.0 TRAINING REQUIREMENTS**

Personnel working in the field must be knowledgeable in this Standard and may be assigned applicable training as driven by the Safety Training Matrix.

Reference the Health & Safety training syllabi and matrices for further information and training re-certification requirements.

## **8.0 RELATED DOCUMENTS**

Not applicable

## **9.0 STANDARD REVIEW**

A subject matter expert (SME) will perform a technical review of this standard every two years to determine the accuracy of the content/information. The SME shall solicit input from applicable stakeholders to ensure the effectiveness of the standard. Any suggested changes must be reviewed and approved by the designated document owner.

## **10.0 REFERENCES**

CAN/ULC S801

Canada Labour Code, Part II:

- Canadian Occupational Safety & Health (COSH) regulations

CSA Z462 Workplace Electrical Safety Standard

- Electrical Safety, 8.8 Safety Watch
- Electrical, Safeguards for personal protection, 29 CFR 1910.335 Subpart S
- Hazard Assessment and Prevention Program, 11.2, 19.1

IEEE C2, National Electrical Safety Code (NESC)

NFPA 70E Standard for Electrical Safety in the Workplace

Occupational Safety and Health Administration (OSHA):

- Overhead Line, CFR 1926.955 – Overhead Lines

- Specifications for accident prevention signs & tags, 29 CFR 1910.145

## **CHANGE LOG**

<b>Section</b>	<b>Version 2.0</b>	<b>Version 2.1</b>
Entire document		Clerical corrections including spelling, grammar, and document names.

<End of Document>



---

# Standard

---

## Safe Work Permit & Work Authorization

---

**Effective Date:** 2019-03-30  
**Version #:** 1.4  
**Version Date:** 2024-03-28

---

This page intentionally left blank







---

This page intentionally left blank

---

## Table of Contents

1.0	Purpose .....	3
2.0	Scope .....	3
3.0	Prerequisites.....	4
4.0	Definitions and Acronyms.....	4
5.0	Roles & Responsibilities.....	5
6.0	General Requirements .....	8
6.1.	Safe Work Permit Requirements .....	8
6.1.1	Safe Work Permit General Requirements .....	8
6.1.2	Work requiring Safe Work Permit .....	8
6.1.3	Exemptions for Long Term Operations Contractor Personnel .....	9
6.1.4	Duration .....	10
6.1.5	Mobile Crews without Enbridge Inspector .....	11
6.1.6	Transfer of Responsibility .....	11
6.1.7	Document Copies .....	11
6.2.	Work Authorization Requirements.....	12
6.2.1	Work Authorization General Requirements .....	12
6.2.2	Duration .....	12
6.2.3	Document Copies .....	13
6.3.	Suspension of Work Authorization and Safe Work Permits .....	13
6.4.	Spot Checks using SWP/Hazard Assessment Review Checklist .....	13



---

7.0	Training.....	14
8.0	Related Documents.....	14
9.0	Standard Review.....	14
10.0	References.....	14
11.0	Appendix.....	15
	Appendix A: Safe Work Permit Process.....	15
	Appendix B: Safe Work Permit.....	16
	Appendix C: Work Authorization Form.....	17
	Change Log.....	18

---

## 1.0 PURPOSE

The purpose of this standard is to ensure that Enbridge workforce and contractors use a consistent approach for authorizing work using the Safe Work Permit and/or Work Authorization Process.

The purpose of a *Safe Work Permit* (SWP) is to ensure there is a conversation between the Person in Charge of the Enbridge work area and any worker(s) performing work in the area so that:

- The hazards presented by the operation do not harm the worker(s);
- The work performed by the worker(s) does not harm the operation; and
- Both the Person in Charge of the operational area and the worker are clear regarding:
  - What work is authorized;
  - When work is authorized to begin and when it must end;
  - Where (and on what equipment) the work is to be conducted; and
  - Any conditions and restrictions under which the work must be conducted.

The *Work Authorization Process* provides a formal way to acknowledge an extended work plan for contractors on an Enbridge site and documents who (and how) safe work permitting duties will be managed in the course of that work.

In practice, a work authorization is primarily used for work or a project that:

- Is conducted by a contractor;
- Will take an extended period of time (weeks or months vs days); and
- Is under the direction of an Enbridge Inspector to issue daily SWPs (rather than a Person in Charge within the local area).

## 2.0 SCOPE

This standard applies to LP Operations and Projects being completed for LP.

Safe Work Permits (SWP) and Work Authorizations (WA) should not be regarded as a statement that all hazards and risks have been eliminated from the work area. The issuing of such a document does not, by itself, make a job safe. That can be achieved only by those preparing for the work and those carrying it out.

Contractors and subcontractors shall comply with Enbridge health and safety requirements set out in this standard, as articulated within applicable contractor safety specifications.

If a contractor or subcontractor has a health and safety standard or policy materially different from Enbridge's, the contractor/subcontractor shall follow the most stringent requirement. Contractors and subcontractors are still obligated to meet the requirements of all applicable laws related to this standard.

In the event a contractor's or subcontractor's standard exceeds the requirements of this standard, Enbridge may, in its sole discretion, choose to adopt the contractor's or subcontractor's standard for any given contract or work order.

### **3.0 PREREQUISITES**

Atmospheric Monitoring Standard

Confined Space Entry Standard – Canada/ US

Ground Disturbance Standard

Hazard Assessment & Control Standard

Hot Work & Ignition Sources Standard

### **4.0 DEFINITIONS AND ACRONYMS**

*Field Level Hazard Assessment (FLHA)* - a hazard assessment completed at the work face that assesses the hazards associated with the environmental conditions, nearby work, small tasks or hazards that could not be identified during the planning stages of jobs.

*Hazard* - anything with sufficient energy, or potential energy, that can cause harm.

*Hazardous Area* - an area in which there is significant potential for a flammable or toxic atmosphere to be present or develop.

*Person in Charge* - the employee or contractor responsible for the project or the scope of work who has current permit training.

*Procedure* - A step-by-step description of how to proceed, from start to finish, in performing a task properly.

*Qualified* - one who, by possession of a recognized degree, certificate, or professional standing, or who by knowledge, training and experience, has successfully demonstrated their ability to solve or resolve problems relating to the subject matter, the work, or the project.

*Restricted Area* - any area in which there is limited potential for a flammable or toxic atmosphere to develop.

*ROW – Right of Way*

*Safe Work Permit (SWP)* - agreement between the Safe Work Permit Issuer and Safe Work Permit Receiver on the hazards associated with the job have been identified and controlled.

*Safe Work Permit Issuer* - a qualified person that has been trained in the Safe Work Permit and is competent in understanding the hazards associated with the area or facility in which work is to take place.

*Safe Work Permit Receiver* - person accepting responsibility for the work being conducted.

*Site Safety Plot Plan* - site-specific drawing that shows Hazardous and Restricted Areas, primary evacuation site, secondary evacuation site, helicopter landing areas and the location of safety facilities and equipment (e.g., evacuation alarms, wind socks, fire extinguishers and first aid stations).

*Work Authorization (WA)* - the Work Authorization process provides a formal process to acknowledge an extended work plan for Contractors on an Enbridge site and documents who (and how) Safe Work Permitting duties will be managed during that work.

*Work Authorization Issuer* - a qualified person that has been trained in the SWP & WA and is competent in understanding the hazards associated with the area or facility in which work is to take place.

## **5.0 ROLES & RESPONSIBILITIES**

Regional and project management is responsible for ensuring:

- Safe Work Permit (SWP) and Work Authorization (WA) Issuers are qualified to issue SWPs and WAs;
- SWP training is made available and completed by workers who will be issuing SWPs or WAs;
- SWP and WA spot check process is implemented in the workplace;
- Opportunities for improvement are identified, reviewed and implemented for continuous development of the SWP and WA process;
- SWPs and WAs are documented and retained as required; and
- Documented spot checks are completed by people leaders.

People Leader shall:

- Verify, through audit, direct observation, and spot checks using the *SWP/Hazard Assessment Review Checklist Form* that the SWP and WA process is used in the workplace and is in compliance with this standard;
- Ensure appropriate use of SWPs and WAs;
- Ensure, through periodic review, that SWP Issuers are adequately trained in the SWP and WA process and tools given the scope of the work;
- Identify opportunities for improvement of the process and communicating them to management; and
- Communicate all active WAs to the respective Area or Project Manager.

### **Safe Work Permit Issuer**

The SWP Issuer shall be familiar with the worksite and the site specific hazards covered by the SWP being issued.

The SWP Permit Issuer is responsible for:

- Completing SWP training;
- Specifying the work to be carried out and the location of the work in cooperation with the SWP Receiver;
- Identifying and discussing site specific hazards with the SWP Receiver;
- Determining if the work being performed may impact operations;
- Conducting a worksite visit with SWP Receiver if job scope requires a visit;
- Ensuring SWP is correctly completed;
- Conducting or having an Enbridge representative perform initial atmospheric monitoring (when required) and documenting the results on the SWP;
- Verifying the SWP Receiver understands the conditions of the SWP;
- Suspending and revalidating work as required;
- Conducting periodic general inspections of the job site to confirm adherence to SWP; and
- Informing SWP Receiver of changes that could impact their work (including if the SWP Issuer is transferring their responsibility to another Issuer).

### **Safe Work Permit Receiver**

The SWP Receiver shall be familiar with the SWP process, the work area, equipment, and understand the work to be carried out. This can occur as part of the worksite visit.

The SWP Receiver is responsible for:

- Reviewing and agreeing to the conditions of the SWP;
- Communicating the SWP requirements to all workers involved in the work;
- Ensuring the SWP requirements are fulfilled by all workers during the work;
- Keeping a copy of the SWP (white/top copy) readily available at the work location;
- Suspending work as required;
- Having suspended work revalidated by SWP Issuer before recommencing work;
- Ensuring Field Level Hazard Assessments (FLHA) are completed and reviewed for the work and that workers involved in the work participated in the FLHA;

- Informing SWP Issuer of a transfer of responsibility to determine if a new SWP is required;
- Returning the equipment, process or area to a safe condition before returning the SWP and FLHAs back to the SWP Issuer; and
- Ensuring SWP is completed and signed-off when returned to the SWP Issuer.

### **Work Authorization Issuer**

The WA Issuer is responsible for:

- Successfully completing the SWP training;
- Specifying the work to be carried out and the location of the work in cooperation with the Enbridge inspector;
- Communicating any operational or atmospheric monitoring requirements as well as any site specific Hazards to the Enbridge inspector;
- Determining if the work being performed may impact operations;
- Verifying the Enbridge inspector understands the conditions of the WA;
- Establishing the frequency of contact with the Enbridge inspector;
- Authorizing the Enbridge inspector to issue SWPs for the work indicated on the WA;
- Suspending and revalidating WA as required; and
- Communicating to the respective Area or Project Manager all active WAs.

### **Enbridge Inspectors**

The Enbridge inspector's responsibilities include those expected of the SWP Issuer as well as being responsible for:

- Reviewing scope of work and location of work with WA Issuer;
- Identifying to the WA Issuer the other Enbridge inspectors who will be issuing SWPs on a job;
- Ensuring other Enbridge inspectors authorized to issue SWPs on a job are aware of and agree to the WA details;
- Ensuring the WA agreement is adhered to for the duration of the job; and
- Issuing SWPs to the working group(s).



---

## **6.0 GENERAL REQUIREMENTS**

### **6.1. SAFE WORK PERMIT REQUIREMENTS**

#### **6.1.1 SAFE WORK PERMIT GENERAL REQUIREMENTS**

- SWP may be issued verbally, electronically or in person;
- SWP Issuers cannot issue permits to themselves. In instances of remote work, the SWP can be issued verbally or electronically:
  - Remote workers can capture verbal requirements on their own copy of SWP, logging date and time of approval by Issuer on the SWP. Electronic follow up for verification is preferred.
- SWP cannot be issued directly to a subcontractor;
- As practical, based on job scope and location, the SWP Issuer shall visit the worksite with the SWP Receiver to identify hazards of the work location;
- All workers shall be made aware of and adhere to the conditions of the SWP;
- The working group shall complete an FLHA prior to commencing work;
- Only the work stipulated on the SWP in the identified location is to be performed;
- When initial atmospheric monitoring is required, it shall be conducted and documented on the SWP before work can begin. Also:
  - Subsequent atmospheric monitoring shall be completed as indicated on the SWP, use the *Atmospheric Monitoring Standard* for guidance on frequency of testing; and
  - Initial atmospheric monitoring is an Enbridge responsibility and shall be completed or witnessed by an operations representative, Enbridge inspector or another Enbridge representative. This initial testing shall be documented on the SWP. Subsequent atmospheric monitoring can be performed by the person responsible for the work and may be verified by Enbridge.
- Enbridge inspectors issuing SWPs shall receive a valid Work Authorization prior to issuing any SWPs.

#### **6.1.2 WORK REQUIRING SAFE WORK PERMIT**

The following types of work require an SWP:

- Work where the shutdown and/or isolation of equipment and/or processes are required to complete the work; except where Simple Lockout is used (see Control of Hazardous Energy Standard)

- Work on electrical equipment and circuits with voltages >750V (CAN) or >600V (USA);
- Work that requires entry into a confined space (*Confined Space Permit* requirements are set out in the *Confined Space Entry Standard*);
- Work upstream of the 480V main breaker;
- Looking for and work on pipeline anomalies;
- Work on leaks or leak sites;
- Welding on mainline or station piping;
- Work involving contractors (apart from exceptions managed as per below);
- Hot work in Hazardous or Restricted Areas with the following exceptions for Employees and Long Term Contractors:
  - Breaking low voltage connections in Restricted Areas
  - Work that involves using low voltage equipment such as voltmeters, laser alignment and hand-held vibration meters, analyzers, cellular telephones or cameras with the use of Personal Gas Monitors
- Work on or around an open system with the following exceptions:
  - Flushing units;
  - Gauging;
  - Sampling; and
  - Opening depressurized lines less than or equal to 2 inches in diameter.
- Contractors may be exempt from safe work permitting for the following:
  - Driving vehicles through Restricted Areas;
  - Delivery and service personnel (e.g., delivery and supply vendors, equipment service personnel, telephone, computer, etc.); and
  - Long term operations contractor personnel.

Contractor exemptions shall be approved by the person responsible for the location, and work shall be monitored by an Enbridge operations employee or designate.

### **6.1.3 EXEMPTIONS FOR LONG TERM OPERATIONS CONTRACTOR PERSONNEL**

Long term operations contractor personnel may be given an exemption for a SWP for up to one year if all the following requirements are met. They:

- Are approved by the operations employee responsible for the contractor and operations management or the person responsible for the work location(s);

- Have been used on a frequent basis or have worked extended periods of time with Enbridge;
- Clearly demonstrate their knowledge and understanding of safe work practices and technical Procedures applicable to their line of work;
- Have been given a thorough safety orientation;
- Participate in Enbridge safety meetings as determined by the person responsible for the site;
- Maintain daily communication with Enbridge operations representative or designate; and
- Are monitored by the Enbridge operations representative or designate responsible for the location and work.

The Enbridge operations representative responsible for a contractor shall document an exemption on the Long Term Operations Contractor Personnel Exemption Form, and provide copies to the contractor, operations management, and employee(s) responsible for the location(s).

Documentation shall include:

- A brief description of the services being provided (e.g., welding, electrical, mechanical labor, inspection services, cathodic protection system maintenance);
- Justification for the exemption;
- Names of contractor and subcontractor personnel;
- Special requirements;
- Locations for which the exemption applies (e.g., station, ROW milepost boundaries);
- Period of time for which the exemption applies; and
- Name of Enbridge employee who approved the exemption.

Long term operations contractor personnel provided an exemption shall comply with all stipulated requirements as listed in 6.1.1 and 6.1.2.

#### **6.1.4 DURATION**

- A SWP is only valid for the time stated on the permit to a maximum of 12 hours except for mobile crews without an Enbridge Inspector;
- A SWP may be extended an additional 12 hours to a maximum of 24 hours provided that:
  - The work is continuous;

- The workers do not exceed the maximum allowable hours worked;
- A review of the SWP indicates it is still valid;
- All workers understand the requirements of the SWP and meet FLHA requirements;
- An extension is identified and authorized on the SWP as required; and
- Transfer of responsibility is completed as required.

### **6.1.5 MOBILE CREWS WITHOUT ENBRIDGE INSPECTOR**

Mobile crews are contractor crews that are required to perform a specific job function over a specified span of ROW or at multiple facilities without direct oversight by an Enbridge representative (e.g., pig trackers, cathodic protection, surveyors, vegetation control),

Mobile crews may be issued a SWP at the originating location of the work for the duration of the job provided that:

- A frequency of contact is established and implemented (this frequency of contact is the minimum requirement of how often the SWP Receiver shall contact the SWP Issuer. The SWP Receiver documents this communication under the “Frequency of Contact with Issuer or Designate” section on the SWP; additional documentation may be attached to the SWP should space not be available); and
- A new FLHA is completed at the beginning of each day or shift and updated as required.

### **6.1.6 TRANSFER OF RESPONSIBILITY**

Any changes to the responsible parties during the course of the work shall be documented on the SWP as a transfer of responsibility: A SWP can only be transferred once and require the following:

- The SWP Issuer, Receiver and all workers affected shall be made aware of any transfers of responsibilities.
- The SWP Issuer reserves the right to suspend the current SWP and require a new SWP to be issued.

### **6.1.7 DOCUMENT COPIES**

- White/top copy: SWP Receiver keeps or posts this copy at the work location while the permit is valid. SWP Receiver returns this copy, FLHA and other pertinent documentation to the SWP Issuer when the SWP time period has expired.

If an event occurs during the course of work, the white copy of the SWP along with all other documentation shall be forwarded to the person responsible for conducting the

event analysis and will be retained as identified in the requirements for event analysis documentation.

- Yellow copy: SWP Issuer posts this copy at the worksite or similar site locality to identify work activities occurring at the site. Discard after the white copy is returned or give to the SWP Receiver if requested.

In compliance with *Enbridge's Records Management Policy and Records Retention Schedule*, Enbridge Employees must retain all SWPs and any related documents or records. Contractors shall have a records retention policy to ensure that all documents or records used, prepared or produced by the contractor in the performance of the work are maintained by the contractor for durations of time that are not less than the limitation periods prescribed in the applicable statutes of limitations or limitation of actions legislation in force in the jurisdictions the contractor operates.

## **6.2. WORK AUTHORIZATION REQUIREMENTS**

### **6.2.1 WORK AUTHORIZATION GENERAL REQUIREMENTS**

The requirement for a WA is a regional determination by operations management for new construction on greenfield worksites.

Receiving a WA authorizes an Enbridge inspector to issue SWP(s) to the working group(s) for the scope of work in the location identified on the WA.

WA is required for all Enbridge inspectors issuing SWPs and third party facility owners/ operators working on Enbridge owned property or Enbridge ROW

- If the job has multiple Enbridge inspectors, the names of all of the Enbridge inspectors authorized to issue SWPs shall be written on the applicable WA form.

### **6.2.2 DURATION**

WAs may be issued to cover multiple shifts or days if the job conditions and scope of work remain the same.

In this case, the general practice is:

- A single WA form is issued to the Enbridge inspector for the duration of the job.
  - The WA Issuer and Receiver shall agree upon a reasonable frequency of contact. This frequency of contact is the minimum requirement of how often the receiver of the WA shall contact the WA Issuer.
  - The receiver of the WA documents this communication under the "Frequency of Contact with Issuer or Designate" section on the WA.
  - Additional documentation may be attached to the form should space not be available.

- The Enbridge inspector issues SWPs as per the SWP duration requirements.

### **6.2.3 DOCUMENT COPIES**

- White/top copy: Enbridge inspector keeps or posts this copy at the work location while the WA is valid. Inspector returns this copy to the WA Issuer when the WA is no longer valid.

If an event occurs during the course of work, the white copy of the WA along with all other pertinent documentation shall be forwarded to the person responsible for the analysis and will be retained as identified in the requirements for event analysis documentation.

- Yellow copy: WA Issuer posts this copy at the worksite or similar site locality to identify work activities occurring at the site. Discard after the white copy is returned or give it to the Inspector if requested.

### **6.3. SUSPENSION OF WORK AUTHORIZATION AND SAFE WORK PERMITS**

The WA and/or SWP become suspended and work shall stop under any of the following conditions:

- Site emergencies;
- Scope of work changes; and/or
- Requested to stop work.

The time of suspension shall be documented on the WA or SWP, as the case may be, by the Receiver. Suspended permits shall be revalidated, at a minimum, verbally by the Issuer and documented on the WA or SWP before work can resume.

Suspensions due to scope of work changes cannot be revalidated. A new WA and/or SWP is required.

### **6.4. SPOT CHECKS USING SWP/HAZARD ASSESSMENT REVIEW CHECKLIST**

To ensure completed SWPs and WA Forms are meeting standards and to improve quality, people leaders must complete and document spot checks using the *OMM-B2-S-001 SWP/Hazard Assessment Review Checklist Form* for each of the following (as available):

- A minimum of one SWP; and
- A minimum of one WA Form.

Spot checks should be completed on a monthly basis.

During verification activities, if an isolation point is found to be tagged or labeled incorrectly or the tag/label is missing, any work taking place shall be stopped until the tag or label is corrected or replaced. Refer to section '6.6 – Lockout/Tagout Assurance Process for Asset Management' in the Control of Hazardous Energy Safety Standard.

---

## **7.0 TRAINING**

Workers who have been assigned the responsibility of: WA Issuer; SWP Issuer, and/or Enbridge inspector within their job role will be required to take SWP training.

Reference the *Health & Safety Training Syllabi* and matrices for further information and training re-certification requirements.

## **8.0 RELATED DOCUMENTS**

Ground Disturbance Standard

Hazard Assessment & Control Standard

Record Retention Policy

Safe Work Permit Form

Work Authorization Form

Long Term Operations Contractor Personnel Exemption Form

## **9.0 STANDARD REVIEW**

This standard shall be reviewed by a designated owner annually and a technical review committee every two years.

Technical reviews shall solicit input from non-managerial field employees to ensure the effectiveness of the standard.

## **10.0 REFERENCES**

Occupational Safety and Health Administration (OSHA):

- Hazard Communication, 29 CFR 1910.1200.

Canada Labour Code, Part II – Occupational Health & Safety:

- 124 Duties of Employers,
- 126 Duties of Employees,
- 135 Work Place Health & Safety Committees,
- 136 Health & Safety Representatives.

Canadian Occupational Health & Safety (COHS) regulations:

- Part XIX Hazard Prevention Program.

## 11.0 APPENDIX

### APPENDIX A: SAFE WORK PERMIT PROCESS

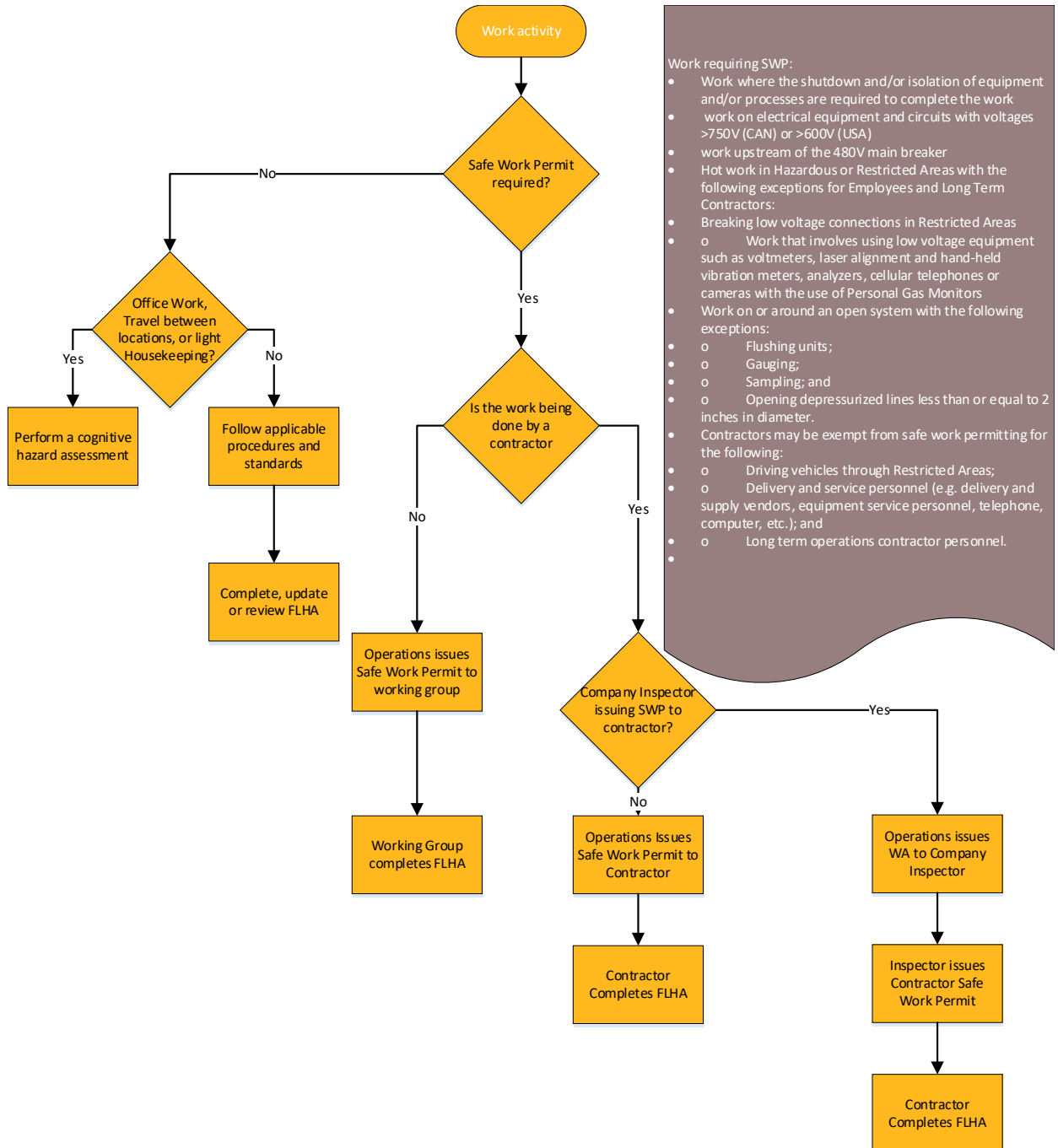





**APPENDIX B: SAFE WORK PERMIT**

**Safe Work Permit**



Part A: Work Details																																																	
Work Type: <input type="checkbox"/> Hot <input type="checkbox"/> Cold		Emergency Contact: _____ (Name) (Ph #) _____			Date/Time Issued: _____ MM/DD/YY _____ Time																																												
Work Environment: <input type="checkbox"/> Hazardous <input type="checkbox"/> Restricted <input type="checkbox"/> Unclassified		Alternate: _____ (Name) (Ph #) _____			Date/Time Expired: _____ MM/DD/YY _____ Time																																												
		Fire/Police/Ambulance: _____ Emergency Assembly Area: _____			Permit Extended (new expiry): _____ MM/DD/YY _____ Time																																												
Location: <i>Physical address, geographical description</i>					Extension Authorized by: _____ Permit Issuer or Designate																																												
					Suspended at: _____ MM/DD/YY _____ Time Permit Receiver Initials																																												
Work Scope/Description					Revalidated at: _____ MM/DD/YY _____ Time Permit Issuer Initials																																												
					Work Authorization Form # (if applicable)																																												
					Frequency of Contact with Permit Issuer or Designate: <input type="checkbox"/> Not applicable <input type="checkbox"/> Daily <input type="checkbox"/> Weekly <input type="checkbox"/> Other: _____																																												
					<table border="1"> <thead> <tr> <th>Date</th><th>Initial</th><th>Date</th><th>Initial</th><th>Date</th><th>Initial</th><th>Date</th><th>Initial</th><th>Date</th><th>Initial</th></tr> </thead> <tbody> <tr> <td> </td><td> </td><td> </td><td> </td><td> </td><td> </td><td> </td><td> </td><td> </td><td> </td></tr> <tr> <td> </td><td> </td><td> </td><td> </td><td> </td><td> </td><td> </td><td> </td><td> </td><td> </td></tr> <tr> <td> </td><td> </td><td> </td><td> </td><td> </td><td> </td><td> </td><td> </td><td> </td><td> </td></tr> </tbody> </table>					Date	Initial	Date	Initial	Date	Initial	Date	Initial	Date	Initial																														
Date	Initial	Date	Initial	Date	Initial	Date	Initial	Date	Initial																																								
Part B: Preplanning Documentation				Part C: Special Precautions and Considerations																																													
	Yes	No	N/A		Yes	No	N/A		Yes	No	N/A																																						
Contractor hazard assessment (e.g. JHA) required?				Is it necessary to notify other departments?																																													
Applicable procedures have been reviewed?				Are barriers, flagging, or warning signs required?																																													
Energy Isolation Form required?				Is bonding or grounding required?																																													
Electrical Equipment Isolation and Work Clearance Form required?				All workers have current required orientation?																																													
Confined Space Permit required? <i>Permit #</i>				Has containment been provided for any liquid release?																																													
Critical Lift Plan required?				Is spark containment/control required?																																													
Serious Lift Plan required?				Facility Emergency Shutdown Devices considered?																																													
Fall Protection Plan required?				Have precautions been taken for X-ray/radiation work?																																													
Excavation Checklist required?				Special PPE requirements? If yes, specify below																																													
Ground Disturbance Permit required?				All workers have applicable safety training?																																													
Open System Job Planning Template Required?				Site specific hazards identified and discussed?																																													
Additional preplanning requirements from Permit Issuer: <i>Use this space to indicate simultaneous operations that may affect the working group, etc. (e.g. tank fill occurring, pig launching/receiving) or other special comments/instructions</i>				Is a fire watch required? Other special precautions or considerations:																																													
<b>Part D: Area Atmospheric Testing</b>																																																	
Is gas testing/monitoring required? <input type="checkbox"/> No <input type="checkbox"/> Yes ( <input type="checkbox"/> Continuous <input type="checkbox"/> Periodic _____ )																																																	
	Initial Result	2 <sup>nd</sup> Result	3 <sup>rd</sup> Result	4 <sup>th</sup> Result	5 <sup>th</sup> Result	6 <sup>th</sup> Result	7 <sup>th</sup> Result	8 <sup>th</sup> Result																																									
LEL - Flammable Vapors: LEL (0-10%)																																																	
Oxygen: 0,19.5-23%(CAN) 23.5% [US]																																																	
Hydrogen Sulphide: H <sub>2</sub> S (<10ppm)																																																	
Carbon Monoxide: CO (<25ppm)																																																	
Benzene (<0.5ppm)																																																	
Other																																																	
Time of Test																																																	
Tester's Name (initial must be completed by Enbridge Rep)																																																	
<b>Part E: Permit Approval</b>																																																	
Work cannot begin until the required approvals are on this document and a field level hazard assessment has been completed by the work group. All persons performing this work must comply with Enbridge safety policies and government regulations. Work must stop immediately should conditions change/new hazards appear or an emergency occur on the site.																																																	
Permit Issuer Name: _____ Signature: _____ Ph #: _____ Transfer of Responsibility Name: _____ Date/Time: _____ Signature: _____ Ph #: _____						Permit Receiver Name: _____ Company: _____ Signature: _____ Ph #: _____ Transfer of Responsibility Name: _____ Date/Time: _____ Signature: _____ Ph #: _____																																											
<b>Part F: Permit Returned</b>																																																	
Returned by	Received by			Date/Time Returned		MM/DD/YY	Time																																										
<input type="checkbox"/> FLHA(s) returned for the work	Comments: (e.g. work complete, ongoing, incomplete; area cleaned up)																																																

Distribution: White – Permit Receiver, Gold – Permit Issuer

Retain white copy for 2 years

VERSION 83 (Revised March, 2019)

**APPENDIX C: WORK AUTHORIZATION FORM**

**CAN000000**

**Work Authorization Form**



Part A: Work Details				
Emergency Contact: _____ (Name) (Ph #)	Date/Time Issued	MM/DD/YY	Time	
Alternate: _____ (Name) (Ph #)	Date/Time Expired	MM/DD/YY	Time	
Fire/Police/Ambulance: _____	Authorization Extended (new expiry)	MM/DD/YY	Time	
Emergency Assembly Area: _____	Extension Authorized by: _____ Issuer or Designate			
Location: <i>Physical address, geographical description</i>	Suspended at: MM/DD/YY Time Receiver Initials			
Work Scope/Description	Revalidated at: MM/DD/YY Time Issuer Initials			
	Frequency of Contact with Permit Issuer or Designate: <input type="checkbox"/> Not applicable <input type="checkbox"/> Daily <input type="checkbox"/> Weekly <input type="checkbox"/> Other: _____			
	Date			
	Initial			
	Date			
Initial				
Part B: Term and Conditions of Work Authorization				
Operational and/or site specific hazards reviewed and discussed (e.g. Facility Hazard Assessment)? <input type="checkbox"/> No <input type="checkbox"/> Yes <input type="checkbox"/> N/A				
Potential Conflicts Exist On-site due to Multiple Workgroups? <input type="checkbox"/> No <input type="checkbox"/> Yes <input type="checkbox"/> N/A				
Work Coordination Meeting Attended? <input type="checkbox"/> No <input type="checkbox"/> Yes <input type="checkbox"/> N/A (Document Potential Conflict Mitigation Measures Below)				
<i>Terms and conditions: Use this space to indicate how operational and/or site specific hazards were reviewed and discussed, work restrictions, simultaneous operations that may affect the working group (e.g. tank fill occurring, pig launching/receiving), additional Company Inspectors, etc. or other special comments/instructions</i>				
Part C: Work Authorization				
Work cannot begin until Safe Work Permit(s) has been issued and a field level hazard assessment has been completed by the work group. All persons performing this work must comply with Enbridge safety policies and government regulations. Work must stop immediately should conditions change/new hazards appear or an emergency occur on the site.				
Issuer: Name: _____  Signature: _____  Phone Number: _____	Company Inspector: <input type="checkbox"/> LPE <input type="checkbox"/> MP <input type="checkbox"/> Ops Name: _____  Signature: _____  Phone Number: _____			
Part D: Work Authorization Returned				
Returned by	Received by	Date/Time Returned	MM/DD/YY	Time
Comments:				

Distribution: White – Inspector(s), Gold – Issuer

Retain white copy for 2 years

VERSION 1.1 (Revised March 1, 2018)

## CHANGE LOG

Section	Version 1.3	Version 1.4
Entire Document		Clerical corrections including spelling, grammar, and document names.
6.1.3	The Enbridge operations representative responsible for a contractor shall document an exemption and provide copies to the contractor, operations management, and employee(s) responsible for the location(s).	The Enbridge operations representative responsible for a contractor shall document an exemption on the Long Term Operations Contractor Personnel Exemption Form, and provide copies to the contractor, operations management, and employee(s) responsible for the location(s).
6.4	Spot checks are an activity that can be tracked within Safety Leadership In Action (SLIA) program and should be completed on a monthly basis.	Removed reference to SLIA: Spot checks are an activity that should be completed on a monthly basis.
8.0		Added related document: - Long Term Operations Contractor Personnel Exemption Form
6.1.7, 6.2.3		Updated terminology from incident and investigation to event and analysis to align with Management System Framework - Event Analysis.

<End of Document>



---

# Standard

---

## Safety Meeting, Tailgate and Toolbox Talks

---

**Effective Date:** 2019-03-30

**Version #:** 1.5

**Version Date:** 2024-03-28

---



This page intentionally left blank



**Document Version Register**

Version Number	Version Date	Approved By	Section Number and Title	Details of Version
1.0	2019-03-30	Sean Evans	Whole Document (New Standard)	This is the new H&S standard that was developed as part of the LP   MP Safety Manual Transition Project
1.1	2019-10-31	Sean Evans	Section 5.0	See change log
1.2	2019-06-01	Sean Evans	Section 2.0	Alignment with Contractor Safety Specifications
1.3	2021-12-01	Murray Evenson	9.0, 10.0	Updated section 9 to reflect the appropriate review process Added reference to section 10 – refer to change log
1.4	2022-07-19	Jeff Safioles	6.2	See change log for details
1.5	2024-03-28	Troy Croft	All sections 6.1	Clerical corrections Updated terminology from incident and investigation to event and analysis.

Uncontrolled Copy if Printed or Downloaded

Internal Information



This page intentionally left blank

---

## Table of Contents

1.0 Purpose .....	2
2.0 Scope .....	2
3.0 Prerequisites.....	2
4.0 Definitions & Acronyms .....	2
5.0 Roles & Responsibilities .....	3
6.0 Standard-Specific Requirements .....	4
6.1 Safety Meeting Minimum Requirements .....	4
6.2 Prejob Meetings/Tailgate Meetings Minimum Requirements .....	5
6.3 Toolbox Talk Minimum Requirements .....	6
6.4 Attendance Expectations .....	7
7.0 Training Requirements .....	7
8.0 Related Documents .....	8
9.0 Standard Review .....	8
10.0 References .....	8
11.0 Appendix.....	8
11.1 Safety Meeting Best Practices – Opportunities for Improvement.....	8
11.2 Toolbox Talks Best Practices – Opportunities for Improvement .....	10
Change Log.....	11



## 1.0 PURPOSE

The purpose of the Safety Meetings, Tailgate and Toolbox Talk Standard is to define a consistent process on how safety meetings and toolbox talks will be performed across the LP business unit and projects completed on behalf of LP. The standard will provide:

- A process that empowers People Leaders to effectively deliver safety messaging to the frontline
- Improved relevance of safety messaging along with a corresponding call to action for participants
- Assurance that frontline safety concerns are logged, addressed, closed and communicated in a timely manner, and
- Tracking and feedback measures to ensure the process is sustainable and improves over time

## 2.0 SCOPE

This standard applies to LP Operations and Projects being completed for LP.

Contractors and subcontractors shall comply with Enbridge health and safety requirements set out in this standard, as articulated within applicable contractor safety specifications. If a contractor or subcontractor has a health and safety standard or policy materially different from Enbridge's, the contractor/subcontractor shall follow the most stringent requirement. Contractors and subcontractors are still obligated to meet the requirements of all applicable laws related to this Standard.

In the event a contractor's or subcontractor's standard exceeds the requirements of this standard, Enbridge may, in its sole discretion, choose to adopt the contractor's or subcontractor's standard for any given contract or work order.

## 3.0 PREREQUISITES

Event Lessons Learned Standard

## 4.0 DEFINITIONS & ACRONYMS

*Call to Action*—A call to action from Leadership is direction to the frontline based on trended data provided on the department or business area. An example would be job observation trends showing increasing at-risk behaviour due to gas monitors that have not been bump tested prior to being worn. The call to action would be ensuring that all gas monitors are bumped prior to use.

*FLHA* – Field Level Hazard Assessment

*Tailgate Meeting*—used interchangeably with Pre-Job Meeting. A meeting completed on a daily basis at the start of each shift to review the daily work plan or safe work permit and the

associated health & safety issues associated. In some cases a Tailgate or Pre-job meeting will be completed prior to commencing with a high risk task.

*Toolbox talk*—an informal meeting that focuses on safety topics related to a specific job, hazard, safe work practice or learning intended to facilitate health & safety discussions on the worksite and improve organizational safety culture.

## **5.0 ROLES & RESPONSIBILITIES**

People Leaders shall:

- Provide sufficient resources to effectively implement this standard;
- Ensure the scheduling of safety meetings is done in advance;
- Ensure the proposed content is timely and relevant for the project or department;
- Ensure that all safety concerns are logged and tracked in a manner that is directly visible to the frontline during the safety meeting and accessible to the worker thereafter;
- Ensure that the concerns raised are addressed in a timely manner;
- Assign a safety meeting facilitator on a rotating basis for each meeting or ensure that there is a Safety Representative assigned to either coordinate or facilitate each meeting;
- Provide feedback and coaching to safety meeting facilitator and/or presenters;
- When designated, create content for the safety meeting that is timely and relevant for their department;
- Ensure that meeting minutes are completed, logged and shared with employees and contractors on a timely basis;
- Regularly review safety meeting action logs to ensure that action management tasks are logged, tracked, closed and communicated in a timely manner;
- Ensure People Leaders, employees and contractors display appropriate behaviors specific to safety meeting and toolbox talks including attendance, engagement and support;
- Perform toolbox talks with department and contractors on a regular basis;
- Provide positive feedback and support to employees who provide safety concerns at safety meetings and toolbox talks;
- Engage frontline workers during toolbox talks through questioning and solicitation for feedback on the topic discussed; and
- Monitor and assess 'fit for duty' of team during toolbox talks.

Employees shall:

- Be knowledgeable in the requirements and expectations of this standard;
- Prepare and facilitate safety meeting if requested;
- Bring forward safety concerns from the worksite to be addressed at the safety meeting or toolbox talks;
- Prepare and present safety moment or other topics at the safety meeting if requested; and
- Engage in conversation and discussions within safety meeting and toolbox talks as appropriate.

Safety Team shall:

- Provide timely advice, support and assistance to People Leaders, employees and contractors in the implementation of this standard;
- Support people leaders with content for safety meetings and toolbox talks where appropriate;
- Escalate any safety action log concerns or discrepancies to the appropriate people leader; and
- Provide continual improvement opportunities to people leaders.

Safety Shared Services shall

- Be responsible for the maintenance and continuous improvement of this standard; and
- Be responsible for the development, distribution and library archiving of general content to be utilized for safety moments and toolbox talks.

## **6.0 STANDARD-SPECIFIC REQUIREMENTS**

All employees, contractors and sub-contractors shall attend regularly scheduled safety meetings to discuss current and relevant topics related to environment, health and safety.

Pre-job/tailgate meetings are complete prior to the start of a shift or high-risk task.

Toolbox talks will be completed on a regular basis as determined necessary by the people leader or directed by the region or project.

### **6.1 SAFETY MEETING MINIMUM REQUIREMENTS**

Each safety meeting must meet the minimum requirements:

- Safety moment;
- Safety concerns action log review and new business;

- Review area specific trending;
  - Event reviews and event lessons learned;
  - Leading and lagging metric trends;
  - Call to action from leadership.
- Safety topic presentations; and
- Other relevant agenda topics.

The safety concerns action log review and new business agenda item is the opportunity for employees and contractors to bring forward safety concerns that need to be discussed and addressed. The action log tracks the status of each of these concerns that have been brought forward until closure. Safety meetings shall provide adequate time for the frontline to present safety concerns to people leader(s) and be given an update on the status of previously logged action items. It is the people leader(s) accountability to ensure that all safety concerns are logged and tracked in a manner that is directly visible to the frontline during the safety meeting and accessible to the worker thereafter. It is also the people leader(s) accountability to ensure that the concerns are addressed in a timely manner.

Area specific trending provides the opportunity to review event lessons learned, trending from leading and lagging metrics as well as call to action requirements that are specific to the region or project. This may also include information and data from other regions or projects that is applicable and appropriate for review. This portion of the agenda only needs to be included if appropriate or applicable to the audience. For more information see the *Lessons Learned Standard*.

Safety topic presentations and other relevant agenda topics include Quarterly Scorecard Reviews, external safety alerts, executive safety message reviews, review of proposed changes to safety Standards and other safety related material. Again, this portion of the agenda only needs to be included if appropriate or applicable to the audience and approved by the appropriate People Leader.

For more information on safety meeting improvement opportunities see the Appendix of this Standard.

## **6.2 PRE-JOB MEETINGS/TAILGATE MEETINGS MINIMUM REQUIREMENTS**

The following types of work shall have a specific pre-job meeting with workers involved in the task to discuss the specific hazards associated with the job:

- High voltage electrical work;
- Serious and critical lifts;
- Confined space entry;
- Ground disturbance;

- Work around overhead power lines;
- Open system work;
- Pigging;
- Tie-ins; and
- Specific one-off jobs that are hazardous.

Pre-job meetings must include all work groups involved in job planning and job execution. For example, if Operations has conducted the lock out for a PLM job, Operations must attend the pre-job meeting to review the lock out.

On a daily basis at the start of each shift, a tailgate meeting must be conducted to review the daily work permit and health and safety issues associated with the day's work, or in some cases, prior to a specific high-risk task.

People Leaders may choose to use the following questions to engage conversation during the Pre-job/tailgate meetings:

1. What are the highest risked tasks within the job scope for today?
2. What could go wrong while completing these tasks?
3. How are we going to manage these hazards when completing our FLHA at the worksite?
4. What event would have to happen during the completion of these tasks to trigger a stoppage of work?
5. What were the learnings and pertinent hand over information from last shift or the last time this task was performed?
6. Solicit any outstanding safety concerns from the team.

During pre-job meeting activities, if an isolation point is found to be tagged or labeled incorrectly or the tag/label is missing, any work taking place shall be stopped until the tag or label is corrected or replaced. Refer to section '6.6 – Lockout/Tagout Assurance Process for Asset Management' in the Control of Hazardous Energy Safety Standard.

### **6.3 TOOLBOX TALK MINIMUM REQUIREMENTS**

A toolbox talk is an informal safety meeting that focuses on safety topics related to the specific job, such as workplace hazards and safe work practices. Meetings are normally short in duration and are generally conducted at the job site prior to the start of a shift, during a coffee break, prior to lunch ending or as directed by the people leader. It is an effective method to increase engagement between people leaders and their reports, refresh a worker's safety knowledge, cover last minute safety checks and facilitate the exchange of information between new and experienced workers.

Toolbox talks are also intended to facilitate health and safety discussions on the job site, promote safety awareness and learning as well as improve an organization's safety culture overall.

Examples of material that could be covered within a toolbox talk include:

- An applicable event lessons learned document (see *Lessons Learned Standard*);
- A recently completed field level hazard assessment by the team providing positive feedback and continual improvement opportunities;
- An example of an excellent safety observation that was recently submitted by a member of the crew;
- Current safety observation trending results, where available;
- An applicable external safety alert;
- Discussion on a recent emergency response exercise that was completed by the team;
- Review of an executive safety message; and
- Review an existing toolbox talk on a specific safety topic developed by the Health & Safety Department. See ELink for access to library.

Whichever toolbox talk format is chosen by the People Leader, there are several mandatory elements which must be present:

- Toolbox talks discussions or information provided must be safety related;
- The information provided is timely and relevant to the audience and the work they do; and
- There is a call to action on the information provided for the workers to institute within the upcoming work.

For more information on toolbox talk improvement opportunities please see the Appendix of this Standard.

## **6.4 ATTENDANCE EXPECTATIONS**

Safety meeting, pre-job/tailgate meeting and toolbox talk attendance requirements for employees and contractors is mandatory unless specific direction is provided by the Region or Project.

Attendance requirements for safety meetings and toolbox talks for People Leaders will be determined at a Regional and Project basis.

## **7.0 TRAINING REQUIREMENTS**

Personnel working in the field must be knowledgeable in this Standard and may be assigned applicable training as driven by the Safety Training Matrix.

Reference the Health & Safety training syllabi and matrices for further information and training re-certification requirements.

## **8.0 RELATED DOCUMENTS**

Not applicable

## **9.0 STANDARD REVIEW**

A subject matter expert (SME) will perform a technical review of this standard every two years to determine the accuracy of the content/information. The SME shall solicit input from applicable stakeholders to ensure the effectiveness of the standard. Any suggested changes must be reviewed and approved by the designated document owner.

## **10.0 REFERENCES**

Occupational Safety and Health Administration (OSHA)

- Hazard Communication, 29 CFR 1926.0059

Canada Labour Code, Part II – Occupational Health & Safety

- 124 Duties of Employers
- 125 Duties of Employees
- 135 Work Place Health & Safety Committees
- 136 Health & Safety Representatives

Canadian Occupational Safety & Health (COSH) regulations

- Part XIX Hazard Prevention Program

## **11.0 APPENDIX**

### **11.1 SAFETY MEETING BEST PRACTICES – OPPORTUNITIES FOR IMPROVEMENT**

Feedback on the People Leader's/presenter's performance should be used as a coaching opportunity keeping in mind that public speaking is not for all people, nor have all the presenters been adequately trained. Feedback to the presenter's performance should tie to their level of experience. The rooms and access to a computer for preparation can negatively impact delivery and the outcome of the meeting.

**Preparation and Content:** low prep time leads to reading which in turn leads the audience to reduce how much value the presenter (and their leader) places on the topics discussed.

1. Was the timing effective? (day of week/shift, a.m./p.m.)
  - a. Are workers focusing on lunchtime complete the or breaks catching the bus at the end of the day?

- b. Did the presenter rush through agenda?
2. Is there a clear and logical agenda?
  - a. Was there an agenda to follow?
  - b. Does the agenda allow topics/conversation to flow?
3. Was the content relevant to the area and audience?

**Delivery:** the intent of this section is to see whether any part of the setup is distracting (thereby disengaging to the audience)

1. Were presentation and material aids visible?
  - a. Is the screen large enough to be seen by people in the back of the room?
  - b. Were there any distractions from focusing on the presentation material?
2. Was the presentation heard by all?
  - a. Did the background noise drown out the presentation?
  - b. Is audio equipment needed/available?
3. Is the presenter experienced in this type of delivery?
  - a. Did the presenter appear nervous/confident and did that affect the presentation?

**Environment:** the intent of this section is to see whether any part of the room is distracting (thereby disengaging to the audience)

1. Was the location suitable?
  - a. Was the seating adequate for the crew size?
  - b. Did the layout of the room distract from the presentation? i.e., presenter had back to audience
  - c. Does the room have adequate audio/visual equipment available for use in the presentation?

**Result:** The intent of this section is to rate whether the presentation maintained the audience's attention throughout the presentation.

1. Was the meeting too long or too short?
  - a. Did the meeting drag on or feel rushed?
  - b. Was sufficient time allotted to each section?
2. Was the audience attentive?
  - a. Did the audience members remain engaged (not fall asleep)
  - b. Cellphone use?
  - c. Chatting amongst themselves/side bar conversations?

**Action management:** The intent is to ensure consistent timely follow up and completion of actions.

1. Was there follow up to previous action items?



2. Were new action items captured?
  - a. Were the actions written down on the action log/minutes?

**Overall Effectiveness:** The intent of this section is to rate whether the overall safety meeting was successful or not regardless of how well the individual sections were done.

1. Other observations?
  - a. Did management attend (supervisor and up), demonstrating visible leadership?
  - b. Were other guests in attendance i.e., safety rep, H&S advisor, industrial hygiene to support the People Leader?
2. Is any part of the conversation worth sharing outside the business unit?
3. Recommendations for improvement?
  - a. What can be done better, added or dropped to make the safety meeting more relevant or effective?

## **11.2 TOOLBOX TALKS BEST PRACTICES – OPPORTUNITIES FOR IMPROVEMENT**

**Purpose:** Evaluating the effectiveness of the toolbox talk. The areas of focus for the assessment are: preparation & content, delivery & environment, action management and overall effectiveness.

### **Preparation and Content:**

1. Was the timing effective? (starting point for the shift)
  - a. Does the timing support the shift start up activity?
  - b. Did the People Leader rush through the toolbox talk just to get employees out to work?
2. Was the content relevant to the employees and the work planned for that shift?
  - a. Was there an agenda to follow? (does not have to use visual aids)
  - b. Does the agenda allow topics/conversation to flow?
  - c. Was the supervisor familiar with the content, indicating they had reviewed it before?

### **Delivery and Environment:**

1. Was the presentation heard by all?
  - a. Did the background noise drown out the presentation?
  - b. Is audio equipment needed and/or available?
  - c. Is the location suitable?
2. Is the People Leader experienced in this type of delivery?
  - a. Did the People Leader appear nervous or confident and did that affect the delivery?
  - b. Did the People Leader focus the delivery on the activities of the upcoming shift?
  - c. Did the People Leader engage with the employees through asking questions, soliciting feedback, scanning room ensuring no employees are having sidebar conversations?

**Overall Effectiveness:**



1. Other observations?
  - a. Did management attend (Manager and up), demonstrating visible leadership?
  - b. Were other guests in attendance i.e., safety rep, H&S advisor, industrial hygiene to support the People Leader?
2. Is any part of the conversation worth sharing outside the business unit?
3. Recommendations for improvement?
  - a. What can be done better, added or dropped to make the toolbox talk more relevant or effective for the starting the shift off with the right focus?
4. Was the meeting too long or too short?
  - a. Did the meeting drag on or feel rushed?
  - b. Was sufficient time allotted to each section?
5. Was the audience attentive?
  - a. Did the audience members remain engaged (drift into sidebar discussion)?
  - b. No cellphone use?
  - c. Chatting amongst themselves?

### CHANGE LOG

Section	Version 1.4	Version 1.5
Entire document		Clerical corrections including spelling, grammar, and document names.
6.1		Updated terminology from incident and investigation to event and analysis.

<End of Document>



---

# Standard

---

## Safety Observation

---

**Effective Date:** 2019-03-30

**Version #:** 1.3

**Version Date:** 2024-03-28

---



This page intentionally left blank





This page intentionally left blank

---

## Table of Contents

1.0 Purpose .....	2
2.0 Scope .....	2
3.0 Prerequisites.....	2
4.0 Definitions & Acronyms .....	2
5.0 Roles & Responsibilities .....	2
6.0 Standard-Specific Requirements .....	3
6.1 Types of Safety Observations: .....	3
6.2 Safety Observation considerations:.....	4
6.3 Action Plan:.....	4
6.4 Quality Assessments: .....	4
6.5 Tracking/ Trending Methods:.....	4
6.6 Resource Requirements .....	5
7.0 Training Requirements:.....	5
8.0 Related Documents .....	5
9.0 Standard Review .....	5
10.0 References .....	5
11.0 Appendix.....	6
11.1 Safety Observation Process .....	6
11.2 Quality of Safety Observations - Scorecard .....	8
Change Log.....	9

## 1.0 PURPOSE

The Safety Observation Standard is to provide a proactive approach to engage the workforce by focusing on positive reinforcement of safe behaviors, discussing and correcting unsafe behaviors, obtaining agreement to change at-risk behavior and promoting two-way communication of safety related concerns.

## 2.0 SCOPE

This standard applies to LP Operations and Projects being completed for LP.

Contractors and subcontractors shall comply with Enbridge health and safety requirements set out in this standard, as articulated within applicable contractor safety specifications. If a contractor or subcontractor has a health and safety standard or policy materially different from Enbridge's, the contractor/subcontractor shall follow the most stringent requirement. Contractors and subcontractors are still obligated to meet the requirements of all applicable laws related to this standard.

In the event a contractor's or subcontractor's standard exceeds the requirements of this standard, Enbridge may, in its sole discretion, choose to adopt the contractor's or subcontractor's standard for any given contract or work order.

## 3.0 PREREQUISITES

Safety Meeting, Tailgate and Toolbox Talk Standard

## 4.0 DEFINITIONS & ACRONYMS

*Behavior*—an observable action.

*Imminent Danger*—any conditions or practices in which danger exists that could reasonably be expected to cause death or serious physical harm.

*Safety Observation*—an observation of safe or at-risk behavior, which includes an interaction between the observer and the observed person to reinforce or correct the observed behavior. The observation must document both interaction and the reinforcement or correction of the observed behavior as well as the agreement to improve moving forward. A safety observation is not the documentation of a hazardous condition (identifying a trip hazard or a missing guard on a tool—for more information see the *Inspection Standard*).

## 5.0 ROLES & RESPONSIBILITIES

People Leaders shall:

- Demonstrate program commitment and active participation,
- Review safety observations completed by direct reports,



- Complete safety observation process by ensuring data entry into EnCompass,
- Ensure that the completed observation meets the definition of a quality safety observation as defined herein, and
- Ensure relevant learnings and resulting trends from safety observations are reviewed and shared with team.

Observing Persons shall:

- Schedule safety observations on Enbridge sites or actively seek opportunities for ad-hoc safety observations,
- Engage employees with respect,
- Provide constructive feedback to the observed person,
- Input safety observation data into EnCompass or on safety observation card, and
- If applicable, enter action item into EnCompass and/or project documents.

Observed Persons shall:

- Be receptive to the observer's observation feedback,
- Come to an agreement on safe work behavior, and
- Bring forward any safety concerns.

Safety Team shall:

- Provide timely advice, support and assistance to people leaders and contractors in the implementation of this standard, and
- Provide quality review of safety observation submissions and report findings to people leaders as appropriate.

Safety Shared Services shall:

- Be responsible for the maintenance and continuous improvement of this standard, and
- Provide reporting and metrics on safety observation process as required.

## **6.0 STANDARD-SPECIFIC REQUIREMENTS**

### **6.1 TYPES OF SAFETY OBSERVATIONS:**

Planned—Scheduled safety observations to review worker's behavior and adherence to procedures, critical task(s) and/or work that is known to be occurring. These can result in both safe and/or at-risk behavior observations.

Ad hoc—Safety observations that are observed and acted upon spontaneously. They do not involve scheduling and can result in both safe and/or at-risk behavior observations.

Both types of safety observations shall be completed in accordance with the Safety Observation Process outlined in Appendix A.

## 6.2 SAFETY OBSERVATION CONSIDERATIONS:

1. Observe: Observations should focus on behaviors (safe and at-risk behaviors)\*.
2. Comment: Speak to the observed individual and comment on what was observed. Remember to use Enbridge's core values of integrity, safety, and respect to frame your conversation.
3. Discuss: A two-way conversation about the safety observation with the observed individual is the most important part of the observation.
4. Come to an agreement:
  - a. Safe observed behavior: reinforce the observed behavior and commitment to continue to work safely.
  - b. At-risk observed behavior: encourage the person to stop performing the at-risk behavior, discuss why it's at-risk. Obtain a commitment from the observed to improve their safety now and in the future.
5. Additional discussion: ask for and discuss other safety improvement opportunities.
6. Acknowledge: remember to thank the observed employee and document the conversation in EnCompass or on a safety observation card.

\*Note: Stop and intervene on work whenever imminent danger is present or there is potential for an event to occur.

## 6.3 ACTION PLAN:

If a safe behavior observation or ensuing conversation leads to an enhancement within the Enbridge Health and Safety Management Program, an action item must be created and tracked through to completion.

If an at-risk behavior cannot be corrected with immediate action, an action item must be created and tracked through to completion within Encompass.

## 6.4 QUALITY ASSESSMENTS:

To promote continuous improvement of our safety observations, Enbridge has created a tool to help quantify the quality of safety observations completed. This tool will set the criteria to allow reviewers to assess the completed safety observation and highlight opportunities for improvement.

## 6.5 TRACKING/ TRENDING METHODS:

Uncontrolled Copy if Printed or Downloaded

Metrics for the safety observation program will be quantified, tracked, and trended using the appropriate Enbridge tool (i.e., EnCompass, project administrative documents).

Information derived from tracking and trending shall be shared with the workforce as applicable. See the Safety Meeting, Tailgate and Toolbox Talk Standard for more information.

## **6.6 RESOURCE REQUIREMENTS**

Computer

Scantron Scanner (if required)

Safety Observation Cards

EnCompass access (if required)

## **7.0 TRAINING REQUIREMENTS:**

Personnel working in the field must be knowledgeable in this Standard and may be assigned applicable training as driven by the Safety Training Matrix.

Reference the Health & Safety training syllabi and matrices for further information and training re-certification requirements.

## **8.0 RELATED DOCUMENTS**

Record Retention Policy

Safety Observation Card

Safety Observation QRC

Safety Observation Training

## **9.0 STANDARD REVIEW**

A subject matter expert (SME) will perform a technical review of this standard every two years to determine the accuracy of the content/information. The SME shall solicit input from applicable stakeholders to ensure the effectiveness of the standard. Any suggested changes must be reviewed and approved by the designated document owner.

## **10.0 REFERENCES**

Not Applicable

## 11.0 APPENDIX

### 11.1 SAFETY OBSERVATION PROCESS

Step #	Step	Step Description
1	Observe work tasks (scheduled or ad hoc).	Observer: Ensure that the worker is aware of the observation. Observe any/ all aspect(s) of a work task conducted by the Observed Person. Focus on behaviors (safe and at-risk)
2	Comment on task	Observer: Speak to the observed individual and comment on what was observed. Remember to use Enbridge's core values of Safety, Integrity, and Respect to frame your conversation. Ask questions, identify safe or at-risk behaviors. Provide coaching if required.
3	Discuss the observation with the Observer.	Observed: Acknowledge feedback, answer questions, provide insight as to the work being conducted
4	Come to an agreement	Observer: Safe Observed Behavior: Reinforce the observed behavior and commitment to continue to work safely. At-Risk Observed Behavior: Encourage the person to stop performing the at-risk behavior and agree to actions to improve their safety now and in the future.
5	Additional Discussion	Observer: Ask for and discuss other safety improvement opportunities.
6	Acknowledgement	Observer: Thank the observed employee for participating in the safety observation
7	Capture Observation details	Observer: Enter observation details onto the appropriate tool (EnCompass System, Scantron Safety Observation Card, or Safety Observation Card). Note that another individual can enter the observation card into EnCompass as determined by Regional or Project process.
8	Observation Details approved?	People Leader: Review observation details captured on observation media (EnCompass, Scantron Safety Observation Card, or Safety Observation Card). Determine if sufficient information and action has been taken. <ul style="list-style-type: none"> <li>• If yes, then Step 9, "Approve and Close Observation"</li> <li>• If no, then provide feedback and coaching to Observer, then Step 7. "Capture Observation Details"</li> </ul>
9	Approve and close Observation	People Leader: Approves and closes out observation

Uncontrolled Copy if Printed or Downloaded

Internal Information

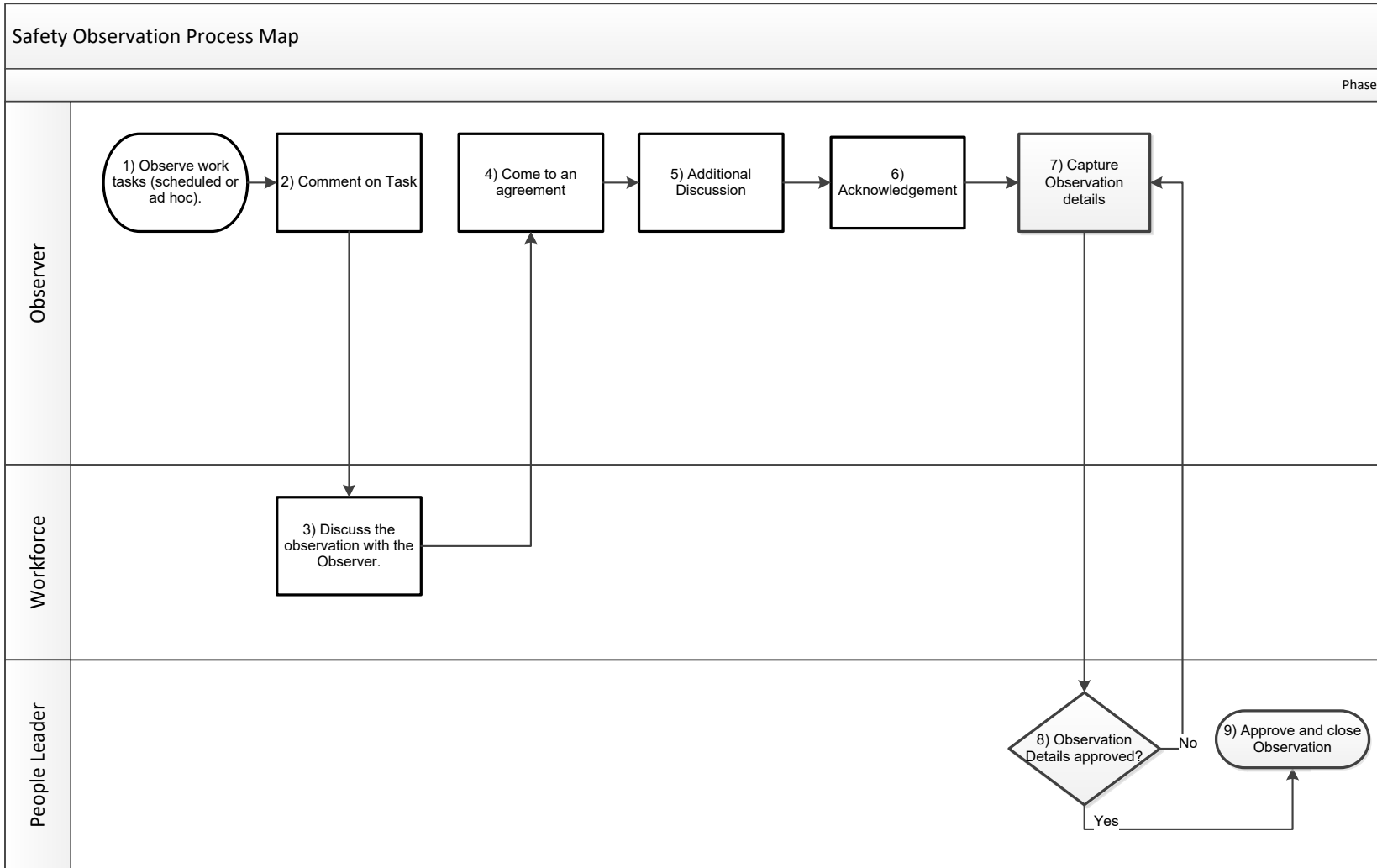



**11.2 QUALITY OF SAFETY OBSERVATIONS - SCORECARD**

Scoring Aspect	Criteria	Score
Form is filled out completely	Form must be filled out completely to receive full points. If not, then 0 points awarded	0 20
Quality Positive Aspects Identified		0 5 10 15 20
Areas for improvement listed or none required	Areas for improvement listed with detail were applicable and appropriate for the observation, OR Positive findings listed with detail, so no areas for improvement were required	0 5 10 15 20
Comments included and discussed	Comments/ discussion were noted in detail	0 5 10 15 20
Overall quality of the form	Quality of details included	
<b>TOTAL SCORE</b>		



---

## CHANGE LOG

	Version 1.2	Version 1.3
Entire document		Clerical corrections including spelling, grammar, and document names.
6.2		Updated terminology from incident and investigation to event and analysis.

<End of Document>



---

# Standard

---

## Safety Orientation and Visitor Access

---

**Effective Date:** 2019-03-30

**Version #:** 1.6

**Version Date:** 2024-03-28

---





This page intentionally left blank



**Document Version Register**

Version Number	Version Date	Approved By	Section Number and Title	Details of Version
1.0	2019-03-30	Sean Evans	Whole Document (New Standard)	This is the new H&S standard that was developed as part of the LP   MP Safety Manual Transition Project
1.1	2019-10-31	Sean Evans	5.0	See Change Log
1.2	2020-05-25	Sean Evans	2.0, 5.0	Alignment with Contractor Safety Specifications
1.3	2021-12-01	Murray Evenson	9.0	Updated section 9 to reflect the appropriate review process
1.4	2022- 05-13	Murray Evenson	6.0	Moved content from Hot Work & Ignition Sources Standard to this Standard as it was missed in the initial safety standards project (see change log)
1.5	2022- 07-19	Jeff Safioles	6.0	See change log for details
1.6	2024-03-28	Troy Croft	All sections 3.0, 6.0	Clerical corrections Alignment with Management System Framework - Event Analysis

Uncontrolled Copy if Printed or Downloaded



This page intentionally left blank

---

## Table of Contents

1.0 Purpose .....	2
2.0 Scope .....	2
3.0 Prerequisite .....	2
4.0 Definitions & Acronyms .....	3
5.0 Roles & Responsibilities .....	3
6.0 Standard – Specific Requirements .....	4
6.1 Employees .....	5
6.2 Contractors & Subcontractors .....	5
6.3 Visitors .....	6
7.0 Training Requirements .....	6
8.0 Related Documents .....	6
9.0 Standard Review .....	6
10.0 References .....	7
Change Log .....	7

---

## **1.0 PURPOSE**

The purpose of this standard is to ensure that all employees, contractors, subcontractors and visitors understand the safety requirements and expectations prior to accessing an Enbridge location.

## **2.0 SCOPE**

This standard applies to all LP Operations and Projects being completed for LP and contractors, subcontractors and site visitors who will be accessing an Enbridge LP site. Contractors and subcontractors shall comply with Enbridge health and safety requirements set out in this standard, as articulated within applicable contractor safety specifications.

In addition to these requirements contractors shall have their own orientation program. This program shall

- Familiarize new workers with the rules, policies, procedures, site-specific hazards and any other relevant requirements or health and safety matters,
- Similarly familiarize new workers with all Enbridge health and safety requirements,
- Ensure that all contractor and subcontractor personnel have completed any required site- or work-specific safety orientations prior to commencing any work at the work site, and
- Meet all pre-access requirements prior to accessing an Enbridge worksite.

## **3.0 PREREQUISITES**

Atmospheric Monitoring Standard

Confined Space Standard – Canada/ US

Control of Hazardous Energy Standard

Emergency Preparedness – Personal Safety Standard

Environmental Conditions Standard

Fall Protection Standard

Fatigue Management Standard

Ground Disturbance Standard

Hazard Communication & WHMIS Standard

Hazard Assessment & Control Standard

Hot Work & Ignition Sources Standard

Hoisting & Rigging Standard

---

Hydrostatic & Pneumatic Testing Standard  
Event Analysis Process  
Inspection Standard  
Personal Protective Equipment Standard (PPE)  
Respiratory Protection Standard  
Right to Refuse Dangerous Work Standard  
Safe Work Permit & Work Authorization Standard  
Safety Meeting, Tailgate & Toolbox Talk Standard  
Safety Observation Standard  
Storage and Transportation of Hazardous Materials Standard  
Tools & Equipment Standard  
Vehicle Operation Standard  
Walking-Working Surfaces and General Housekeeping Standard

## **4.0 DEFINITIONS & ACRONYMS**

*Visitors*—defined as any Enbridge or non-Enbridge individual that is not performing any assigned work activity on an Enbridge worksite (i.e., ROW, facility, construction site). An example of a visitor is any individual who is completing a supervised tour of an Enbridge worksite.

*Worksite*—the entire work area required for the work, including all Enbridge property, right of way, temporary working space and all right of way storage areas as required by Enbridge.

## **5.0 ROLES & RESPONSIBILITIES**

People Leader shall:

- Ensure that employees under their control comply with this standard;
- Ensure that their employees receive the required orientations prior to site access and or work commencement;
- Ensure all hiring personnel under their supervision are providing the required orientations to contractors and subcontractors prior to site access and or work commencement; and
- Ensure visitors receive the appropriate site-specific orientation and are fully escorted for the duration of their visit.

Employees, and visitors shall:

- Be responsible for participating in and completing the necessary orientations for the Enbridge locations they access and perform work within.

Contractors and subcontractors shall, as articulated within the applicable contractor safety specification:

- Be responsible for participating in and completing the necessary orientations for the Enbridge locations they access and perform work within.

Safety Team shall:

- Provide timely advice, support and assistance to people leaders in the implementation of this standard.

Safety Shared Services shall:

- Be responsible for the maintenance and continuous improvement of this standard.

## **6.0 STANDARD – SPECIFIC REQUIREMENTS**

Enbridge endorses a two-part safety orientation to its employees and contractors. Prior to performing work at an Enbridge location all employees, contractor and subcontractor personnel shall receive the Enbridge safety orientation and site-specific orientation.

The Enbridge safety orientation is available as an online self-guided e-course. The Enbridge safety orientation is both knowledge and risk-based and includes an introduction to the expectations at Enbridge as well as an explanation of why these expectations are important for the safety of our employees, contractors, public and environment.

The site specific (regional or project) orientation is delivered at the work location and provides insight into how to execute the expectations outlined in the Enbridge safety orientation.

The Enbridge safety orientation covers topics that include, but are not limited to:

- Health & Safety Policy;
- Environmental Policy;
- Personal protective equipment requirements, as applicable to the work environment;
- Event reporting procedures;
- Driver training requirements;
- Additional policies:
  - Workplace Alcohol and Drug Policy;
  - Respectful Workplace Policy;
  - Safety While Driving Policy;
  - Employee Driver's License and Driving Record Policy;

**Uncontrolled Copy if Printed or Downloaded**

- Enbridge Security and Photo Identification Policies;
- Right to refuse any work deemed to be unsafe including missing or mislabeled isolation points (refer to Refer to section '6.6 – Lockout/Tagout Assurance Process for Asset Management' in the Controls of Hazardous Energy Safety Standard.

The Site-Specific Orientation covers topics that include, but are not limited to:

- Expectations for personal protective equipment;
- Evacuation alarms (i.e., sirens or horns);
- Location of emergency exit gates, windsocks, assembly areas, smoking areas and first aid stations;
- Evacuation and emergency procedures (including muster points);
- Sign-in/out procedures and security requirements;
- Permit requirements;
- Hazardous & restricted areas;
- Review of site safety plot plan;
- Designated roads and parking areas;
- Vehicle seatbelt use and posted speed limits;
- Reporting unsafe acts/conditions, injuries or property damage;
- Site specific activity or work-site hazards; and
- Restrictions pertaining to communication devices and cameras with flashes.
- Firearms, weapons, archery equipment and pets are prohibited on all Enbridge locations.

## **6.1 EMPLOYEES**

The Enbridge safety orientation will be a onetime requirement for employees and Enbridge contractors that remain in continuous employment with Enbridge. The Enbridge safety orientation is a pre-requisite for participating in a site-specific orientation. Site-specific orientation is a requirement prior to commencing work at a specific region or project location.

## **6.2 CONTRACTORS & SUBCONTRACTORS**

The Enbridge safety orientation is an annual requirement for contractors hired by Operations and Projects in both Canada and the United States. The Enbridge safety orientation is a prerequisite for participating in a site-specific orientation. Site-specific orientation is a requirement prior to commencing work at a specific region or project location.



---

### **6.3 VISITORS**

Visitors shall be at the worksite only for work-specific purposes and will be required to:

- Attend the site-specific orientation; and
- Be escorted for the duration of their visit.

### **7.0 TRAINING REQUIREMENTS**

Personnel working in the field must be knowledgeable in this Standard and may be assigned applicable training as driven by the Safety Training Matrix.

Reference the Health & Safety training syllabi and matrices for further information and training re-certification requirements.

Enbridge employees, contractors and subcontractors shall be trained

- According to the applicable Enbridge training matrix and/or requirements in the applicable safety standard their work is related to;
- In the operation of vehicles, tools and equipment that they are required to use;
- In the safe work practices and hazards associated with the vehicles, tools and equipment they use;
- To safely carry out the tasks or work activities associated with their job function; and
- Beyond the requirements set out in this Standard when required by applicable legislation.

Contractors and subcontractors will follow their internal training requirements as outlined within their contract.

- Contractors shall be able to provide proof of training of its Contractor Personnel to an Enbridge Representative upon request.

### **8.0 RELATED DOCUMENTS**

Lifesaving Rules

Our Path to Zero

Health and Safety Training Syllabi & Matrices

### **9.0 STANDARD REVIEW**

A subject matter expert (SME) will perform a technical review of this standard every two years to determine the accuracy of the content/information. The SME shall solicit input from applicable stakeholders to ensure the effectiveness of the standard. Any suggested changes must be reviewed and approved by the designated document owner.

---

## 10.0 REFERENCES

Occupational Safety & Health Administration – Regulations (Standards – 29 CFR)

Canada Labour Code Part II - Canada Occupational Health and Safety Regulations

Occupational Health and Safety Training - CAN/CSA-Z1001-13

## CHANGE LOG

Section	Version 1.5	Version 1.6
Entire document		Clerical corrections including spelling, grammar, and document names.
3.0, 6.0		Updated terminology from incident and investigation to event and analysis.

<End of Document>



---

# Standard

---

## Storage and Transportation of Hazardous Materials

---

**Effective Date:** 2019-03-30

**Version #:** 1.4

**Version Date:** 2024-03-28

---



This page intentionally left blank

**STORAGE AND TRANSPORTATION OF HAZARDOUS MATERIALS STANDARD**

Version #: 1.4  
Version Date: 2024-03-28



**Document Version Register**

<b>Version Number</b>	<b>Version Date</b>	<b>Approved By</b>	<b>Section Number and Title</b>	<b>Details of Version</b>
1.0	2019-03-30	Sean Evans	Whole Document (New Standard)	This is the new H&S Standard that was developed as part of the LP   MP Safety Manual Transition Project
1.1	2020-06-01	Sean Evans	2.0	Alignment with contractor safety specifications
1.2	2021-12-01	Murray Evenson	9.0	Updated section 9 to reflect the appropriate review process
1.3	2023-07-25	Jeff Safioles	6.1.2	See change log
1.4	2024-03-28	Troy Croft	All sections 6.2.2, 8.0	Clerical corrections Alignment with Management System Framework - Event Analysis.

**Uncontrolled Copy if Printed or Downloaded**

**Internal Information**

**STORAGE AND TRANSPORTATION OF HAZARDOUS  
MATERIALS STANDARD**

Version #: 1.4  
Version Date: 2024-03-28



---

--	--	--	--	--

This page intentionally left blank

---

## Table of Contents

1.0	Purpose .....	2
2.0	Scope .....	2
3.0	Prerequisite: .....	2
4.0	Definitions & Acronyms .....	2
5.0	Roles & Responsibilities .....	3
6.0	Standard-Specific Requirements .....	4
6.1	Hazardous Materials Storage .....	4
6.1.1	Storage Cabinets .....	4
6.1.2	Storage in Buildings .....	5
6.1.3	Spill Containment .....	5
6.1.4	Transporting Hazardous Materials .....	5
6.1.5	Transportation of Fuel or Liquid Hazardous Materials .....	5
6.1.6	Required Documentation .....	6
6.2	Compressed Gas Cylinders .....	6
6.2.1	Compressed Gas Cylinder Storage .....	8
6.2.2	Compressed Gas Cylinder Transport .....	8
6.2.3	Aerosol Cans .....	9
6.3	Propane Bottles and Accessories .....	9
6.4	Leaks and Spills .....	10
7.0	Training Requirements .....	10
8.0	Related Documents .....	10
9.0	Standard Review .....	10
10.0	References .....	10
	<b>CHANGE LOG</b> .....	<b>11</b>

## **1.0 PURPOSE**

The purpose of this standard is to ensure that Enbridge workforce and contractors understand the hazards and requirements associated with handling or storing of hazardous materials and compressed gas.

## **2.0 SCOPE**

This standard applies to LP Operations and Projects being completed for LP.

Contractors and subcontractors shall comply with Enbridge health and safety requirements set out in this standard. If a contractor or subcontractor has a health and safety standard or policy materially different from Enbridge's, the contractor/subcontractor shall follow the most stringent requirement. Contractors and subcontractors are still obligated to meet the requirements of all applicable laws related to this standard.

In the event a contractor's or subcontractor's standard exceeds the requirements of this standard, Enbridge may, in its sole discretion, choose to adopt the contractor's or subcontractor's standard for any given contract or work order.

## **3.0 PREREQUISITE:**

Hazard Communication and WHMIS Standard

Hazard Assessment, Identification and Control Standard

## **4.0 DEFINITIONS & ACRONYMS**

*Combustible Liquids* - flashpoint at or above 37.8°C (100°F) and below 93.3°C (200°F). Combustible Liquids have the ability to burn at temperatures that are usually above working temperatures.

*Flammable Liquids (Canada)* - flashpoint below 37.8°C (100°F).

*Flammable Liquids (US)* - flashpoint at or below 93 °C (199.4 °F) divided into four categories:

Category 1 shall include liquids having flashpoints below 23°C (73.4°F) and having a boiling point at or below 35°C (95°F)

Category 2 shall include liquids having flashpoints below 23°C (73.4°F) and having a boiling point above 95°F (35°C).

Category 3 shall include liquids having flashpoints at or above 23°C (73.4°F) and at or below 60°C (140°F). When a Category 3 liquid with a flashpoint at or above 37.8°C (100°F) is heated for use to within 16.7°C (30°F) of its flashpoint, it shall be handled in accordance with the requirements for a Category 3 liquid with a flashpoint below 37.8°C (100°F).



Category 4 shall include liquids having flashpoints above 60°C (140°F) and at or below 93°C (199.4°F). When a Category 4 flammable liquid is heated for use to within 16.7°C (30°F) of its flashpoint, it shall be handled in accordance with the requirements for a Category 3 liquid with a flashpoint at or above 37.8°C (100°F).

*GHS* – Globally Harmonized System of Classification and Labelling of Chemicals

*Hazardous Materials* – A material, other than hazardous waste, that because of its quantity, concentration and physical or chemical characteristics, either individually or in combination with other substances is or poses a threat to the environment, humans or other living organisms.

*HAZCOM* – Hazard Communication

*HAZMAT* – Hazardous Materials

*SDS* – Safety Data Sheets are summary documents that provide information about the hazards of a product and advice about safety precautions. SDSs are usually written by the manufacturer or supplier of the product.

*TDG* – Transportation of Dangerous Goods

*WHMIS* – Workplace Hazardous Material Information System

## **5.0 ROLES & RESPONSIBILITIES**

People Leader shall:

- Ensure that direct reports are trained accordingly; and
- Ensure that direct reports are informed about the hazardous materials and compressed gases that they are using.

Worker shall:

- Use appropriate controls when working with hazardous materials and compressed gases;
- Carry proof of certification (HAZMAT/ TDG) at all times while performing transportation of hazardous materials work; and
- Complete the appropriate level of training based on applicable legislation (e.g., shippers/drivers).

Safety Team shall:

- Provide timely advice, support and assistance to People Leaders in the implementation of this standard.

Safety Shared Services shall:

- Be responsible for the maintenance and continuous improvement of this standard.

---

## **6.0 STANDARD-SPECIFIC REQUIREMENTS**

### **6.1 HAZARDOUS MATERIALS STORAGE**

Enbridge recognizes that the safe storage of hazardous materials is an essential component in keeping our employees safe.

Hazardous materials shall:

- Be stored indoors whenever possible;
- Be stored away from equipment and vehicle routes;
- Be stored away from moisture and excessive heat;
- Be stored on an impervious surface with containment capabilities (e.g., dikes, curbs); or if not available, on an impermeable containment structure (e.g., tray, containment pallet, tote);
- Be stored a minimum distance of 100 m [CAN] or 100 ft. [USA] from any body of water;
- Not be stored on ice; and
- Be separated from incompatible materials.

Flammable liquids shall be stored in the original container or in other approved portable containers. All containers shall be inspected regularly to ensure containment.

#### **6.1.1 STORAGE CABINETS**

The total maximum quantity of flammable liquids and combustible liquids stored indoors, outside of a storage cabinet shall not exceed:

- In Canada—600 L in closed containers, of which not more than 100 L may be flammable liquids; and
- In US—25 gallons of category 1 flammable liquids, 120 gallons of category 2,3 or 4 Flammable Liquids in containers, or 660 gallons of Category 2, 3, or 4 Flammable Liquids in a single portable tank.

The total maximum quantity inside a storage cabinet shall not exceed:

- In Canada – 500 L, of which not more than 250 L may be flammable liquids (Canada);
- In US - 60 gallons of Category 1, 2, or 3 flammable liquids (US), nor more than 120 US gallons of Category 4 flammable liquids (US).

Do not store combustible materials (e.g., cardboard, paper, wood) inside flammable liquid storage cabinets.

Do not locate more than three storage cabinets in a building, unless cabinets are placed in groups of three or less in one location and the groups of cabinets are placed at least 30 m (100 ft.) apart.

---

### **6.1.2 STORAGE IN BUILDINGS**

Flammable or combustible materials normally used in gas compressor or densitometer/instrument/sample building, may be stored there in quantities no greater than those required for everyday use in accordance with applicable legislation.

Store excess flammable or combustible materials (greater than those used daily) in a separate structure built of non-combustible material and located a safe distance from gas compressor buildings and densitometer/ instrument/ sample buildings.

Storage cabinets approved for fire protection are not required to be vented to the outdoors; however, where respiratory or other health hazards may exist from the accumulation of hazardous vapors, positive mechanical ventilation is required. Where ventilation systems are not used or required, closures for ventilation within cabinet openings shall remain in place.

### **6.1.3 SPILL CONTAINMENT**

Emergency spill cleanup equipment shall be readily accessible in close proximity to permanent fuel storage tanks.

If hazardous materials are stored in drums at a site, a hazardous materials spill kit shall be available at the site.

When transferring hazardous materials to or from storage tanks and drums, ensure spill control devices (e.g., spill pallets, absorbent pads, trays) are available, and use them to prevent contamination of soil, surface runoff water and groundwater.

### **6.1.4 TRANSPORTING HAZARDOUS MATERIALS**

All hazardous materials shall be transported in accordance with the Hazardous Materials Transportation (HAZMAT) regulations [USA], or with the Transportation of Dangerous Goods (TDG) regulations [CAN].

Persons who handle for transport, offer for transport or transport dangerous goods shall have valid HAZMAT (US) or TDG (CAN) certification and carry proof of certification at all times while performing work (when required by applicable legislation).

### **6.1.5 TRANSPORTATION OF FUEL OR LIQUID HAZARDOUS MATERIALS**

Do not transport or store extra fuel for vehicles and equipment in vehicle trunks or in passenger compartments.

Extra fuel for equipment shall be carried in approved containers that comply with CSA B376 [CAN] or with NFPA 30 and HAZMAT Regulations [USA].

Enbridge vehicles transporting more than 200 L [CAN] or 119 gal [USA] of fuel or liquid hazardous materials to unattended locations and/or ROW worksites shall be equipped with a spill kit containing:

- A shovel;
- 30 m<sup>2</sup> (36 sq. yd.) of 6-mil polyethylene sheeting; and
- 25 kg (55 lb.) of absorbent.

Any vehicle containing hazardous materials in amounts greater than or equal to 450 kg (1000 lb.) or 500 L (119 gal in the USA) shall have a placard affixed on each exterior side, showing the type of material being transported. Tank trucks shall carry placards at all times unless the truck has been completely purged and cleaned.

### **6.1.6 REQUIRED DOCUMENTATION**

Obtain shipping documents [CAN]/manifests [USA] from the material supplier. Shipping documents or manifests may be in any form as long as they include the following:

- Name of material,
- Hazard class,
- Identification number,
- Total quantity, and
- Emergency contact (Chemtrec 1-800-424-9300; CANUTEC 1-613-996-6666).

If a contracted vacuum truck or tank truck is used, give the driver a copy of the shipping documents [CAN] or manifests [USA] and SDS.

Trucks used to transport hazardous materials shall have a current copy of the *Emergency Response Guidebook* in the cab of the vehicle.

All transported hazardous materials shall be properly labeled in accordance with TDG or HAZMAT.

In the USA, manifests are not required when transporting materials of trade on a single motor vehicle and not exceeding 440 lb., such as:

- Up to 1 lb. or 1 pt.-size of Packing Group I material in a container;
- Up to 66 lb. or 8 gal of Packing Group II, III or ORM-D;
- Up to 400 gal of diluted (not over 2%) Class 9 material; and
- Cylinders (no larger than 220 lb. capacity) of Class 2.1 or 2.2 material.

### **6.2 COMPRESSED GAS CYLINDERS**

Compressed gas cylinders shall:

- Have connection points free of debris before attaching cylinders, hoses, valves, regulators or other fittings;

- Be legibly marked, by stenciling, stamping or labeling with either the chemical or trade name of the gas; the markings shall not be easily removable;
- Have cylinder valves closed and have shipping caps in place when the cylinder is not in use;
- Have only one key or handle for each manifold in multiple cylinder installations; and
- Not be exposed to extremely high temperatures (above 52°C or 125°F).

Contact the supplier if any part of the cylinder or attachments is not working properly.

Do not force valves or tamper with safety features on compressed gas cylinders.

Segregate flammable gases and compressed oxygen, and as per applicable legislation

Ensure “NO SMOKING” and other applicable signage is posted in the area entrances, or as required by applicable legislation

When in use, compressed gas cylinders shall:

- Be secured with non-combustible materials or means;
- Have fixed hand wheels, unless they have keys, handles or non-adjustable wrenches on valve stems;
- Use only appropriate torch and regulator valves to control the flow of gas;
- Not be brought into enclosures/hoardings, and shall be kept outside with a hose run into the enclosure/hoarding if the cylinder contains flammable gas or nitrogen; and
- Ensure that a flashback device is installed (as per manufacturer’s specifications) and that a back-flow prevention device is installed at the torch end, when gas-welding, cutting equipment or torches are used.

Gauges, regulators and fittings shall:

- Be bled down upon completion of work;
- Have the valve closed and all pressure released prior to being removed;
- Be disconnected when the cylinder is not in use;
- Have the regulator pressure-adjusting screw fully released prior to attachment; and
- Have broken gauge lenses replaced prior to use.

In addition to the above, oxygen cylinder gauges, regulators and fittings shall:

- Have a fully open valve when in use to prevent leakage around the stem;
- Not be used with oil or grease as a lubricant on regulators as it may cause an explosion; and

- Be marked “USE NO OIL”.

### **6.2.1 COMPRESSED GAS CYLINDER STORAGE**

Indoor storage practices for compressed gas cylinders shall be in accordance with applicable legislation including fire and building codes and the following requirements shall be met:

- Vented room with air exchange;
- Explosion proof lighting;
- Properly rated fire walls separating the storage space from other nearby spaces/areas;
- Storage room shall have at least one exterior wall along an outside wall in a space;
- Storage room shall be located away from machinery;
- Flammable gas shall be stored outdoors unless specific fire code, and requirements and manufacturer’s specifications are met; and
- Ensure “NO SMOKING” and other applicable signage is posted in the area entrances and as required by applicable legislation.

When stored, cylinders shall be:

- Placed up-right (unless the cylinder contains a non-flammable gas which is designed to be stored on their side);
- Away from sources of heat;
- Placed In a storage area at least 1.5 m (5 ft.) from building (if in an outdoor storage unit);
- Secured with non-combustible materials (preferably chained);
- Located in a dry, well-protected, well-ventilated location; and
- Placed at least 6 m (20 ft.) from highly combustible materials or separated by a fire-resistant barrier no shorter than 1.5 m (5 ft.) with a 30 minute fire rating.

All flammable gases and compressed oxygen shall be separated from each other and reference applicable legislation for additional requirements.

### **6.2.2 COMPRESSED GAS CYLINDER TRANSPORT**

During transport, compressed gas cylinders shall:

- Be secured;
- Have shipping caps in place;
- Be transported on hand trucks designed for the task; and
- Not be dragged, rolled or slid.

Compressed gas cylinders being hoisted shall:

- Be secured on a cradle, cage, sling board; and
- Not be hoisted or transported by means of magnets or choker slings.

Compressed gas cylinders mounted on portable welding units shall:

- Have acetylene secured in the upright position;
- Have oxygen and nitrogen secured in either vertical or horizontal position as required by applicable legislation;
- Have valves closed and protective caps in place when not in use; and
- Have mounting arrangements that hold the cylinder securely in the event of a rollover or other traffic event.

### **6.2.3 AEROSOL CANS**

Aerosols shall be:

- Kept under cover and protected from exposure to the weather and direct sunlight when being used intermittently for work (e.g., air horn);
- Kept at least 3 m (10 ft.) from any source of heat or ignition; and
- Secured in a flammable storage cabinet when stored.

### **6.3 PROPANE BOTTLES AND ACCESSORIES**

Do not use the valve to regulate the flow of propane. Ensure that the valve is either fully closed or fully opened.

Store propane bottles as follows:

- Outdoors on concrete or other non-combustible platforms;
- In an area that provides protection from tampering;
- In an area free of vehicle or mobile equipment travel; if propane bottles are required to be temporarily stored in areas where vehicle traffic is expected, then they shall be protected by barriers;
- Away from a fire escape, stairs or building egress;
- At least 7.5 m (23 ft.) away from buildings, unless in an approved storage cabinet; if using an approved storage cabinet, then store 1 m (3 ft.) away from buildings and 3 m (9 ft.) away from air intakes;
- At least 1 m (3 ft.) from other flammable compressed gas containers (e.g. acetylene); and

- At least 6 m (20 ft.) from containers or dispensers for flammable liquids and combustible liquids (e.g., gasoline and diesel fuel), or cylinders of compressed oxygen.

## **6.4 LEAKS AND SPILLS**

Contact the Environmental representative to assist with any spill, leak or potential contamination by hazardous materials. Refer to the Waste Management Plan for information on proper disposal of hazardous material.

## **7.0 TRAINING REQUIREMENTS**

Personnel working in the field must be knowledgeable in this Standard and may be assigned applicable training as driven by the Safety Training Matrix.

Reference the Health & Safety training syllabi and matrices for further information and training re-certification requirements.

## **8.0 RELATED DOCUMENTS**

Book 1 - Event Reporting - Canada

Book 1 – Event Reporting – USA

Waste Management Plan

## **9.0 STANDARD REVIEW**

A subject matter expert (SME) will perform a technical review of this standard every two years to determine the accuracy of the content/information. The SME shall solicit input from applicable stakeholders to ensure the effectiveness of the standard. Any suggested changes must be reviewed and approved by the designated document owner.

## **10.0 REFERENCES**

Alberta Fire Code

Emergency Response Guidebook

National Fire Code of Canada

OSHA 1910 Subpart H

OSHA 1910 Subpart Q

OSHA 1926 Subpart D

OSHA 1926 Subpart F

OSHA 1926 Subpart J

OSHA [https://www.osha.gov/SLTC/trucking\\_industry/transportinghazardousmaterials.html](https://www.osha.gov/SLTC/trucking_industry/transportinghazardousmaterials.html)

Transportation of Dangerous Goods <https://www.tc.gc.ca/eng/tdg/safety-menu.htm>





---

## CHANGE LOG

	Version 1.3	Version 1.4
Entire document		Clerical corrections including spelling, grammar, and document names.
6.2.2, 8.0		Updated terminology from incident and investigation to event and analysis.

<End of Document>



# Standard

---

## Tools & Equipment

---

**Effective Date:** 2019-03-30  
**Version #:** 2.1  
**Version Date:** 2024-03-27

---



This page intentionally left blank



**Document Version Register**

Version Number	Version Date	Approved By	Section Number and Title	Details of Version
1.0	2019-03-30	Sean Evans	Whole Document (New Standard)	This is the new H&S standard that was developed as part of the LP   MP Safety Manual Transition Project
1.1	2019-10-31	Sean Evans	6.4.2.1, 6.6	See change log
1.2	2020-06-01	Sean Evans	2.0	Alignment with Contractor Safety Specifications
1.3	2021-12-01	Murray Evenson	9.0, 10.0	Updated section 9 to reflect the appropriate review process Updated references in section 10.0
2.0	2023-09-21	Jeff Safioles	6.1, 6.4.1, 6.4.2.1, 6.5, 6.6, 6.7.3, 6.7.6	See Change log at the end of this standard.
2.1	2024-03-27	Troy Croft	All sections	Clerical corrections

Uncontrolled Copy if Printed or Downloaded



This page intentionally left blank



---

## Table of Contents

1.0	Purpose .....	3
2.0	Scope .....	3
3.0	Prerequisites.....	3
4.0	Definitions & Acronyms .....	3
5.0	Roles & Responsibilities .....	4
6.0	Standard-Specific Requirements .....	5
6.1	Tools and Equipment Use, Maintenance and Inspection Requirements .....	5
6.2	Tools and Equipment Guarding Requirements .....	5
6.2.1	Shear Points and Rotating Parts .....	6
6.3	Tools and Equipment Out of Service Requirements .....	6
6.4	Hand Tools .....	6
6.4.1	Open Bladed Knives .....	6
6.4.2	Power Tools Requirements (Portable Cord-and-Plug Connected Electric Equipment) .....	7
6.4.3	Explosive Actuated Tools .....	9
6.5	Post Pounders .....	9
6.6	Ladders.....	9
6.7	Equipment.....	10
6.7.1	Electric Equipment.....	10
6.7.2	Fuel -Operated Tools.....	11
6.7.3	Air-Operated Tools and Equipment .....	11
6.7.4	High Pressure Water Jetting Equipment .....	12
6.7.5	HydroVac Equipment.....	13
6.7.6	Abrasive Blasting Equipment.....	14
6.7.7	Portable Heaters .....	15
6.8	Brush Cutting and Vegetation Management .....	16



---

7.0	Training Requirements .....	16
8.0	Related Documents .....	16
9.0	Standard Review .....	17
10.0	References .....	17
11.0	Appendix A—PPE Requirements.....	18
	Change Log.....	20

## 1.0 PURPOSE

The purpose of the Standard is to ensure that Enbridge employees and contractors are using tools and equipment in the appropriate way which will ensure their safety.

## 2.0 SCOPE

This standard applies to LP Operations and Projects being completed for LP.

Contractors and subcontractors shall comply with Enbridge health and safety requirements set out in this standard, as articulated within applicable contractor safety specifications.

If a contractor or subcontractor has a health and safety standard or policy materially different from Enbridge's, the contractor/subcontractor shall follow the most stringent requirement. Contractors and subcontractors are still obligated to meet the requirements of all applicable laws related to this standard.

In the event a contractor's or subcontractor's standard exceeds the requirements of this standard, Enbridge may, in its sole discretion, choose to adopt the contractor's or subcontractor's standard for any given contract or work order.

## 3.0 PREREQUISITES

Atmospheric Monitoring Standard

Electrical Safety Standard

Flagging & Warning Signs Standard

Hazard Assessment and Control Standard

Hot Work & Ignition Sources Standard

Inspection Standard

Safe Work Permit & Work Authorization Standard

## 4.0 DEFINITIONS & ACRONYMS

*Adaptor cord*—used to accommodate an explosion proof fitting to a regular flexible power cord.

*Flexible power cords*—power cords, extension cords, etc.

*FLHA* - Field Level Hazard Assessment

*GFCI* – Ground Fault Circuit Interrupter



*Open blade knife*—is a cutting tool with an exposed blade, hand-held or otherwise, with or without a handle. It does not include handheld saws, grinders or other power tools that may be used for cutting purposes.

*PPE*—Personal Protective Equipment

*Qualified Electrical Worker*—one who has demonstrated skills and knowledge related to the construction, operation and maintenance of electrical equipment and installations. Depending on jurisdiction, may have to be a certified Journeyman Electrician.

*Qualified*—one who, by possession of a recognized degree, certificate, or professional standing, or who, by knowledge, training and experience, has successfully demonstrated his ability to solve or resolve problems relating to the subject matter, the work, or the project.

## 5.0 ROLES & RESPONSIBILITIES

People leaders shall ensure:

- Tools and equipment provided to workers are approved for use (where required) and in good condition for the work,
- Inherent hazards and safety features associated with the use of tools and equipment are assessed when selecting for purchase (e.g., ergonomics, noise, guarding, automatic shut off, dual trigger, etc.),
- Workers have the appropriate training to use the tools and equipment appropriately prior to use,
- Workers are aware of the hazards and associated controls when using tools and equipment,
- Workers are wearing appropriate PPE as required when using the tools and equipment, and
- Workers use the proper tool for the work task and that the tool or equipment is used for its intended purpose.

Workers shall:

- Inspect tools or equipment prior to use (document if applicable),
- Maintain and use tools and equipment appropriately,
- Report any defect or issue to the people leader and tag the tool or equipment out of use (e.g., “Do Not Use” or “Do Not Operate”),
- Complete required training on tools and equipment prior to use (when applicable),
- Be aware of any hazards associated to the use of the tools or equipment and the means of controlling those hazards,
- Wear appropriate PPE,
- Use the tool or equipment for its intended purpose and in accordance with the manufacturer’s specifications,

- Use the best tool or equipment for the task—consider ergonomics, congestion, weather, and available safety features, and
- Ensure when using a tool or piece of equipment when working with other workers that positioning is communicated, and situational awareness is maintained at all times.

## 6.0 STANDARD-SPECIFIC REQUIREMENTS

Enbridge recognizes the potential for hazards in working with tools, equipment or power tools and requires all employees to put the appropriate risk control methods in place, in adherence to this standard, to eliminate or mitigate the potential hazards.

### 6.1 TOOLS AND EQUIPMENT USE, MAINTENANCE AND INSPECTION REQUIREMENTS

All tools, equipment, and power tools shall be:

- Locked out (if applicable) or unplugged to isolate hazardous energy prior to servicing, maintaining or inspecting,
- Inspected, maintained and used according to Enbridge requirements, manufacturer's specifications and applicable legislation,
- Used for their intended and approved purposes only,
- Tagged out "Do Not Operate" and removed from service if found to be defective or malfunctioning and reported to people leader, and
- Operated in accordance with the manufacturer's weather and temperature limitations (review prior to use in extreme weather conditions).

Maintenance activities on tools, equipment and power tools shall be:

- Completed by Qualified workers, and
- Returned to a manufacturer-approved centre for service, repair, calibration or adjustment at the required intervals.

All Contractor tools, equipment, and power tools dispatched to an Enbridge location shall:

- Be in good working order, and
- Have the relevant operation, inspections, testing and maintenance records, plus maintenance instructions available upon request.

### 6.2 TOOLS AND EQUIPMENT GUARDING REQUIREMENTS

Guards shall be used to protect workers from hazards created by point of operation, rotating parts, flying chips, or other hazards.

Guards and protection (e.g., protective devices) shall:

- Meet manufacturer's specifications and applicable legislation,
- Be in good working order and inspected regularly,

- Not be modified or removed,
- Be replaced if damaged,
- Be the correct size,
- Be secure and tamper-proof, and
- Prevent falling objects (if applicable).

When broken guarding is removed, temporary guarding that meets manufacturer's standards can be used, but original equipment manufacturer (OEM) guarding must be in place as a permanent repair.

*Note: Always use push sticks, guards, shields or other devices as appropriate to avoid putting your fingers in pinch points.*

### 6.2.1 SHEAR POINTS AND ROTATING PARTS

Shear points and cut points shall be:

- Guarded in a manner that encloses the points within the machinery or equipment, or
- Otherwise guarded to prevent the operator from being exposed to the hazard.

Around rotating parts, workers shall not wear loose-fitting garments or jewelry. Workers with long hair shall keep their hair tied back to avoid entanglement.

### 6.3 TOOLS AND EQUIPMENT OUT OF SERVICE REQUIREMENTS

Any and all equipment that is not suitable for use (e.g., defective, guards removed, modified, damaged) shall be:

- Removed from service and disposed of or submitted for repair,
- Tagged out with 'DO NOT OPERATE',
- Tagged with the name of person removing from service, and
- Tagged with the date removed from service.

### 6.4 HAND TOOLS

All hand tools shall be:

- Inspected according to manufacturer's specifications prior to use,
- Used and maintained in accordance with manufacturer's specifications, and
- Tagged and removed from use whenever damaged or not suitable for use.

#### 6.4.1 OPEN BLADED KNIVES

Open bladed knives shall only be used when alternate tools are not reasonably practicable to complete the task.

When it is determined that an open bladed knife is the only tool that can be used to complete a task, the following criteria shall be met:

- PPE is worn at all times when using open bladed knives to cut large sections of material (i.e., dexterity may be required for smaller gauge wire stripping, nylon banding, etc.);
- Material being cut is secure;
- Only fixed blades are used and identified in the FLHA;
- Working space is appropriate to the task and allows the worker to work with the open bladed knife in a safe manner without endangering themselves or others, and
- Worker uses the knife to cut away from their body.

#### **6.4.2 POWER TOOLS REQUIREMENTS (PORTABLE CORD-AND-PLUG CONNECTED ELECTRIC EQUIPMENT)**

Enbridge recognizes that equipment and power tools have inherent hazards associated to their operation and require practices specific to mitigate those hazards.

##### **6.4.2.1 POWER TOOLS AND FLEXIBLE POWER CORDS:**

Adaptor cords (non-explosion proof) shall be:

- Under 3' in length and equipped with built in Ground Fault Circuit Interrupter (GFCI) protection,
- Uniquely identified for tracking purposes,
- Controlled and tracked by Enbridge field operations (typically, but not limited to, the electrical maintenance group) using Non-Explosion Proof Adapter Cord Log Sheet,
- Issued by Enbridge field operations, and identified on a field level hazard assessment (FLHA),
- Fabricated by a qualified electrical worker,
- Allowed in areas identified as hazardous on the "Site Safety Plot Plan," if all of the following conditions are met:
  - Area of intended use is identified on the sign out sheet,
  - Cord is never left unattended and is returned to the designated storage area after use,
  - Safe lower explosive limit (LEL) levels are verified prior to utilization, and
  - 100% area and/or personal gas detection is in effect.

Electrical extension cords shall be:

- Rated for extra hard usage (i.e., SOOW S- service, OO – Oil resistant insulation and jacket, W- weather resistant -) and the rating must be visible,
- Only used as a temporary power source,

- 3-wire type,
- "W" rated if being used outside,
- Immediately removed from service and tagged deficient if physically damaged, modified, or sub-standard (e.g., outer jacket cut, prong missing, or an under rated equipment cord),
- Assembled or repaired only by a qualified electrical worker (including adaptor cords),
- Routed in such a way as to:
  - Keep cord connections out of water,
  - Prevent any tripping hazard,
  - Avoid mechanical damage, and
  - Use only temporary means when attaching cords to structures (e.g., cable ties, electrical tape, barricade tape, etc.).

GFCI protection must be used when:

- Operating portable electrical tools or equipment outdoors,
- Operating portable electrical tools or equipment indoors where water, moisture or wet conditions are encountered,
- Using a non-explosion proof style adaptor cord,
- Using an extension cord with a receptacle (not just a plug) at one end, or
- Power is being supplied by a receptacle on a generator, welder, lighting plant inverter or other temporary power source.

Before using a GFCI it shall be function tested by pushing the TEST and RESET buttons.

When working with power tools, workers shall:

- Unplug the tool prior to attaching or removing bits, blades or other accessories, and
- Ensure all tools and equipment are set to the "off" position prior to plugging them in.

#### 6.4.2.2 GRINDERS AND BUFFERS

Workers using hand-held grinders and buffers shall:

- Ensure that sparks and debris are controlled,
- Unplug the tool when changing wheels or guards,
- Inspect the grinder to ensure it is in safe operating condition and that the wheel is free of cracks and other defects,
- Ensure the disc is the correct size and type for the grinder and is approved for more revolutions per minute than the grinder,
- Ensure all components are properly secured and in place,
- Ensure there is no locking switch (these are prohibited), and
- Ensure the dead man switch has not been modified to prevent proper operation.

See Appendix A for PPE requirements.

### 6.4.3 EXPLOSIVE ACTUATED TOOLS

If an explosive actuated tool is to be used, the Enbridge representative shall be advised prior to use.

Workers shall:

- Be qualified in the use of explosive actuated tools,
- Have training records available,
- Adhere to hot work requirements when using explosive actuated tools, and
- Dispose of live power shot load(s) appropriately.

### 6.5 POST POUNDERS

Any work involving post pounders shall have a Job Hazard Assessment for its use. Refer to *Ground Disturbance Standard* for additional guidance.

The manual post pounder design shall:

- Address the risk to the worker from the pounder coming off of the post, and
- Include effective ergonomic principals promoting ideal body positioning (i.e., longer post pounder).

If practical, use mechanical means such as slide hammers or air actuated hammers to reduce the potential for improper body positioning risk to the worker.

### 6.6 LADDERS

Ladders shall:

- Be used as per manufacturer's specifications,
- Be visually inspected before each use for any cracks or defects; if defective, tag and remove from service,
- Be carried horizontally below shoulder level,
- Have the proper weight rating for the task,
- Not be erected on boxes, carts, tables, or other unstable surfaces, and
- Be inspected periodically and after any occurrence which could affect their safe use.

Workers using ladders shall:

- Always face the ladder when going up, down or performing any work activity,
- Maintain three-point contact at all times when climbing or descending,
- Ensure the ladder's feet are placed on a firm and level base,

- Use Fall Protection when working from a ladder rung at a height of 1.83 m (6 ft.) or higher,
- Use only non-conductive side rail ladders unless in greenfield locations with Enbridge representative approval,
- Not straddle the space between a ladder and another object,
- Prevent foot traffic from entering the area where the ladder is located as per hazard assessment,
- Ensure that all articles that impede the ability for three points of contact with the ladder are lifted by another means,
- Lift or lower larger articles from elevated locations by a hand line or a hoist,
- Have ladders above 1.83m (6 ft.) held by a second worker when it is not secured, and
- Secure ladders at the base, when a kick-out hazard exists.

Step ladders shall:

- Be placed at right angles to the work,
- Not be used to brace or support work, and
- Not have either of the top two steps used for footing.

Extension ladders shall:

- Have the base of the ladder placed at an operating angle of 4 feet of rise to 1 foot out at the base,
- Extend at least 1 m (3 ft.) above the landing platform,
- Be tied off at the top of the ladder to prevent it from slipping or being moved or blown over,
- Have slip-resistant footing and rungs,
- Be climbed in accordance with the information included on the ladder label for usage and manufacturer's specification,
- Have the locking ladder hooks secure before climbing, and
- Not have the last three rungs from the top of the ladder used for footing.

## **6.7 EQUIPMENT**

### **6.7.1 ELECTRIC EQUIPMENT**

When working with electric equipment, workers shall follow these requirements:

- Portable electric equipment is grounded or double insulated,
- Unattended temporary electrical equipment (such as lights, heaters, etc.) that will be left on in a Class 1, Div. 2 or Zone 2 area must follow the requirements of the CEC Part I or NFPA 70 standards, and

- Portable generators used on the worksite shall be grounded, in accordance with manufacturer's specifications.

Only Qualified Electrical Workers can:

- Inspect or repair defective portable electrical equipment,
- Install temporary wiring for a temporary power supply (e.g., where needed for portable electrical tools, equipment, and lighting units), and
- Specify and install temporary power systems as per the requirements of the Electrical Safety Standard.

## **6.7.2 FUEL-OPERATED TOOLS**

Hazardous energy shall be controlled prior to performing maintenance on fuel-operated tools e.g., chainsaws and brush cutters.

Workers using fuel operated tools shall:

- Be qualified and competent in the operation of the specific tool,
- Meet legislated and/ or company-specific training and certification requirements (where required), and
- Wear required PPE, in accordance with the hazard assessment.

### **6.7.2.1 CHAINSAW OPERATION**

When using chainsaws, all operators shall have access to an appropriate personal first aid kit, spill kit and fire extinguisher. In addition, they shall have an effective means of communication for summoning assistance when required.

See Appendix A for additional requirements.

## **6.7.3 AIR-OPERATED TOOLS AND EQUIPMENT**

Workers using air-operated tools shall:

- Set the air supply properly for the tool being used,
- Ensure that air is drained from the line prior to disconnecting tools when not using a quick connect tool,
- Never use air-operated tool for cleaning workers or clothing,
- Use safety nozzles, plus effective chip guarding on applicable tools,
- Ensure air-operated tools do not exceed 30 psi when cleaning equipment or floors,
- Not adjust the compressor to operate above the manufacturer's specified rating,
- Be qualified on the brand/ model of equipment they're using to operate all equipment with brand/model specific attachments including quick connect couplers, and
- Ensure that the installation of the quick coupler itself is performed according to the manufacturer's specifications.



Workers using impact wrenches shall:

- Ensure directional lever is in the correct position prior to loosening or tightening a bolt or nut (refer to the manufacturer's specifications for appropriate means of attaching a socket to a larger impact wrench when a locking mechanism is required), and
- Ensure everyone's hands remain clear of pinch points such as the area around socket or reaction arm.

Pneumatic hoses shall:

- Be appropriately rated for the maximum pressure produced in systems,
- Have excess flow valves or chokes installed on all airlines at the compressor or header to prevent high-volume air release,
- Have temporary and quick connections secured using whip checks on all connection points,
- Have safety pins where the connection point is designed for their use,
- Have safety clips or retainers used at the attachment point on pneumatic impact percussion tools,
- Be protected from tangles, unnecessary wear and damage, and
- Have a safety device at the source of supply or a branch line to reduce pressure in case of hose failure for all hoses exceeding ½-inch inside diameter.

#### 6.7.4 HIGH PRESSURE WATER JETTING EQUIPMENT

All water-based cleaning operations conducted at pressures of 5,000 psi or more or which develop more than 22 ft. lbs. of force shall be considered high pressure water jetting (HPWJ). Pressure washing shall be defined as water-based cleaning operating at less than <5,000 psi and producing no more than 22 ft. lbs. of force.

Only qualified workers (min. two) shall complete HPWJ activities and follow appropriate work procedures.

When conducting high pressure water jetting, the workers shall ensure:

- Equipment operator nearest the high-pressure nozzle can immediately reduce pressure or interrupt the flow to the nozzle,
- At least one control valve or switch controls each high-pressure tool,
- A worker operates only one high-pressure lance, mole or shotgun at one time,
- High-pressure cleaning hose is positioned and handled to minimize bends and turns,
- High-pressure hose connections shall have whip checks and connections properly secured,

- When cleaning piping systems:
  - Open access is provided at least every 30 m (100 ft.), and
  - Flanged elbows or spool sections of pipe are removed,
- System is depressurized when:
  - Not in use,
  - Unauthorized or inadequately protected workers enter the work area,
  - Replacement or repairs are made to the equipment, including tightening or loosening fittings, and
  - Recommended practices are violated.

See Appendix A for additional requirements.

### 6.7.5 HYDROVAC EQUIPMENT

Hydrovacating equipment shall include:

- Hoses, fittings and attachments rated and designed for the maximum specified operating pressures of the equipment,
- Systems capable of constant monitoring of temperature and pressure to ensure that allowed operating limits are not exceeded,
- Wand tips designed to prevent a concentrated water stream,
- Wands of sufficient length to prevent the operator from contacting the wand tip while the wand is in operation,
- A relief system capable of relieving the full capacity of the pump at maximum rpm (to protect the weakest component in the system),
- A shut-off valve on the wand or a water shut-off switch on a remote control that is manned by a second worker,
- Restraining devices on couplings to prevent accidental disconnection (where couplings provide for such devices), and
- A neoprene or equivalent lip on the vacuum tube end to eliminate any mechanical damage to the facility.

Due to static electricity, ground the vacuum excavating system during operations.

Equipment must be operated within manufacturer's specifications and applicable regulations at all times.

The working water pressure must not exceed 17,250 kPa (2500 psi). When excavating within 0.3 meters (1 ft.) of known or suspected underground facilities, the pressure must be reduced to less than 10,350 kPa (1500 psi) and the water temperature limited to 38° C (100° F).

## 6.7.6 ABRASIVE BLASTING EQUIPMENT

Abrasive blasting shall only be completed by qualified workers and shall follow the appropriate work procedures when conducting the work.

Workers using abrasive blasting equipment shall:

- Post warning signs within 15 m (50 ft) of the work area and erect barricades or flagging as required,
- Test safety shutdown and control (deadman) switches daily,
- Prior to daily use, visually inspect equipment,
- Use intrinsically safe switches and complete atmospheric monitoring when applicable, or as determined by the hazard assessment,
- Have whip checks, clips and wires properly installed on hoses to prevent accidental decoupling,
- Have a worker rotation plan in place when performing abrasive blasting for extending periods to reduce exposure time,
- Implement dust control measures as required,
- Ensure fresh air supply systems are inspected and calibrated within six months of use, and
- Control the end of the blast hose to protect themselves and co-workers.

The blast nozzle control (deadman) switch shall:

- Be located near the nozzle in a position where the operator's hands will be when using the device,
- Not be disabled for any reason,
- Immediately stop the flow of material when released,
- Be guarded, to prevent accidental activation.

Abrasive blasting equipment used to clean tanks shall:

- Have the blasting hose nozzle bonded electrically to the tank shell or the tank roof if the blast nozzle(s) are conductive.

Abrasive blasting within 3 m (10 ft.) of any tank vent— whether or not the vents are open— is not allowed, unless the tank has been cleaned and declared gas free by a qualified worker; if a tank has not been cleaned and declared gas free, clean areas within 3 m (10 ft.) of tank vents with hand tools such as scrapers, wire brushes and similar equipment.

If abrasive blasting operations occur on NGL lines, then they shall adhere to requirements as outlined within OMMs B3\_05-01-01 "NGL Abrasive Blasting".

*Exception: Abrasive blasting of external floating tank roofs may be performed in accordance with API RP 2027 and approval of the Enbridge Operations representative.*

See Appendix A for additional requirements.

### 6.7.7 PORTABLE HEATERS

All portable heaters shall:

- Be properly grounded and plugged into a GFCI when electric (if required),
- Be attended when in operation based on hazard assessment requirements,
- Not be placed on or near combustible or flammable materials or surfaces, and
- Be in proximity to a readily available fire extinguisher,
- Be used in accordance with the manufacturer's specifications, and
- Have initial and continuous atmospheric monitoring when placed in a Class 1, Div. 2 or Zone 2 area.

Portable fuel heaters shall:

- Be operated only where there is adequate ventilation,
- Be placed outside of the enclosed or confined space away from openings, along with the fuel, and
- Have ongoing atmospheric monitoring when heated air is being introduced to enclosed spaces occupied by workers.

All diesel-powered portable heaters shall follow the Enbridge *Positive Air Shut Off* requirements.

Portable catalytic heaters shall:

- Be approved for use in an explosive or hazardous atmosphere; approval shall be from an applicable, recognized authority such as the Canadian Gas Association (CAN) or American Gas Association (USA),
- Have continuous monitoring when used in an explosive or hazardous atmosphere,
- Have adequate ventilation to prevent a build-up of exhaust fumes and to prevent the fumes from being drawn through the heater and into the space being heated,
- Have carbon monoxide monitors when required,
- Have only explosion-proof electrical fittings attached,
- Have a regulator between the propane bottle and the heater to reduce the pressure of gas to the heater, to a level specified by the manufacturer,
- Have a thermostatic block valve installed on the propane line where it enters the heater,
- Not be used in electrical enclosures where there are open relays, and
- Be used only in accordance with manufacturer's specifications.

## 6.8 BRUSH CUTTING AND VEGETATION MANAGEMENT

When using motorized equipment for cutting or clearing brush, workers shall:

- check the cutting area for any metal, large stones or other hard material that could damage the blades or cutter disc,
- regularly clean accumulated debris from the top of the cutter's fuel tank and from the engine, pumps, and axle protection plates on a regular basis,
- ensure other workers do not approach the brush cutter's articulating joint when the brush cutter is operating,
- operate brush cutters with protective guards installed,
- wear additional PPE as required by the Hazard Assessment,
- ensure each brush cutter has protective guards and only operate brush cutters with the guards installed, and
- dispose of brush and slash by mulching and spreading on an area designated by the regional/project manager or an Enbridge ROW agent or landowner.

A worker shall not operate a brush cutter when other workers are within 150 m (500 ft.) of the front or sides of the brush cutter (see manufacturer's recommendations).

Brush cutting is a Ground Disturbance activity when it meets the criteria in the Ground Disturbance definition. Ground Disturbance precautions shall be in place prior to beginning brush cutting.

When overhead clearing of vegetation is being completed, all applicable precautions will be implemented. If clearing is required within the limited approach boundary to overhead powerlines, a certified and / or licensed professional arborist will be utilized to perform the work. Refer to the Safe Limits of Approach & Entry Safety Standard.

## 7.0 TRAINING REQUIREMENTS

Personnel working in the field must be knowledgeable in this Standard and may be assigned applicable training as driven by the Safety Training Matrix.

Reference the Health & Safety training syllabi and matrices for further information and training re-certification requirements.

## 8.0 RELATED DOCUMENTS

OMMs B3\_05-01-01 "NGL Abrasive Blasting"

Ground Disturbance Standard

## 9.0 STANDARD REVIEW

A subject matter expert (SME) will perform a technical review of this standard every two years to determine the accuracy of the content/information. The SME shall solicit input from applicable stakeholders to ensure the effectiveness of the standard. Any suggested changes must be reviewed and approved by the designated document owner.

## 10.0 REFERENCES

### Occupational Safety and Health Administration (OSHA)

- Ladders, 29 CFR 1910.23
- Tools – Power-operated Hand Tools, 29 CFR 1926.302
- Guarding of Portable Powered Tools, 29 CFR 1910.243
- The Control of Hazardous Energy (Lockout/tagout), 29 CFR 1910.147
- Eye & Face Protection, 29 CFR 1910.133
- Head Protection, 29 CFR 1910.135
- Hand Protection, 29 CFR 1910.138

### Canada Labour Code, Part II; Canadian Occupational Health & Safety (COHS) Regulations

- Portable Ladders, 3.11
- Hearing Protection, 7.7
- Eye & Face Protection, 12.12
- Tools & Machinery, 13.1
- Operation & Use of Tools, 13.2
- Machine Guards, 13.13



## 11.0 APPENDIX A—PPE REQUIREMENTS

PPE					
(In addition to the minimum PPE required for all Enbridge Worksites)					
Work Activity	Eye, Face & Hearing	Hand	Body	Respiratory Protective Equipment	
				(These are the minimum requirements; a higher level of RPE may be required based on Atmospheric Monitoring)	
Abrasive Blasting	Abrasive blasting helmet or hood.	Leather or canvas gauntlet gloves.	Heavy duty blast suit or leather apron.	Blaster and helpers/workers in immediate vicinity of blasting: Type CE supplied air abrasive blasting respirator, hood or helmet with apron, operated in continuous flow mode.	
				Hearing protection.	Open Space
				Confined Space	Helpers and workers in the blast area same as Blaster.
Abrasive Blasting with Self-Contained System (e.g., Blastrac)	As per assessment of all potential and existing hazards.			Half-mask APR with P100 dust filter.	
Operating Chainsaws or Metal Blade Weed Trimmers	Full-face shield or impact-resistant	Leather gloves	Kevlar leg chaps or pants.		
	Hearing Protection		Footwear for chainsaw operation (CAN)		
Chipping, Hammering Metal, Sledge or Jack Hammering; or Using Compressed Air; or Operating Electric and/or Hand Saws; or Concrete Work	Full-face shield and/or impact goggles.	Leather or Kevlar gloves.	As per potential and existing hazards	As per potential and existing hazards. Consider type and quantity of particulates being generated.	



<b>PPE</b>				
(In addition to the minimum PPE required for all Enbridge Worksites)				
<b>Work Activity</b>	<b>Eye, Face &amp; Hearing</b>	<b>Hand</b>	<b>Body</b>	<b>Respiratory Protective Equipment</b> (These are the minimum requirements; a higher level of RPE may be required based on Atmospheric Monitoring)
Wire Brushing, Buffing, Cutting, Grinding (electric and pneumatic, including cut-off and concrete saws)	Welding helmet and safety glasses under helmet; or full-face shield or full-face shield and impact-resistant goggles.	Leather gauntlet-type gloves (with seams on the inside).	As per potential and existing hazards	As per potential or existing hazards.
	Hearing protection.			
High Pressure Water Jetting and pressure washing at 2000 psi or greater	Full-face shield	Heat and water resistant gloves- Minimum Cut level 4	Metatarsal protection, knee length with ribbed steel shanks and heavy tread soles for nonslip traction. Additional PPE may be required based on potential and existing hazards.	As required by potential or existing hazards.
	Hearing Protection			





---

## CHANGE LOG

Section	Version 2.0	Version 2.1
Entire document		Clerical corrections including spelling, grammar, and document names.

<End of Document>



---

# Standard

---

## Vehicle Operations

---

**Effective Date:** 2019-03-30

**Version #:** 2.2

**Version Date:** 2024-03-28

---



This page intentionally left blank



**Document Version Register**

Version Number	Version Date	Approved By	Section Number and Title	Details of Version
1.0	2019-03-30	Sean Evans	Whole Document (New Standard)	This is the new H&S Standard that was developed as part of the LP   MP Safety Manual Transition Project
1.1	2019-10-31	Sean Evans	5.0, 6.1	See change log
1.3	2021-04-01	Sean Evans	2.0	See change log
1.3	2021-08-01	Jeff Safioles	3.0, 4.0, 6.1.1, 6.2, 6.6, 6.7, 8.0, 9.0	See change log
1.4	2021-11-10	Jeff Safioles	6.4.4	See change log
1.5	2022-06-13	Murray Evenson	6.2.2	See change log
1.6	2023-01-05	Murray Evenson	5.0, 6.4.4	See change log
2.0	2023-04-18	Murray Evenson	5.0, 6.3, 6.3.1, 10.0	See change log
2.1	2023-12-07	Jeff Safioles	4.0, 6.3, 6.4.4	See change log
2.2	2024-03-28	Troy Croft	5.0, 4.7.1, 6.6.3, 6.7.1, 6.7.2, 6.7.4	See change log
			All sections	Clerical corrections.



This page intentionally left blank



---

## Table of Contents

1.0	Purpose .....	3
2.0	Scope .....	3
3.0	Prerequisite .....	3
4.0	Definitions & Acronyms .....	3
5.0	Roles & Responsibilities .....	5
6.0	Standard-Specific Requirements .....	6
6.1	General Requirements for Drivers .....	6
6.2	Vehicle Safety Check .....	7
6.2.1	Annual Inspections .....	7
6.2.2	Pre-use Walk-around .....	8
6.3	Distracted Driving and Use of Communication Devices .....	8
6.3.1	Distracted Driving Prevention .....	9
6.3.2	Safe Use of GPS Equipment .....	9
6.4	Vehicle Operation .....	9
6.4.1	Towing .....	10
6.4.2	Safe Use of Trailers and Hitches .....	11
6.4.3	Vehicle Fueling .....	11
6.4.4	All Terrain and Off-Highway Vehicles (OHVs) .....	12
6.5	Highway Vehicle Safety and Signage .....	13
6.5.1	Highway Vehicle Markings .....	13
6.6	Wheel & Tire Requirements .....	13
6.6.1	Maintenance Requirements .....	13
6.6.2	Purchasing Requirements .....	14
6.6.3	Changing a Tire .....	14
6.6.4	Wheel Nut Indicators .....	15
6.7	Telematics .....	15
6.7.1	Purpose of Telematics .....	15
6.7.2	Collection, Storage and Access to Telematics Data .....	17



---

6.7.3	Reporting .....	17
6.7.4	Privacy .....	18
7.0	Training.....	18
8.0	Related Documents.....	18
9.0	Standard Review .....	18
10.0	Appendix.....	19
	Annual Inspection Form.....	19
	Change Log.....	20

## 1.0 PURPOSE

The purpose of this standard is to ensure that Enbridge workforce and contractors are safe when operating vehicles at Enbridge locations.

## 2.0 SCOPE

This standard applies to LP Operations and Projects being completed for LP.

Contractors and subcontractors shall comply with Enbridge health and safety requirements set out in this standard as articulated within applicable contractor safety specifications. If a contractor or subcontractor has a health and safety standard or policy materially different from Enbridge's, the contractor/subcontractor shall follow the most stringent requirement. Contractors and subcontractors are still obligated to meet the requirements of all applicable laws related to this standard.

In the event a contractor's or subcontractor's standard exceeds the requirements of this standard, Enbridge may, in its sole discretion, choose to adopt the contractor's or subcontractor's standard for any given contract or work order.

Commercial Motor Vehicle requirements can be found in the Commercial Motor Vehicle Standard.

## 3.0 PREREQUISITE

### SUPPORTING H&S PROGRAMS

Directly Related to Hours of Service are key H&S program expectations. These expectations are found in the Environmental Conditions Standard and the Fatigue Management Standard. Expectations that should be understood and coordinated with operation of vehicles include:

- Complete Journey Management planning when required as outlined in the Environmental Conditions Standard (when workers are travelling more than 2 continuous hours).
- When applicable working alone practices should be implemented as outlined in the Environmental Conditions Standard
- Utilize or develop Fatigue Management plans when expecting hours of service could impact performance.

## 4.0 DEFINITIONS & ACRONYMS

*ATV* - All Terrain Vehicle (e.g., quad, 4-wheeler) with no rollover protection

*Communication Device* – Any portable computing or telecommunication device. Examples include, but are not limited to, cell phones and smartphones, tablets, mobile radios, and other similar devices, etc.

*DOT* - Department of Transportation



*Driver* – Employee or contractor who operates a vehicle for company business. Includes personal vehicle use for company business.

*Driver Improvement Plans (DIP)* - Strategies designed to correct at risk behaviors as defined/identified within the MVR and telematics reports.

*Fleet Driver/High Frequency* - Employee or Contractor who drives a vehicle for company on average once or more per week (50 or more times per year). Includes but not limited to:

- Commercial Drivers
- Transporters of hazardous materials
- Some drivers may have a lesser frequency. (Based upon nature of driving and determined by Fleet Safety or other.)
- Drivers in high traffic areas
- Van pool
- Extreme weather

*GPS* - Global Positioning System

*GVWR* – Gross Vehicle Weight Rating

*Highway vehicle* - A vehicle equipped with design features that enable it to be normally operated and to mix with regular traffic on public roads, including highways, streets, bridges, etc.

*HOS* - Hours of Service

*ICS* - Incident Command System

*MVR* – Motor Vehicle Record

*OEM* – Original Equipment Manufacturer

*Off-highway vehicle* - A vehicle designed primarily for recreational use or for the transportation of property or equipment exclusively on undeveloped road rights of way, marshland, open country, or other unprepared surfaces.

*Qualified* - One who, by possession of a recognized degree, certificate, or professional standing, or who by knowledge, training, and experience, has successfully demonstrated their ability to solve or resolve problems relating to the subject matter, the work, or the project.

*ROPS* - Rollover Protective Structure

*Telematics* - A system or technology used to collect vehicle information through satellites, cellular towers, or other data collection systems.

*UTV* – Utility Terrain Vehicle (e.g., side-by-side) with seatbelts and rollover protection

---

## 5.0 ROLES & RESPONSIBILITIES

People Leaders shall:

- Ensure all employees driving vehicles comply with this procedure;
- Not knowingly allow, require, permit, or authorize any employee whose license has been revoked, suspended, canceled, or disqualified to drive a motor vehicle until such license has been reinstated;
- Utilize Fatigue Management Standard to recognize and mitigate the risk of fatigue within their workforce;
- Consult with HR and Vehicle Fleet Safety to determine if driving conviction placed driver in a High-Risk category that could necessitate the need to complete a Driver Improvement Plan (DIP) or other disciplinary action(s). (DIP is primarily related to annual MVR reviews which covers each worker's three-year period immediately preceding the MVR.);
- Review telematics reports and address areas of concern related to the unsafe driving behaviors monitored by telematics. This includes but is not limited to the following:
  - Speeding
  - Harsh Braking
  - Harsh Acceleration
  - Harsh Cornering
  - Seat Belt Usage
- Ensure drivers receive drivers training as required.

Worker/drivers shall:

- Comply with Enbridge driving requirements (see prerequisites), policies and procedures;
- Comply with all other driving-related Enbridge policies and procedures (e.g., driver responsibilities, recordkeeping, conduct and discipline, drug and alcohol, distracted driving, material handling, and inspection standards);
- Utilize Fatigue Management Standard to recognize and mitigate the risk of fatigue for themselves and their co-workers;
- Adhere to applicable driving laws;
- Complete training in the use of required safety equipment (e.g., fire extinguishers, personal protective equipment, etc.);
- Operate vehicles in safe operating condition;
- Have the correct license in their possession when operating the vehicle (when applicable);
- Complete pre-use walks around inspection;

- Immediately report all motor vehicle events to their people leader;
- Drive slowly and with caution, as appropriate, e.g., when road or driving conditions are poor or hazardous and/or when workers or other people are present;
- Maintain vehicles according to manufacturer's specifications;
- Operate properly equipped and maintained vehicles; and
- Complete journey management plan when required as outlined in the Environmental Conditions Standard (when workers are travelling more than 2 continuous hours).

Co-op/Summer Students shall:

- Get approval to drive from their people leader;
- Limit driving as much as possible;
- Adhere to the responsibilities outlined for drivers;
- Have regular driver evaluations completed by their people leader;
- Drive vehicles no larger than  $\frac{3}{4}$  ton;
- Not tow trailers;
- Use UTVs (side-by-sides) in terminals whenever possible; and
- Only transport passengers if approved by their People Leader.

## **6.0 STANDARD-SPECIFIC REQUIREMENTS**

### **6.1 GENERAL REQUIREMENTS FOR DRIVERS**

When operating a vehicle, drivers shall:

- Ensure that the vehicle has current registration and insurance available in the vehicle.
- Properly use all the safety mechanisms installed on vehicles, including seat belts.
- Ensure that all vehicle occupants are always wearing their seat belts (when equipped) when the vehicle is in motion.
- Secure materials, tools and equipment against movement when stowed in the cabin of vehicle or erect barriers to safely separate workers from stowed items.
- Have headlights on when in operation.
- Ensure vehicles have all required safety accessories as listed in the Emergency Preparedness – Personal Safety Standard, including but not limited to:
  - Secured fire extinguisher
  - First aid kit
  - Roadside emergency kit

- Winter emergency kit (where applicable)
- Aerial whip and flag, where required (e.g., Mainline Construction)
- Ensure that only vehicles required for the completion of work activities are within the immediate worksite; all other vehicles shall be parked in approved areas.

All Enbridge owned or leased worksite workforce vehicles 1 ton and over shall have backup alarms installed that:

- Operate automatically when reverse is engaged; and
- Are clearly audible above background noise.

## **6.2 VEHICLE SAFETY CHECK**

### **6.2.1 ANNUAL INSPECTIONS**

At a minimum, Enbridge owned, and leased vehicles shall have an annual vehicle inspection conducted and documented (Commercial Vehicles will follow Commercial Motor Vehicle (CMV) standards). Drivers shall have multi-point inspections on vehicles completed as part of their regular maintenance by an authorized 3rd party maintenance facility/mechanic, unless otherwise approved/authorized by SCM Fleet (e.g., PLM workers in remote locations.) Annual inspection checks shall include the following:

- Auto trans fluid - check dipstick shows oil in operating range;
- Power steering fluid - check level;
- Brake fluid - check level;
- Coolant / antifreeze - check operating level at reservoir;
- Battery - connections tight, no visible corrosion;
- Spare tire - check air pressure;
- Windshield washer fluid - reservoir full;
- Vehicle documents (insurance, registration) - valid, in the vehicle;
- Licence plate - securely attached;
- Roadside emergency kit (see Emergency Preparedness – Personal Safety Standard);
- Back-up lights - confirm working;
- Rear licence plate lights - check operational;
- Tire pressure - use tire gauge, confirm pressure matches manufacturer's specs;
- Tire wear - use tread depth gauge; minimum 2 mm for summer tires, 4 mm for winter tires;
- Parking brake functional; and

- Steering - no excessive free play or worn components.

### **6.2.2 PRE-USE WALK-AROUND**

Workers and/or Drivers shall conduct a pre-use walk-around of the vehicle prior to use, verifying safe working condition of the vehicle.

Report defects to your immediate people leader/supervisor. Defects that cause that vehicle to be considered inoperable shall be immediately corrected.

Workers and/or Drivers shall conduct a walk-around prior to moving a vehicle to check for:

- Potential obstructions and approach distances;
- Fluid leaks;
- Vehicle damage;
- Clear visibility, including any damage or cracks to the windshield and rear/side windows;
- Adequate tire tread depth, cuts, scrapes, punctures, bulges, bumps or cracks and inflation pressure, as well any damage or conditions that would warrant tire replacement;
- Ensure loads are secured prior to movement;
- Ensure that side compartment doors on service body equipped vehicles are properly latched, and the “gang latch” or “master lock” is engaged prior to operating vehicle.

Report defects to your immediate people leader/supervisor. Defects that cause that vehicle to be considered inoperable (according to local applicable legislation) shall be immediately corrected.

### **6.3 DISTRACTED DRIVING AND USE OF COMMUNICATION DEVICES**

The operator of a vehicle is responsible for complying with any additional requirements set out in provincial/state or municipal legislation governing the use of communication devices.

All Enbridge personnel must follow the below requirements:

1. Any use of a personally owned communication device is strictly prohibited when operating an Enbridge owned, leased, or rented vehicle at any time or when operating a personal vehicle while conducting Enbridge business; and
2. Any use of an Enbridge owned communication device is strictly prohibited when operating any vehicle.

The operator of a vehicle shall only answer or make calls, read, or send text messages and email, or otherwise utilize the functionality of a communication device when the vehicle is legally parked in a safe location out of traffic.

Using a communication device as a GPS unit is acceptable if the use of it is following the requirements of section 6.3.2 and is not being used for other purposes.

### Emergency Response Exception

Exceptions to the above requirement will be made only when the operator of a vehicle:

1. is unable to pull over to safely park the vehicle;
2. is in active response to a known or suspected emergency that is:
  - a. not within the municipal boundaries of any city or town;
  - b. not on roads with significant traffic/congestion; and
  - c. not on roads in poor condition (e.g., ice, snow, mud, ruts, etc.).

Outgoing and incoming calls are allowed only in an emergency situation that meets the above criteria but are to be minimized in frequency and duration and the operator must utilize hands-free technology.

### 6.3.1 DISTRACTED DRIVING PREVENTION

All Enbridge personnel must activate distracted driving prevention features on phones where possible for both company-owned devices and personal mobile devices enrolled in the Bring Your Own Device program.

*Note: Exception - Activating distracted driving prevention features (e.g., Apple Focus or Android Driving) is not necessary if your role requires the use of your device (i.e., on-call, journey management, emergency response or working alone).*

### 6.3.2 SAFE USE OF GPS EQUIPMENT

When using a global positioning system (GPS) in a vehicle, workers shall ensure:

- The GPS unit is equipped with hands-free navigation and is turned on prior to driving;
- The GPS unit is properly affixed to the vehicle prior to driving:
  - Affix in a position to not obstruct view of the road;
  - Affix in a position to not obstruct view of vehicle instrumentation;
- The GPS is programmed prior to driving; and
- The vehicle is safely parked prior to making programming changes to the GPS unit.

## 6.4 VEHICLE OPERATION

Workers operating vehicles shall:

- Pull through a parking space when it is possible;
- Back into a space when safe to do so;

- Use a spotter/signaler (if available) to direct the vehicle when reversing or when line of sight is limited;
- Secure truck bed and trailer bed loads against movement;
- Have keys easily accessible so that the vehicle may be moved, if necessary, when required and the worksite is secure, e.g., due to site conditions or congestion, or in the event of an emergency;
- Never operate a vehicle with a person in the bed of the vehicle;
- Not allow any person on the bed of a truck during winching operations when stationary;
- Not operate a vehicle that is loaded in excess of maximum capacity;
- Honk prior to reversing when without back-up alarm;
- Park on working/right side of the roadway (if safe to do so) when parking on black top or gravel roadways;
- Maintain a 1 m (3 ft.) buffer zone around their vehicle (on each side, in front of, behind and above) except for curbs, spaces or facilities specifically intended for parking;
- Use a spotter/signaler (if available) to direct the vehicle where the 1 m (3 ft.) buffer zone cannot be maintained, and
- Not stop, park, or pass through the area without the equipment operator(s) acknowledging your presence; follow the directions of flag persons/traffic signals when present.

#### 6.4.1 TOWING

Whenever practicable, use a certified towing agency to recover a vehicle. If a towing agency is not used, follow these requirements when recovering a vehicle:

- Recovery straps shall be nylon, with sewn loops at each end and at least 6 m (20 ft.) in length;
- Use the vehicle recovery equipment in accordance with the manufacturer's specifications, e.g., do not exceed the pulling strength limits of the recovery straps; and
- Do not use lifting slings, snatch straps, chains or recovery straps manufactured with chain and hook attachments. Towing operations shall only be performed by qualified operators. All towing equipment shall adhere to the following requirements:
  - Vehicle recovery straps (tow ropes), including the attachment hardware, shall be labeled with their assigned strength and safety ratings;
  - Tow ropes and hardware shall be of adequate pulling strength to ensure the weight of the vehicle can be safely towed; and
  - Chains shall not be used for towing.

---

## 6.4.2 SAFE USE OF TRAILERS AND HITCHES

When using trailers and hitches, workers shall:

- Ensure hitch and receiver are compatible and correctly sized;
- Visually inspect trailers and hitches prior to each trip;
- Test signal and brake lights prior to departure;
- Test brakes (if applicable) prior to departure;
- Test and calibrate auxiliary brakes prior to departure; if equipped with breakaway cable, check the cable length, and ensure the coupling is fully plugged in;
- Use adequately sized tow chains that are securely fastened;
  - Chains and hooks must be properly sized / matched with trailers. The strength rating of each length of safety chain or its equivalent and its attachments shall be equal to or exceed, in minimum breaking force, the Gross Vehicle Weight Rating (GVWR) of the trailer.
- Cross the tow chains to prevent the hitch from contacting the ground if it becomes disconnected;
- Secure the coupling latch (e.g., pin, lock, bolt and nut) after coupling the trailer to the towing vehicle;
- Secure all loads; and
- Have the trailer ball-mount assembly removed from the receiver when not in use.

## 6.4.3 VEHICLE FUELING

When fueling vehicles, workers shall:

- Always shut off the vehicle before fueling;
- Never smoke near a fueling area or fuel station;
- Never smoke while fueling a vehicle;
- Never overfill a fuel tank;
- Never leave the fuel nozzle unattended;
- Never use a cellular device while fueling; and
- Always ensure the tank is bonded before fueling when fueling from an auxiliary fuel tank.



#### 6.4.4 ALL TERRAIN AND OFF-HIGHWAY VEHICLES (OHVs)

The use of all-terrain vehicles (ATVs) on Enbridge worksites is restricted unless authorized by the appropriate Vice President or Incident Commander (when ICS is enacted during a response). This requirement does NOT include utility terrain vehicles (UTVs) as defined.

- ATV – all terrain vehicle (e.g., quad, 4-wheeler) with no rollover protection
- UTV – utility terrain vehicle (e.g., side-by-side) with seatbelts and rollover protection

Workers operating ATVs, UTVs and snowmobiles shall be trained and qualified in their use and authorized to operate the land vehicle.

Operators shall:

- Wear Snell/DOT approved helmets;
- Wear appropriate PPE, e.g., protective goggles and/or other suitable devices to prevent eye and face injuries from twigs, flying debris and weather conditions;
- Not operate on a highway (crossing a highway is permitted);
- Receive permission prior to operation on private property; and
- Operate at speeds appropriate for the terrain, visibility, conditions, and experience.

Note: Within the fenced area of a facility, the maximum speed limit is 30 km/h or 18 mph unless the posted limit is lower.

Operators may wear a hardhat in place of a Snell/DOT approved helmet when driving on roads within Enbridge facility sites if the ATV/UTV is equipped with ROPS and a two-point (lap) seatbelt and while maintaining the posted speed limit.

All ATVs, UTVs and snowmobiles shall:

- Be equipped with functioning headlights and taillights;
- Have license plates securely attached in a visible location, as required by applicable legislation;
- Be equipped with a first aid kit, 5 lb. ABC fire extinguisher, and portable communication equipment (e.g., hand-held radio, cellular or satellite phone) as required;
- Be equipped with an aerial whip and flag when identified on a hazard assessment; and
- Be equipped with spark arrestors as required by applicable legislation.

UTVs and snowmobiles may only carry passengers when there is a passenger seat.

If the vehicle is designed for it, wear a properly adjusted and securely fastened seat belt assembly:

- Prior to the engine start;
- When occupying the vehicle while there is a risk of the vehicle becoming unstable; and

- While the vehicle is in motion

## **6.5 HIGHWAY VEHICLE SAFETY AND SIGNAGE**

### **6.5.1 HIGHWAY VEHICLE MARKINGS**

All Enbridge owned highway vehicles shall be marked as determined by regional/site management.

The following standard decals shall be affixed when required:

- First aid kit;
- Boosting battery (see vehicle owner's manual for boosting hybrid vehicles);
- Walk around your vehicle; and
- Fire extinguisher inside.

Reflective stripes on Enbridge Operations vehicle roofs are optional; their use is at the discretion of regional management. When used:

- Place reflective stripes diagonally, from left front to right rear; and
- Roof striping shall be red in color.

Enbridge owned vehicles and equipment licensed for highway use shall have reflective stripes placed in the rear of the vehicle, except for cars and vehicles designated as non-emergency response by regional/site management. Rear striping shall be red, alternating with white. Stripes shall be at least 5 cm (2 in.) wide.

Reflective stripes on the rear of truck tractors shall comply with the regulations of the Federal Motor Vehicle Carrier Safety Administration (FMCSA) [USA] or Transport Canada [CAN].

## **6.6 WHEEL & TIRE REQUIREMENTS**

### **6.6.1 MAINTENANCE REQUIREMENTS**

Removal, inspection, and installation of wheels should always be performed following the vehicle manufacturer recommendations.

- Wheels and tires on all vehicles and equipment shall be inspected by an approved service provider or as part of the preventive maintenance schedules designated for the vehicle or equipment types.
- A certified torque wrench must be used when mounting all tires on vehicles and trailers, using specs determined by the vehicle or trailer OEM-and documented records to be provided and retained as per company retention requirements.
- Employees must be trained and qualified to utilize a torque wrench on Enbridge Fleet Vehicles

- Universal joints should not be utilized when torquing or retorquing.
- The use of torque sticks when fastening wheel nuts is prohibited.
- All parts must be inspected by a competent person.
- Wheel studs and nuts should be replaced if identified as over torqued or if there is visible damage.
- Chemical compounds must not be used at the sealing face of the rim and hub, and they should be cleaned and free of any debris prior to installation.
- Refer to manufacturer's specifications for specific equipment requirements.

### **6.6.2 PURCHASING REQUIREMENTS**

- Only tires date stamped less than one (1) year old should be installed – specific to new tire purchase and installation (tires have 4-digit code, first two numbers is week made, last two numbers indicate year).
- Tires that exceed six years past the manufacturer date (tires have 4-digit code, first two numbers is week made, last two numbers indicate year) should be thoroughly inspected for irregular wear by qualified technician for damage; this may include damage from long term storage outdoors.
- Tires should be replaced as recommended by the vehicle or equipment manufacturer or based on the condition of the tire if the manufacturer does not make recommendations.
- On all vehicles other than dual wheeled vehicles, all four (4) tires are to be of the same specifications (rating, size, configuration).
- Dual wheeled vehicles and trailers should have the same tire specifications.
- Only purchase manufacturer approved wheel studs.

### **6.6.3 CHANGING A TIRE**

Practices and procedures will incorporate the below recognized tasks that include but are not limited to:

- Set brake and chock wheels;
- Shut off engine and secure keys
- Removal and installation of wheel nuts include:

- Wheel torquing to follow manufacturer's specifications – this includes potential breakaway torque and re-torquing procedures if and where applicable (in the event of a flat tire, replace with a properly torqued permanent replacement as soon as possible);
  - Re-torque after 60 miles (100 km);
  - For vehicles equipped with dual rear wheels, complete an additional re-torque after 500 miles (800 km)
  - Initial finger installation – hand tighten, do not use impact wrench;
  - Tightening pattern and torquing as per manufacturer's requirements;
- Follow safe jacking and hoisting procedures as per manufacturer's requirements;
  - Preparation and visual inspection of mating surfaces (wire brushing studs and surface to remove rust and debris). In the event of a flat tire, follow manufacturer's recommendations.

Refer the specific vehicle or trailer owner's manual for specific requirements when removing or installing wheels.

#### 6.6.4 WHEEL NUT INDICATORS

Wheel nut indicators are an industry best practice that provides drivers with a tool to easily identify the potential loosening of a wheel nut. They are visual indicators of the status/tightness of wheel nuts. As of January 1, 2024, wheel nut indicators will become mandatory on company-owned/leased fleet vehicles and trailers that meet the following criteria:

- Vehicles 10,001 lbs./4536 kg GVWR and above
- Trailers 6172 lbs./2800 kg GVWR and above
- Trailers with dual wheels of any GVWR

Wheel nut indicators shall be installed on vehicles and trailers where OEM configuration allow. In some instances, OEM design may not allow wheel nut indicators to be installed (e.g., locking lug nuts, aluminum wheels with hub caps). In these instances, Vehicle Operators/Drivers shall rely solely on their due diligence to ensure lug nuts are secure.

### 6.7 TELEMATICS

#### 6.7.1 PURPOSE OF TELEMATICS

Telematics is a system or technology used to collect vehicle information through satellites, cellular towers, or other data collection systems.

Telematics identifies 'at risk' driving behaviors such as speeding, seat belt usage, harsh braking/acceleration/cornering and provides real-time feedback to the driver for the purpose of

reducing these high-risk behaviors. Telematics is also an integrated in-vehicle telecommunications / GPS device that collects information on vehicle operation and engine performance.

Telematics is an important resource for the following reasons:

- Employee safety whereby the driver receives immediate feedback concerning his/her driving behaviors and provides an opportunity to improve driving behaviors. Also, location data, coupled with other relevant information or systems, allows for assistance to be rendered to employees;
- Identification of closest or best responders for public safety, emergency response as well as service to customers;
- Reduce fleet costs by monitoring of fuel consumption, idle time, miles/kilometers driven, and engine starts and stops;
- Environmental stewardship including monitoring and reducing idling time, thereby reducing CO<sub>2</sub> emissions;
- Productivity whereby work locations are accurately identified, travel time is reduced, customer service is improved, work is effectively routed; and
- Analysis of events and/or complaints, including internal, public or customer complaints.

Telematics records relevant data including speed, acceleration, braking, collision information, air bag deployment, engine performance, location, mileage, trip route, vehicle ignition, start and stop times, seatbelt usage and duration of engine idling. As technology is developed, additional vehicle data may be collected in the future.

Telematics complements other Enbridge safety programs and systems.

Enbridge will ensure that this standard will be implemented in compliance with all applicable federal, provincial and states laws and regulations.

---

### 6.7.2 COLLECTION, STORAGE AND ACCESS TO TELEMATICS DATA

Telematics data will be limited to specific management personnel and other staff who need to access Telematics data to fulfill their responsibilities and will be trained on the appropriate usage of such data.

Access will be limited to the following positions:

- Fleet Safety Specialist (Admin)
  
- Managers (Read Only)
  
- Directors (Read Only)
  
- Direct People Leader (Read Only)
  
- Region Admin (Admin)
  
- Local Support (HOS)

**Note:** Additional access will be granted based upon business need with approval from BU Director and Fleet Safety Specialist

Telematics location data about vehicles is not disclosed outside of Enbridge, except if required by law.

Telematics data is normally retained for thirty-six (36) months except where a special need requires longer retention, such as in cases of vehicle events.

### 6.7.3 REPORTING

All Regions will be provided the following reports on a monthly basis:

- Monthly Mileage
  
- Driver Scorecard (will capture the following items)
  - Speeding
  - Harsh braking
  - Harsh acceleration
  - Harsh cornering
  - Seat belt usage

---

#### **6.7.4 PRIVACY**

Telematics information related to safe driving practices and adherence to company policies will be accessed and monitored on a regular basis by management.

Location data is not accessed for day-to-day performance management. Live location data may be used to locate drivers who are working alone and cannot be contacted through traditional means (phone, radio, etc.). Telematics data may be aggregated or used individually for business purposes, including as an event analysis tool, review of complaints, for work planning or work performance concerns.

Affected employees will be provided all relevant communications concerning the use of Telematics, including any notices required by law or regulation.

Individuals that are provided access to database will be required to receive privacy training prior to gaining access.

People Leaders must notify Safety when employees leave the company to terminate access to telematics database.

#### **7.0 TRAINING**

Personnel working in the field must be knowledgeable in this Standard and may be assigned applicable training as driven by the Safety Training Matrix.

Reference the Health & Safety training syllabi and matrices for further information and training re-certification requirements.

#### **8.0 RELATED DOCUMENTS**

Commercial Motor Vehicle Standard – Canada

Commercial Motor Vehicle Standard - US

Driver's License & Driving Record Policy

Environmental Conditions Standard

Fatigue Management Standard

Motor Vehicle Records Standard

Safety While Driving Policy

Vehicle Rental Policy

Workplace Drug & Alcohol Policy

#### **9.0 STANDARD REVIEW**

A subject matter expert (SME) will perform a technical review of this standard every two years to determine the accuracy of the content/information. The SME shall solicit input from applicable





**CHANGE LOG**

Section	Version 2.1	Version 2.2
6.6.3	<ul style="list-style-type: none"> <li>▪ Re-torque after 60 miles (100 km);</li> </ul>	<ul style="list-style-type: none"> <li>▪ Re-torque after 60 miles (100 km);</li> <li>▪ For vehicles equipped with dual rear wheels, complete an additional re-torque after 500 miles (800 km)</li> </ul>
5.0, 4.7.1, 6.7.1, 6.7.2, 6.7.4		Updated terminology from incident and investigation to event and analysis to align with Management System Framework - Event Analysis.
All sections		Clerical corrections including spelling, grammar, and document names.

<End of Document>



---

# Standard

---

## Walking-Working Surfaces and General Housekeeping

---

**Effective Date:** 2019-03-30

**Version #:** 1.4

**Version Date:** 2024-03-27

---



This page intentionally left blank



**Document Version Register**

<b>Version Number</b>	<b>Version Date</b>	<b>Approved By</b>	<b>Section Number and Title</b>	<b>Details of Version</b>
1.0	2019-03-30	Sean Evans	Whole Document (New Standard)	This is the new H&S standard that was developed as part of the LP   MP Safety Manual Transition Project
1.1	2019-10-31	Sean Evans	5.0	See change log
1.2	2020-06-01	Sean Evans	2.0	Alignment with contractor safety specifications
1.3	2021-12-01	Murray Evenson	9.0	Updated section 9 to reflect the appropriate review process
1.4	2024-03-27	Troy Croft	All sections	Clerical corrections

**Uncontrolled if Printed or Downloaded**

**Internal Information**



This page intentionally left blank

---

## Table of Contents

1.0	Purpose .....	2
2.0	Scope .....	2
3.0	Prerequisites.....	2
4.0	Definitions & Acronyms .....	2
5.0	Roles & Responsibilities.....	3
6.0	Standard-Specific Requirements .....	3
6.1	General Housekeeping.....	3
6.2	Walkways, Stairways, Exits, Platforms, Landings and Openings .....	5
6.3	Scaffolds.....	5
6.4	Non-Mobile Elevated Work Platforms .....	9
6.5	Storage and Laydown Yards .....	9
6.5.1	Pipe Handling and Storage.....	10
6.6	Inspections.....	12
7.0	Training Requirements .....	12
8.0	Related Documents.....	13
9.0	Standard Review .....	13
10.0	References .....	13
	Change Log.....	14

---

## 1.0 PURPOSE

The purpose of this standard is to protect employees against dropped objects and/or slip, trip and fall hazards while they are working on or near elevated walking or working surfaces.

## 2.0 SCOPE

This standard applies to LP Operations and Projects being completed for LP.

Contractors and subcontractors shall comply with Enbridge health and safety requirements set out in this standard, as articulated within applicable contractor safety specifications. If a contractor or subcontractor has a health and safety standard or policy materially different from Enbridge's, the contractor/subcontractor shall follow the most stringent requirement. Contractors and subcontractors are still obligated to meet the requirements of all applicable laws related to this standard.

In the event a contractor's or subcontractor's standard exceeds the requirements of this standard, Enbridge may, in its sole discretion, choose to adopt the contractor's or subcontractor's standard for any given contract or work order.

## 2.1 PREREQUISITES

Fall Protection Standard

Flagging & Warning Signs Standard

Hazard Assessment, Elimination and Control Standard

Inspection Standard

Safe Work Permit & Work Authorization Standard

## 3.0 DEFINITIONS & ACRONYMS

*Barricade*—an obstruction to deter the passage of persons or vehicles.

*PPE* – Personal Protective Equipment

*Qualified*—one who, by possession of a recognized degree, certificate, or professional standing, or who by knowledge, training and experience, has successfully demonstrated his ability to solve or resolve problems relating to the subject matter, the work, or the project.

*ROW* – Right-of-way

*Sills*—means a wood, concrete or metal footing used to distribute the load from a standard, an upright or a base plate of a scaffold to the ground.

*TDG* – Transportation of Dangerous Goods

*Walking-working surface*—means any horizontal or vertical surface on or through which an employee walks, works, or gains access to a work area or workplace location.

---

## **4.0 ROLES & RESPONSIBILITIES**

People Leaders shall:

- Ensure provision of sufficient resources to effectively implement this standard;
- Ensure applicable inspections are completed and corrective actions are implemented on a timely basis; and
- Ensure all workers are qualified to perform their assigned tasks and roles.

Workers shall:

- Immediately address deficiencies related to walking-working surfaces and general housekeeping requirements as detailed within this standard;
- Notify their people leader immediately of found deficiencies that cannot be addressed by the employee; and
- Perform inspections as required.

Safety Team shall:

- Provide timely advice, support and assistance to People Leaders and employees in the implementation of this Standard; and
- Perform inspections when designated.

Safety shared services shall:

- Be responsible for the maintenance and continuous improvement of this standard.

## **5.0 STANDARD-SPECIFIC REQUIREMENTS**

All places of employment, passageways, storerooms, service rooms, and walking-working surfaces are kept in a clean, orderly, and sanitary condition.

The floor of each workroom is maintained in a clean and, to the extent feasible, dry condition. Walking-working surfaces are maintained free of hazards such as sharp or protruding objects, loose boards, corrosion, leaks, spills, snow, and ice.

Walking-working surfaces are inspected, regularly and as necessary, and maintained in a safe condition. Hazardous conditions on walking-working surfaces are corrected or repaired before an employee uses the walking-working surface again. If the correction or repair cannot be made immediately, the hazard must be guarded to prevent employees from using the walking-working surface until the hazard is corrected or repaired.

### **5.1 GENERAL HOUSEKEEPING**



Good housekeeping practices shall be maintained at all Enbridge locations including, administrative and field offices, staging areas, on or off-site storage areas, facility construction sites and right-of-way's (ROWs).

Suitable safeguards, flagging or barricades with warning signs or flashing lights shall be used to protect workers from any work activity that may endanger them. Examples of such activities include sand blasting, open excavations, temporary openings in floors, construction, arc flash in pre-fab areas, pressure testing or overhead work.

Barricades shall be inspected periodically to ensure protection for workers is adequate, and that they are still present and in good condition.

The use of industrial style dumpsters is recommended in areas where large volumes of waste can be expected. Garbage shall not be allowed to accumulate on a construction ROW. Ensure waste receptacles are emptied regularly and all garbage is collected and removed as required. Wildlife risks need to be assessed when determining waste receptacle and removal criteria.

To maintain a clean, hazard-free workplace, all groups shall follow the general practices for safe housekeeping which include but are not limited to:

- Ongoing worksite cleanup,
- Individual cleanup duties for all workers,
- Materials piled, stacked, or otherwise stored to prevent tipping or collapsing,
- Materials stored away from overhead powerlines, and
- Work, travel and emergency equipment areas kept tidy, well-lit, and ventilated.

Rebar, T-bar and other impalement hazards shall be capped or otherwise protected.

When wheel chocks or blocks are used to prevent equipment from rolling and prevent heavy parts and equipment from falling, check with fellow workers before removing chocks or blocks.

Overhead ice buildup should be removed as soon as it starts to occur, to prevent the formation of a large mass that could potentially injure workers or damage equipment. The removal method shall be determined based on the hazards present.

Workers shall take all appropriate measures to prevent slipping hazards in all work areas and walkways. Such measures or controls may include the application of sand or other approved materials that provide grip and traction.

In addition, all work areas and walkways shall be visually identifiable through signage, flagging, or other methods appropriate for the work and weather conditions.

At all times, work areas and walkways shall be maintained to minimize the risk of slips or falls, including:

- Covering of holes and openings,

- Good housekeeping,
- Removal or repair of uneven walking surfaces, e.g., repair of uneven floor boards, and
- Removal of unnecessary objects or equipment.

Work areas and walkways shall be kept clear of snow and ice. As appropriate, use authorized traction control aids, such as sand, gravel or an approved snow melt.

When weather conditions (such as snow, fog or rain) may contribute to or increase Hazards (e.g., by obscuring a hazard), workers shall identify the hazardous areas, e.g., with flagging, marking or other appropriate means.

Where use of a traction control aid is not authorized or appropriate, workers, in consultation with their people leader, shall identify alternative means of reducing, eliminating or controlling the hazard, such as traction aids or grated walking surfaces.

Be aware of the potential for different hazards related to ice and/or snow. For instance, ice build-up or slippery conditions may be present under snow cover. Other hazards may also be present or hidden under ice or snow.

## **5.2 WALKWAYS, STAIRWAYS, EXITS, PLATFORMS, LANDINGS AND OPENINGS**

Walkways shall be designated and kept clear of hazards, debris, snow and ice.

Stairways, landings and exits shall:

- Be equipped with a handrail if it has more than 4 risers or rises more than 0.75 meters (30 inches); or
- Comply with applicable legislation including building codes, whichever is more stringent.

All permanent floor, walkway, working platforms, vault, handrail and ground openings that present a fall hazard of over 1.3 m (4 ft.) shall be properly guarded and marked utilizing either a guard rail, safety net or personal fall protection system.

Exposed duct banks and conduit shall not be used as walkways.

Workers shall not walk or stand on exposed pipes.

Attention must be provided to outside work areas with uneven ground or matting. Tripping hazards must be addressed immediately as appropriate.

Building exits shall be marked and shall have emergency lighting where required by applicable legislation.

## **5.3 SCAFFOLDS**

Workers using scaffolds, swing stage scaffolds and non-mobile elevated work platforms shall use personal fall protection systems when working at heights greater than 1.2 m (4 ft.) without proper guardrails.

Workers shall not:

- Sit or climb on the edge of the swing stage, work cage or scaffold handrails;
- Use ladders, unsecured planks or other devices as a work platform; and
- Work on scaffolds covered with snow, ice or other slippery material except as necessary to remove such materials.

Workers shall:

- Check the scaffold inspection tag prior to use to ensure the scaffold is fit for the intended use; and
- Lift or lower larger articles from elevated locations by a hand line or a hoist.

Scaffolds shall:

- Be installed, inspected, maintained, and repaired in accordance with the manufacturer's specifications and applicable legislation;
- Be erected and dismantled under the supervision of a qualified worker, competent in their construction and use;
- Be erected plumb to ensure maximum structural capacity of the system;
- Have a maximum height of three times the minimum base width unless additional stabilizing supports are used;
- Have a qualified worker confirm that the scaffold is erected properly and attach an inspection tag (which includes the load rating) prior to allowing work to commence, and
- Use components and planking that are in good repair.

If the scaffold is higher than 15 m (50 ft.), it shall be designed by a professional engineer, and erected, used and maintained in accordance with the engineered design.

Workers who are involved in erecting, disassembling, moving, operating, repairing, maintaining, or inspecting a scaffold shall be trained to recognize any hazards associated with the work.

All workers who perform work while on a scaffold shall be trained by a qualified worker to recognize the hazards associated with the type of scaffold being used and to understand the procedures to control or minimize those hazards.

When erecting and dismantling supported scaffolds, a qualified worker shall ensure that all fall protection requirements are met and that a safe means of access is provided.

Scaffold components shall meet all applicable legislation as well as the following requirements set out in this manual:

- Scaffold bases shall:
  - Be set on level and compacted soils or other solid surface (i.e. concrete);

**Uncontrolled if Printed or Downloaded**

- Have base plates (preferably with screw jacks to allow for adjustment) and should rest centrally on sills as required by ground conditions;
- Be capable of carrying, without dangerous settling, all loads that are likely to be imposed on them;
- Have sills that are not constructed by joining smaller pieces of wood together;
- Not have a smaller dimension than 1/3 of the height of the scaffold without outriggers;
- Have outriggers on base plates, fastened at approximately 1/3 of the total height when required; and
- Have bridging that is secured in place, when bridging is required.
- Scaffold supports and bracing shall:
  - Be securely fastened in accordance with manufacturer's specifications;
  - Have all structural members in place;
  - Have all cross braces in place;
  - Be tied or secured to a building or other structural supports if the height exceeds 3 times the smallest base dimension;
  - Increase the number of ties if hoarding/enclosure is used in windy conditions or if there are other dynamic loads caused by the work being done on the scaffold; and
  - Have ties that are placed as the scaffold is being erected.
- Scaffold planking shall:
  - Be manufactured scaffold planks that are used, stored, inspected and maintained according to manufacturer's specifications; or solid sawn lumber planks that are rated as scaffold grade or better;
  - Be visually inspected before installation;
  - Be replaced if it does not pass visual inspection;
  - Extend over the centerline of its support at least 6 inches (15 cm), unless cleated or otherwise restrained by hooks or equivalent means or as directed by manufacturer's specifications; and
  - Be secured to prevent movement in any direction.
- Scaffold platforms shall:
  - Be identified as light or heavy duty; and
  - Be fully planked between the front uprights and the guardrail system.

**Uncontrolled if Printed or Downloaded**

- Scaffold guardrails shall:
  - Be installed on all platforms above 1.2 m (4 ft.).
- Scaffold toe boards shall:
  - Be used on the outer edges and the ends if the height of the scaffold planking is greater than 2 m (6 ft.).
- Scaffold ladders shall:
  - Be installed as the scaffold is being built;
  - Shall extend 1 m (3 ft.) above the top of the scaffold platform and shall be secured at the top when using portable ladders; and
  - Portable ladders shall be secured at the bottom or tied to the scaffold at waist height and flagged.

Internal stairways or built-in ladders are required for scaffolds greater than 9.1 m (30 ft.) high.

Attachable vertical scaffold ladders exceeding 6.1 m (20 ft.) in height shall be equipped with one of the following:

- A safety cage that complies with applicable legislation;
- Proper fall protection; and
- Rest platforms.

Workers shall not climb braces or end frames.

Using equipment to hoist workers to a work area is prohibited unless it is demonstrated that conventional means would be more hazardous, or that conventional means would not be possible because of the project's structural design or worksite conditions. (In this case "conventional means" refers to the erection, dismantling and/or use of means such as ladders, stairways, scaffolds, personnel hoists, aerial lifts or elevating work platforms.)

Swing stages or suspended scaffolds, work cage platforms and man baskets shall:

- Not exceed the manufacturer's rated working load;
- Have the manufacturer's platform load rating clearly labeled and visible to all workers;
- Be installed by a qualified worker;
- Have the rated capacity of rigging hardware (e.g., hooks, shackles, rings, bolts, slings, chains, wire ropes, splices) capable of supporting at least 10 times the maximum load to which it may be subjected; and
- Use wire rope suspension lines that are free of kinks, birdcaging, excessive wear, broken wires, flat spots and other defects.

Swing stage or suspended scaffolds, work cage platforms and man baskets shall be designed and certified by a professional engineer when used for hoisting workers. A copy of the certification, equipment drawings, and the most recent inspection certificate shall be available upon Enbridge's request.

Swing stages require a redundant system for control (such as a deadman switch/pedal or tandem operation) and properly sized and secured hangers or stirrups.

For work cages, when it is not practicable to provide a separate personal fall arrest system using a vertical lifeline for each worker in the work cage, then there shall be a separate support attached between the work cage and the hoist line. The support shall be above the hook that is capable of holding the weight of the work cage and any potential contents.

#### **5.4 NON-MOBILE ELEVATED WORK PLATFORMS**

All non-mobile elevated work platforms shall be equipped with:

- Handrails;
- Midrails;
- Toeboards;
- Skid-resistant working surfaces; and
- Wire mesh from the top rail to the toeboard if required by the hazard assessment.

When swing stages and work cages are being used, emergency rescue procedures shall be documented in the fall protection plan or critical lift plan and communicated to all workers.

Unprotected temporary openings in floors or elevated work platforms shall:

- Be covered with plywood that is at least  $\frac{3}{4}$  of an inch in thickness;
- Have secured coverings capable of supporting twice the maximum intended load;
- Only be removed to perform a particular task; and
- Be color coded or effectively marked with the word 'HOLE' or 'COVER' to effectively warn workers of the hazard.

Coverings shall be replaced immediately after the task is complete or as appropriate during the task if other workers are present near the work area.

#### **5.5 STORAGE AND LAYDOWN YARDS**

Warehouse, laydown and storage areas shall be designated as work areas where PPE is required.

Ensure all materials are stored in designated areas. Ensure layout and access is convenient for unloading and loading trucks and that there is sufficient clearance for safe movement of all necessary vehicles.

Storage requirements include:

- Metal containers with lids shall be kept at convenient locations, to facilitate effective waste disposal;
- Overhead clearance shall be posted wherever necessary;
- Overhead power lines shall be clearly identified;
- Lumber shall be stored free of protruding objects;
- With the exception of large tanks, all materials must be stored off of the ground on racks, skids, planks or other safe and appropriate materials;
- Stored material shall be stacked securely, to ensure prevention of tipping, sliding, collapse or other hazards;
- Pipe shall be adequately blocked/chocked when stored.
- Shelving shall:
  - Be marked with weight limits;
  - Be secured;
  - Have determined inspection timeline requirements.
- All secured loads shall be assessed prior to the release of the securing mechanism; and
- Carefully assess the load to ensure the load has not shifted during transport.

All dangerous goods being transported shall meet regulatory requirements for TDG documentation and labelling.

### **5.5.1 PIPE HANDLING AND STORAGE**

Workers shall be trained in hazard identification and control when working with pipe and materials.

Follow these requirements:

- Ensure the appropriate lifting equipment is used, i.e., side booms, track-hoes equipped with vacuum devices and cranes;
- Ensure pipe and fittings are handled using only approved rigging equipment designed not to damage the load, i.e., Teflon or brass insert stringing pipe hooks (sorting hooks) and nylon slings;
- Whenever possible, place pipe or materials in a flat area or parallel with a slope, rather than across a slope;
- Secure pipe or materials from movement by blocking, cradling, or a combination of both, or use an approved alternative method (see Figure 1);

**Uncontrolled if Printed or Downloaded**

- 
- Ensure pipe blocks have sufficient strength to hold the weight of the load;
  - Secure pipe blocks to prevent loads from being removed or dislodged. Skids are considered to be secured if the weight of the pipe or barrel prevents the skid from being dislodged or removed (see Figure 1);
  - Ensure cross timbers are placed approximately 1 m (3 ft.) from the ends of the pipe;
  - Stand clear when cutting steel bands or wire that secures a load of pipe to a vehicle or rail car;
  - Keep hands clear of pipe-ends when pipe is being butted together; and
  - Use tag lines.

Ensure pipe that is being stored (e.g., in populated areas or at road crossings) is equipped with end caps or secured to prevent unauthorized entry.



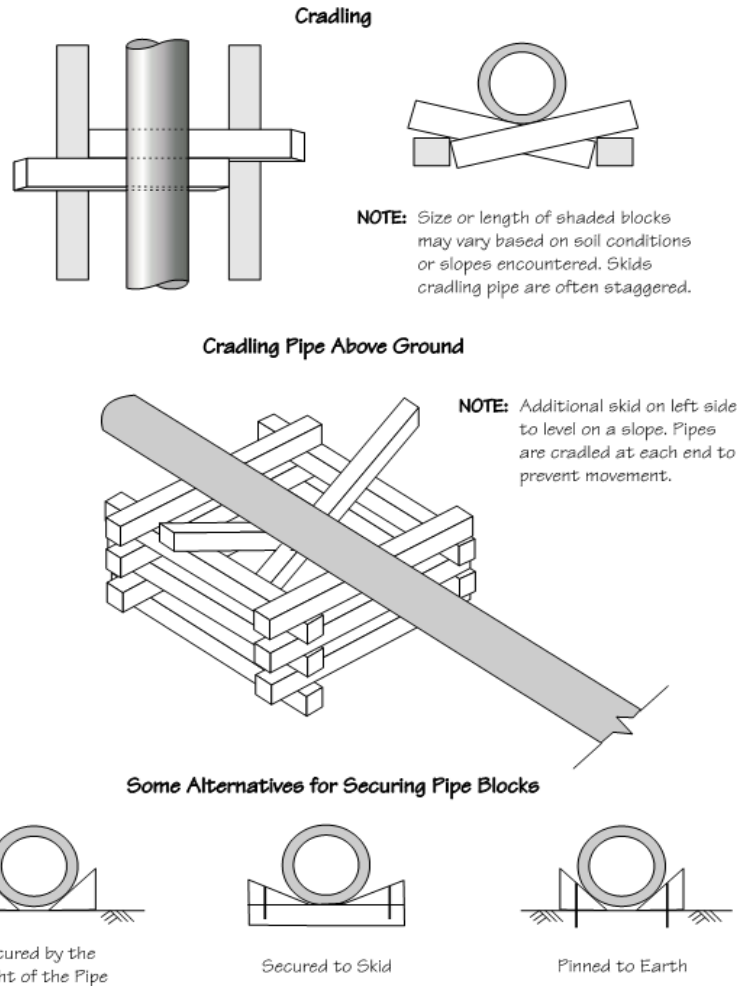

Figure 1

## 5.6 INSPECTIONS

Inspections will be completed as determined by the requirements of the Inspection Standard.

## 6.0 TRAINING REQUIREMENTS

Personnel working in the field must be knowledgeable in this Standard and may be assigned applicable training as driven by the Safety Training Matrix.

Reference the Health & Safety training syllabi and matrices for further information and training re-certification requirements.

---

## **7.0 RELATED DOCUMENTS**

Not applicable

## **8.0 STANDARD REVIEW**

A subject matter expert (SME) will perform a technical review of this standard every two years to determine the accuracy of the content/information. The SME shall solicit input from applicable stakeholders to ensure the effectiveness of the standard. Any suggested changes must be reviewed and approved by the designated document owner.

## **9.0 REFERENCES**

Occupational Safety and Health Administration (OSHA)

- Walking-Working Surfaces, Fall protection systems and falling object protection, 29 CFR 1910.29
- Scaffolds, 29 CFR 1926.451

Canada Labour Code Part II, Canadian Occupational Health & Safety Regulations,

- PART II Permanent Structures, 2.1 Division I Buildings
- Part III Temporary Structures & Excavations



---

## CHANGE LOG

Section	Version 1.3	Version 1.4
Entire Document		Clerical corrections including spelling, grammar, and document names

<End of Document>