



LP Contractor Safety Specifications

Effective Date: 2019-03-30

Version #: 2.2

Version Date: 2023-10-06

SME Owner: Andy Reimer

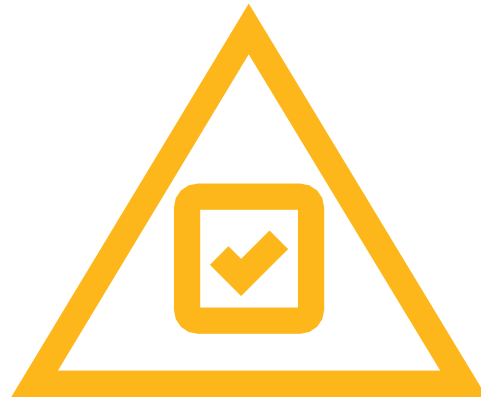

Rule 1
Hazard Management

I will complete a hazard assessment prior to starting work and reassess if conditions change and new hazards are introduced



Rule 2
Driving Safety

I will only operate a motor vehicle or mobile equipment when free from the adverse effects of alcohol or any substance that causes impairment



Rule 3
Confined Space Entry

I will confirm the atmosphere has been tested, is monitored and a plan is in place prior to entering a confined space

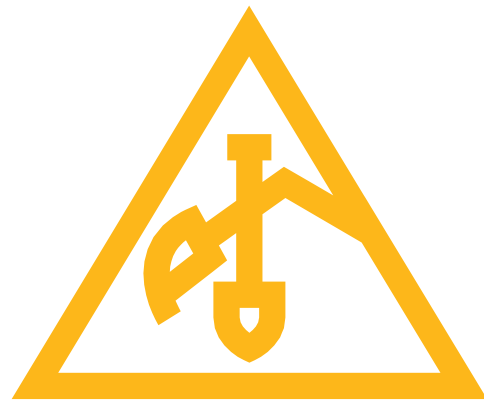

Rule 4
Ground Disturbance

I will verify the location of buried utilities through surface locating and positive identification prior to conducting a mechanical excavation



Rule 5
Isolation of Energized Systems

I will verify isolation and zero energy before work begins on energized or pressurized systems (Lockout/Tag-Out)

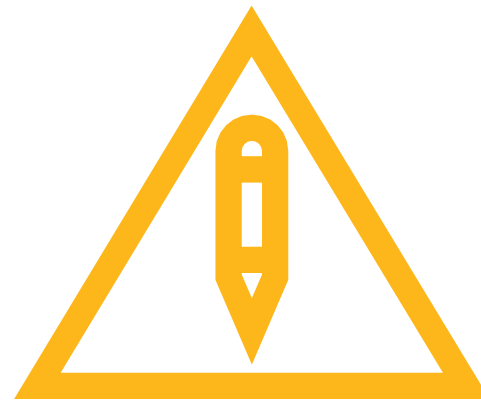

Rule 6
Reporting Safety Incidents

I will immediately report significant safety-related incidents



Rule 7
Bypassing Safety Controls

I will obtain authorization before overriding or disabling safety-critical equipment or controls

Lifesaving Rules

Working for Enbridge means working safely. At Enbridge, we value the safety of our communities, customers, contractors and employees. Together, we must strive to make sure work-related injuries and fatalities are a thing of the past. The Lifesaving Rules are seven simple and powerful rules based on real incidents at Enbridge and developed in consultation with some of the top safety experts in the world. These rules focus our attention on the high-risk, high-consequence hazards of our work and the key actions we must take to protect ourselves and our colleagues from harm. The Lifesaving Rules help us to deliver on our shared commitment that every member of the team goes home safe at the end of every day.

For more information, visit **Elink** and search **Lifesaving Rules**.





Our Path to Zero

SAFETY PRINCIPLES AT ENBRIDGE OUR COMMITMENT

Enbridge is committed to ensuring everyone returns home safely at the end of each and every day, and that our assets are operated in a safe and reliable manner. **We base our commitment to safety on our care for employees, contractors, the communities in which we operate and the environment.**

Our values of Integrity, Safety and Respect guide our decisions, actions and interactions individually and as a company. Our Safety Principles support our values and highlight the fundamental beliefs we share on our path to a zero-incident workplace.

Safety. It's a core value that makes us Enbridge. It's our way of life.

SAFETY PRINCIPLES OUR PATH TO ZERO

1. All injuries, incidents, and occupational illnesses can be prevented.

Enbridge is committed to protecting the health and safety of our employees, our contractors and the public. Our goal is zero injuries, incidents and occupational illnesses. Striving for anything less can lead to the false belief that injuries, incidents and occupational illnesses are inevitable and acceptable. In every instance, protecting the health and safety of workers and the public requires strict adherence to company policies and procedures, including Enbridge's Lifesaving Rules.

2. All operating exposures can be controlled.

Enbridge believes that all operating exposures and uncontrolled releases that may result in injury, illness or environmental damage can be prevented. Through the rigorous application of process safety requirements we strive to eliminate hazards and minimize risks by implementing effective safeguards. When it is not possible or practical to completely eliminate hazards, we implement engineering controls such as fail-safe control systems, warning and detection devices, and automatic safety devices to reduce the risk. Administrative controls and/or personal protective equipment serve as the last line of defense against the hazards we face.

3. Leaders are accountable for safety performance.

People leaders are accountable for safe operations and the safety and health of the workers under their care. This includes accountability for establishing and maintaining a safe work environment through the application of our Management System. As well, it includes establishing, regularly reviewing and updating policies and procedures using disciplined change management, providing the proper equipment, completing appropriate training, correcting deficiencies promptly, and ensuring approved procedures are followed.

4. All employees/contractors are responsible for safety.

People are the most important element of our health and safety program and ensuring our operational reliability. Enbridge expects employees and contractors to take personal accountability for their safety, that of their co-workers and the general public, and the safe operations of our assets. Further, workers have not only a right but a duty to stop and/or refuse work they feel is unsafe. Our success depends on all levels and all members of the organization being committed and accountable for consistently adhering to our company policies and procedures as well as all applicable regulations, codes and standards. Working safely is a condition of employment.

5. Assessment and improvement are a must.

Enbridge is committed to continuously improving our safety performance through field and operational assessments, and diligent application of quality and safety assurance practices and processes. Further, we employ disciplined root cause analysis and thoughtful exploration of human factors during incident investigations to identify and learn from weaknesses in our safety systems. We promptly address deficiencies revealed through these activities, and communicate what we learn across the organization to strengthen our systems and make Enbridge even safer.

6. We promote off-the-job health and safety for our employees 24/7.

Our concern for the safety and health of employees extends beyond the workplace. An off-the-job injury is as painful and impactful as one suffered on the job. We encourage our employees to demonstrate their leadership and excellence in health and safety practices for the benefit of their families, friends and community. An engaged workforce is a key building block of a healthy safety culture.

We strive to create a vigilant and resilient safety culture, in which all members of our team keep themselves and others safe, leaders care for the health and safety of their people, and we learn from safety failures to prevent future incidents. Our Safety Principles are foundational to our safety culture and our long-term success as an organization.



Contractor Safety Specification

Atmospheric Monitoring

Table of Contents

1.0	Definitions & Acronyms	2
2.0	Contractor Responsibilities	3
3.0	Specification Requirements	3
3.1	Portable Atmospheric Monitoring and Sampling – General Requirements	3
3.1.1	Personal and Area Gas Monitor Device Requirements	5
3.2	Sampling Equipment	7
3.3	Initial Atmospheric Monitoring	7
3.4	Bump Testing, Calibration, and Maintenance of Equipment	8
4.0	Training	9
5.0	References	10

1.0 DEFINITIONS & ACRONYMS

Active monitors – A personal gas monitor that has internal pumps that draw atmospheric samples from the immediate area or from a distance (e.g., inside a pipe, sump, booster pit).

Air-purifying respirator - A respirator with an air-purifying filter, cartridge, or canister that removes specific air contaminants by passing ambient air through the air-purifying element. (Source OSHA 1910.134)

Area monitor - A gas monitor that is positioned in the work environment in a fixed location in a work area.

Breathing zone - a hemisphere forward of the shoulders within a radius of approximately 15 to 23 centimeters (6 - 9 inches). (OSHA Technical Manual)

Bump test – A qualitative function check where a challenge gas is passed over the sensor(s) at a concentration and exposure time sufficient to activate all alarm indicators to present at least their lower alarm setting. The purpose of this check is to confirm that gas can get to the sensor(s) and that all the alarms present are functional.

Calibration - The adjustment of the sensor(s) response to match the desired value compared to a known traceable concentration of test gas. This should be done in accordance with the manufacturer's instructions.

Enbridge- Enbridge, Inc. and Enbridge (U.S.) Inc., hereinafter will be referred to as "Company".

Hazardous atmosphere - an atmosphere that may expose workers to the risk of death, incapacitation, impairment of ability to self-rescue (that is, escape unaided from a permit space), injury, or acute illness from one or more of the following causes (1) Flammable gas, vapor, or mist in excess of 10 percent of its lower explosive limit (LEL),

Immediately dangerous to life or health (IDLH) - an atmosphere that poses an immediate threat to life, would cause irreversible adverse health effects, or would impair an individual's ability to escape from a dangerous atmosphere. (Source OSHA 1910.134)

Lower Explosive Limit (LEL) - That concentration of a flammable vapor in air below which ignition will not occur.

Passive monitors – a personal gas monitor that assesses the atmosphere without the use of a pump.

Personal gas monitor - A device worn by a person to provide warning when alarm levels of a hazardous atmosphere are reached. A personal gas monitor helps to ensure worker safety by identifying potential hazardous atmospheres.

ppm - Parts per million

Respiratory Protection Equipment (RPE) - A protective device that covers the nose and mouth or the entire face or head to guard the wearer against hazardous atmospheres.

Sampling equipment – Equipment that is used to acquire a sample in the field utilizing several collection devices such as filters, absorbents, adsorbents, impingers. The collected sample is then sent to a laboratory for analysis.

SWP – Safe Work Permit

2.0 CONTRACTOR RESPONSIBILITIES

Contractor shall:

- Ensure that workers under their control are aware of and comply with this Specification;
- Ensure that all required atmospheric monitoring resources are readily available and functioning properly for Contractor workers and all other persons that enter a work site as required by this Specification, industry standards, and applicable law
- Ensure that Contractor personnel and all other persons present at a work site are properly trained before using atmospheric monitoring and/or sampling equipment.
- Inspect, calibrate, bump test and operate all atmospheric monitoring equipment as per manufacturer's specifications;
- Ensure all training requirements are up to date; and
- Follow site emergency response procedures as appropriate upon atmospheric monitoring equipment alarm.

3.0 SPECIFICATION REQUIREMENTS

3.1 PORTABLE ATMOSPHERIC MONITORING AND SAMPLING – GENERAL REQUIREMENTS

Monitoring and sampling shall be completed on a frequency as determined by the project safety plan, the site specific plot plan, and/or a hazard risk assessment. The risk assessment should take into account the presence and potential for a hazardous atmosphere and the degree for which a hazardous atmosphere could generate in the work area during work activities. Areas with significant risk (a "higher" likelihood of a hazardous atmosphere developing) would require a higher frequency of monitoring to the extent that each worker would require an individual gas monitor and area monitoring/sampling as needed.

Unless the results of the risk assessment or hazard assessment determine that there is not a presence or a potential for an atmospheric atmosphere, Personal gas monitors shall be used in fenced operating facilities (with the exception of administrative buildings and parking lots), hazardous or restricted areas, or within 30 m of a ground disturbance.

Due to the higher likelihood and the severity of a hazard, the following areas or work activities shall require a written monitoring plan (this can be included on the Field Level Hazard Assessment) that shall include either area or personal monitors where use and frequency is determined per a hazard assessment.

- Working in confined spaces where there is the potential for a hazardous atmosphere,
- Removing storage tank seals, tank manways or tank mixers,
- Entering tanks that have not been cleaned and freed of gas,
- Work associated with Open Systems, such as scraper traps and provers,
- Spill or leak containment, clean-up and repairs,
- As required and noted on the Safe Work Permit (SWP),
- When required based by a Hazard Assessment, and
- Where the potential for an IDLH atmosphere exists.

Personal Monitors shall:

- Be used according to manufacturer specifications,
- Be worn in the breathing zone when used to monitor a worker,
- Not be placed into shirts, coveralls or jacket pockets unless the pockets are specifically designed to hold portable gas monitors (i.e., mesh pocket),
- Be recharged in a safe area, away from the area being monitored, and
- Contractor workers shall know the limitations of the monitoring equipment used and include this information in their site specific training to all persons entering the work site.. Of special emphasis are the common limitations during cold weather operation. Of special note:
 - Most manufacturers of gas detectors place the design lower limit at -10 to -20 °C (14 to -4 °F)
 - Liquid Crystal Display (LCD) screens will dim at temperatures from -15 to -25°C. (5 to -13 °F) Keeping the monitor inside your coat and attaching a pump will allow you to still read the screen
 - The chemical reactions that occur in the gas detector begin to slow down at temperatures below -20°C (-4 °F) longer monitoring is required to get a good reading
 - Use of a hand warmer in the gas detector carrying case will help speed the reactions slightly, they will keep the LCD screen reading longer and they will help speed up the chemical reactions
 - At temperatures -35 to -40°C (-31 to -40 °F), it is recommended to take a sample to the gas detector in a warm well ventilated building

Personal Monitor use during escort - a personal monitor may be used on a person and for other individuals (when/where a monitor is required); when they are being escorted for the purposes of site tours, “walk arounds” or tasks requiring minimal to no hazards in the general area. The individual is to remain in close proximity of the escort at all times.

Area monitor use:

Area monitors can be used to supplement the need for personal monitors where personal monitors are not mandated or based on Atmospheric Monitoring and the Hazard Assessment.

Contractor Additional Requirements:

Contractor shall provide appropriate Atmospheric Monitoring and detection equipment unless otherwise noted within the bid documents or at the Request for Proposal (RFP), or at the pre-job meeting.

When necessary, specific atmospheric hazard measurement devices shall also be provided by the Contractor, e.g., if mono-styrene, acetone, benzene or other hazards are present. Company shall inform the Contractor when there is the potential for respiratory hazards or contaminants that may not be detectable by standard 4 contaminant monitors.

Alarm Events

The following actions shall take place when a monitor alarms indicating a potentially IDLH condition (“High” Alarm) in the work area:

- Contractor workers shall place their work in a safe condition, notify workers working in their immediate area of the alarm and exit the space or work area,
- An accounting of all Contractor personnel and other persons known to be at the work site shall be completed to verify that all workers have safely exited the work area,
- Initial air monitoring procedures shall be completed prior to re-entry into the work area or space, and
- The source causing the alarm shall be investigated where the source is either eliminated or controlled prior to re-entry. Note that in confined spaces the permit may need to be reissued, refer to the confined space specification.

3.1.1 PERSONAL AND AREA GAS MONITOR DEVICE REQUIREMENTS

Alarm Set Points

The alarm set points of gas monitors shall be set in accordance with Table 1 (exception: where manufacturer recommendations, local regulations, and/or local safety representative input dictates otherwise).

Table 1-Portable Gas Monitor Alarm Set Points

	H₂S	LEL	CO	O₂
low alarm	10 ppm	10% LEL	25 ppm	19.5%
high alarm	20 ppm	20% LEL	100 ppm	23.5% (US) 23% (Can)

Safety (the local safety representative for Company (Safety Advisor or Safety Inspector)) shall be consulted prior to changing the above set points due to abnormal work situations where the set points need to be expanded.

Personal Gas Monitors

Personal gas monitors shall:

- Have 4-head functionality - O₂, CO, LEL and H₂S,
- Provide a visual and audible alarm that is equipped with low and high alarm points.

Area Monitoring

A personal gas monitor may be used (in a limited capacity) to monitor an area for potential contaminants. In general the monitor (when used) should be used conservatively; where it would predict worst case conditions for a worker or other person if said individual were to be in that general area (i.e. remote sampling a confined space with a pump attached to the monitor, monitoring the face of an open pipe to represent worst case conditions).

Area Monitor

An area monitor is a gas monitor designed to be and work in a fixed location over a period of time and provide early warning to workers. To best represent worker exposure the monitor is positioned in the environment in such a way to represent the worker’s breathing zone during the work activities and in general is located nearer to the hazard than the workers to provide early warning.

Area monitors shall:

- Be capable of monitoring the potential atmospheric hazard,
- Be equipped with a visual alarm,
- Be equipped with an audible alarm, and
- The initial hazard assessment and scope of work shall determine the use of area monitors in addition to personal monitors; Examples of where the use of area monitors should be considered:

- Confined spaces
- Open systems
- Venting systems
- Leak sites
- Hazardous Areas
- Restricted Areas
- When actively working within 30m (100ft.) of Ground Disturbance work which is taking place within 3m (10ft.) of operating facilities (e.g., gas or oil pipelines, above or below ground); in such cases, there shall also be continuous gas monitoring, as determined by the Hazard Assessment

3.2 SAMPLING EQUIPMENT

Sampling equipment shall:

- Be capable of sampling according to the potential hazard, and
- Be positioned within 1 meter (3 feet) of the work area and not interfere with the task, including:
 - At the source of the gas or vapor,
 - Low areas (for petroleum vapors and hydrogen sulphide), and
 - The most representative location for workers at the site.

When using grab sampling equipment such as detector tubes (e.g., Drager CMS) and photo ionization detectors (e.g., UltraRae) Workers shall:

- Obtain multiple grab samples to obtain representative exposure information,
- Always follow standard guidelines for testing time limits and specifications as defined by the manufacturer, testing laboratory, or the United States National Institute of Occupational Safety and Health Analytical Methods Guidelines, and
- If alarms are activated indicating potentially dangerous levels of a chemical prior to specified length of time for measurement being completed, follow guidance under the section "Alarm Events".

3.3 INITIAL ATMOSPHERIC MONITORING

Initial atmospheric monitoring shall be completed by the Contractor when the initial hazard assessment identifies the potential presence of atmospheric hazards in the work area. When Company workers will be completing work or doing work in an area with a contractor, a Company representative, within their discretion, shall have the right to complete and document the initial atmospheric monitoring. If the contractor is solely doing the work, the contractor shall ensure that initial atmospheric monitoring is completed and documented. Documentation of completion of the monitoring shall be made available to a Company representative upon request.

Respiratory Protection Equipment (RPE) Requirements:

RPE requirements for initial atmospheric monitoring shall include a Self-Contained Breathing Apparatus (SCBA) when one of the following conditions has the potential to exist in the work environment:

- The work environment is an untested confined space and requires the worker to enter and test the space (note, refer to the specifics in the confined space specification, remote testing prior to entry is the preferred method of testing the air quality of a confined space prior to entry),
- There is an unknown chemical or contaminant,
- There is an oxygen deficient atmosphere, and
- There is a known chemical or contaminant with the potential to produce an IDLH atmosphere.

RPE requirements for “routine” tasks or work environments (non-SCBA) completed on a reoccurring basis or for initial monitoring purposes of those tasks, shall be determined based on past IH monitoring and/or risk assessments; where it is determined that a potential IDLH atmosphere will not occur. A listing of recommended RPE requirements for common tasks or work environments is listed under the RPE specification.

During initial atmospheric monitoring workers shall document the initial Atmospheric monitoring results on the SWP, and if required based on the Hazard Assessment, document continuous Atmospheric Monitoring on the SWP at intervals determined by the Hazard Assessment

Prior to performing any work, Contractor workers shall conduct a minimum of one atmospheric test as needed for chemicals that may be of concern with the product per reference to the SDS. For example when benzene is of concern conduct a minimum of one atmospheric test for benzene with a grab sampling instrument or Photo Ionization Detector (PID).

Atmospheric tests shall be taken at the downwind side regardless of the atmospheric tester/operator position relative to the Open Systems

Atmospheric Monitoring for mercaptans with grab sampling equipment shall be completed when there is a presence of coker naphtha products

3.4 BUMP TESTING, CALIBRATION, AND MAINTENANCE OF EQUIPMENT

Contractor workers shall follow manufacturers’ specifications regarding servicing, bump testing and calibration.

Calibration and bump tests shall be documented either manually (tags) and/or electronically (device software). Documentation shall clearly identify the date and time that the instrument was calibrated, bump checked, or serviced and shall be retained according to Enbridge record retention policy.

Specific calibration gases used shall be determined based on the type of device, manufacturer recommendations, and the chemical being monitored. When selecting a calibration gas other than those recommended by the manufacturer; a gas that will produce a more conservative result (errors by overestimating exposure) shall be selected (ask the local Safety Advisor/IH for advice prior to selecting a non-manufacturer recommended calibration gas)

Contractors shall maintain bump test and calibration logs while working at company worksites and make the logs available at the request of the company.

Bump Testing:

- Bump tests shall be performed in accordance with the manufacturer's specifications and/or more often as needed (where there are errors with the device or operational drift), and
- Instruments that fail a bump test, shall be given and pass a full calibration before using it.

Calibration:

- Calibration shall be completed at the frequency indicated in the manufacturer's specifications,
- Instruments that fail a full calibration shall be tagged as defective and removed from service; and
- A tag (or label) shall be attached detailing the calibration record for multi-gas monitors and grab sampling equipment when shared with a group of Workers.

4.0 TRAINING

Contractor workers who have been determined to perform atmospheric monitoring duties must be trained in the following elements:

- Functional bump testing and calibration of instruments,
- Multi-head gas detectors/personal gas detector usage,
- Instantaneous grab sampling equipment,
- Instrument service logging,
- Operational use as per the manufacturers specifications, and
- Limitations of personal gas monitors.

5.0 REFERENCES

Occupational Safety and Health Administration (OSHA)

- 1910.1000 Subpart Z Toxic and Hazardous Substances
- 1910.134 Respiratory Protection
- OSHA Technical Manual

Canada Labour Code, Part II; Canadian Occupational Safety & Health (COSH) Regulations,

- 10.1 Hazardous Substances
- 12.7 Respiratory Protection

International Safety Equipment Association

- Statement on Validation of Operation for Direct Reading Portable Gas Monitors

National Fire Protection Association

- NFPA 30 Flammable and Combustible Liquids Code

<End of Document>



LP Contractor Safety Specification

Aviation – Personal
Safety

Table of Contents

1.0	Definitions & Acronyms.....	2
2.0	Contractor Responsibilities	2
3.0	Contractor Specification-Specific Requirements.....	4
3.1	Pre-Flight Briefing	4
3.2	Helicopters	5
3.2.1	Operational Hazards	5
3.2.2	Planning For Helicopter Operations	6
3.2.3	Staging Locations.....	6
3.2.4	Contractor Personal Protective Equipment	7
3.2.5	Contractor Ground Crew Communication Requirements	8
3.2.6	Entering A Helicopter	9
3.2.7	Exiting A Helicopter	9
3.2.8	Entering Or Exiting A Hovering Helicopter	10
3.2.9	Slinging Operations	10
3.2.10	Contractor Lifting Requirements.....	12
3.2.11	Contractor Spotter Requirements For Helicopter Lifts.....	13
3.2.12	Contractor Helicopter Fuelling Considerations	14
3.3	Unmanned Aircraft Systems	15
3.3.1	Operational Hazards	15
3.3.2	Planning for UAS Operations	16
3.3.3	Contractor Personal Protective Equipment	16
3.3.4	Contractor Crew Communication Requirements	17
3.3.5	Contrator Spotter (Visual Observer) Requirements.....	17
3.4	Transport Of Hazardous/Dangerous Goods By Air	18
3.5	Emergencies	18
3.6	References.....	19

1.0 DEFINITIONS & ACRONYMS

Aviation Authority—means the civil aviation authority (Transport Canada in Canada or the Federal Aviation Administration in the US) in the country in which the operator or Contractor is based and providing services.

Aviation Regulations— means the rules prescribed by the governing aviation authority which apply to aviation services being conducted by a carrier.

Carrier—means a commercial charter air carrier who has been authorized by the appropriate Aviation Authority to provide flight operations for compensation, hire, or reward.

ELT—Emergency Locator Transmitter.

Enbridge—Enbridge, Inc. and Enbridge (U.S.) Inc., hereinafter will be referred to as “Company”.

FAA—Federal Aviation Administration.

Flight Crew—the person or persons responsible for the control and operation of the aircraft and its intended flight.

IATA—International Air Transport Association. *RPAS*—

Remotely Piloted Aerial / Aircraft System. *UAS*—Unmanned Aircraft System.

UAV—Unmanned Aerial Vehicle.

2.0 CONTRACTOR RESPONSIBILITIES

Contractor Leadership shall:

- Ensure contractor workers are familiar with this Specification or have a Specification that meets or exceeds the expectations of this document, and
- Ensure or facilitate that appropriate work planning has been completed prior to helicopter operations.

Worker shall:

- Support the development and execution of the field level hazard assessment for all work to be completed as well as the expectations within this Specification.

Contractor Rigger shall:

Note: this role is performed by flight crew members including the pilot depending on the work activity and/or the aviation company/carriers policies and procedures. There may be opportunities where contractors will support this work activity and maybe responsible for the expectations listed below. Prior to work execution, they must receive training from the flight crew members. The pilot in command has final authority as to who rigs loads and how a load is rigged. When rigging personnel are provided by the carrier, contractor personnel will not be responsible for the duties listed below and will be present only to oversee operations and coordinate the lifts with the carrier's workers:

- Be trained for rigging helicopter loads and for overhead crane loading including load preparations, securement and procedures as per local/applicable legislation and/or carrier requirements,
- Inspect the safety devices of all rigging equipment or installed rigging devices on equipment to be lifted. Only the pilot in command or flight crew members shall test the lifting equipment and ensure it meets legislative and engineering requirements,
- Have experience consistent with the requirements of the lift to be made,
- Be physically and mentally able to accomplish required rigging tasks,
- Perform visual equipment inspections of rigging equipment to ensure cleanliness and that it is in good condition; remove all equipment from service that does not meet visual inspection until it can be verified to be in safe working condition in accordance with the manufacturer specifications, and
- Maintain a written record or log book of these inspections when applicable.

Contractor Spotter/signal person shall:

Note: The spotter's role may be performed by flight crew members depending on the work activity and/or the aviation company/carriers policies and procedures. When spotter/signalperson personnel are provided by the carrier, Contractor personnel will not be responsible for the duties below and will be present only to oversee operations and coordinate the lifts with the carrier's workers.

- Will be familiar with helicopter lift hand signals and consult with the pilot in command on his/her preference for hand signal use,
- Complete any specific training required by applicable legislation and/or as required by the company in charge of the lift. Consult with the pilot in command to ensure operations are understood and that requirements are clear,
- Wear appropriate PPE to distinguish themselves from other workers,

- Supervise the landing/loading area(s) to ensure personnel do not enter the area while lifts are happening and halt operations if a unauthorized entry is made,
- Observe and communicate on the movement of the load or communicate any other information the pilot in command may need to know by either hand signals or radio, and
- Ensure no personnel are stationed in the flight path of a suspended load taking-off and/or being landed.

Contractor Helicopter pilot shall:

- Be familiar with the requirements of this Specification along with the safety Specifications for charter air carriers.

Contractor Visual observer (UAS):

- Review the *Visual Observer Briefing* document and communicate any concerns directly with the pilot verbally,
- Follow the instructions of the pilot in command at all times, and
- Assist the pilot with keeping the landing/take-off area clear when not required to be observing the UAV or during emergencies.

Contractor UAS pilot:

- Ensure that you have reviewed the *Visual Observer Briefing* with your visual observer and that they clearly understand their role, and
- Ensure that you have established a communication protocol with the visual observer.

3.0 CONTRACTOR SPECIFICATION-SPECIFIC REQUIREMENTS

A documented field level hazard assessment must be completed between the pilot and designate ground crew for work activities using a helicopter for long-lining or other material transportation requirements.

Prior to entering any aircraft, ensure the pilot provides an orientation on the safety features of the helicopter or plane and discusses operational hazards and emergency procedures specific to the aircraft being used.

3.1 PRE-FLIGHT BRIEFING

The pilot or flight crew shall conduct a thorough and documented passenger briefing with all passengers before their first flight, which includes, as a minimum, the following:

- Procedures for boarding and exiting the aircraft including any dangers associated with the aircraft type,

- Training on safe use and the dangers of the improper use of the aircraft's equipment, if passengers will use the doors, cargo compartments or helicopter basket,
- Potential dangers of the turning main rotor and turning tail rotor when applicable (in the case of helicopters),
- Potential dangers of jet engines or turning propellers when applicable (in the case of fixed wing aircraft),
- Location and use of emergency and lifesaving equipment required to be carried, such as, life preservers, life-raft, portable fire extinguishers, first-aid kits, and survival gear,
- Location and explanation of the proper use of the emergency locator transmitter (ELT), and
- SMOKING is NOT permitted on any Company flight.

3.2 HELICOPTERS

3.2.1 OPERATIONAL HAZARDS

The greatest hazards associated with helicopters are the spinning main and tail rotor blades, the exhaust and the downwash. Spinning helicopter rotor blades can be difficult to see and may vary in their height above the ground. In addition, they create a strong rotor downwash, produce high noise levels and can generate static electricity. When on or near the ground, the helicopter produces downwash that can recirculate air as well as foreign objects back down through the main rotor systems. Loose objects must be secured on the ground to prevent them travelling through the main or tail rotor which can cause loss of control of the helicopter and lead to catastrophic mechanical damage as well as injuries up to and including death. The downwash is capable of knocking a person over. It can also dislodge vegetation, objects or debris which may pose a threat either to people on the ground or to the helicopter itself.

Helicopter rotor blades can generate static electricity. In moist or dry snow air conditions, static electricity can build up on the helicopter. This static electricity will be discharged when the helicopter contacts ground or any of the helicopter attachments come into contact with the ground. This is not a hazard to those on the helicopter unless a passenger steps down from a hovering helicopter, which creates a path to ground.

Static electricity shock is a threat to workers who come into contact with the aircraft or with its attached sling gear before the charge has had a chance to dissipate; allowing the aircraft longline or sling gear to touch the ground before handling it will dissipate the charge to ground and can eliminate the risk of electric shock.

3.2.2 PLANNING FOR HELICOPTER OPERATIONS

In planning the layout of a work site, the following minimum information must be considered when developing the pre-job or project plan:

- Planned approach and departure paths with consideration of prevailing wind patterns and built up areas if applicable (i.e., departure or approach near homes or farms with livestock),
- Location of work areas for the various elements of the operation,
- Location of emergency landing areas,
- Location of landing areas,
- Location of separate service and refuelling areas,
- Location of any travelled roadways, and
- Location of any potential hazards such as power lines or tall trees.

Workers must be informed of the work plan as well as the helicopter flight path to and from the helipad and/or landing zones. Flight paths and operational areas must be kept clear of equipment or personnel other than the flight personnel necessary to assist in landing and take-off.

Workers must not be placed in an area where there are overhead hazards.

3.2.3 STAGING LOCATIONS

When determining the location(s) for staging lifting operations or medical evacuation helipad sites, there are several best practices to incorporate prior to commencing operations.

3.2.3.1 General

Landing sites must have sufficient clearance for the main and tail rotors. Landing sites are to be on level ground with less than 5% slope and at least 36 X 36 meters (120 X 120 feet). This area will need to be expanded for use of multiple or larger helicopters and if the location is to be used as a staging site for fueling and/or lifting operations.

If applicable, road blocks will be required approximately 500 meters (1650 feet) on either side of the landing site.

Loose materials, garbage and other debris must be removed from the site or secured appropriately.

A windsock must be located in a location that is visible to the pilot.

3.2.3.2 Contractor Medical Evacuation Staging Sites Training

Note: Enbridge Aviation and contracted air carriers staff are not qualified to provide anything more than first aid assistance for emergency medical evacuation if no other options are available.

This section provides the general information that a contracted air emergency medical services provider would require to support any medical evacuation requirements for a region or project.

The Contractor shall ensure that all landing sites designated for medical evacuation are registered with the appropriate emergency response provider in the region or project area.

When registering a landing site or calling for a medical evacuation, be prepared to provide the following information:

- Location site number (if previously registered with the response provider),
- Legal land description and GPS coordinates,
- Contact person and phone number at the location site,
- Known hazards on the site location,
- Confirmation of an on-site monitor for H₂S and other potential respiratory hazards on site as applicable, and
- Confirmation of landing zone markings required for day and night landings.

See the *Emergency Preparedness (Personal) Specification* for additional requirements specific to emergency response planning.

3.2.4 CONTRACTOR PERSONAL PROTECTIVE EQUIPMENT

When working with helicopters, ground crews are required to wear the following personal protective equipment:

- Approved safety footwear,
- High visibility garment,
- Approved hard hat with a chin strap,
- Face shield or safety goggles where dust and flying debris may be present,
- Hearing protection, and
- Hand protection (avoid use of gauntlet gloves as they can be snagged by rigging).

It is recommended that the ground crew also have clothing that provides suitable protection against the weather.

Workers travelling inside a helicopter must use the headsets attached to the intercom system of the helicopter (if provided), so the pilot in command can communicate with them. This will require that hardhats are removed so that headsets can be worn. When headsets are not provided, appropriate hearing protection is required.

Workers travelling to remote sites (helicopter access only) in the helicopter must ensure that they have the necessary communication, high visibility clothing, survival and first aid gear with them to survive in case the helicopter becomes unserviceable or cannot return to pick them up (if dropped off) due to weather or other problems.

3.2.5 CONTRACTOR GROUND CREW COMMUNICATION REQUIREMENTS

Good communication between the pilot and the ground crew is vital for carrying out helicopter operations in a safe and efficient manner. Before helicopter operations begin, the supervisor and ground crew must meet with the pilot in command to establish:

- Plans and procedures to be used,
- Ground-to-helicopter communication systems,
- Corrective measures required to minimize risks of injury to workers,
- Limitations and capabilities of the helicopter, and
- Guidelines for the safe use of equipment associated with the helicopter operation.

Communication between the pilot and ground crew should be established by implementing the following minimum requirements:

- Established effective system of visual communication signals between the pilot and the ground crew (noise may prevent verbal communication),
- If available, two-way radio communication equipment shall be tested and the channels to be used established before operations begin. This is essential for helicopter operations,
- Established exact voice or hand signal commands to avoid any possibility of misunderstanding: all communication should be pertinent and brief,
- If two-way communication is available, included helicopter identification in any command given to direct flight movement,
- A distinctive high-visibility vest or jacket to be worn by the worker who is in radio contact with the pilot,
- Clearly marked location of cables and all known hazards in the way of anticipated flight paths on the plans, and make the pilot aware of them, and
- Confirmed visual and verbal signals will be used before starting the operation.

Please see appendix for more information on visual signals for helicopter operations.

3.2.6 ENTERING A HELICOPTER

Passenger entry and exit will only be completed when the aircraft rotor system is either stopped or is running at 100 percent. No passenger movement will be allowed while the aircraft rotor system is starting or stopping. No passenger shall board the helicopter if they have not had the pilot briefing or are not familiar with the specific helicopter.

If entering while the helicopter is running establish contact with the pilot. Position yourself where the pilot can see you. Maintain visual contact with the pilot (wear goggles if dust is a hazard).

After being signaled by the pilot, approach the helicopter in the preferred direction (i.e. from the front within line of sight of the pilot) if possible. Walk, do not run. Enter the helicopter one person at a time. NEVER approach from behind the helicopter because of the risk of being struck by the tail rotor, or being burnt by exhaust. In addition, the pilot cannot see you.

If the helicopter is on a slope, approach from the downhill side. Never approach from uphill descending down toward the helicopter.

If blinded by swirling dust or grit, STOP, crouch low and wait for assistance (if it is safe to do so).

Approach the helicopter in a crouching manner for extra rotor clearance. NEVER reach up to grab clothing or other articles that have blown away.

Do not grab any part of the aircraft unless it is a door handle, if you grab or touch antennas or flight control instruments you may be hurt or possibly damage the aircraft (i.e. pitot tubes are normally VERY hot and will burn you instantly if you touch them).

Carry any tools or equipment horizontally below waist level—NEVER upright or on your shoulder.

NEVER BRING BEAR SPRAY INTO A HELICOPTER. If you must carry it for work purposes, notify the pilot and ensure that it is stored properly for transport as per the pilot's directions.

Once you have reached the helicopter, you will be instructed where to sit. Once seated, fasten and adjust your seatbelt. Ensure that the door is properly closed behind you. When you are seated, with seat belt fastened, and the door has been closed, let the pilot know that you are ready for flight.

3.2.7 EXITING A HELICOPTER

Passenger entry and exit will only be completed when the aircraft rotor system is either stopped or is running at 100 percent.

If you must exit while the helicopter is running remain seated, with seatbelts fastened until instructed by the pilot to disembark.

On exiting the helicopter, remain beside the helicopter (within the pilot's line of sight if possible and very close to the helicopter) until all passengers have disembarked; ensure that: doors are closed properly; any external cargo has been collected; and the cargo compartments are properly closed. Training on proper use of doors and the cargo compartments will be done by the pilot-in-command in the pre-flight briefing.

Exit the helicopter to the front, staying within the pilot's line of sight. Remember to exit in a downhill direction, if possible, and to crouch when under the rotor diameter. If the passengers are not able to get outside the rotor diameter after exiting the helicopter, a plan will be discussed with the pilot in command with a procedure that will be followed for the departure.

Once all passengers are outside the rotor diameter (if possible) and have reached a safe area, one designated person should signal the pilot that he is clear to leave (this should be a signal that is discussed and agreed upon in the pre-flight briefing). Before giving the signal for the pilot to depart, the designated signaling person will scan the area for any potential hazards that may be present (i.e. garbage, unsecured cargo, forgotten cargo, doors not closed etc.).

Ensure that you are wearing your PPE when the helicopter departs; if you are close to the helicopter, there will be a very strong wind blast as well as sand/dirt/grit flying around, so eye protection is important, and crouching is advised to maintain balance.

These procedures shall be discussed in detail with the pilot in command if the helicopter is going to be running when the passengers get out. A rehearsal of the event before departure (with the helicopter stopped) may be conducted so that everyone is clear of their responsibilities.

3.2.8 ENTERING OR EXITING A HOVERING HELICOPTER

This procedure is an extremely high risk operation and should only be used in cases where no other entry/exit options exist.

Anyone who will be exiting or entering the helicopter while hovering will be trained in this procedure by either a trained and endorsed pilot or by a training center. Training for hover exit/entry will be conducted prior to anyone performing this operation in a field location and proof of current training made available.

3.2.9 SLINGING OPERATIONS

Workers working around helicopters during slinging operations shall:

- Keep the area free of loose articles,
- Watch for hazards, such as obstacles or hanging trees that may fall when dislodged by the helicopter rotors or by gusty wind conditions,
- Stay alert and be aware of the positioning of loads,
- Maintain visual contact with the load (and cargo hooks) until it clears the location,

- Keep a safe distance from the loads,
- Remain clear of incoming loads (and cargo hooks) until they are placed on the ground,
- Determine an escape route that leads away from the load, and ensure it remains clear of objects or potential blockages,
- Always stand uphill from the load, as it may roll when released, and
- Maneuver the load only when absolutely necessary and only by pushing it into position; do not reach for a load or cargo hook.

For all helicopter lifts, the minimum control measure required shall be a field level hazard assessment (FLHA) that addresses:

- Expectations and responsibilities of all parties involved with the slinging operation,
- Identified traveled path(s) of the helicopter,
- Hazards and controls associated with the work area,
- Identification of the designated riggers and spotters/signalperson to other workers involved,
- Agreed upon lift hand signals,
- Agreed upon means of communication between the pilot and rigger/spotter/signalperson,
- Lift zone and all potential drop zones, and
- The requirement to not walk or pass under a suspended load or enter the area between the load and a stationary object.

Drop zones or landing areas should be sufficiently large enough in order to prevent equipment from contacting trees or other obstructions while spotting or lifting.

Note that for all long line activities, ground personnel must keep a minimum 200 foot (61 meter) safety zone from the helicopter while it is lifting or landing a load at a staging site. This distance may need to be increased based on the length of the long line being used. The safety zone is determined by multiplying the long line length by 2X. This requirement must be documented within the field level hazard assessment prior to work commencement.

Landing areas shall be constructed with adequate blade clearance, proper footing for the type of helicopter being used, and include consideration for the direction of approach the passengers will use if loading is conducted with the helicopter running. They also should be located in a manner so the helicopter can always lift 'into the wind direction'.

The carrier shall conduct on-the-job safety meetings and crew briefings on a regular and scheduled basis.

3.2.10 CONTRACTOR LIFTING REQUIREMENTS

The pilot in command must be consulted and authorize all lifts including set up of the loads and the rigging of the lifts.

Note: The air carrier is responsible for providing all lifting equipment for helicopter operations. When inspecting an air carrier's equipment, Company in no way assumes responsibility for the serviceability/safety of that equipment. These inspections and instructions are only provided as an added level of safety, so all workers have a better level of understanding of the equipment. The aim of these recommendations is that all workers would feel informed and confident enough to question the air carrier on the condition of their equipment.

For slinging and/or helicopter lift operations, follow these recommendations:

- Use only purpose built helicopter longlines which can be made from various materials from synthetic fabrics to steel,
- All long lines and lanyards must be in good condition and not show signs of excessive wear. Normally long lines will have a metal tag indicating the year of manufacture, manufacturer and load limitations. Any doubt on condition is to be addressed with the pilot in command and lifts are not to be authorized until serviceability can be assured,
- Lanyards or endless straps will have tags or a sewn-on information decal indicating useful load, manufacturer and date of manufacture. Consult with the pilot in command if there is any doubt of the condition of any equipment used in helicopter lifting operations. If there is any disagreement on condition of the equipment, do not authorize the lift until all doubt of condition of the equipment has been removed,
- Attach only properly-sized clevises or pear rings, with the proper weight rating to the helicopter hook (either the belly hook or the extended hook) and keep all screw-type clevis pins tight and a safety device installed (i.e., lock wire, ty wrap, etc.),
- Use only the proper type of clevis pins (not bolts) and visually check clevises before and after each lift,
- If the carrier does not already have a record keeping system in place, record the equipment inspections,
- Visually inspect cargo nets for condition. Excessive fading, lack of identification tags, broken strands, and excessive wear caused by excessive use or age are cause for rejection of the net. No lifts are to be conducted if the serviceability of the net cannot be assured,
- Secure loads of loose articles in cargo nets,
- Advise the pilot of the presence of any hazardous materials,

- Do not conduct long line operations over populated areas,
- Do not conduct long line operations within 100 m (110 yd.) of high-voltage power lines,
- Cease operations during electrical storms,
- Ground all loads to prevent a buildup of static electricity (static prevention is meant to prevent possible electrical injury to spotters),
- Before commencing slinging operations, designate one person as the spotter and if two-way radio communication is available, ensure that radio frequencies are established.
- No workers shall be passengers or deemed essential crew during lift operations,
- All clevises on auxiliary equipment shall be secured (i.e. safety pin, lock-wired or tie- wrapped) in order to prevent inadvertent release,
- All auxiliary equipment (hooks, line, clevis, etc.) shall be visually inspected prior to use and thereafter on a regular basis,
- The line attached to any helicopter hook, either belly mounted or remote, shall be fitted with a properly sized clevis or ring and have no more than one (1) lanyard attached (i.e. multiple-hook sling loads shall NOT be attached directly to the helicopter hook),
- Any external load that has the possibly of turning in flight shall be fitted with a ball-bearing swivel and be fitted with a drogue chute or similar device to control directional stability of the load,
- Complex lifting devices (i.e. carousel, bag-runner, extended electric hook) shall have detailed inspection procedures, including a documented annual inspection.

3.2.11 CONTRACTOR SPOTTER REQUIREMENTS FOR HELICOPTER LIFTS

The spotter is the only person permitted to stand beneath the helicopter during slinging operations unless another person is required to help position the load.

The spotter is the only person permitted to use hand signals.

The spotter shall:

- Use Specification hand signals (or signals discussed with, and agreed to in advance by the pilot in command) when the helicopter is operating directly overhead and when it is impossible to use radio communication,
- Confirm that the pilot has visual contact of the spotter by radio prior to using hand signals,
- Be in constant radio communication with the helicopter pilot whenever possible,

- Ensure Specification helicopter hand signals are practiced and agreed upon prior to the start of operations,
- Use large movements when using hand signals, especially when using long lines,
- Wear head protection with chin strap,
- Wear protection from static (e.g., high-voltage gloves) during cold weather/low humidity,
- Wear eye and ear protection appropriate for the task,
- Wear a distinctive high-visibility vest or jacket to distinguish themselves from other workers,

The following Specification hand signals shall be confirmed with the pilot and spotter prior to work execution and utilized appropriately during all lifting or slinging operations:

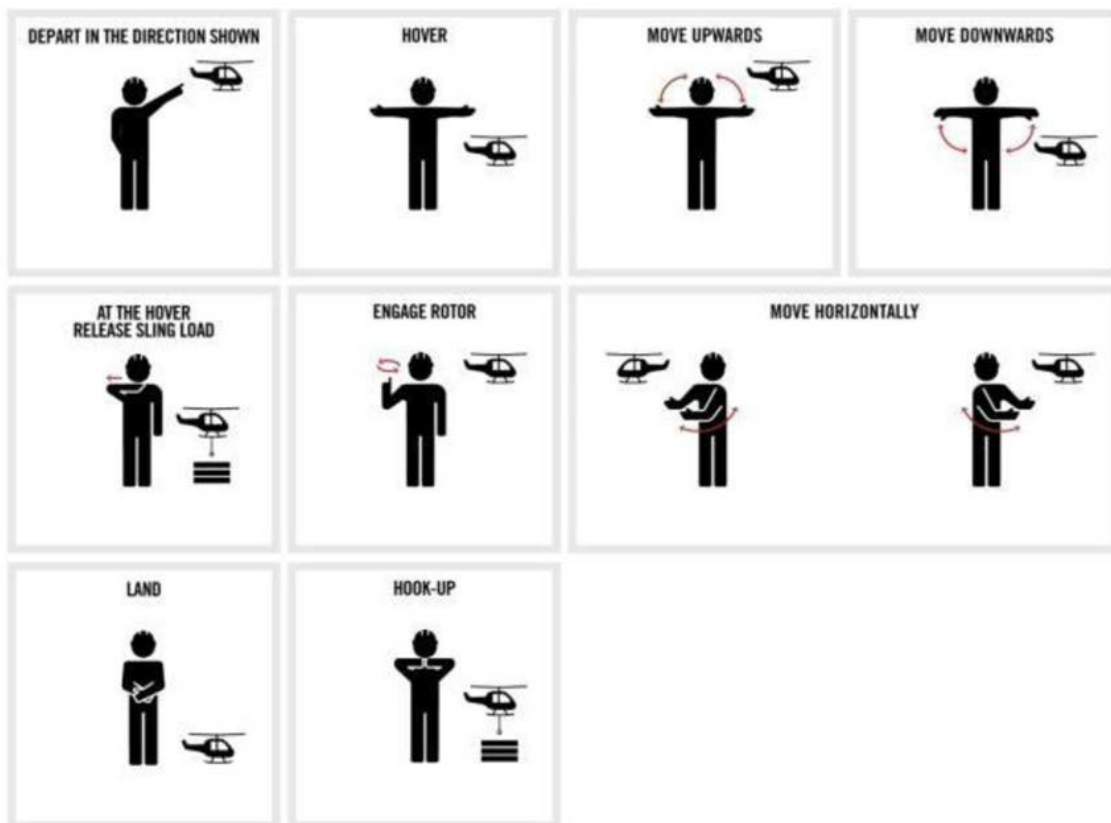

3.2.12 CONTRACTOR HELICOPTER FUELLING CONSIDERATIONS

Only the pilot is allowed to remain in the helicopter during refueling. The helicopter shall be electrically bonded to the bulk fuel tank, barrel or vehicle during refueling. Refueling will only

be accomplished with the helicopter engine shut down and the rotor stopped. “Hot” or engine running refueling is not authorized.

The flight crew is the only personnel who can assist or perform fueling duties.

At least one 20BC minimum rated portable fire extinguisher shall be in the immediate area.

No smoking or spark producing activity shall be permitted within 15.2 meters (50 feet) of fuel storage barrels or refueling operations.

Fuel storage location sites must meet or exceed all local environmental, health and safety requirements within the project or regional operating area.

Housekeeping of fueling sites during operations must be maintained to the highest level, downwash can cause lighter items to move and become hazardous to both the helicopter and ground crew. For example, empty drums should be stored away from the landing area and spill containment berms that hold fuel barrels must be sufficiently weighted to hold them down.

Fixed Wing Aircraft

When approaching and departing from a fixed wing aircraft stay in the pilot’s field of view at all times. Approach only when the pilot indicates that it is safe to do so.

Caution: The safety zones for approaching a fixed wing aircraft are different than for helicopters. Never approach the airplane while running unless instructed to do so and shown safe approach angles.

Always beware of the propellers, particularly when engine/s is idling during warm up and brief stops to load or unload passengers, materials or equipment. Never touch the propeller of a reciprocating/piston engine aircraft as the engine can turn over if the ignition switches are left on or are faulty. Never touch any part of the airplane unless instructed to do so by a crew member.

The pilot is responsible for correct weight and balance of the aircraft. Only assist with loading heavy or bulky equipment or materials under the pilot’s supervision.

3.3 UNMANNED AIRCRAFT SYSTEMS

Unmanned aircraft systems present a unique environment for personal safety that touches both traditional aviation and ground based operations personal safety.

3.3.1 OPERATIONAL HAZARDS

UAVs have high RPM plastic or carbon fibre propellers that can cut human flesh to the bone in an instant. Do not approach a UAV unless the pilot advises that the controls are secure and that it is safe to approach. The landing/take off area for the UAV will be clearly delineated with cones and appropriate signage. UAS may quickly return to land if a loss communications occurs. Listen to the instructions given by the pilot in command and ensure you stay clear of this area.

Do not stand beneath a hovering UAV. A battery failure could cause the UAS to drop very rapidly and strike a person on the ground.

Lithium Polymer (LiPo) batteries must be protected from physical damage and the contacts protected from short circuit. These events can cause very intense fires that are difficult to extinguish with traditional methods.

3.3.2 PLANNING FOR UAS OPERATIONS

In planning the layout of a work site, the following minimum information must be considered when developing the pre-job or project plan:

- Planned take off/landing areas and approach/departure paths with consideration of prevailing wind patterns, mechanical turbulence, built up areas, and obstacles if applicable (i.e., departure or approach near homes or farms with livestock),
- Location of work areas for the various elements of the operation,
- Location of emergency landing areas,
- Location of landing areas,
- Location of any travelled roadway,
- Location of any potential hazards such as power lines, buildings, structures, or tall trees, and
- Known sources of potential radio interference (EMI/RFI).

Workers must be informed of the work plan as well as the helicopter flight path to and from the helipad and/or landing zones. Flight paths and operational areas must be kept clear of equipment, or personnel other than flight personnel necessary to assist in landing and take-off.

Workers must not be placed in an area where there are overhead hazards.

Detailed UAS operations planning for pilots can be found in the Company UAS Operations Manual.

3.3.3 CONTRACTOR PERSONAL PROTECTIVE EQUIPMENT

When working with UAS, the pilot and visual observer are required to wear the following personal protective equipment:

- Approved safety footwear,
- Class 2 HVSA to distinguish themselves from other workers,
- Approved hard hat with a chin strap,
- Face shield or safety goggles where dust and flying debris may be present, and
- First Aid kit.

It is recommended that the pilot and visual observer also have clothing that provides suitable protection against the weather.

3.3.4 CONTRACTOR CREW COMMUNICATION REQUIREMENTS

Good communication between the pilot and the ground crew is vital for carrying out helicopter operations in a safe and efficient manner. Before UAS operations begin, the visual observer, supervisor and workers involved in the operation must meet with the pilot in command to establish:

- Plans and procedures to be used,
- Corrective measures required to minimize risks of injury to workers,
- Limitations and risks associated to the UAS,
- Communication between the pilot and ground crew should be established by implementing the following minimum requirements:
 - Establish an effective system of voice communication signals between the pilot and the visual observers/ground crew (noise and distance may prevent verbal communication),
 - If available, two-way radio communication equipment shall be tested and the channels to be used established before operations begin. This is essential for UAS operations where direct verbal communications is not possible,
 - Established exact voice or hand signal commands to avoid any possibility of misunderstanding: all communication should be pertinent and brief,
 - Clearly marked location of cables and all known hazards in the way of anticipated flight paths on the plans, and make the pilot aware of them.

3.3.5 CONTRATOR SPOTTER (VISUAL OBSERVER) REQUIREMENTS

The visual observer is an integral part of the UAS ground crew. Their role is to keep the pilot informed of other aircraft that could potentially enter the UAS flight operations area and to advise the pilot of any hazards that the UAV may be getting too close to or have the potential to cause a flight safety occurrence.

The visual observer shall:

- Remain within direct voice contact with the pilot at all times (by radio if remaining in close proximity to the pilot is not possible while performing their duties),
- Maintain visual contact with the UAS at all times with no exception, and

- Not perform any other duties other than those detailed in the Visual Observer briefing. They must not be distracted by other workers or activities that would take attention away from their primary duties. It only takes a few seconds for a UAS to come in contact with an obstacle when operating in complex environments.

3.4 TRANSPORT OF HAZARDOUS/DANGEROUS GOODS BY AIR

Company Aviation does not transport hazardous/dangerous goods by air. If using a contracted carrier, the carrier must, at all times, hold the appropriate approval from the aviation authority in order to transport hazardous or dangerous goods by air for Company.

In the absence of aviation regulations that set a more stringent Specification, the carrier must accept, handle, load, and transport hazardous or dangerous goods in compliance with the IATA Regulations (International Air Transport Association).

The pilot in command **MUST** be informed of any dangerous goods cargo before the start of the flight.

Lithium Polymer (LiPo) batteries used in UAS are considered dangerous goods. Check with the UAS program manager if you are not sure if a particular UAS or UAS battery can be shipped or transported by air and what paperwork may be required.

3.5 EMERGENCIES

During an emergency, follow any instructions issued by the pilot.

Check that any loose gear in the cabin is secured and put on a helmet if provided. Remove eye glasses and put them in your pocket. Loosen your collar and assume the brace position.

Tighten your seat belt.

With shoulder straps: tighten and sit upright, knees together, arms folded across your chest.

Without shoulder straps: bend forward so your chest is on your lap, head on knees, arms folded under thighs.

In the case of a UAV Fly-Away, maintain visual contact as long as possible while noting the height, direction of travel and the speed of the UAV.

If the UAV strikes the ground after a flight accident, keep the area around the UAV clear due to the LiPo battery fire hazard. Do not approach or touch the UAV. The pilot will initiate the emergency response plan and advise further action.

3.6 REFERENCES

Occupational Safety and Health Administration (OSHA) Act

Section 5, Duties Canada Labour Code, Part II:

Canadian Occupational Health & Safety Regulations, Hazard Prevention Program; Part XIX

Federal Aviation Administration:

Part 133 External Load Operations FAA Part 133 Operations

ASME B30.12-2011 Handling Loads Suspended from Rotorcraft

<End of Document>



Contractor Safety Specification

Bloodborne Pathogens Exposure Control

Table of Contents

1.0	Definitions and Acronyms	2
2.0	Contractor Responsibilities	3
3.0	Specification Requirements	3
3.1	Preventative Measures	4
3.2	Decontamination	5
3.3	Disposal	6
4.0	Training Requirements.....	7
5.0	References.....	7

1.0 DEFINITIONS AND ACRONYMS

Bloodborne Pathogens—pathogenic microorganisms that are present in human blood and can cause disease in humans. These pathogens include but are not limited to the hepatitis B virus (HBV) and the human immunodeficiency virus (HIV).

Blood—human blood, human blood components, and products made from human blood.

Contaminated Laundry—laundry that has been soiled with blood or other potentially infectious materials.

Decontamination—the use of physical or chemical means to remove, inactivate, or destroy bloodborne pathogens on a surface or item to the point where they are no longer capable of transmitting infectious particles and the surface or item is rendered safe for handling, use, or disposal.

Enbridge—*Enbridge, Inc. and Enbridge (U.S.) Inc., hereinafter will be referred to as “Company”.*

Exposure Incident—a specific eye, mouth, other mucous membrane, non-intact skin, or parenteral contact with blood or other potentially infectious materials that results from the performance of a worker's's duties.

Handwashing Facilities—a facility providing an adequate supply of running potable water, soap, and single-use towels or air-drying machines.

HBV—hepatitis B virus.

HIV—human immunodeficiency virus.

Licensed Healthcare Professional—a licensed physician or other licensed health care professional whose legally permitted scope of practice allows him or her to perform the activities of Hepatitis Vaccinations and post-exposure evaluation and follow-up independently.

OPIM—other potentially infectious material.

Personal Protective Equipment (PPE)—specialized clothing or equipment worn by a worker or contractor for protection against a bloodborne pathogen hazard.

Regulated Waste—defined as:

- Liquid or semi-liquid blood or other potentially infectious materials,
- Contaminated items that would release blood or other potentially infectious materials in a liquid or semi-liquid state if compressed,
- Items that are caked with dried blood or other potentially infectious materials and are capable of releasing these materials during handling, and/or
- Any other material containing blood or other potentially infectious materials.

Source Individual—any individual, living or dead, whose blood or other potentially infectious materials may be a source of occupational exposure to the worker.

Universal Precautions—is an approach to infection control. According to the concept of universal precautions, all human blood and certain body fluids are treated as if known to be infectious for HIV, HBV and other bloodborne pathogens.

2.0 CONTRACTOR RESPONSIBILITIES

Contractor shall:

- Ensure that workers under their control are aware of and comply with this Specification.

Workers shall:

- Notify their supervisor immediately if they come into contact with blood or other body fluids through the provision of rendering first aid or through other means while on the job.

3.0 SPECIFICATION REQUIREMENTS

Universal precautions shall be used by workers who could potentially be exposed to any of the following:

- Blood;
- Bodily fluids containing visible blood;
- Other bodily fluids; and/or
- Used needles, scalpels and other sharp instruments.

Potential routes of exposure include:

- By injection or injury with contaminated injecting equipment (e.g. needle-stick injury) or other sharp objects.
- By transfusion with infected blood or blood products or the transplantation of infected material.
- By indirect transfer of infected blood through shared razors, toothbrushes and other personal items.
- Through mucosal contact (e.g. splashes of body substances to the mouth, nose, eyes or non-intact skin).

If potentially exposed to bloodborne pathogens while on the job, the exposed worker will be given the option to receive a confidential medical evaluation by a licensed healthcare professional. If

the exposed worker refuses a medical evaluation, the worker shall not be permitted to continue to provide first aid in the workplace until such time a licensed healthcare professional examines the worker and declares him/her fit to engage in the provision of first aid.

3.1 PREVENTATIVE MEASURES

Universal precautions must be observed when providing first aid or performing other duties, if contact with their blood or body fluids is possible, to prevent contact and potential infection. This includes the use of the following personal protective equipment which includes but is not limited to:

- Disposable non-sterile, latex or nitrile gloves;
- Disposable respirator/eye protection combination; and
- Resuscitation mask/micro-shield.

Examples of conditions warranting the use of this PPE includes, but are not limited to:

- Exposure to blood and other infectious materials;
- Exposure to mucous membrane and non-intact skin;
- Performing mouth-to-mouth resuscitation; and
- Handling or touching contaminated surfaces.

The use of PPE is also required when handling or touching surfaces contaminated by blood or bodily fluids.

Biohazard kits shall be provided in the standard first aid kits. The biohazard kit includes at least one of each of the following:

- Combination eye shield and mask;
- Pair of disposable latex gloves (extras should be kept on hand at stations);
- Sanitary hand wipe; and
- One-way valve mask for CPR.

A high standard of personal hygiene and the practical application of the steps listed below are essential to preventing infection to first aid responders and personnel requiring care.

- Hands must be washed and dried immediately after removing gloves (gloves cannot be guaranteed to prevent skin contamination and may not remain intact during use).
- Gloves must be removed and replaced when providing first aid to more than one worker.

- Protective eyewear must be worn where eyes and/or mucous membranes may be exposed to splashed or sprayed blood or other body fluids/substances.
- Cuts or abrasions on any part of a worker's body must be covered with appropriate dressings at all times as soon as possible.

A common infection hazard for workers is exposure to sharps (e.g., used needles). Where it has been identified that sharps are present and require appropriate disposal, Contractor shall provide specific containers for safe disposal of sharps.

Ensure the following for safe sharps handling and disposal:

- Used needles shall be safely disposed of in a sharps container.
- Used needles shall not be recapped.
- Sharps containers shall have BIOHAZARD warning signs and labels posted on them. Warning signs shall be fluorescent orange, with lettering and symbols of a contrasting color.
- Sharps containers shall have a clearly defined maximum capacity (i.e., have a fill line that indicates when the container is $\frac{3}{4}$ full) and shall be sturdy enough to resist punctures under normal conditions of use and handling.
- Sharps containers shall be disposed when they become $\frac{3}{4}$ full and disposed of in a proper manner (see Disposal).

Contractor shall ensure that hand washing facilities are readily accessible to workers who may be potentially exposed while providing first aid or medical assistance. If washing facilities are not provided, antiseptic cleansers shall be provided.

3.2 DECONTAMINATION

Examine any equipment and surfaces that may be contaminated (e.g., machines or where a worker has been injured). The preferred method of cleaning is having the worker use an appropriate disinfectant to decontaminate their own blood or OPIM, if they have the ability to do so.

If this option is not feasible, decontaminate any equipment that is found to be contaminated by wiping down or washing using an appropriate disinfectant. Workers completing this task must be trained and wear appropriate PPE.

Contaminated equipment and surfaces must be cleaned with a product registered with the Environmental Protection Agency (EPA) and cleared by the Food and Drug Administration (FDA) or with a mixture of bleach and water. Bleach and water should be mixed to a solution of 1 part bleach per 10 parts water or approximately 1 $\frac{1}{2}$ cups per gallon. The solution needs to be mixed

fresh and is only effective for 24 hrs. The surfaces should be sprayed, wiped and allowed to air dry. It may be necessary to send some equipment out for cleaning (e.g., clothing, etc.).

3.3 DISPOSAL

Contaminated trash (e.g., paper towels or rags) with small amounts of blood or OPIM can be placed in the regular trash containers, provided that the blood or body fluid will not be released from the media if the item is compressed.

If an item is saturated with blood or OPIM, it is not allowed in the regular waste stream. Special arrangements are needed to dispose of this trash (including disposing of sharps container bins). If an EMS service (e.g., ambulance or fire department) is providing medical attention to a worker, see if arrangements can be made to send the biohazard waste from the incident with the service provider.

Containers used for disposing of regulated waste must be:

- Closable,
- Constructed to contain all contents and prevent fluid leakage, and
- Red in color or labeled with a biohazard warning label.

Close both primary containers and secondary containers before handling, shipping or storing.

In the event that a disposal company cannot be found, small amounts of contaminated trash can be decontaminated using the following procedure then disposed of in regular trash containers:

1. Mix 1 part bleach per 10 parts water (approximately 1 ½ cups per gallon).
2. Add contaminated waste to mixture, fully soaking and covering waste.
 - Allow waste to soak a minimum of 12 hours.
3. After 12 hours, pour bleach solution down drain.
4. Rinse waste with water.
5. Allow waste to air-dry.
6. Dispose of decontaminated waste in regular trash containers.
 - Double-bagging and/or labeling is not necessary after proper decontamination

4.0 TRAINING REQUIREMENTS

Worker's who have been determined to have an occupational exposure risk are required to successfully complete Bloodborne Pathogen training.

Training for Bloodborne Pathogen Control must include:

- A general explanation of the epidemiology and symptoms of bloodborne pathogens including HBV and HIV,
- An explanation of the modes of transmission,
- An explanation of the use and limitations of control methods which include universal precautions and PPE,
- An explanation of the basis for selection of PPE, its use, limitations, location, removal, decontamination and disposal,
- Information on the HBV vaccine, including its effectiveness, its safety, the benefits of being vaccinated, method of administration, and that it is offered free of charge,
- An explanation of the procedure for exposure incidents, including reporting and post-exposure medical follow-up,
- An explanation of the sign, labels, tags and/or color-coding used to identify biohazards, and
- An opportunity for interactive discussion on the subject matter.

Course participants must also have access to a copy of the Bloodborne Pathogens Regulation, OSHA 29 CFR 1910.1030 (US workers only).

Training records for the Bloodborne Pathogens Control Specification shall include the date of the training session; a summary of the training provided; the names and qualifications of persons conducting the training; and the names and job titles of all persons attending the training sessions.

5.0 REFERENCES

Occupational Safety and Health Administration (OSHA)

Bloodborne Pathogen Regulation, 29 CFR 1910.1030

Employee Exposure and Medical Records, 29 CFR 1910.20

Canada Labour Code, Part II:

Canadian Occupational Safety & Health (COSH) regulations

National Fire Code, Part 5 (referenced by Canada Labour Code, Part II)

Transportation of Dangerous Goods (TDG) regulations

Workplace Hazardous Materials Information System (WHMIS) regulations

<END OF DOCUMENT>



Contractor Safety Specification

Confined Space - Canada

Table of Contents

1.0	Definitions & Acronyms	3
2.0	Contractor Responsibilities	6
3.0	Specification Requirements	9
3.1	Contractor Hazard Assessment	10
3.2	Control of Hazards	12
3.3	Types and Classifications of Confined Spaces	12
3.3.1	Low Hazard / Atmosphere (Restricted Space)	13
3.3.2	Moderate Hazard (Non-IDLH) Atmosphere	14
3.3.3	High Hazard (IDLH) Atmosphere	14
3.3.4	Temporary Reclassified Space	15
3.3.5	Confined Space Requirements	15
3.4	Trenches and Excavations	16
3.5	Confined Space Entry Plan	16
3.6	Pre Entry Meeting	16
3.7	Confined Space Entry Permit	18
3.7.1	Confined Space Permit Roles	19
3.7.2	Terminating an Entry	19
3.7.3	Permit Document Copies	20
3.8	Work Practices	21
3.8.1	Preventing Unauthorized Entry	21
3.8.2	Atmospheric Testing/Monitoring	21
3.8.3	Inerting	23
3.8.4	Ventilation Requirements	23
3.8.5	Hot Work	25
3.8.6	Isolation Requirements	25
3.8.7	Top-Entry Confined Spaces	26
3.9	Confined Space Rescue	26
3.9.1	Rescue Plan	27
3.9.2	Rescue Equipment	28
3.10	Confined Space Closure Requirements	28

3.11	Confined Space Package.....	28
4.0	References.....	29
5.0	Appendix.....	30
5.1	Identification of a Confined Space	30
5.2	Confined Space Entry Permit.....	31

1.0 DEFINITIONS & ACRONYMS

Acceptable Entry Conditions - the conditions that must exist in a confined space to allow entry and to ensure that workers involved with a confined space entry can safely enter and exit into and work within the space. Prior to an entry, all access points for entry and exit will need to be determined.

Blanking – isolation method for the absolute closure of piping that involves inserting a physical barrier through the cross-section of pipe so material is prevented from flowing past that point. Blanks shall be of sufficient rating to withstand the highest possible pressure that may result.

Blinding – isolation method for the absolute closure of piping that involves disconnecting a pipe and attaching a physical barrier to the end so material is prevented from flowing out of the pipe. Blind flanges used for this purpose shall be of sufficient rating to withstand the highest possible pressure that may result.

Confined space - an enclosed or partially enclosed space that

- (a) Is not designed or intended for continuous human occupancy except for the purpose of performing work,
- (b) Has restricted means of access and egress, and
- (c) May become hazardous to any person entering it owing to
 - (i) Its design, construction, location or atmosphere,
 - (ii) The materials or substances in it, or
 - (iii) Any other conditions relating to it

Confined Space Attendant -a qualified worker who is stationed outside one or more confined spaces who monitors the authorized entrants and who performs all attendants' duties assigned in the employer's confined space program.

Confined Space Authorized Entrant - a qualified worker who is authorized by the employer to enter a confined space.

Confined Space Entry Coordinator– is a Company representative from the work group who is hiring a contractor to perform confined space entry. The coordinator may or may not be onsite at the time of entry. The purpose of this role is to communicate and coordinate as required, the transfer of available information on the confined space, planning, isolation, hazard assessments, etc. with contractors, operations and projects.

Emergency - any occurrence (including any failure of hazard control or monitoring equipment) or event internal or external to the confined space that could endanger authorized entrants.

Enbridge - Enbridge, Inc. and Enbridge (U.S.) Inc., hereinafter will be referred to as “Company”

Engulfment - the surrounding and effective capture of a person by a liquid or finely divided (flow able) solid substance that can be aspirated to cause death by filling or plugging the respiratory

system or that can exert enough force on the body to cause death by strangulation, constriction, or crushing.

Entry - the action by which a qualified worker passes through an opening into a confined space. Entry includes ensuing work activities in that space and is considered to have occurred as soon as any part of the authorized entrant's body breaks the plane of an opening into the space.

Entry Permit - document that allows and controls entry into a confined space.

Entry Supervisor – is the qualified worker who is responsible for confined space entry and determining if acceptable entry conditions are present at a confined space where entry is planned, and overseeing entry operations, and for terminating entry as required.

Flammable Atmosphere - any atmosphere that contains 10% or more of the Lower Explosive Limit (LEL), or Lower Flammable Limit (LFL) for any substance.

Hazardous Atmosphere - An atmosphere which exposes an individual to a risk of injury, illness, disablement, or death due to one or more of the following causes:

- A flammable gas/vapor concentration in excess of 10% of its lower explosive limit (LEL)
- An atmospheric oxygen concentration below 19.5% or above 23%.
- An atmospheric concentration of any substance above the exposure limits established by the governing regulatory body or as indicated on the Safety Data Sheet (SDS)
- Airborne combustible dust at a concentration that meets or exceeds its LFL;
Note: This concentration may be approximated as a condition in which the dust obscures vision at a distance of 5 feet (1.52 m) or less.
- High Hazard (IDLH) Atmosphere – an atmosphere that may expose a worker to risk of death, incapacitation, injury, acute illness or otherwise impair the ability of the worker to escape unaided from a confined space, in the event of a failure of the ventilation system or respirator

Hot Work - Any process that can be a source of ignition when flammable material is present or can be a fire hazard regardless of the presence of flammable material.

Immediately Dangerous to Life and Health (IDLH) Atmosphere - An atmospheric concentration of any toxic, corrosive or asphyxiant substance that poses an immediate threat to life or would cause irreversible or delayed adverse health effects or would interfere with an individual's ability to escape from a dangerous/hazardous atmosphere.

Inerting - the displacement of the atmosphere in a confined space by a non-combustible gas (such as nitrogen) to such an extent that the resulting atmosphere is non-combustible.

Note: This procedure produces an IDLH oxygen-deficient atmosphere.

Isolated - Sources of energy have been disconnected or controlled.

Isolation - the process by which a confined space is removed from service and completely protected against the release of energy and material into the space by such means as: blanking or blinding; misaligning or removing sections of lines, pipes, or ducts; a double block and bleed

system; lockout or tagout of all sources of energy; or blocking or disconnecting all mechanical linkages.

LOTO – lockout tagout

Low Hazard Atmosphere - an atmosphere which is shown by pre-entry testing or otherwise known to contain clean respirable air immediately prior to entry to a confined space and which is not likely to change during the work activity, as determined by a qualified worker after consideration of the design, construction and use of the confined space, the work activities to be performed, and all engineering controls.

Lower Explosive Limit (LEL) - The lowest concentration (percentage) of a gas or a vapor in air capable of producing a flash of fire in presence of an ignition source (arc, flame, heat). At a concentration in air below the LEL there is not enough fuel to continue an explosion. Concentrations lower than the LEL are "too lean" to explode but may still burn with great heat and light. Exact values can be found on product's SDS.

LFL – Lower Flammable Limit

Moderate Hazard (Non-IDLH) Atmosphere –an atmosphere that is not clean respirable air but is not likely to impair the ability of the worker to escape unaided from a confined space, in the event of a failure of the ventilation system or respirator.

NORMs – Naturally Occurring Radioactive Material

Oxygen Deficient Atmosphere - an atmosphere containing less than 19.5% oxygen by volume.

Oxygen Enriched Atmosphere - an atmosphere containing more than 23% oxygen by volume.

PPE – Personal Protective Equipment

Prohibited Condition - any condition in a confined space that is not allowed by the permit during the period when entry is authorized.

Qualified— a worker who, by possession of a recognized degree, certificate, or professional standing, or who by knowledge, training and experience, has successfully demonstrated their ability to solve or resolve problems relating to the subject matter, the work, or the project.

Rescue Team- the qualified personnel designated to rescue workers from confined spaces.

Retrieval system - the equipment (including a retrieval line, chest or full-body harness, wristlets or anklets, if appropriate, and a lifting device or anchor) used for non-entry rescue of persons from confined spaces.

SABA – Supplied Air Breathing Apparatus

SCBA – Self-Contained Breathing Apparatus

SWP – Safe Work Permit

Toxic Atmosphere –an atmospheric concentration of any substance above the exposure limits established by the governing regulatory body or as indicated on the Safety Data Sheet (SDS).

2.0 CONTRACTOR RESPONSIBILITIES

Contractor Management shall:

- Ensure compliance with all Applicable Legislation and Company requirements including, but not limited to:
- Ensuring work is conducted in accordance with this Specification, Confined Space Entry Permit, Entry Plan and Hazard Assessments, and any procedures established as a result of this Specification
- Ensuring an Entry Supervisor is assigned for each confined space entry
- Ensuring all Workers involved in Confined Space work are qualified and have completed applicable Confined Space training
- Ensuring Confined Space rescue plans are developed prior to an entry
- Ensuring all required documentation applicable to Confined Space entry is developed, completed and maintained, in accordance with Company requirements and applicable Legislation
- Ensuring all resources (e.g., personnel, equipment, personal protective equipment (PPE)) required for each Confined Space Entry are readily available
- Ensure all workers who are on a site where there an actual or potential confined space exists, is trained in the recognition and identification of a confined space.
- Ensure that workers are informed of the hazards and controls associated with confined space entries.
- Coordinate all confined space entries with Operations for sites Operations has ownership of
- Coordinate contractor confined space entries on their sites with the work group who is performing the work
- Ensure compliance with the signage requirements for confined spaces
- Follow all procedures and specifications when performing a confined space entry
- Maintain communications with the contractor throughout the planning, execution and completion of confined space activities.
- Debrief the contractor at the conclusion of the entry operations regarding the permit space program followed and regarding any hazards confronted or created in permit spaces during entry operations.

Confined Space Attendant at a minimum shall:

- Attend and participate in the confined space Pre Entry Meeting

- Review the entry and rescue procedures, being aware of all confined space entry permit and hazard assessment requirements and ensuring all requirements are followed
- Be aware of the hazards of the confined space being entered
- Be aware of the signs and symptoms of exposures and the possible behavioral effects or other effects of exposure
- Ensure they have an effective means of constant communication with the workers entering the confined space, the emergency rescue personnel and the Entry Supervisor at all times
- Ensure initial and ongoing air testing occurs, as required, and the test results are recorded on the confined space entry permit
- Ensure entry points are kept clean and clear
- Control access to the confined space and prohibit entry to unauthorized workers
- Track and record on the confined space entry permit, all personnel entering and exiting a confined space, and control the number of authorized entrants within the space as required by the confined space entry permit
- Be aware of hazardous, prohibited or unacceptable conditions that require evacuation of the space
- Maintain communication with the permit receiver and notify them immediately if unacceptable conditions have developed.
- Be prepared to initiate evacuation from the space, as necessary, due to actual or potential hazards (this could include hazards within the space and also in the vicinity of the space that could affect the health and safety of workers)
- Ensure the space has been completely evacuated in the event of an emergency
- Request rescue and other emergency services when necessary, e.g., as soon as it is determined that workers in a confined space may need assistance to evacuate; or, if a situation arises outside the confined space that could endanger the workers inside or near the confined space
- Not enter a confined space for any reason and never leave the entrance to a confined space, unless relieved by another designated and qualified attendant
- Not enter the space to perform rescue operations, if qualified for rescue work in accordance with the rescue procedure for that confined space, unless they have been relieved by another attendant
- Not perform other duties which might interfere with their primary duty to monitor and protect the authorized entrants working in the space, unless they are performing non- entry rescue in accordance with the rescue procedure

- Verify that no person is inside the confined space before it is closed off, and ensure proper signage/barricades are in place to prevent unauthorized entry into the confined space prior to leaving the entrance of a confined space

Entry Supervisor at a minimum shall:

- Ensure all confined space entry and regulatory requirements are met prior to the confined space entry permit being issued.
- Verify compliance with the requirements on the Confined Space Entry Permit
- Ensure all workers are qualified to perform their assigned tasks and roles
- Know the hazards that may be faced during entry work, including information on the potential modes of exposure, plus the signs, symptoms and consequences of different exposures
- Ensure a hazard assessment is completed prior to entry and review the hazard assessment with the workers
- Conduct the confined space Pre Entry Meeting
- Conduct and oversee the work in accordance with the Pre Entry Meeting
- Ensure workers follow the requirements set out during the Pre Entry Meeting
- Ensure adequate steps have been taken to eliminate and/or control all present or potential hazards
- Verify hazard controls are implemented and effective
- Ensure all required atmospheric monitoring and testing has been completed as required by the hazard assessment and confined space plan and is properly documented
- Ensure that rescue personnel, plans, and equipment are in place if applicable
- Ensure there is a suitable means of communication among workers
- Ensure that acceptable conditions are maintained for the duration of the entry work and that any requirements or status changes are communicated to the next entry supervisor if applicable
- Terminate the confined space entry and permit if conditions warrant termination

Note: this role can be a company employee or a contractor who is involved with the entry, but are not an entrant performing work. However, a contractor Entry Supervisor cannot be the approver on the Confined Space Permit. The approver will be either operations or projects.

Authorized Entrant at a minimum shall:

- Attend and participate in the confined space Pre Entry Meeting entry meeting
- Review the entry and rescue procedures, being aware of all confined space entry permit and hazard assessment requirements and ensuring all requirements are followed

- Be aware of the hazards of the confined space being entered
- Immediately notify the Entry Supervisor when they do not feel qualified to perform a task or assigned duty
- Conduct work as directed by the Entry Supervisor, and in accordance with company requirements
- Alert the Entry Supervisor when a hazard has not been adequately controlled
- Be aware of the signs and symptoms of exposures and the possible behavioral or other effects
- Maintain communication with the attendant and immediately notify the attendant if an emergency or a hazardous, prohibited or unacceptable condition requires evacuation of the confined space

- Exit the space as quickly as possible when any of the following occurs:
 - An emergency
 - The attendant gives the order to evacuate the space
 - A hazardous, prohibited or unacceptable condition is detected
 - An evacuation alarm is activated
- Properly use equipment
- Wear/use the required equipment (e.g., PPE, respiratory protection equipment, rescue equipment) properly, in a safe manner and at all times
- Know the limitations of equipment used to control hazards related to confined space entry work
- Sign in and sign out of the confined space with the attendant

Rescue Personnel at a minimum shall:

- Ensure all retrieval equipment is in good working order
- Ensure that the proper rescue equipment is readily available and in close proximity to the confined space.
- Writes or is involved in the writing and review of the confined space rescue plan
- Review the confined space and understands the hazards and controls
- Participates in the Pre-Entry Meeting Entry Meeting at a minimum when work is being conducted in a High Hazard Atmosphere- IDLH Atmosphere Confined Space

3.0 SPECIFICATION REQUIREMENTS

3.1 CONTRACTOR HAZARD ASSESSMENT

A Field Level Hazard Assessment (FLHA) is required before entering a confined space.

When completing a confined space hazard assessment, the qualified worker is responsible for identifying and assessing existing and potential hazards specific to the work activity and related job tasks that may exist due to the design, construction, location, use or contents of the confined space that may develop while work is done inside the confined space.

If two or more confined spaces are of similar construction and present the same hazards, their confined space hazard assessments may be recorded in a single document, but each confined spaces shall be clearly identified in the assessment.

The confined space hazard assessment must also consider specified risks including:

- the conditions which may exist prior to entry due to the confined space's design, location or use, or which may develop during work activity inside the space, and
- the potential for oxygen enrichment and deficiency, flammable gas, vapour or mist, combustible dust, other hazardous atmospheres, harmful substances requiring lockout and isolation, engulfment and entrapment, physical and configuration hazards, emergency response limitations, and other hazardous conditions.

Factors to be considered in the confined space hazard assessment include:

- Hazardous atmospheres either as a normal characteristic of the space or as the product of the required work processes to be conducted in the space:
 - Oxygen Deficiency or Enrichment: Oxygen deficiency may be caused by consumption by workers, oxidation (rusting) process, burning, welding, or bacteria, or by the absorption by chemicals or products. An oxygen deficient atmosphere is one that contains less than 19.5% oxygen. Oxygen enrichment may be caused by leaking of oxygen into the space or generation by chemical processes. An oxygen enriched atmosphere is one that contains more than 23% oxygen.
 - Asphyxiates: Inert gases can dilute or displace oxygen below a safe level (e.g., methane, carbon monoxide, carbon dioxide, nitrogen) during purging or by leaking into the confined space due to improper isolation and lockout.
 - Toxicity: Gases (H₂S, Methane, CO, etc.), vapours, dusts, or fumes that have a poisonous effect from operations such as cleaning, painting, coating, etc., or from gases like methane or H₂S leaking into the confined space. Carbon monoxide may be generated by internal combustion engines within the confined space or running near air intakes for the ventilator in use. A toxic atmosphere is an atmospheric concentration of any substance above the exposure limits established by the governing regulatory body or as indicated on the Safety Data Sheet (SDS).
 - Flammable or Explosive Atmospheres: Flammable gases (methane, ethane, etc.), vapours, dust that could be ignited by an uncontrolled ignition source. This risk increases if an oxygen-enriched atmosphere (23% by volume) is present.
 - Vapours, Mists, or Dusts.

- Harmful energy sources requiring isolation and lockout to ensure they remain in a zero-energy state.
- Uncontrolled introduction of water, liquids, steam, or gases (improper control of water, steam, or pressurized gases introduced during cleaning or surface preparation work).
- Contact with moving parts (being trapped or crushed by moving parts not properly isolated/locked out).
- Crushing/Engulfment or entrapment (risk of becoming trapped or buried by internal components or bulk materials).
- Entry and exit to the confined space sufficient for emergency egress and size adequate to allow personnel wearing respiratory equipment, if required by conditions.
- Other hazards resulting from work or equipment being used, such as:
 - Electrical hazards (including static),
 - Excessive temperatures - heat or cold,
 - Noise,
 - Falls/slips,
 - Radiation,
 - Direct contact with corrosives,
 - Iron sulphide (pyrophoric material), or
 - Biological substances (e.g., bird or rodent droppings) or stinging/biting insects and snakes.
- Tools required to be used in the work.

If a hazardous condition develops in a space during the entry, the work activity will be suspended and the confined space hazard assessment will need to be reviewed and updated as applicable before work resumes in the confined space.

The confined space hazard assessment review shall evaluate the effectiveness of hazard assessment process regarding the confined space and the suitability of established controls. The review of controls shall be based on relevant factors, such as:

- changes in workplace conditions or work activities
- workplace inspection reports
- injury statistics
- incident investigations
- the applicable Safety Data Sheet (SDS) of any hazardous products that were contained in the Confined Space or that could be released.

3.2 CONTROL OF HAZARDS

Risks associated with a confined space may be reduced by:

- Elimination:
 - Eliminate the confined space by eliminating the need to enter the space
 - Eliminate the confined space by modifying the configuration of the space.
- Substitution:
 - Utilizing tools in lieu of a traditional entry
 - Confined space work is contracted to a qualified contractor to perform
- Engineering Controls:
 - Ventilation to maintain the oxygen level between 19.5% and 23%
 - Ventilation to ensure clean breathable air is continuously blown into the space
 - Isolation to remove or separate equipment from all energy sources and appropriate control the energy through lockout
 - Eliminate the confined space by modifying the configuration of the space
 - Providing pedestrian, vehicle, or other barriers as necessary to protect entrants from external hazards
- Administrative Controls
 - Procedures for continuous atmospheric monitoring
 - Permits and planning for confined space entry and rescue
 - Procedures and guidelines for confined space entry
- Personal Protective Equipment (PPE)
 - Personnel may be required to wear an appropriate level of respiratory protection, full body harness, lifeline, and other PPE as necessary that is identified in the hazard assessment and as per company policy. A harness and lifeline should be worn to facilitate non-entry rescue at all times unless the retrieval equipment would increase the overall risk of entry or would not contribute to the rescue of the entrant. Guidance on proper selection of PPE is covered in Personal Protective Equipment, Fall Protection Specification and Respiratory Protection Specification.

3.3 TYPES AND CLASSIFICATIONS OF CONFINED SPACES

Confined spaces are at most locations. Spaces that typically meet the definition of confined spaces on the company's property include, but are not limited to:

- Tanks
- Vaults
- Culverts
- Pressure vessels

- Pits
- Some parts of machinery
- Ventilation systems
- Access openings (manholes)
- Pipes
- Towers (heaters)
- Railway tank cars

All Confined Spaces shall be designated as High Hazard Atmosphere – IDLH Atmosphere until results of initial Atmospheric Monitoring are determined. Based on the results, a space may then be newly designated as Low Hazard / Restricted Space, – Moderate Hazard Atmosphere – Non-IDLH, or High Hazard Atmosphere – IDLH Atmosphere.

When determining if a space is a confined space, see Appendix 6.1 Identification of a Confined Space for additional guidance.

3.3.1 LOW HAZARD / ATMOSPHERE (RESTRICTED SPACE)

A low-hazard / atmosphere (restricted space) - low-hazard atmosphere is one where a hazardous atmosphere is not likely to exist. A low-hazard / atmosphere (restricted space) is where the actual and potential for the following to exist is unlikely while workers are in the confined space for the duration of the work activity:

The development of a hazardous gas, vapour, dust or fumes in normal conditions or

Unsafe oxygen content less than 19.5% or more than 23% by volume.

Typically the risks are more associated with the physical configuration of the space, access/egress, etc. Under normal conditions, it is anticipated that this atmosphere is not likely to change during the work activity.

Note: if ventilation is required to maintain a low hazard atmosphere, the space is considered Moderate Hazard (Non-IDLH) Atmosphere at a minimum

The basis for determining that all Hazards in the space have been eliminated is documented on:

- Parts 1 -6 of the Confined Space Entry Permit; and
- Hazard Assessment

If a Hazard arises or occurs within a low-hazard / atmosphere (restricted space), each worker in the space shall exit the space. The space shall then be reassessed to determine if it shall be re-designated as a Moderate Hazard (Non-IDLH) Atmosphere or High Hazard (IDLH) atmosphere Confined Space.

3.3.2 MODERATE HAZARD (NON-IDLH) ATMOSPHERE

A moderate-hazard (Non-IDLH) atmosphere is one where there is the potential for a hazardous atmosphere to exist i.e., a Confined Space which has been purged and ventilated and steps have been taken to provide and maintain a safe atmosphere and there has existed or was likely to have existed:

- A hazardous gas, vapour, dust or fumes; or
- Unsafe oxygen content less than 19.5% or more than 23% by volume could develop if circumstances change.

These types of spaces have been known to have potentially hazardous atmospheres either before or during the work. An example could be a vessel containing a product. After isolation, cleaning, purging, ventilation, the fact it had something hazardous in there to begin with leads to a potential that an atmosphere could exist if something were done incorrectly or if other equipment fails (ex: ventilation fan). Hence, a Moderate-Hazard (Non-IDLH) Atmosphere confined space.

If an IDLH atmosphere is encountered during a Moderate Hazard (Non-IDLH) atmosphere entry; workers must vacate the space and additional controls should be implemented to mitigate the hazard and lower the levels below IDLH. If this cannot be achieved, then the Company Director's (or designate's) approval is required to proceed with a High Hazard Atmosphere entry.

3.3.3 HIGH HAZARD (IDLH) ATMOSPHERE

A high hazard (IDLH) atmosphere is one where a hazardous atmosphere does exist i.e., a Confined Space which cannot be ventilated to provide and maintain a safe atmosphere, and in which there now exists or is likely to exist:

- A hazardous gas, vapour, dust or fumes; or
- An oxygen content of less than 19.5% or more than 23%.

This is a type of space that, due to the unique circumstances of the particular space, the atmosphere cannot be purged and/or ventilated adequately to provide a safe breathable atmosphere. It could also be a situation where the atmosphere may be completely unknown or the space be compromised by the ambient working environment. Therefore, it is considered to be a High-Hazard Atmosphere confined space.

Planned work should not take place in IDLH environments. If an IDLH environment exists, or has potential to exist, then work shall stop until controls are in place to eliminate, control or minimize the hazards to an acceptable level. Entry into a confined space that has been classified as a high hazard (IDLH) atmosphere – IDLH requires Company Director (or designate) approval of confined space entry plan, procedures and Hazard Assessment, refer to the Immediately Dangerous to Life and Health Atmospheres procedure for process for working in an IDLH atmosphere.

3.3.4 TEMPORARY RECLASSIFIED SPACE

A temporary reclassified confined space is one that started as a confined space, but through control of all actual or potential hazards no longer meets the definition of a confined space (e.g., no longer has limited means for entry and exit, etc.). An example of this would include a tank that has been degassed, cleaned, and has a door sheet removed. In this situation, the workers will still need to consider all applicable safety specifications, e.g., atmospheric monitoring, PPE, Respiratory Protection, etc.

3.3.5 CONFINED SPACE REQUIREMENTS

	Low Hazard Atmosphere (Restricted Space)	Moderate Hazard (Non-IDLH) atmosphere	High Hazard (IDLH) atmosphere	Temporary Reclassified space
Is a confined space permit required?	Required – Parts 1 – 6	Required – All Parts		The space no longer meets the criteria of a confined space and must be in compliance with the requirements of the Safe Work Permit
Safe Work Permit	Per the requirements of the Safe Work Permit & Work Authorization Specification			
Hazard Assessment	Required			
Confined Space Entry Plan / Package	Required			
Air Monitoring	Initially to establish clean respirable air atmosphere – As Required in Atmospheric Specification	Required		
Isolation & LOTO	Determined by the hazard assessment			
PPE	As required in the PPE, Respiratory Protection Specification			
Pre Entry Meeting	Required			
Director (or Designate) Approval	Not Required		Required	
Rescue Team Requirements	Determined by hazard assessment	Onsite and prepared to respond	Outside the confined space and available to provide immediate response	
Rescue Plan	Yes			
Location and Attention of Confined Space Attendant	Must be able to fulfill duties below	Must be stationed near space entrance	Must be stationed near space entrance and exclusively and continuously attend to Confined Space Attendant duties	
Rescue requirements for Confined Space Attendant	Able to immediately summon rescue personnel	Able to immediately summon rescue personnel	Equipped and capable of performing rescue / fulfilling rescue duties	
Confined Space Attendant check on wellbeing of Worker(s)	Every 20 minutes	Minimum of every 20 minutes; more often based on hazards of space or task performed	Continuous	
Additional Duties of Confined Space	N/A	N/A	Prevent entanglement of lifelines and airlines	

Attendant				
Entrant contact with Confined Space Attendant	A way for Entrant to summon Confined Space Attendant at any time	A way for Entrant to summon Confined Space Attendant at any time, including from inside the space	A way for Entrant to summon Confined Space Attendant at any time, including from inside the space	

3.4 TRENCHES AND EXCAVATIONS

A trench or excavation is not considered a confined space unless otherwise determined through hazard assessment due to:

- Impeded access/egress as a result of the depth of excavation or complexity of piping within the excavation, and
- Contains or has the potential to contain a hazardous atmosphere.
- These exceptions need to be determined in advance and discussed during work planning.

Although the excavation itself may not be a confined space, a confined space may exist within an excavation, e.g. entry into a pipe. The hazard assessment will need to include any activity that has the potential to produce a hazardous atmosphere.

3.5 CONFINED SPACE ENTRY PLAN

Before a worker is permitted to enter a confined space, the work group that is responsible for or conducts confined space operations must prepare and implement a written confined space entry plan which includes at a minimum:

- Information on the confined space (e.g., dimensions, hazards, controls, ventilation)
- Identification of work activity
- Verification of lockout and isolation if applicable
- Ventilation calculations if applicable
- Communication process (e.g., constant communication with authorized entrants, emergency warning system)
- Identify roles and responsibilities
- Required PPE, including the use of lifelines
- Rescue equipment
- Lockout and isolation, coordination of work activities.

3.6 PRE ENTRY MEETING

The Entry Supervisor will conduct a Pre Entry Meeting entry meeting prior to entry with all involved workers including:

- Worker(s) entering space
- Confined space attendant personnel
- Rescue personnel, at a minimum when working in a High Hazard (IDLH) atmosphere Confined Space
- Site or Worker Supervisor(s) that may direct the work of any of the above

The Pre Entry Meeting will cover the following before confined space entry as applicable:

- The confined space entry permit requirements
- Established procedures
- Air testing procedures
- Method of recording testing results
- Communication system
- Isolation of energy sources and control of materials movement
- Required PPE/respiratory protection equipment
- Securing the confined space from unauthorized entry
- Emergency equipment and required inspection of the equipment
- Ventilation requirements

In the event personnel are added to the Entry Team that did not attend the pre-entry meeting, the Entry Supervisor must review the contents of the meeting with the additional personnel and be satisfied they are fully briefed on their role and responsibilities in the entry activities.

The Entry Team should engage in cursory review of the contents of the Confined Space Package, with a primary focus on:

- Ensuring the stipulations set out in the Confined Space Hazard Assessment have been or will be met prior to entry, including
 - Pre-initial entry preparations such as isolation, lock out / tag out, and any cleaning, purging, or ventilation activities.
 - Controls to be applied during entry or work within the space.
- Ensuring familiarity with the procedure for initial and any subsequent entry under review.
- Review of the Rescue Plan and ensuring all members are clear on their roles.

All stipulated pre-entry preparation activities must be complete and verified prior to entry.

For subsequent entries to conduct tasks within confined spaces, the size, scope, and necessity of an Entry Team meeting needs to be based on:

- The level of hazards within the space and introduced by the tasks to be conducted.

- The existing familiarity of entrants, confined space attendant, rescue, Entry Supervisor with the confined space and its hazards (e.g., are the same personnel involved as those attending the pre entry meeting?).
- At minimum, prior to any entry to complete a task, the Entry Supervisor must go over the Confined Space Hazard Assessment for the task at hand with the Entrants as part of the Safe Work Permit process (in lieu of a full Entry Team meeting).

3.7 CONFINED SPACE ENTRY PERMIT

A worker shall not enter a confined space without a valid confined space entry permit. Any site emergency, or if the criteria for entry to be terminated is met, shall force the stoppage of all work and will require a new permit to be authorized. The following requirements apply to the confined space entry permit:

- The permit is issued and authorized by permit issuer
- The permit is received by a qualified worker who is involved in the confined space entry
- The permit is approved by a qualified Company representative when a contractor is performing entry
- The permit must be signed by the permit issuer, receiver and approver if applicable
- The permit cannot be issued until all required fields are completed, and all hazards have been identified and controlled
- If there are changes in the field, the permit will be revised and discussed with impacted workers. If there is a change to the scope of work, a new permit is required.
- Permits are valid for 12 hours or until the end of the shift, unless there is an approved extension. A permit may be extended if:
 - authorized entrants involved in the work remain the same
 - The extension is identified and authorized on the permit by the permit issuer
 - When an extension is required, both copies of the permit need to be authorized by the permit issuer
 - A review of the permit confirms it is still valid
- The permit must identify conditions to terminate entry.

The permit will be maintained / posted outside of the confined space with the supporting documents.

A single permit may be utilized for multiple spaces when the hazards of the space and the work to be performed are similar.

In the event that an entry has been terminated, this includes the permit being terminated, until the hazard assessment can be updated, and the space is deemed safe for entry.

3.7.1 CONFINED SPACE PERMIT ROLES

Confined Space Permit Issuer shall:

- Determine Confined Space Classification
- Review Hazards and controls with the Permit Receiver
- Verify that appropriate controls are in place
- Ensure Initial Atmospheric Monitoring is complete
- Ensure all confined space entry and regulatory requirements are met prior to issuing the confined space entry permit
- Terminate the confined space entry and permit if conditions warrant termination

Note: this role can be filled by a Company Representative

Confined Space Entry Permit Approver shall:

- Acknowledging the work
- Review Hazards and controls with the Permit Issuer
- Ensure the Confined Space Entry Permit Issuer is aware of site-specific information

Note: this role is intended for approval of contractor entries. This role can only be filled by a qualified Company Representative.

Confined Space Entry Permit Receiver shall:

- Attend and participate in the confined space Pre Entry Meeting entry meeting
- Review Hazards and controls with the Permit Issuer
- Provide the Permit Issuer with adequate notice of intended entry to review scope, hazards and confined space documentation.
- Provide a sufficient description of the scope of work
- Review hazards and controls with Workers involved in the work
- Ensure requirements on the permit are followed

Note: this role can be either a Company Worker or contractor who is involved with the entry to be performed.

3.7.2 TERMINATING AN ENTRY

If atmospheric monitoring indicates that unplanned or unexplained changes have occurred in the confined space, all work shall stop and workers will evacuate the confined space. The hazard assessment and permit shall be reviewed if an entry has been terminated and updated as required.

The Entry Supervisor will document on the confined space permit atmospheric conditions of when a confined space entry will be terminated.

If the acceptable criteria cannot be maintained, the typical conditions to terminate an entry may include:

- Oxygen levels that are below 19.5%, or above 23%
- LEL of greater than 10% when conducting hot work
- LEL of greater than 20%
- When any contaminant is above the action level per legislative requirements
- Any injury
- Any abnormal operation
- Change to the scope of work
- Site emergency
- If requested to stop work

The time of termination shall be documented on the Confined Space Permit, as the case may be, by the Receiver. Suspended permits shall be revalidated, at a minimum, verbally by the Issuer and documented on the Confined Space Permit before work can resume.

Suspensions due to scope of work changes cannot be revalidated. A new Confined Space Permit is required.

3.7.3 PERMIT DOCUMENT COPIES

White/top copy: Permit Receiver keeps or posts this copy at the work location while the permit is valid. Permit Receiver returns this copy, and other pertinent documentation to the Permit Issuer when the Permit time period has expired.

If an Incident occurs during the course of work, the white copy of the Permit along with all other documentation shall be forwarded to the person responsible for conducting the incident investigation and will be retained as identified in the requirements for incident investigation documentation.

Yellow copy: Permit Issuer maintains this copy to identify work activities occurring at the site. Discard after the white copy is returned.

In compliance with Company's Records Management Policy and Records Retention Schedule, Company Representative must retain all Permits and any related documents or records. All required documentation applicable to Confined Space entry is developed, completed and maintained, in accordance with Company requirements and Applicable Legislation.

Contractors shall have a records retention policy to ensure that all documents or records used, prepared or produced by the contractor in the performance of the work are maintained by the contractor for durations of time that are not less than the limitation periods prescribed in the

applicable statutes of limitations or limitation of actions legislation in force in the jurisdictions the contractor operates.

3.8 WORK PRACTICES

3.8.1 PREVENTING UNAUTHORIZED ENTRY

All Confined Spaces in the Confined Space Inventory must either be:

- Secured against entry (e.g., bolted shut or locked), or
- Identified by a sign that states “Danger, Confined Space, Entry by Permit Only or a sign that uses similar wording at the entry point to indicate that this is a Confined Space and that entry is not permitted without a permit.
- When there is a confined space attendant present at an open confined space, the attendant must ensure all entrants are authorized for entry into the confined space.

Signage that has been removed to allow entry into the confined space shall be replaced when the space has been left unoccupied, this include breaks and shift change.

3.8.2 ATMOSPHERIC TESTING/MONITORING

Refer to the Atmospheric Monitoring and Respiratory Protection Specifications for additional information on confined space atmospheric monitoring and sampling.

Atmospheric monitoring for hazards shall:

- Be conducted by a qualified worker using calibrated test instruments that are appropriate for the atmosphere being tested and used in accordance with manufacturers’ specifications
- Be completed in accordance with the requirements identified on the hazard assessment
- Be performed in a manner that does not endanger the health or safety of the worker performing the test
- Be performed in the following order:
 1. Oxygen content (% O₂)
 2. Flammable gases/vapors (% LEL)
 3. Toxic air contaminants (e.g., H₂S)
 4. Other toxic contaminants associated with the work environment, work activity and related job tasks (e.g., CO, Benzene)

Initial Atmospheric Monitoring

Initial atmospheric monitoring is required prior to entry into any confined space, and before a worker re-enters a confined space that has been unoccupied for any length of time. Initial testing must be performed no more than 20 minutes prior to an entry. Atmospheric testing must be repeated within 20 minutes of entry if a confined space is vacated for more than 20 minutes.

Initial monitoring should be completed from outside the space utilizing remote gas detector accessories and equipment such as sample draw pumps and wands whenever possible. Initial atmospheric testing from outside the confined space is not considered entry and does not require a permit. If testing is being completed by a contractor, a safe work permit would be required prior to the completion of the task.

If initial atmospheric monitoring cannot be completed from outside the confined space, conduct initial testing under the respiratory protection level based on the conditions at the time. If this cannot be determined or adequately assessed, wear SCBA / SABA respiratory protection.

If the levels at the entrance are not IDLH, then entrants can proceed further into the space under air, without Company Director (or designate) approval until an IDLH atmosphere is encountered. If an IDLH atmosphere is encountered during initial monitoring, the entrants must vacate the space and treat as a High Hazard (IDLH) atmosphere, requiring Company Director's (or designate's) approval for entry".

The Company treats all spaces as High Hazard (IDLH) atmospheres prior to initial entry; however, Company Director (or designate) approval is not required to perform initial atmospheric monitoring of the space until a hazardous (IDLH) atmosphere is confirmed.

Complete atmospheric monitoring at various locations and elevations of the space whenever possible. Refer to the Atmospheric Testing Specification and the manufacturer's recommendations when performing atmospheric monitoring. Also, consider the response times, length of hose, attachments, functionality of monitor etc.

Continuous/Periodic Monitoring

For confined spaces deemed to have a moderate or severe hazard atmosphere, continuous monitoring of gases that present an ongoing risk to entrants is required. Continuous atmospheric monitoring for the following is required anytime a worker is in a confined space:

- Oxygen (% O₂)
- Lower explosive limit (% LEL)
- Hydrogen sulfide (H₂S)
- Carbon monoxide (CO)

Levels are documented on the confined space entry permit at a frequency determined by the Entry Supervisor.

Periodic atmospheric monitoring and atmospheric sampling may be required for other hazards or contaminants (e.g. benzene). These frequencies shall be determined by the Entry Supervisor and documented on the confined space entry permit. Frequency for testing may vary from minutes to hours, depending on the hazards of the space.

The use of a Personal Monitor when working in a confined space should be in accordance to the requirements of the Atmospheric Monitoring Specification.

3.8.3 INERTING

A confined space may be inerted if it is not reasonably practicable to eliminate an explosive or flammable atmosphere through other means. Inerted confined spaces will be treated as High Hazard (IDLH) Atmosphere due to the removal of oxygen. If a confined space is inerted, ensure that:

- Every worker entering the confined space is equipped with SCBA / SABA respiratory protection equipment until oxygen levels have returned to normal.
- All ignition sources are controlled
- The atmosphere within the confined space stays inerted while workers are inside.

Note: notification to regulatory bodies may be required when placing workers in an inert atmosphere per local legislative requirements

3.8.4 VENTILATION REQUIREMENTS

If atmospheric hazards exist or are likely to exist in a confined space, the confined space shall be purged or ventilated, or both, before any worker enters the space. Acceptable atmospheric levels, as identified on the confined space entry permit, shall be maintained at all times when worker(s) are present in a confined space.

Ventilation requirements shall be determined prior to the entry of the confined space, or utilized if levels are not acceptable. If testing indicates that the confined space's atmosphere is explosive, or if assessment determines that an explosive atmosphere is likely to develop, then purging of the space with an inert gas shall be performed prior to ventilation. Using air movers as a means of ventilation may create a hazardous, explosive atmosphere, due to the addition of oxygen into the confined space.

If ventilation and/or purging are not practical to maintain acceptable atmospheric levels in a confined space, the workers involved shall wear respiratory protection equipment in accordance with the Respiratory Protection Specification.

If mechanical ventilation is required to maintain a safe atmosphere in a confined space, the ventilation equipment shall be equipped with an alarm that will be activated automatically if the equipment fails. An adequate warning system of ventilation failure shall be in place, to ensure each worker receives each warning and is able to exit the confined space safely.

The mechanical ventilation equipment shall be audible or visible to every worker in the confined space, or monitored by a worker who is in constant attendance at the equipment and who is in communication with the authorized entrants. Should the ventilation equipment fail to operate properly, this worker shall immediately direct the authorized entrants to evacuate.

Air volume for confined spaces shall meet the following criteria, if applicable:

- Minimum volume of 1.9 m³/s of air passes through the active working area; or

- Air in the confined space contains at least 19.5% oxygen by volume, LEL is below 10%, and the concentration of each hazardous substance or contaminant(s) present in the space's atmosphere is below acceptable criteria outlined in the permit (below all exposure limits in most cases); or
- The confined space has an air exchange rate of at least 8 times/hour; or
- Per a consensus standard accepted by industry (e.g., API, ANSI, CEPA)

Proper set-up of a ventilation system for a confined space is critical to ensure its effectiveness and to minimize/control hazards and exposures. Consider the following:

- Eliminate "short-circuiting" of airflow around the fans or blowers by using an adaptor plate to bolt the fan to the flange of a man-way, or use any other safely feasible measure.
- Supply air needs to be ducted/hosed to deliver it to the work zone and exhaust air needs to be able to capture any contaminants that may be generated by work activities. The exhaust hood or duct should be placed 300 mm (1 ft.) from the source of the contaminant(s).
- A combination of pushing air in and pulling air out of the confined space is often the most effective. If a contaminant is heavier than air (e.g., crude oil vapors), the ventilation strategy should be to push air in from the top and channel exhaust air out from the bottom. However, if the contaminant is lighter than air (e.g., methane), the contaminant has a tendency to rise to the top of the space; thus, the ventilation strategy should be to push air in from the bottom and pull air out from the top.
- Ventilation should be continuous, where possible, if the source(s) of the hazardous atmosphere still exists, or if operations in the confined space generate contaminants or hazards that create a hazardous atmosphere.
- When a confined space has only a single man-way or opening, or has interior obstructions that decrease the effectiveness of dilution ventilation; local exhaust ventilation with a capture hood/duct placed at the source of contaminants is recommended.
- Confined spaces containing flammable gases or vapors may need to be purged with an inert gas prior to ventilating with air. If inert gases (e.g. nitrogen, argon, carbon dioxide) are used for inerting the confined space, the space shall be well-ventilated after the inerting is completed. Then the atmosphere shall be re-tested before any authorized entrant enters the space.
- Where flammable or combustible gases may be present, the ventilation equipment used shall be designed for use in such environments. The equipment shall also be properly grounded and bonded to prevent static electricity from potentially igniting a combustible source.
- Ensure venting activities do not create another hazard. For example, scrubbers may be applied to the venting exhaust to prevent buildup of contaminant in another location.

- If the location has an air permit, the release of emissions must not violate air permitting requirements. Refer to the Company Representative for further clarification.
- Ensure the make-up (fresh) air for the confined space is free of contaminants. Note that make-up air could be contaminated by:
 - Exhaust air that carries contaminants from work that is carried out within the confined space
 - Exhaust from nearby or adjacent fuel-operated equipment, such as generators, air compressors, vacuum trucks, or other vehicles
 - Vapors or substances arising from nearby or adjacent operations and processes, e.g., organic vapors from painting, silica from blasting operations, or lead from paint removal work

3.8.5 HOT WORK

Unless a qualified worker has determined that work can be performed safely, hot work shall not be performed in a confined space that contains:

- an explosive or flammable hazardous substance in a concentration in excess of 10% of its lower explosive limit; or
- oxygen in a concentration in excess of 23%

If these conditions are exceeded during hot work activities, the hot work shall stop and remain stopped until the conditions are deemed safe for work to continue. This determination shall be based on additional or subsequent air testing.

When performing hot work activities, a qualified fire watch person shall patrol the area surrounding the confined space until all fire hazards have passed per the Hot Work and Ignition Sources Specification. Appropriately rated fire extinguishers are required in the immediate area per the Emergency Preparedness-Personal Safety Specification.

3.8.6 ISOLATION REQUIREMENTS

Refer to the Control of Hazardous Energy Specification for additional information on isolation and control of energy. Each worker entering a confined space shall be adequately protected against isolation related hazards, as follows:

- Protect workers from the release of hazardous substances in the confined space by disconnecting, blanking, blinding or double block and bleed of piping, cribbing etc.
- Protect workers from contact with electrical energy inside the confined space by disconnecting, de-energizing, lockout and tagging the source of electrical energy.
- Protect workers from moving parts of equipment inside the confined space by disconnecting the equipment from its power source, de-energizing the equipment, ensuring there is no stored energy, locking and tagging all energy sources.
- Other adequate means of worker protection and hazard prevention are required if the above controls are not possible.

3.8.7 TOP-ENTRY CONFINED SPACES

If entrance into a confined space is from the top, the following requirements shall be met:

- each worker entering the space shall use an appropriate full-body harness and, where appropriate, be attached to a lifeline per the Fall Protection Specification.
- if a lifeline is used, the lifeline shall be attended by another Worker who is qualified to carry out the established rescue procedures
- a mechanical lifting device for rescue shall be located at the entry to the confined space and available for use during a rescue; the device shall be placed at the entrance at all times when one or more workers are in the confined space
- If the use of a full-body harness or lifeline could create an additional hazard, an alternate method of rescue shall be developed and implemented.

3.9 CONFINED SPACE RESCUE

Confined space rescue requirements will vary based on the classification of the space and any unique hazards identified. Every confined space entry requires:

- The services of one or more rescue personnel
- A documented Rescue Plan
- Personnel assigned rescue duties must be notified before workers enter a confined space and when all workers have exited from the space.
- If multiple confined spaces are being entered, notifying rescue personnel to be onsite in an alert status is sufficient, unless the confined space(s) are High hazard (IDLH) Atmosphere
- In cases where there is a contract for primary rescue personnel to provide 24-hour service, individual notification may not be required.
- Assigned rescue personnel must monitor any signaling system used to summon them while a confined space entry is underway or while on an alert status.
- Where an entry-rescue into a High Hazard (IDLH) atmosphere is a possible rescue scenario, the rescue team must remain at the confined space during the entry itself. The rescue team must have PPE donned, including SCBA or SABA with an escape bottle, and respirator masks at the ready.
- A rescue worker may not enter the confined space unless there is at least one additional worker located outside to render assistance.
- The confined space attendant may assist a rescue worker and may perform a non-entry rescue using an attached lifeline.

- In the event of rescuing an entrant involves physically entering the confined space, a rescue worker in addition to an existing confined space attendant will be required to execute a rescue (i.e., rescuer enters to extract the entrant, the attendant remains outside to render assistance).
- Once rescue is initiated, the Contractor on the scene is either (a) an Entry Supervisor with knowledge of the rescue procedure or (b) a qualified rescue worker.
- The most senior person present, not directly involved in the rescue shall trigger the site-specific Emergency Response Plan.
- The qualified confined space rescue team retains control over the rescue itself until the entrant is extracted.
- Rescue personnel must wear SCBA or SABA with an escape bottle in any rescue within a confined space with an unknown or IDLH atmosphere.
- Workers entering a space assessed as a “High Hazard (IDLH) Atmosphere” must wear a safety harness securely attached to a lifeline.
- The lifeline must be securely anchored outside the confined space.
- The confined space attendant is responsible to assist in ensuring the lifeline does not become entangled during entry and work inside.
- The confined space attendant must be able to extract the worker(s) without entering the space using the lifeline in an emergency and must be supplied with a mechanical device suitable and designed for confined space entry rescue, as required, to facilitate this type of rescue.
- This requirement does not apply if the lifeline itself creates a hazard or extraction with the lifeline would be impossible due to the configuration of the space.

Note: These lifeline requirements may also apply in “Low Hazard (Restricted Space) or Moderate Hazard (Non-IDLH) Atmosphere” spaces that have physical hazards (e.g., working at heights, engulfment, entrapment) that may be effectively controlled with a lifeline.

3.9.1 RESCUE PLAN

Confined spaces must have a formal rescue plan developed prior to space entry and maintained with other confined space entry documents. This plan is to be read and reviewed prior to initial entry by the Entry Team to:

- Ensure familiarity with the plan for all participants (entrants, confined space attendant, and rescue team) with the plan.
- Determine if any additional rescue provisions need to be prepared.

Note: A single rescue plan may be applicable to several confined spaces that share similar characteristics and hazards.

The Rescue Plan must include at a minimum:

- Information on the confined space
- Completed Hazard Assessment
- Site Layout
- Equipment necessary to complete a rescue
- Methodology of rescue
- Names of individuals that will be onsite performing the rescue
- Communication methodology
- Medical equipment necessary to be on site
- PPE requirements

Frequency and requirements to complete drills as outlined by regulatory requirements for that jurisdiction.

3.9.2 RESCUE EQUIPMENT

The selection of equipment must be appropriate for the confined space. All rescue equipment must be appropriately rated for its use. Equipment must have inspections documented and available for review.

3.10 CONFINED SPACE CLOSURE REQUIREMENTS

Once work is completed within a confined space, prior to final closure of the space, the following should be done:

- Final visual inspections to ensure no personnel or equipment are inside the space prior to closure.
- Ensure any active Permit is formally closed with required sign-offs complete.

3.11 CONFINED SPACE PACKAGE

When a contractor will be conducting confined space entries, this package will be provided to them from a Company representative all relevant documentation will be compiled and available prior to entry into a confined space. This Confined Space Package should include (as applicable):

- Worksite specific Confined Space Entry requirements
- Any specific identified Hazards as well as experience with the space, such as knowledge of hazardous conditions
- Applicable Safety Data Sheets
- Confined Space Permit
- Hazard Assessment
- Piping and Instrumentation Diagrams (P&IDs)

-
- Isolation drawings (identify isolation points, line breaks and blind locations)
 - LOTO form(s)
 - Procedures for tasks to be conducted in Confined Space

4.0 REFERENCES

Canadian Association of Petroleum Producers Code of Practice for Confined Space
CSA Z1006-16 Management of work in confined spaces

5.0 APPENDIX

5.1 IDENTIFICATION OF A CONFINED SPACE

Is This Space a “Confined Space”?

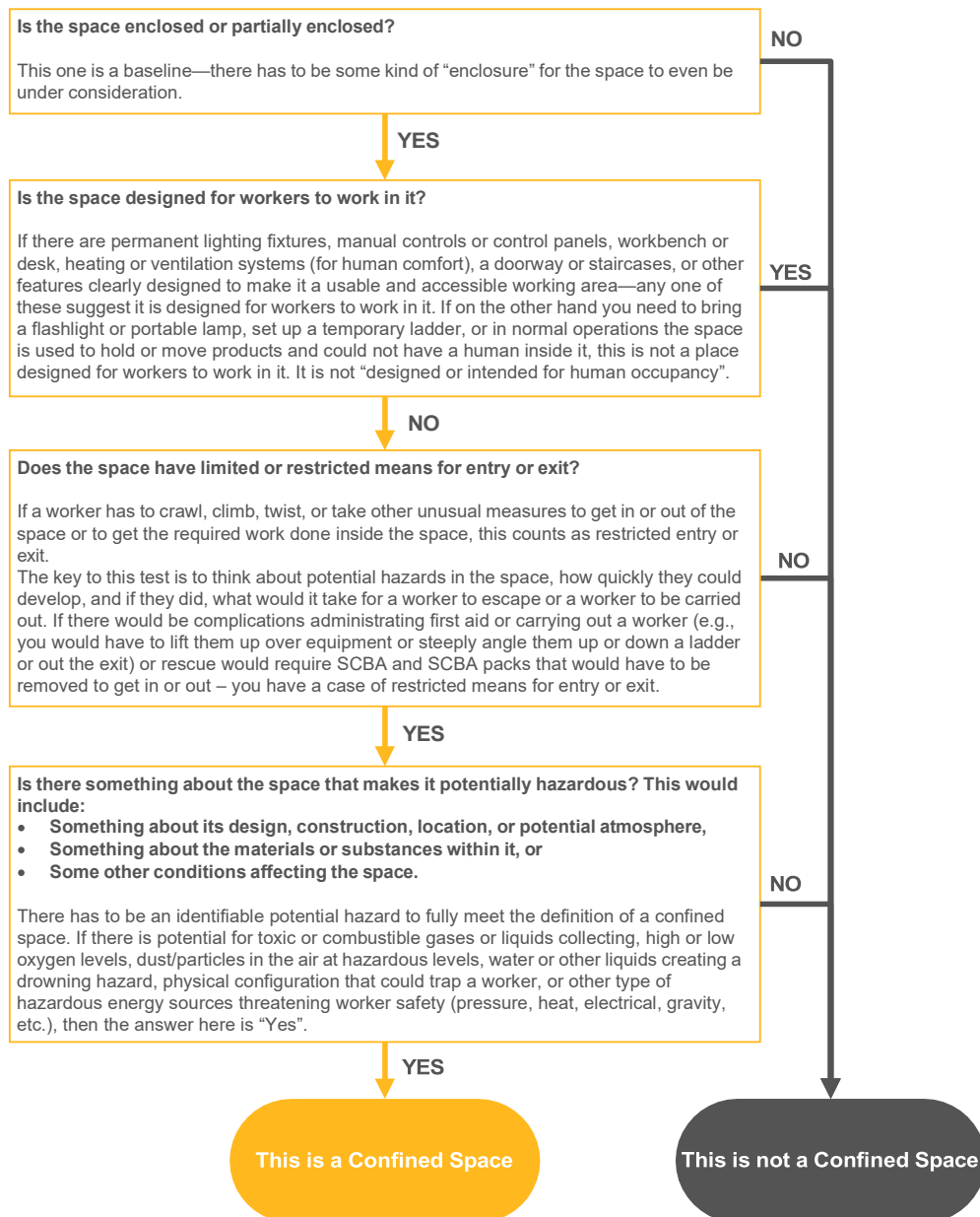

5.2 CONFINED SPACE ENTRY PERMIT

CONFINED SPACE ENTRY PERMIT - CANADA

000000

Part 1: Description	Date Permit Issued: _____ Contractor: _____ Site: _____																
	Time Permit Issued: _____ Time Permit Expires (12 hour max without extension): _____ Time Work Completed: _____																
Emergency Response Contact Info (e.g. phone #, radio channel): _____																	
Location of Confined Space to be Entered: _____																	
SWP #: _____ Is there an Isolation LOTO Form: <input type="checkbox"/> Yes <input type="checkbox"/> No If yes, attach. Other: _____																	
Type of Work: <input type="checkbox"/> Cold <input type="checkbox"/> Hot <input type="checkbox"/> Electrical – line side of 480v/500v main breaker (clearance/isolation form required)		Work Environment: <input type="checkbox"/> Hazardous Area <input type="checkbox"/> Restricted Area <input type="checkbox"/> Unclassified															
Description of Work: _____		Confined Space Class: <input type="checkbox"/> Class 1 / Restricted Space (Parts 1 – 6 of this permit is required) <input type="checkbox"/> Class 2 – Moderate Hazard Atmosphere - Non-IDLH Atmosphere <input type="checkbox"/> Class 3 – Severe Hazard Atmosphere – IDLH Atmosphere															
Part 2: Confined Space Entry Checklist	<ul style="list-style-type: none"> • Has the confined space location, hazards, and their controls, been reviewed and the confined space to be entered confirmed? <input type="checkbox"/> Yes <input type="checkbox"/> No • Has the hazard assessment been attached to the Permit? <input type="checkbox"/> Yes <input type="checkbox"/> No • Have all specific job responsibilities been assigned? (Indicate person responsible): Entry Supervisor – _____ Equipment Lockout – _____ Attendant – _____ Atmospheric Testing – _____ Preparation requirements completed prior to entry (cleaning, purging, venting, inerting, etc.): _____ 																
	<ul style="list-style-type: none"> • Have all entry points into the confined space been identified and properly secured against unauthorized entry? <input type="checkbox"/> Yes <input type="checkbox"/> No • Is required monitoring equipment available and calibrated? <input type="checkbox"/> Yes <input type="checkbox"/> No • Is required rescue equipment available? <input type="checkbox"/> Yes <input type="checkbox"/> No • Do all personnel have required training? (Including those not entering confined space) <input type="checkbox"/> Yes <input type="checkbox"/> No • Are all pertinent SDS available and have they been reviewed? <input type="checkbox"/> Yes <input type="checkbox"/> No • Are there any ventilation / equipment required? (i.e. air movers, nitrogen purge, etc.) <input type="checkbox"/> Yes <input type="checkbox"/> No • Have lockout and isolation points been verified and tested? <input type="checkbox"/> Yes <input type="checkbox"/> No • Have all required information and materials been provided to the contractor performing the confined space entry (if applicable): <input type="checkbox"/> Yes <input type="checkbox"/> No 																
Attachments: <input type="checkbox"/> Hazard Assessment <input type="checkbox"/> Rescue Plan <input type="checkbox"/> SOS <input type="checkbox"/> Ventilation Plan (as required) <input type="checkbox"/> Other _____																	
Conditions Under Which Entry is to be Terminated: _____																	
Part 3: Air Testing Requirements	Tester's Name: _____ Testing Equipment/ Methods: _____ Calibration Date: _____ Bump Date: _____ Frequency of Atmospheric Testing (results must be recorded at the interval): _____ Personal Monitors Required for Entrants? <input type="checkbox"/> Yes <input type="checkbox"/> No <input type="checkbox"/> Continuous for O ₂ , LEL, H ₂ S, CO (mandatory) <input type="checkbox"/> Other toxins to be tested: _____ Frequency of testing: _____ _____ Frequency of testing: _____ _____ Frequency of testing: _____																
	<table border="1" style="width: 100%; border-collapse: collapse;"> <thead> <tr> <th style="width: 50%;">Initial Air Test</th> <th style="width: 50%;">Results</th> </tr> </thead> <tbody> <tr><td>O₂</td><td></td></tr> <tr><td>H₂S</td><td></td></tr> <tr><td>LEL</td><td></td></tr> <tr><td>CO</td><td></td></tr> <tr><td>Benzene</td><td></td></tr> <tr><td>Other:</td><td></td></tr> <tr><td>Tester's Initials:</td><td></td></tr> </tbody> </table>		Initial Air Test	Results	O ₂		H ₂ S		LEL		CO		Benzene		Other:		Tester's Initials:
Initial Air Test	Results																
O ₂																	
H ₂ S																	
LEL																	
CO																	
Benzene																	
Other:																	
Tester's Initials:																	
Acceptable atmospheric levels for this space (O ₂ , LEL, H ₂ S, CO, benzene, etc): _____																	
Reminder: Tests shall be performed and recorded before a worker enters or re-enters the space. Initial testing must be performed no more than 20 minutes prior to an entry. Atmospheric testing must be repeated within 20 minutes of entry if a confined space is vacated for more than 20 minutes.																	
Part 4: Onsite Escalation & Rescue	Are we using an internal Enbridge team for rescue? <input type="checkbox"/> Yes <input type="checkbox"/> No External Third Party Rescue: <input type="checkbox"/> Yes <input type="checkbox"/> No If yes, name of external vendor: _____ How is the rescue team summoned or communicated with (cellphone / radio, etc.): _____ Equipment required for rescue: _____ Nearest Medical Facility: _____ Names of Rescue Team Members: _____																
	Work cannot begin until the required signatures are on this document. All persons performing this work must comply with Enbridge safety policies and government regulations. Work must stop should conditions change/new hazards appear or an emergency occurs on the site.																
Part 5: Approvals	Permit Issuer: _____ Permit Approver / Entry Supervisor: _____ Permit Receiver: _____																
	Print Name: _____ Print Name: _____ Print Name: _____ Signature: _____ Signature: _____ Signature: _____																
By signing this permit, the receiver acknowledges that all safety requirements have been met, have been reviewed with the workers, will be maintained for the duration of the permit and it is safe to proceed with the work. All workers associated with the work must sign in the area provided on the back of the permit during the pre-job entry meeting.																	
Record of Permit Closure: Job Completed? <input type="checkbox"/> Yes <input type="checkbox"/> No Have all personnel vacated the space? <input type="checkbox"/> Yes <input type="checkbox"/> No Have all tools/equipment been removed from the space? <input type="checkbox"/> Yes <input type="checkbox"/> No																	
Permit Extension: Is the planned work expected to exceed 12 hours? _____																	

White copy: Permit Receiver

Yellow copy: Permit Issuer
Permit Continued on Reverse->

Part 6: Pre-Entry Meeting:									
Confined Space Entry Supervisor or Designate (print and sign): _____ This signature authorizes the entry of the following workers into the confined space.									
Workers Involved (print and sign)									
1. _____	8. _____	15. _____							
2. _____	9. _____	16. _____							
3. _____	10. _____	17. _____							
4. _____	11. _____	18. _____							
5. _____	12. _____	19. _____							
6. _____	13. _____	20. _____							
7. _____	14. _____	21. _____							
Topics to be reviewed (as applicable):									
<input type="checkbox"/> Hazard Assessment and Controls (Mandatory Review) <input type="checkbox"/> Rescue plan (Mandatory Review) <input type="checkbox"/> Confined Space Classification <input type="checkbox"/> Confined Space Entry Checklist <input type="checkbox"/> Procedures/plans to be followed <input type="checkbox"/> Permit Requirements <input type="checkbox"/> Communication Systems					<input type="checkbox"/> Air-Testing Requirements <input type="checkbox"/> Confined Space Attendant Responsibilities <input type="checkbox"/> Ventilation <input type="checkbox"/> Required personal protective and respiratory equipment required for entry <input type="checkbox"/> Entrant tracking requirements (sign in/out with confined space attendant) <input type="checkbox"/> Conditions under which entry is not allowed or must be terminated <input type="checkbox"/> Emergency equipment and inspection of equipment <input type="checkbox"/> Isolation of energy sources and control of materials movement				
Pre-Entry Meeting Notes:									
Part 7: Periodic Atmospheric Testing Results									
Time of Test									
Tester's Name									
Tester's Initials									
O ₂									
H ₂ S									
LEL									
CO									
Benzene									
Other (Specify) _____									
Other (Specify) _____									
Part 8: Entrant Tracking (Completed by the Confined Space Attendant)									
Confined Space Attendant Name: _____					Confined Space Attendant Signature: _____				
Entrant Name (First and Last)	Entry Time	Exit Time	Entry Time	Exit Time	Entry Time	Exit Time	Entry Time	Exit Time	Exit Time
1.									
2.									
3.									
4.									
5.									
6.									
7.									
8.									
9.									
10.									
11.									
12.									
13.									
14.									
15.									
16.									
Confined Space Attendant Notes:									
<input type="checkbox"/> Communication system with entrants: _____ <input type="checkbox"/> Communication system with Entry Supervisor: _____ <input type="checkbox"/> Communication system with rescue team: _____									

White copy: Permit Receiver

Yellow copy: Permit Issuer



Contractor Safety Specification

Confined Space – United
States

Table of Contents

1.0	Definitions & Acronyms.....	4
2.0	Contractor Responsibilities	7
3.0	Specification Requirements	11
3.1	Confined Space Hazard Assessment	11
3.2	Control of Hazards	14
3.3	Types and Classifications of Confined Spaces	15
3.3.1	Three Categories for Confined Space Entry.....	16
3.3.2	Confined Space Requirements	17
3.3.3	Temporary Declassified Space.....	18
3.3.4	Trenches and Excavations	19
3.3.5	Minimal Depth Whistles/Vertical Culverts.....	19
3.3.6	Small Piping	19
3.3.7	External Floating Tank Roofs.....	19
3.4	Confined Space Entry Plan.....	20
3.5	Pre Entry Meeting	20
3.6	Confined Space Entry Permit	22
3.6.1	Confined Space Permit Roles	22
3.6.2	Terminating an Entry	24
3.6.3	Permit Document Copies	25
3.7	Work Practices.....	26
3.7.1	Preventing Unauthorized Entry	26
3.7.2	Atmospheric Testing/Monitoring.....	26
3.7.3	IDLH Atmosphere.....	27
3.7.4	Inerting	28
3.7.5	Ventilation Requirements	28
3.7.6	Hot Work	30
3.7.7	Isolation Requirements.....	30
3.8	Confined Space Rescue	31
3.8.1	Third Party Rescue Teams.....	32

3.8.2	Rescue Plan	33
3.9	Confined Space Closure Requirements	34
3.10	Confined Space Package.....	34
4.0	References.....	35
5.0	Appendix.....	36
5.1	Identification of a Confined Space.....	36
5.2	Confined Space Entry Permit	37
5.3	Confined Space Rescue Plan – Template.....	39
5.4	Confined Space Entry Plan – Template.....	42

1.0 DEFINITIONS & ACRONYMS

Acceptable Entry Conditions - the conditions that must exist in a permit space to allow entry and to ensure that workers involved with a permit-required confined space entry can safely enter and exit into and work within the space. Prior to an entry, all access points for entry and exit will need to be determined.

Blanking – isolation method for the absolute closure of piping that involves inserting a physical barrier through the cross-section of pipe so material is prevented from flowing past that point. Blanks shall be of sufficient rating to withstand the highest possible pressure that may result.

Blinding – isolation method for the absolute closure of piping that involves disconnecting a pipe and attaching a physical barrier to the end so material is prevented from flowing out of the pipe. Blind flanges used for this purpose shall be of sufficient rating to withstand the highest possible pressure that may result.

Company Representative – employee or third party hire representing the Company for specific contractor work or project.

Confined Space - a space that:

- Is large enough and so configured that an person can bodily enter and perform assigned work; and
- Has limited or restricted means for entry or exit (for example, tanks, vessels, silos, storage bins, hoppers, vaults, and pits are spaces that may have limited means of entry.); and
- Is not designed for continuous employee occupancy.

Confined Space Attendant - a qualified worker who is stationed outside one or more permit spaces who monitors the authorized entrants and who performs all attendants' duties assigned in the employer's permit space program.

Confined Space Authorized Entrant - a qualified worker who is authorized by the employer to enter a space.

Confined Space Entry Supervisor - the qualified person responsible for determining if acceptable entry conditions are present at a confined space where entry is planned, for authorizing entry and overseeing entry operations, and for terminating entry as required by this section.

*Note: An Entry Supervisor also may serve in additional roles as long as that person is trained and equipped as required by this section for each role he or she fills. Also, the duties of Entry Supervisor may be passed from one individual to another during the course of an entry operation.

Emergency - any occurrence (including any failure of hazard control or monitoring equipment) or event internal or external to the permit space that could endanger authorized entrants.

Enbridge- Enbridge, Inc. and Enbridge (U.S.) Inc., hereinafter will be referred to as “Company”.

Engulfment - the surrounding and effective capture of a person by a liquid or finely divided (flowable) solid substance that can be aspirated to cause death by filling or plugging the respiratory system or that can exert enough force on the body to cause death by strangulation, constriction, or crushing.

Entry - the action by which a qualified person passes through an opening into a permit required confined space. Entry includes ensuing work activities in that space and is considered to have occurred as soon as any part of the authorized entrant's body breaks the plane of an opening into the space.

Entry Permit - the written or printed document that allows and controls entry into a confined space.

Flammable Atmosphere - any atmosphere that contains 10% or more of the Lower Explosive Limit (LEL), or Lower Flammable Limit (LFL) for any substance.

Hazardous Atmosphere - An atmosphere which exposes an individual to a risk of injury, illness, disablement, or death due to one or more of the following causes:

- A flammable gas/vapor concentration in excess of 10% of its lower explosive limit (LEL)
- An atmospheric oxygen concentration below 19.5% or above 23.5%.
- An atmospheric concentration of any substance above the exposure limits established by the governing regulatory body or as indicated on the Safety Data Sheet (SDS)
- Airborne combustible dust at a concentration that meets or exceeds its LFL;
*Note: This concentration may be approximated as a condition in which the dust obscures vision at a distance of 5 feet (1.52 m) or less.

Hot Work - Any process that can be a source of ignition when flammable material is present or can be a fire hazard regardless of the presence of flammable material.

Immediately Dangerous to Life and Health (IDLH) Atmosphere- An atmospheric concentration of any toxic, corrosive or asphyxiant substance that poses an immediate threat to life or would cause irreversible or delayed adverse health effects or would interfere with an individual's ability to escape from a dangerous/hazardous atmosphere.

Inerting - the displacement of the atmosphere in a permit space by a non-combustible gas (such as nitrogen) to such an extent that the resulting atmosphere is non-combustible.

*Note: This procedure produces an IDLH oxygen-deficient atmosphere.

Isolated - Sources of energy have been disconnected or controlled.

Isolation - the process by which a confined space is removed from service and completely protected against the release of energy and material into the space by such means as: blanking

or blinding; misaligning or removing sections of lines, pipes, or ducts; a double block and bleed system; lockout or tagout of all sources of energy; or blocking or disconnecting all mechanical linkages.

LOTO – lockout tagout

Lower Explosive Limit (LEL) - The lowest concentration (percentage) of a gas or a vapor in air capable of producing a flash of fire in presence of an ignition source (arc, flame, heat). At a concentration in air below the LEL there is not enough fuel to continue an explosion. Concentrations lower than the LEL are "too lean" to explode but may still burn with great heat and light. Exact values can be found on product's SDS.

Non-Permit Confined Space - means a confined space that does not contain or, with respect to atmospheric hazards, have the potential to contain any hazard capable of causing death or serious physical harm. This includes temporarily reclassified confined spaces.

Oxygen Deficient Atmosphere - means an atmosphere containing less than 19.5% oxygen by volume.

Oxygen Enriched Atmosphere - means an atmosphere containing more than 23.5% oxygen by volume.

Permit-required confined space - means a confined space that has one or more of the following characteristics:

- Contains or has a potential to contain a hazardous atmosphere;
- Contains a material that has the potential for engulfing an entrant;
- Has an internal configuration such that an entrant could be trapped or asphyxiated by inwardly converging walls or by a floor which slopes downward and tapers to a smaller cross-section; or
- Contains any other recognized serious safety or health hazard.

Prohibited Condition - means any condition in a permit space that is not allowed by the permit during the period when entry is authorized.

Qualified- Confined Space Roles – A worker who has acquired the understanding, knowledge and skills necessary for the safe performance of the assigned confined space duties.

Rescue Team - means the personnel designated to rescue workers from permit spaces.

Retrieval system - means the equipment (including a retrieval line, chest or full-body harness, wristlets or anklets, if appropriate, and a lifting device or anchor) used for non-entry rescue of persons from permit spaces.

SABA – Supplied Air Breathing Apparatus

SCBA – Self-Contained Breathing Apparatus

SWP – Safe Work Permit

Toxic Atmosphere – means an atmospheric concentration of any substance above the exposure limits established by the governing regulatory body or as indicated on the Safety Data Sheet (SDS).

2.0 CONTRACTOR RESPONSIBILITIES

Contractor management shall:

- Ensure compliance with all Applicable Legislation and Company requirements including, but not limited to:
 - ensuring work is conducted in accordance with this Standard, Confined Space Entry Permit, Entry Plan and Hazard Assessments, and any procedures established as a result of this Standard
 - ensuring an Entry Supervisor who is qualified is assigned for each confined space entry
 - ensuring all Workers involved in Confined Space work are qualified and have completed applicable Confined Space training
 - ensuring Confined Space rescue plans are developed prior to an entry
 - ensuring all required documentation applicable to Confined Space entry is developed, completed and maintained, in accordance with Company requirements and applicable Legislation
 - ensuring all resources (e.g., personnel, equipment, personal protective equipment (PPE)) required for each Confined Space Entry are readily available
 - ensure that contractors are informed of the hazards and controls associated with confined space entries.

Company Projects shall:

- Identify all confined spaces for their project work
- Coordinate all confined space entries with Operations for sites Operations has ownership of
- Coordinate contractor confined space entries on their sites with the work group who is performing the work
- Ensure compliance with the signage requirements for confined spaces
- Follow all procedures and standards when performing a confined space entry
- Maintain communications with the contractor throughout the planning, execution and completion of confined space activities.
- Debrief the contractor at the conclusion of the entry operations regarding any hazards confronted or created in during entry operations.

Entry Supervisor at a minimum shall:

- Ensure all confined space entry and regulatory requirements are met prior to the confined space entry permit being issued.
- Verify compliance with the requirements on the Confined Space Entry Permit
- Ensure all workers are qualified to perform their assigned tasks and roles
- Know the hazards that may be faced during entry work, including information on the potential modes of exposure, plus the signs, symptoms and consequences of different exposures
- Ensure a hazard assessment is completed prior to entry and reviewing the hazard assessment with the workers. This process includes a FLHA at a minimum. If a JHA or a confined space hazard assessment exists, it should be reviewed with the workers.
- Conduct the confined space pre-job entry meeting
- Conduct and oversee the work in accordance with the pre-job entry meeting if applicable
- Ensure workers follow the requirements set out during the Pre-Job Entry Meeting if applicable
- Ensure adequate steps have been taken to eliminate and/or control all present or potential hazards
- Verify hazard controls are implemented and effective
- Ensure all required atmospheric monitoring and testing has been completed as required by the hazard assessment and confined space plan and is properly documented
- Ensure that rescue personnel, plans, and equipment are in place if applicable
- Ensure there is a suitable means of communication among workers
- Ensure that acceptable conditions are maintained for the duration of the entry work and that any requirements or status changes are communicated to the next Entry Supervisor if applicable
- Terminate the confined space entry and permit if conditions warrant termination

*Note: this role can be either an Company employee or contractor. A contractor Entry Supervisor cannot be the approver on an Operations-generated Confined Space Permit. The approver will be either operations or projects.

Confined Space Attendant at a minimum shall:

- Attend and participate in the confined space pre-job entry meeting

- Review the entry and rescue procedures, being aware of all confined space entry permit and hazard assessment requirements and ensuring all requirements are followed
- Be aware of the hazards of the confined space being entered
- Be aware of the signs and symptoms of exposures and the possible behavioral or other effects of exposure
- Ensure they have an effective means of constant communication with the workers entering the confined space, the emergency rescue personnel and the Entry Supervisor at all times
- Ensure initial and ongoing air testing occurs, as required, and recording the test results on the confined space entry permit
- Ensure entry points are kept clean and clear
- Control access to the confined space and prohibit entry to unauthorized workers
- Track and record on the confined space entry permit, all personnel entering and exiting a confined space, and controlling the number of authorized entrants within the space as required by the confined space entry permit
- Be aware of hazardous, prohibited or unacceptable conditions that require evacuation of the space
- Be prepared to initiate evacuation from the space, as necessary, due to actual or potential hazards (this could include hazards within the space and also in the vicinity of the space that could affect the health and safety of workers)
- Ensure the space has been completely evacuated in the event of an emergency
- Request rescue and other emergency services when necessary, e.g., as soon as it is determined that workers in a confined space may need assistance to evacuate; or, if a situation arises outside the confined space that could endanger the workers inside or near the confined space
- Not enter a confined space for any reason or leave the entrance to a confined space, unless relieved by another designated and qualified attendant
- Not enter the space to perform rescue operations, if qualified for rescue work in accordance with the rescue procedure for that confined space unless they have been relieved by another attendant
- Not perform other duties which might interfere with their primary duty to monitor and protect the authorized entrants working in the space, unless they are performing non- entry rescue in accordance with the rescue procedure

- Verify that no person is inside the confined space before it is closed off, and shall ensure proper signage/barricades are in place to prevent unauthorized entry into the confined space prior to leaving the entrance of a confined space

Authorized Entrant at a minimum shall:

- Attend and participate in the confined space pre-job entry meeting
- Review the entry and rescue procedures, being aware of all confined space entry permit and hazard assessment requirements and ensuring all requirements are followed
- Be aware of the hazards of the confined space being entered
- Immediately notify the Entry Supervisor when they do not feel qualified to perform a task or assigned duty
- Conduct work as directed by the Entry Supervisor, and in accordance with company requirements
- Alert the Entry Supervisor when a hazard has not been adequately controlled
- Be aware of the signs and symptoms of exposures and the possible behavioral or other effects
- Maintains communication with the attendant and immediately notifies the attendant if an emergency or a hazardous, prohibited or unacceptable condition requires evacuation of the confined space
- Exit the space as quickly as possible when any of the following occurs:
 - the attendant gives the order to evacuate the space
 - An emergency
 - A hazardous, prohibited or unacceptable condition is detected
 - An evacuation alarm is activated
- Properly use equipment
- Wear/use the required equipment (e.g., PPE, respiratory protection equipment, rescue equipment) properly, in a safe manner and at all times
- Know the limitations of equipment used to control hazards related to confined space entry work
- Sign in and sign out of the confined space with the attendant

Rescue Personnel at a minimum shall:

- Ensure all retrieval equipment is in good working order

- Ensure that the proper rescue equipment is readily available and in close proximity to the confined space.
- Writes or is involved in the writing and review of the confined space rescue plan
- Review the confined space and understands the hazards and controls

Entry Coordinator for Contractors shall:

- Coordinate the planning for a confined space entry.
- Communicate and coordinate with contractors when contractors are performing a confined space entry.
- Provide the Permit Issuer with adequate notice of intended entry to review scope, hazards and confined space documentation.
- Communicate with Operations
- Communicate with the contractor as applicable
- Communicate with the Entry Supervisor
- Ensure all information on the confined space is obtained from Operations and provided to the contractor and Entry Supervisor
- Coordinate isolation with Operations if applicable
- Reviewing the contractor's confined space entry program/procedures applicable to the work
- Reviewing the contractor's rescue plan
- Ensuring all policies and procedures are followed.

Note: The individual performing this role should be from the work group that is hiring the contractor. The role does not need to be onsite during any time of the actual confined space entry.

3.0 SPECIFICATION REQUIREMENTS

3.1 CONFINED SPACE HAZARD ASSESSMENT

A confined space hazard assessment is encouraged to identify hazards and controls with existing permanent confined space.

When completing a confined space hazard assessment, the qualified worker is responsible for identifying and assessing existing and potential hazards specific to the work activity and related job tasks that may exist due to the design, construction, location, use or contents of the confined space that may develop while work is done inside the confined space.

If two or more confined spaces are of similar construction and present the same hazards, their confined space hazard assessments may be recorded in a single document, but each confined space shall be clearly identified in the assessment.

For Permit Required Confined Spaces the confined space hazard assessment must also consider specified risks including:

- the conditions which may exist prior to entry due to the confined space's design, location or use, or which may develop during work activity inside the space, and
- the potential for oxygen enrichment and deficiency, flammable gas, vapour or mist, combustible dust, other hazardous atmospheres, harmful substances requiring lockout and isolation, engulfment and entrapment, physical and configuration hazards, emergency response limitations, and other hazardous conditions.

Factors to be considered in the confined space hazard assessment include:

- Hazardous atmospheres either as a normal characteristic of the space or as the product of the required work processes to be conducted in the space:
 - Oxygen Deficiency or Enrichment: Oxygen deficiency may be caused by consumption by workers, oxidation (rusting) process, burning, welding, or bacteria, or by the absorption by chemicals or products. An oxygen deficient atmosphere is one that contains less than 19.5% oxygen. Oxygen enrichment may be caused by leaking of oxygen into the space or generation by chemical processes. An oxygen enriched atmosphere is one that contains more than 23.5% oxygen.
 - Asphyxiates: Inert gases can dilute or displace oxygen below a safe level (e.g., methane, carbon monoxide, carbon dioxide, nitrogen) during purging or by leaking into the confined space due to improper isolation and lockout.
 - Toxicity: Gases (H₂S, Methane, CO, etc.), vapours, dusts, or fumes that have a poisonous effect from operations such as cleaning, painting, coating, etc., or from gases like methane or H₂S leaking into the confined space. Carbon monoxide may be generated by internal combustion engines within the confined space or running near air intakes for the ventilator in use. A toxic atmosphere is an atmospheric concentration of any substance above the exposure limits established by the governing regulatory body or as indicated on the Material Safety Data Sheet (MSDS/SDS).
 - Flammable or Explosive Atmospheres: Flammable gases (methane, ethane, etc.), vapors, dust that could be ignited by an uncontrolled ignition source. This risk increases if an oxygen-enriched atmosphere (23.5% by volume) is present.
 - Vapors, Mists, or Dusts.

- Harmful energy sources requiring isolation and lockout to ensure they remain in a zero-energy state.
- Uncontrolled introduction of water, liquids, steam, or gases (improper control of water, steam, or pressurized gases introduced during cleaning or surface preparation work).
- Contact with moving parts (being trapped or crushed by moving parts not properly isolated/locked out).
- Crushing/Engulfment or entrapment (risk of becoming trapped or buried by internal components or bulk materials).
- Entry and exit to the confined space sufficient for emergency egress and size adequate to allow personnel wearing respiratory equipment, if required by conditions.
- Other hazards resulting from work or equipment being used, such as:
 - Electrical hazards (including static),
 - Excessive temperatures - heat or cold,
 - Noise,
 - Falls/slips,
 - Radiation,
 - Direct contact with corrosives,
 - Iron sulphide (pyrophoric material), or
 - Biological substances (e.g., bird or rodent droppings) or stinging/biting insects and snakes.
- Tools required to be used in the work.

If a hazardous condition develops in a space during the entry, the work activity will be suspended and the confined space hazard assessment will need to be reviewed and updated as applicable before work resumes in the confined space.

The confined space hazard assessment review shall evaluate the effectiveness of hazard assessment process regarding the confined space and the suitability of established controls. The review of controls shall be based on relevant factors, such as:

- changes in workplace conditions or work activities
- workplace inspection reports
- injury statistics
- incident investigations

- the applicable Safety Data Sheet (SDS) of any hazardous products that were contained in the Confined Space or that could be released.

3.2 CONTROL OF HAZARDS

Risks associated with a confined space may be reduced by:

- Elimination:
 - Eliminate the confined space by eliminating the need to enter the space
 - Eliminate the confined space by modifying the configuration of the space.
- Substitution:
 - Utilizing tools in lieu of a traditional entry
 - Confined space work is contracted to a qualified contractor to perform
- Engineering Controls:
 - Ventilation to maintain the oxygen level between 19.5% and 23.5%
 - Ventilation to ensure clean breathable air is continuously blown into the space
 - Isolation to remove or separate equipment from all energy sources and appropriate control the energy through lockout
 - Eliminate the confined space by modifying the configuration of the space
 - Providing pedestrian, vehicle, or other barriers as necessary to protect entrants from external hazards
- Administrative Controls
 - Procedures for continuous atmospheric monitoring
 - Permits and planning for confined space entry and rescue
 - Procedures and guidelines for confined space entry
- Personal Protective Equipment (PPE)
 - Personnel may be required to wear an appropriate level of respiratory protection, full body harness, lifeline, and other PPE as necessary that is identified in the hazard assessment and as per company policy. A harness and lifeline should be worn to facilitate non-entry rescue at all times unless the retrieval equipment would increase the overall risk of entry or would not contribute to the rescue of the entrant. Guidance on proper selection of PPE is covered in Personal Protective Equipment, Fall Protection Specification and Respiratory Protection Specification.

- The Respiratory Protection Specification, Section 6.3, outlines the minimum respiratory protection requirements for exposures.

3.3 TYPES AND CLASSIFICATIONS OF CONFINED SPACES

Confined spaces are at most locations. Spaces that typically meet the definition of confined spaces on the company's property include, but are not limited to:

- Tanks
- Vaults
- Culverts
- Pressure vessels
- Pits
- Some parts of machinery
- Ventilation systems
- Access openings (manholes)
- Pipes
- Towers (heaters)
- Railway tank cars

When considering work that must be performed inside a Confined Space, the following priorities should be followed:

1. If possible, conduct the work from outside the Confined Space (i.e., avoid Entry altogether)
2. If #1 is not possible, remove all hazards capable of causing death or physical injury and any potential for a hazardous atmosphere to permanently or temporarily classify the Confined Space as a Non-Permit Required Confined Space.
3. If #2 is not possible, remove all hazards capable of causing death or physical injury and use mechanical ventilation as necessary to prevent a hazardous atmosphere to allow for an Alternate Entry into a Permit Required Confined Space.

Whenever feasible, eliminate atmospheric or other hazards and confirm hazards have been eliminated from the confined space from outside the confined space to avoid entry.

- Where entry is required to eliminate hazards and/or to confirm hazards are eliminated, the entry must be performed under the Permit Required Confined Space Specification Entry procedure.

When determining if a space is a confined space, see Appendix 5.1 Identification of a Confined Space for additional guidance.

3.3.1 THREE CATEGORIES FOR CONFINED SPACE ENTRY

Within the *OSHA Confined Space Regulations*, there are three categories for Confined Space Entry:

- **Standard Entry into a Permit Required Confined Space**

A permit required confined space is one that meets the definition of a confined space and contains or has the potential to contain a hazardous atmosphere, physical hazards, or biological hazards. These spaces have a higher risk associated with them that has the potential to exist even with controls in place. All the requirements of permit space entries apply such as the use of a Confined Space Permit, Attendant, Rescue Personnel, and extraction equipment.

Company Regional/ Business Unit Directors or assigned designate shall endorse (can be written, verbal, or electronic communication) the Confined Space Standard Entry plan.

- **Alternate Entry into a Permit Required Confined Space**

When the only hazard associated with an entry is actual or potential hazardous atmosphere that can be successfully controlled with mechanical ventilation, alternate procedures may be used. In this case, rescue personnel are not required. Authorized entrants will be required to vacate the space if a hazardous atmosphere develops. The confined space must not contain hazards due to one or more of the following:

- Materials or substances within the confined space
- Presence of a material (e.g., liquid, abrasive blasting materials) that pose an engulfment hazard
- Work activity that creates or has the potential to create a hazardous condition (e.g., painting, coating, welding, abrasive blasting, and pulling back tank seals) that the implemented hazard controls cannot address.
- Design, construction, internal configuration, or location such that a worker could become trapped.

*Note: The OSHA Standard requires when there is "any other recognized serious safety and health hazard" as one of its hazard characteristics results in a confined space being classified as a permit space. The intention of this requirement is not to apply to the mere presence of non-specific hazards such as physical, biological, or other. The intent is when there is a hazard that is immediately dangerous to life or health or one that impairs the employee's ability to perform self-rescue, then alternate entry should not be utilized.

- **Entry into Non-Permit Required Confined Space**

A confined space is one that meets the definition of a confined space, but through the control of hazards does not meet the criteria of a permit required confined space. These types of spaces do not have the ability to be reconfigured, where they are no longer a confined space. The hazards may be controlled through isolation, ventilation, or other means that eliminates actual and potential physical, chemical and biological hazards.

For this type of work, serious hazards and the potential for a hazardous atmosphere have been fully eliminated (without any further need for mechanical ventilation), allowing work to be conducted without a Confined Space Entry Permit. If a space is only temporarily being classified as a Non-Permit Required Confined Space (i.e., under normal conditions or certain conditions it would be a Permit Required Confined Space), the remediation work to reclassify and testing to establish it is no longer a Permit Required Confined Space need to be documented.

Note: Control of atmospheric hazards through forced air ventilation does not constitute elimination of the hazards.

3.3.2 CONFINED SPACE REQUIREMENTS

Requirement	NON-PERMIT REQUIRED CONFINED SPACE	PERMIT REQUIRED CONFINED SPACE Standard Procedure	PERMIT REQUIRED CONFINED SPACE Alternate Entry
Confined Space Entry Permit	Not Required	Required	Required
Written Procedure / Entry Plan	Follow site emergency response plan	Entry Plan Required *For predictable, routine entry, (e.g., pigging or installing vapor tools) an entry template procedure can be completed in lieu of an entry plan and rescue plan	Entry plan required. A confined space entry template or procedure can be completed in lieu of an entry plan and rescue plan.
Safe Work Permit	Safe Work Permit required for all contractor work activities.		
FLHA	Required		
Atmospheric Monitoring	Required		Required – Authorized entrants will be required to vacate the space if a hazardous atmosphere develops. •Oxygen levels that are below 19.5%, •LEL greater than 10%, •H2S greater than 10 PPM, •Carbon Monoxide levels greater than 35 PPM, •or Benzene levels greater than 0.5 PPM)
Working Alone	Working alone is allowed.	Working alone is not allowed	

Requirement	NON-PERMIT REQUIRED CONFINED SPACE	PERMIT REQUIRED CONFINED SPACE Standard Procedure	PERMIT REQUIRED CONFINED SPACE Alternate Entry
Ventilation	As required to maintain acceptable criteria		
Isolation and LOTO	May be required depending on the work activities to be performed. If applicable complete appropriate process for isolation and LOTO per requirements.		
PPE	As required in the PPE Specification.	As required in the PPE Specification. SCBA / SABA/Escape Pack may be required when the entire space cannot be verified prior to entry, then authorized entrants may switch to the level required by actual readings and/or site requirements	As required in the PPE Specification. Tank roof entry may require the usage of a SCBA / SABA/Escape Pack until the levels for the work area are confirmed to be acceptable, then authorized entrants may switch to the level required by actual readings and/or site requirements.
Rescue Plan	Required. Options must be developed to address medical emergencies not related to confined space entry, e.g., a broken bone in the space. This is based on the assumption that there is not an actual or potential hazardous atmosphere. A facility emergency action plan can be used to meet this requirement.	Required *For predictable, routine entry, (e.g., pigging or installing vapor tools) an entry template procedure can be completed in lieu of an entry plan and rescue plan	Required. Options must be developed to address medical emergencies not related to confined space entry, e.g., a broken bone in the space. This is based on the assumption that there is not an actual or potential hazardous atmosphere. A facility emergency action plan can be used to meet this requirement.
Rescue Team	Not Required	Required	Not required
Rescue Equipment	May be required depending on the rescue plan.	Required	May be required depending on the rescue plan.
Confined Space Training	Required		
Additional Personnel Required	None	Attendant Entry Supervisor Rescue Team	Attendant Entry Supervisor One person may fulfill both roles
Pre-Job Entry Meeting	None	Required	Required

3.3.3 TEMPORARY DECLASSIFIED SPACE

A temporary declassified confined space is one that started as a confined space, but through control of all actual or potential hazards no longer meets the definition of a confined space (e.g., no longer has limited means for entry and exit, etc.). An example of this would include a tank that has been degassed, cleaned, and has a door sheet removed. In this situation, the workers will

still need to consider all applicable safety standards, e.g., atmospheric monitoring, PPE, Respiratory Protection, etc.

3.3.4 TRENCHES AND EXCAVATIONS

A trench or excavation is not considered a confined space. However, a confined space may exist within an excavation, e.g., entry into a pipe.

3.3.5 MINIMAL DEPTH WHISTLES/VERTICAL CULVERTS

Whistles / vertical culverts less than 2 feet (0.6 meters) in depth are not considered a confined space.

3.3.6 SMALL PIPING

Any piping with a diameter small enough that a person cannot bodily enter does not meet the definition of a confined space.

3.3.7 EXTERNAL FLOATING TANK ROOFS

Entries onto tank roofs may change in classification depending on the hazards. There are work task activities that do not pose the hazard of actual or potential hazardous atmospheres when appropriate controls are in place. Examples of this would include work on the tops of open floating roofs of tanks that do not include exposure to fresh or new product and does not have the potential to change the atmosphere due to the work activity (e.g. removing the plug from a roof drain, visual inspection of components, cold work, etc.). Tasks that allow exposure to product or cause changes to atmosphere must be treated as a permit required confined space entry (e.g. pulling back the secondary seal, opening a vacuum breaker, etc.).

When performing an alternate entry, employees should still consider other hazards such as slippery walking surfaces, ice and wind when planning work.

Controls for actual or potential atmosphere may be controlled through items that include, but are not limited to:

- Tank roof is static. The product and atmospheric conditions (e.g. wind, temperature, etc.) of the tank will need to be considered to determine if the atmospheric conditions have stabilized and the tank is safe for entry. The tank atmosphere will be confirmed with a monitor with appropriate PPE as required in the alternate procedures section.
- The CCO is contacted
- Tank is isolated
- Tank does not have any known seal leaks
- Tank does not have any open vacuum breakers
- Tank roof does not have any new visible product on it
- Tank is at a high enough level to have natural ventilation (e.g., no vertical ladders)

In the event a tank roof entry does not have an actual or potential hazardous atmosphere, and the work activity being performed will not change the classification, the space may meet the definition of a non-permit required confined space. In the event a tank roof meets these criteria, alternate entry requirements will be used in lieu of non-permit confined space entry requirements. Mechanical ventilation would not be required for this work activity if data shows there is not a hazardous atmosphere and the potential has been removed through appropriate controls.

3.4 CONFINED SPACE ENTRY PLAN

Before contractors are permitted to enter a confined space, the work group that is responsible for or conducts confined space operations must prepare and implement a written confined space entry plan which includes at a minimum:

- Information on the confined space (e.g., dimensions, hazards, controls, ventilation)
- Identification of work activity
- Verification of lockout and isolation if applicable
- Ventilation calculations if applicable
- Communication process (e.g., constant communication with authorized entrants, emergency warning system)
- Identify roles and responsibilities
- Required PPE, including the use of lifelines
- Rescue equipment
- Lockout and isolation, coordination of work activities.

3.5 PRE ENTRY MEETING

The Entry Supervisor will conduct a pre entry meeting prior to entry with all involved workers as applicable:

- Worker(s) entering space
- Confined space attendant personnel
- Rescue personnel at a minimum when working in a permit required confined space
- Permit Issuer
- Site or Worker Supervisor(s) that may direct the work of any of the above

The pre entry meeting will cover the following before confined space entry as applicable:

- The confined space entry permit requirements
- Established procedures

- Air testing procedures
- Method of recording testing results
- Communication system
- Isolation of energy sources and control of materials movement
- Required PPE/respiratory protection equipment
- Securing the confined space from unauthorized entry
- Emergency equipment and required inspection of the equipment
- Ventilation requirements

In the event personnel are added to the Entry Team that did not attend the pre-entry team meeting, the Entry Supervisor must review the contents of the meeting with this person and be satisfied they are fully briefed on their role and responsibilities in the entry activities.

The Entry Team should engage in cursory review of the contents of the Confined Space Package, with a primary focus on:

- Ensuring the stipulations set out in the confined space entry plan have been or will be met prior to entry, including:
 - Pre-initial entry preparations such as isolation, lock out / tag out, and any cleaning, purging, or ventilation activities.
 - Controls to be applied during entry or work within the space.
- Ensuring familiarity with the procedure for initial and any subsequent entry under review.
- Review of the Rescue Plan and ensuring all members are clear on their roles.

All stipulated pre-entry preparation activities must be complete and verified prior to entry.

For subsequent entries to conduct tasks within confined spaces, the size, scope, and necessity of an Entry Team meeting needs to be based on:

- The level of hazards within the space and introduced by the tasks to be conducted.
- The existing familiarity of entrants, confined space attendant, rescue, Entry Supervisor with the confined space and its hazards (e.g., are the same personnel involved as those attending the pre entry meeting?).
- At minimum, prior to any entry to complete a task, the Entry Supervisor must go over the confined space entry plan for the task at hand with the Entrants as part of the Safe Work Permit process (in lieu of a full Entry Team meeting).

3.6 CONFINED SPACE ENTRY PERMIT

A worker shall not enter a permit required confined space without a valid confined space entry permit. Any site emergency, or if the criteria for entry to be terminated is met, shall force the stoppage of all work and will require a new permit to be authorized. The following requirements apply to the confined space entry permit:

- The permit is issued and authorized by permit issuer
- The permit is received by a qualified worker who is involved in the confined space entry
- The permit is approved by a qualified Company representative when a contractor is performing entry
- The permit must be signed by the issuer, receiver, and approver (if applicable)
- The permit cannot be issued until all required fields are completed, and all hazards have been identified and controlled
- If there are changes in the field, the permit will be revised and discussed with impacted parties
- Permits are valid for 12 hours or until the end of the shift, unless there is an approved extension. May be extended if:
 - The same authorized entrant is involved in the work
 - The extension is identified and authorized on the permit
 - A review of the permit confirms it is still valid

The permit must identify conditions to terminate entry.

The permit will be maintained / posted outside of the confined space with supporting documents as applicable.

A single permit may be utilized for multiple spaces when the hazards of the space and the work to be performed are similar.

In the event that an entry has been terminated (due to atmosphere or other unanticipated or unidentified conditions or hazards) , this includes the permit being terminated, no entry will occur until the confined space hazard assessment is completed and / or updated and the space is deemed safe for entry.

3.6.1 CONFINED SPACE PERMIT ROLES

Confined Space Permit Issuer shall:

- Determine Confined Space Classification
- Review hazards and controls with the Permit Receiver

- Verify compliance with the requirements on the Confined Space Entry Permit
- Verify that appropriate controls are in place
- Ensure Initial Atmospheric Monitoring is complete
- Ensure all confined space entry and regulatory requirements are met prior to issuing the confined space entry permit
- Terminate the confined space entry and permit if conditions warrant termination

*Note: This role is typically completed by the Entry Supervisor. The role can be filled by a qualified Company representative or contractor employee.

Confined Space Entry Permit Approver shall:

- Acknowledging the work
- Review Hazards and controls with the Permit Issuer
- Ensure the Confined Space Entry Permit Issuer is aware of site-specific information

Note: This role is intended for approval of contractor entries and is not required for employee entries. A Company representative (e.g. Inspector) will fill this role for entries by contractors hired by other business units (eg. LP Projects & Programs).

Confined Space Entry Permit Receiver shall:

- Provide the Permit Issuer with adequate notice of intended entry
- Provide a sufficient description of the scope of work
- Review hazards and controls with Workers involved in the work
- Ensure requirements on the permit are followed
- Attend and participate in the pre-entry meeting
- Review hazards and control with permit issuer

Note: This role can be either an Company representative or contractor who is involved with the entry to be performed.

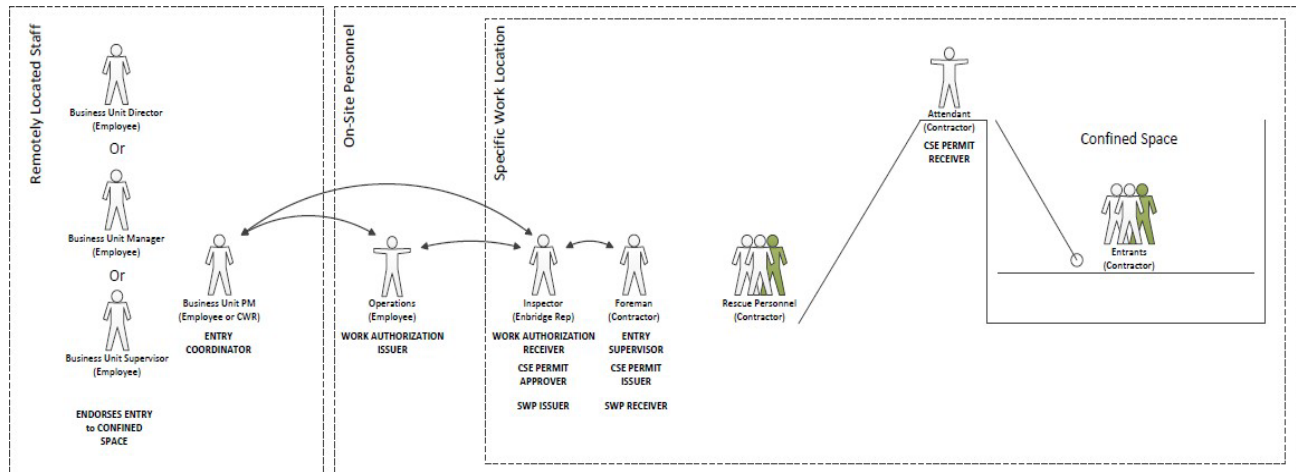

Contractor Entry by Non-Operations Business Unit

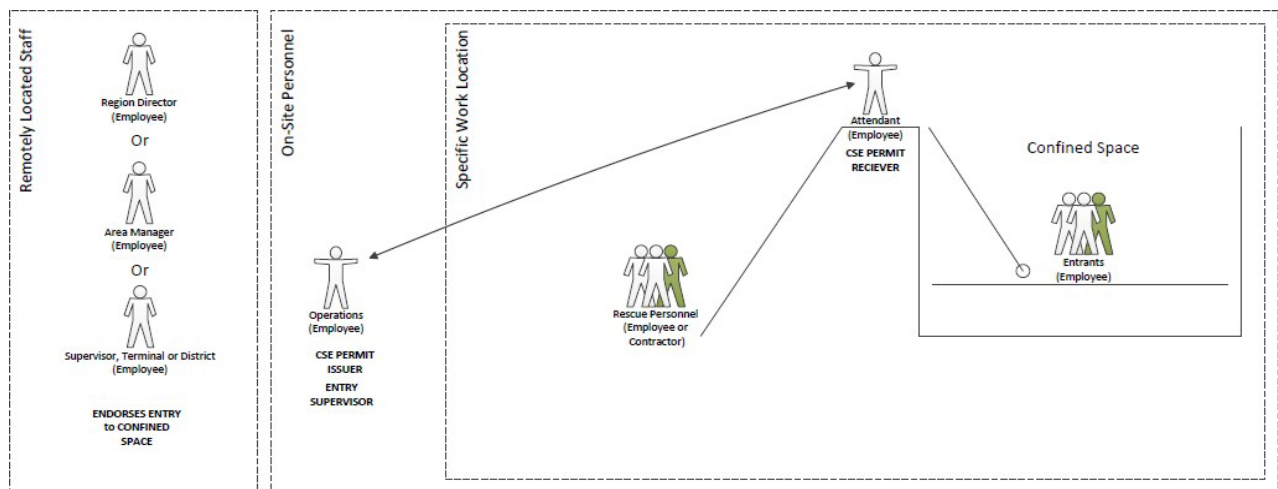

Employee Entry by Operations

3.6.2 TERMINATING AN ENTRY

If atmospheric monitoring indicates that unplanned or unexplained changes have occurred in the confined space all work shall stop and workers will evacuate the confined space. The hazard assessment shall be reviewed if an entry has been terminated and updated as required.

The Entry Supervisor will document on the confined space permit atmospheric conditions of when a confined space entry will be terminated.

If the acceptable criteria cannot be maintained, the typical conditions to terminate an entry may include:

- Oxygen levels that are below 19.5%, or above 23.5%
- LEL of greater than 10% when conducting hot work
- LEL of greater than 20%
- When any contaminant is above the action level per legislative requirements
- Any injury
- Any abnormal operation
- Change to the scope of work
- Site emergency
- If requested to stop work

The time of termination shall be documented on the Confined Space Permit, as the case may be, by the Receiver. Suspended permits shall be revalidated, at a minimum, verbally by the Issuer and documented on the Confined Space Permit before work can resume.

Suspensions due to scope of work changes cannot be revalidated. A new Confined Space Permit is required.

3.6.3 PERMIT DOCUMENT COPIES

White/top copy: Permit Receiver keeps or posts this copy at the work location while the permit is valid. Permit Receiver returns this copy and other pertinent documentation to the Permit Issuer when the Permit time period has expired.

If an Incident occurs during the course of work, the white copy of the Permit along with all other documentation shall be forwarded to the person responsible for conducting the incident investigation and will be retained as identified in the requirements for incident investigation documentation.

Yellow copy: Permit Issuer maintains this copy to identify work activities occurring at the site. Discard after the white copy is returned.

In compliance with the Company's Records Management Policy and Records Retention Schedule, Company representatives must retain all Permits and any related documents or records. All required documentation applicable to Confined Space entry is developed, completed and maintained, in accordance with Company requirements and Applicable Legislation.

Contractors shall have a records retention policy to ensure that all documents or records used, prepared or produced by the contractor in the performance of the work are maintained by the contractor for durations of time that are not less than the limitation periods prescribed in the applicable statutes of limitations or limitation of actions legislation in force in the jurisdictions the contractor operates.

3.7 WORK PRACTICES

3.7.1 PREVENTING UNAUTHORIZED ENTRY

Confined spaces must be:

- Secured against entry (e.g., bolted shut or locked), or
- Identified by a sign that states “Danger, Confined Space, Entry by Permit Only or a sign that uses similar wording at the entry point to indicate that this is a Confined Space and that entry is not permitted without a permit.
- When there is a confined space attendant present at an open confined space, the attendant must ensure all entrants are authorized for entry into the confined space.

Signage that has been removed to allow entry into the confined space shall be replaced when the space has been left unoccupied, this include breaks and shift change.

3.7.2 ATMOSPHERIC TESTING/MONITORING

Refer to the Atmospheric Monitoring and Respiratory Protection Specifications for additional information on confined space atmospheric monitoring and sampling.

Atmospheric monitoring for hazards shall:

- Be conducted by a qualified person using calibrated test instruments that are appropriate for the atmosphere being tested and used in accordance with manufacturers’ specifications
- Be completed in accordance with the requirements identified on the hazard assessment
- Be performed in a manner that does not endanger the health or safety of the worker performing the test
- Be performed in the following order:
 1. Oxygen content (% O₂)
 2. Flammable gases/vapors (% LEL)
 3. Toxic air contaminants (e.g., H₂S)
 4. Other toxic contaminants associated with the work environment, work activity and related job tasks (e.g., CO, Benzene)

Initial Atmospheric Monitoring

Initial atmospheric monitoring is required prior to entry into any confined space, and before a worker re-enters a confined space that has been unoccupied for any length of time. Initial testing must be performed no more than 20 minutes prior to an entry. Atmospheric testing must be repeated within 20 minutes of entry if a confined space is vacated for more than 20 minutes.

Initial monitoring shall be completed from outside the space utilizing remote gas detector accessories and equipment such as sample draw pumps and wands whenever possible. Testing from outside the confined space is not considered entry and does not require a permit. If initial atmospheric monitoring cannot be completed from outside the confined space, conduct initial testing under the respiratory protection level based on the conditions at the time. If this cannot be determined or adequately assessed, wear SCBA / SABA respiratory protection.

Large spaces that are difficult to assess from outside the space can be assessed gradually. If the levels are below hazardous at the entrance, the individual performing the testing can then proceed further into the space. This would continue until a hazardous atmosphere is detected or the space has been fully evaluated. If a hazardous atmosphere is detected, the individual performing the testing will exit the space and discuss entry options with the Entry Supervisor.

If a space has or has the potential for an IDLH atmosphere, a rescue team must be in place prior to the initial atmospheric monitoring being completed (e.g. testing in a tank roof pontoon).

Complete atmospheric monitoring at various locations and elevations of the space whenever possible. Refer to the Atmospheric Testing Specification and the manufacturer's recommendations when performing atmospheric monitoring. Also, consider the response times, length of hose, attachments, functionality of monitor etc.

Continuous/Periodic Monitoring

Continuous atmospheric monitoring for the following is required anytime a worker is in a confined space:

- Oxygen (% O₂)
- Lower explosive limit (% LEL)
- Hydrogen sulfide (H₂S)
- Carbon monoxide (CO)

Levels are documented on the confined space entry permit at a frequency determined by the Entry Supervisor.

Periodic atmospheric monitoring and atmospheric sampling may be required for other hazards or contaminants (e.g. benzene). These frequencies shall be determined by the Entry Supervisor and documented on the confined space entry permit. Frequency for testing may vary from minutes to hours, depending on the hazards of the space.

The use of a Personal Monitor when working in a confined space shall be in accordance with the requirements of the Atmospheric Monitoring Specification.

3.7.3 IDLH ATMOSPHERE

Planned work shall not take place in IDLH environments. If an IDLH environment exists, or has potential to exist, then work shall stop until controls are in place to eliminate, control or minimize the hazards to an acceptable level.

3.7.4 INERTING

A confined space may be inerted if it is not reasonably practicable to eliminate an explosive or flammable atmosphere through other means. Inerted confined spaces will be treated as permit required (high hazard) due to the removal of oxygen. If a confined space is inerted, ensure that:

- Every worker entering the confined space is equipped with SCBA / SABA respiratory protection equipment until oxygen levels have returned to normal.
- All ignition sources are controlled
- The atmosphere within the confined space stays inerted while workers are inside.

*Note: notification to regulatory bodies may be required when placing workers in an inert atmosphere per local legislative requirements

3.7.5 VENTILATION REQUIREMENTS

If atmospheric hazards exist or are likely to exist in a confined space, the confined space shall be purged or ventilated, or both, before any worker enters the space. Acceptable atmospheric levels, as identified on the confined space entry permit, shall be maintained at all times when worker(s) are present in a confined space.

Ventilation requirements shall be determined prior to the entry of the confined space, or utilized if levels are not acceptable. If testing indicates that the confined space's atmosphere is explosive, or if assessment determines that an explosive atmosphere is likely to develop, then purging of the space with an inert gas shall be performed prior to ventilation. Using air movers as a means of ventilation may create a hazardous, explosive atmosphere, due to the addition of oxygen into the confined space.

If ventilation and/or purging are not practical to maintain acceptable atmospheric levels in a confined space, the workers involved shall wear respiratory protection equipment in accordance with the Respiratory Protection Specification.

If mechanical ventilation is required to maintain a safe atmosphere in a confined space, the ventilation equipment shall be equipped with an alarm that will be activated automatically if the equipment fails. An adequate warning system of ventilation failure shall be in place, to ensure each worker receives each warning and is able to exit the confined space safely.

The mechanical ventilation equipment shall be audible or visible to every worker in the confined space, or monitored by a worker who is in constant attendance at the equipment and who is in communication with the authorized entrants. Should the ventilation equipment fail to operate properly, this worker shall immediately direct the authorized entrants to evacuate.

Air volume for confined spaces shall meet the following criteria, if applicable:

- Minimum volume of 1.9 m³/s of air passes through the active working area; or
- Air in the confined space contains at least 19.5% oxygen by volume, LEL is below 10%, and the concentration of each hazardous substance or contaminant(s) present in the space's atmosphere is below acceptable criteria outlined in the permit (below all exposure limits in most cases); or
- The confined space has an air exchange rate of at least 8 times/hour; or
- Per a consensus standard accepted by industry (e.g., API, ANSI, CEPA)

Proper set-up of a ventilation system for a confined space is critical to ensure its effectiveness and to minimize/control hazards and exposures. Consider the following:

- Eliminate "short-circuiting" of airflow around the fans or blowers by using an adaptor plate to bolt the fan to the flange of a man-way, or use any other safely feasible measure.
- Supply air needs to be ducted/hosed to deliver it to the work zone and exhaust air needs to be able to capture any contaminants that may be generated by work activities. The exhaust hood or duct should be placed 300 mm (1 ft.) from the source of the contaminant(s).
- A combination of pushing air in and pulling air out of the confined space is often the most effective. If a contaminant is heavier than air (e.g., crude oil vapors), the ventilation strategy should be to push air in from the top and channel exhaust air out from the bottom. However, if the contaminant is lighter than air (e.g., methane), the contaminant has a tendency to rise to the top of the space; thus, the ventilation strategy should be to push air in from the bottom and pull air out from the top.
- Ventilation should be continuous, where possible, if the source(s) of the hazardous atmosphere still exists, or if operations in the confined space generate contaminants or hazards that create a hazardous atmosphere.
- When a confined space has only a single man-way or opening, or has interior obstructions that decrease the effectiveness of dilution ventilation; local exhaust ventilation with a capture hood/duct placed at the source of contaminants is recommended.
- Confined spaces containing flammable gases or vapors may need to be purged with an inert gas prior to ventilating with air. If inert gases (e.g. nitrogen, argon, carbon dioxide) are used for inerting the confined space, the space shall be well-ventilated after the inerting is completed. Then the atmosphere shall be re-tested before any authorized entrant enters the space.

- Where flammable or combustible gases may be present, the ventilation equipment used shall be designed for use in such environments. The equipment shall also be properly grounded and bonded to prevent static electricity from potentially igniting a combustible source.
- Ensure venting activities do not create another hazard. For example, scrubbers may be applied to the venting exhaust to prevent buildup of contaminant in another location.
- If the location has an air permit, the release of emissions must not violate air permitting requirements. Refer to the Company Environment Department for further clarification.
- Ensure the make-up (fresh) air for the confined space is free of contaminants. Note that make-up air could be contaminated by:
 - Exhaust air that carries contaminants from work that is carried out within the confined space
 - Exhaust from nearby or adjacent fuel-operated equipment, such as generators, air compressors, vacuum trucks, or other vehicles
 - Vapors or substances arising from nearby or adjacent operations and processes, e.g., organic vapors from painting, silica from blasting operations, or lead from paint removal work

3.7.6 HOT WORK

Unless a qualified person has determined that work can be performed safely, hot work shall not be performed in a confined space that contains:

- an explosive or flammable hazardous substance in a concentration in excess of 10% of its lower explosive limit; or
- oxygen in a concentration in excess of 23.5%

If these conditions are exceeded during hot work activities, the hot work shall stop and remain stopped until the conditions are deemed safe for work to continue. This determination shall be based on additional or subsequent air testing.

When performing hot work activities, a qualified fire watch person shall patrol the area surrounding the confined space until all fire hazards have passed per the Hot Work and Ignition Sources Specification. Appropriately rated fire extinguishers are required in the immediate area per the Emergency Preparedness Specification.

3.7.7 ISOLATION REQUIREMENTS

Refer to the Control of Hazardous Energy Specification for additional information on isolation and control of energy. Each worker entering a confined space shall be adequately protected against isolation related hazards, as follows:

- Protect workers from the release of hazardous substances in the confined space by disconnecting, blanking, blinding or double block and bleed of piping, cribbing etc.
- Protect workers from contact with electrical energy inside the confined space by disconnecting, de-energizing, lockout and tagging the source of electrical energy.
- Protect workers from moving parts of equipment inside the confined space by disconnecting the equipment from its power source, de-energizing the equipment, ensuring there is no stored energy, locking and tagging all energy sources.
- Other adequate means of worker protection and hazard prevention are required if the above controls are not possible.

3.8 CONFINED SPACE RESCUE

The rescue requirements for each permit-required confined space will vary based on the unique hazards identified. Every permit-required confined space entry requires:

- The services of one or more rescue personnel
- A documented Rescue Plan
- Personnel assigned rescue duties must be notified before workers enter a confined space and when all workers have exited from the space.
- If multiple confined spaces are being entered, notifying rescue personnel to be onsite in an alert status, unless the confined space(s) pose a risk of IDLH Atmosphere.
- In cases where there is a contract for rescue personnel to provide 24-hour service individual notification may not be required.
- Assigned rescue personnel must monitor any signaling system used to summon them while a confined space entry is underway or while on an alert status.
- Where an entry-rescue into IDLH atmosphere is a possible rescue scenario, the rescue team must remain at the confined space during the entry itself. The rescue team must have PPE donned, including SCBA or SABA with an escape bottle, and respirator masks at the ready.
- Where an entry-rescue into an actual or potential IDLH atmosphere is a possible rescue scenario, the rescue team must identify an appropriate number of responders based on OSHA requirements for IDLH atmospheres in Confined Space and Respiratory Protection Specification.
- A rescue worker may not enter the confined space unless there is at least one additional worker located outside to render assistance.
- The confined space attendant may serve as a rescue worker and may perform a non- entry rescue using an attached lifeline.

- In the event rescuing an entrant involves physically entering the confined space, a rescue worker in addition to an existing confined space attendant will be required to execute a rescue (i.e., one person enters to extract the entrant, the other remains outside to render assistance).
- Once rescue is initiated, the leader on the scene is either (a) an Entry Supervisor with knowledge of the rescue procedure or (b) a qualified rescue worker.
- The most senior person present, not directly involved in the rescue shall trigger the site-specific Emergency Response Plan.
- The qualified confined space rescue team retains control over the rescue itself until the entrant is extracted.
- Rescue personnel must wear SCBA or SABA with an escape bottle in any rescue within a confined space with an unknown or IDLH atmosphere.
- Workers entering a space assessed as a “High Hazard Atmosphere” must wear a safety harness securely attached to a lifeline.
- The lifeline must be securely anchored outside the confined space.
- The confined space attendant is responsible to assist in ensuring the lifeline does not become entangled during entry and work inside.
- The confined space attendant must be able to extract the worker(s) without entering the space using the lifeline in an emergency and must be supplied with a mechanic device as required to facilitate this type of rescue.
- This requirement does not apply if the lifeline itself creates a hazard or extraction with the lifeline would be impossible due to the configuration of the space.
- Frequency and requirements to complete drills as outlined by Regulatory Requirements.

3.8.1 THIRD PARTY RESCUE TEAMS

When utilizing a third party rescue team, the following requirements will apply:

Evaluation

An evaluation of the rescue team must be completed by the hiring Company business unit a minimum of once per a calendar year. This information only needs to be completed by one Company business unit/Region and then can be shared with other units/Regions utilizing the same vendor. Information reviewed will include at a minimum:

- Incident deployment history
- Type of work provided

- Availability and staffing
- Training records
- Equipment inventory
- Equipment maintenance and inspection procedures

Coordination of Work

The hiring Company business unit must provide the rescue team with access to all spaces from which rescue may be necessary. This is to facilitate that the rescue service can develop appropriate rescue plans and practice rescue operations.

Equipment

The selection of equipment must be appropriate for the confined space. All rescue equipment must be appropriately rated for its use (recommended utilizing equipment rated as NFPA 1983). Equipment must have inspections documented and available for review.

Rescue Plan

The confined space rescue team will be required to develop and submit for review a rescue plan for the work being completed, consistent with 3.8.2.

If an area is utilizing a fire department in any capacity for a confined space rescue, it must be confirmed that the fire department has the ability and appropriate equipment to assist. The requirements for third party rescue apply in an application where a fire department will be utilized. The fire department will also be granted access on a regular basis to review and evaluate spaces.

3.8.2 RESCUE PLAN

Confined spaces classified as permit required must have a formal rescue plan developed prior to space entry and maintained with other confined space entry documents. This plan should be read and reviewed prior to initial entry by the Entry Team to:

- Ensure familiarity with the plan for all participants (entrants, confined space attendant, and rescue team) with the plan.
- Determine if any additional rescue provisions need to be prepared.

*Note: A single rescue plan may be applicable to several confined spaces that share similar characteristics and hazards.

The Rescue Plan must include at a minimum:

- Information on the confined space

- Hazards – Potential and Actual
- Controls
- Site Layout
- Equipment necessary to complete a rescue
- Methodology of rescue
- Names of individuals that will be onsite performing the rescue
- Role each team member will perform in a rescue situation
- Contact information
- Communication methodology
- Medical equipment necessary to be on site
- PPE requirements

3.9 CONFINED SPACE CLOSURE REQUIREMENTS

Once work is completed within a confined space, prior to final closure of the space, the following should be done:

- Final visual inspections to ensure no personnel are inside the space prior to closure.
- Ensure any active Permit is formally closed with required sign-offs complete.

3.10 CONFINED SPACE PACKAGE

When a contractor will be conducting confined space entries, this package will be provided to them from a Company representative, all relevant documentation will be compiled and available prior to entry into a confined space. This Confined Space Package should include (as applicable):

- Worksite specific Confined Space Entry requirements
- Any specific identified Hazards as well as experience with the space, such as knowledge of hazardous conditions
- Applicable Safety Data Sheets
- Confined Space Permit
- Hazard Assessment
- Piping and Instrumentation Diagrams (P&IDs)
- Isolation drawings (identify isolation points, line breaks and blind locations)
- LOTO form(s)

-
- Procedures for tasks to be conducted in Confined Space

4.0 REFERENCES

OSHA 29 CFR 1910.146

5.0 APPENDIX

5.1 IDENTIFICATION OF A CONFINED SPACE

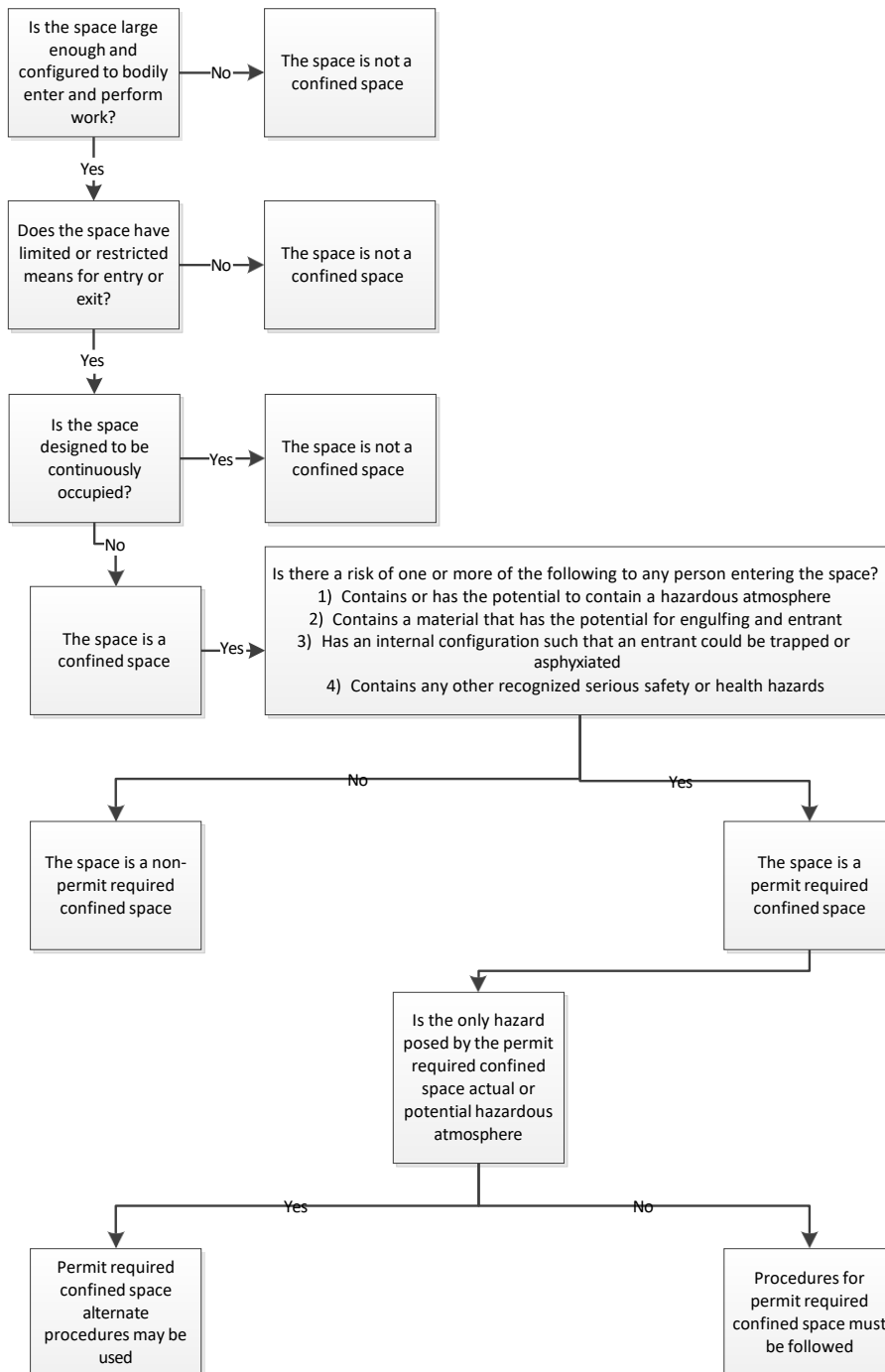

5.2 CONFINED SPACE ENTRY PERMIT

CONFINED SPACE ENTRY PERMIT – US
000000

Part 1: Description	Date Permit Issued: _____ Contractor: _____ Site: _____ Time Permit issued: _____ Time Permit Expires (12 hour max without extension): _____ Time Work Completed: _____ Emergency Response Contact Info (e.g. phone #, radio channel): _____ Location of Confined Space to be Entered: _____ SWP #: _____ is there an Isolation LOTO Form: <input type="checkbox"/> Yes <input type="checkbox"/> No If yes, attach. Other: _____																		
Part 2: Confined Space Entry Checklist	<table border="1" style="width: 100%; border-collapse: collapse;"> <tr> <td style="width: 33%; padding: 2px;"> Type of Work: <input type="checkbox"/> Cold <input type="checkbox"/> Hot <input type="checkbox"/> Electrical – line side of 480v/500v main breaker (clearance/isolation form required) </td> <td style="width: 33%; padding: 2px;"> Work Environment: <input type="checkbox"/> Hazardous Area <input type="checkbox"/> Restricted Area <input type="checkbox"/> Unclassified </td> <td style="width: 33%; padding: 2px;"> Confined Space Class: <input type="checkbox"/> Permit Required Confined Space <input type="checkbox"/> Alternative Entry </td> </tr> </table> Description of Work: _____ _____ _____	Type of Work: <input type="checkbox"/> Cold <input type="checkbox"/> Hot <input type="checkbox"/> Electrical – line side of 480v/500v main breaker (clearance/isolation form required)	Work Environment: <input type="checkbox"/> Hazardous Area <input type="checkbox"/> Restricted Area <input type="checkbox"/> Unclassified	Confined Space Class: <input type="checkbox"/> Permit Required Confined Space <input type="checkbox"/> Alternative Entry															
Type of Work: <input type="checkbox"/> Cold <input type="checkbox"/> Hot <input type="checkbox"/> Electrical – line side of 480v/500v main breaker (clearance/isolation form required)	Work Environment: <input type="checkbox"/> Hazardous Area <input type="checkbox"/> Restricted Area <input type="checkbox"/> Unclassified	Confined Space Class: <input type="checkbox"/> Permit Required Confined Space <input type="checkbox"/> Alternative Entry																	
Part 3: Air Testing Requirements	<table style="width: 100%;"> <tr> <td style="width: 50%; vertical-align: top;"> <ul style="list-style-type: none"> • Has the confined space location, hazards, and their controls, been reviewed and the confined space to be entered confirmed? <input type="checkbox"/> Yes <input type="checkbox"/> No • Has the hazard assessment been attached to the Permit? <input type="checkbox"/> Yes <input type="checkbox"/> No • Have all specific job responsibilities been assigned? (Indicate person responsible): Entry Supervisor – _____ Equipment Lockout – _____ Attendant – _____ Atmospheric Testing – _____ Preparation requirements completed prior to entry (cleaning, purging, venting, inerting, etc.): _____ _____ _____ </td> <td style="width: 50%; vertical-align: top;"> <ul style="list-style-type: none"> • Have all entry points into the confined space been identified and properly secured against unauthorized entry? <input type="checkbox"/> Yes <input type="checkbox"/> No • Is required monitoring equipment available and calibrated? <input type="checkbox"/> Yes <input type="checkbox"/> No • Is required rescue equipment available? <input type="checkbox"/> Yes <input type="checkbox"/> No • Do all personnel have required training? (Including those not entering confined space) <input type="checkbox"/> Yes <input type="checkbox"/> No • Are all pertinent SDS available and have they been reviewed? <input type="checkbox"/> Yes <input type="checkbox"/> No • Are there any ventilation / equipment required? (i.e. air movers, nitrogen purge, etc.) <input type="checkbox"/> Yes <input type="checkbox"/> No • Have lockout and isolation points been verified and tested? <input type="checkbox"/> Yes <input type="checkbox"/> No • Have all required information and materials been provided to the contractor performing the confined space entry (if applicable)? <input type="checkbox"/> Yes <input type="checkbox"/> No Attachments: <input type="checkbox"/> Hazard Assessment <input type="checkbox"/> Rescue Plan <input type="checkbox"/> SDS <input type="checkbox"/> Ventilation Plan (as required) <input type="checkbox"/> Other _____ </td> </tr> </table> Conditions Under Which Entry is to be Terminated: _____ _____	<ul style="list-style-type: none"> • Has the confined space location, hazards, and their controls, been reviewed and the confined space to be entered confirmed? <input type="checkbox"/> Yes <input type="checkbox"/> No • Has the hazard assessment been attached to the Permit? <input type="checkbox"/> Yes <input type="checkbox"/> No • Have all specific job responsibilities been assigned? (Indicate person responsible): Entry Supervisor – _____ Equipment Lockout – _____ Attendant – _____ Atmospheric Testing – _____ Preparation requirements completed prior to entry (cleaning, purging, venting, inerting, etc.): _____ _____ _____	<ul style="list-style-type: none"> • Have all entry points into the confined space been identified and properly secured against unauthorized entry? <input type="checkbox"/> Yes <input type="checkbox"/> No • Is required monitoring equipment available and calibrated? <input type="checkbox"/> Yes <input type="checkbox"/> No • Is required rescue equipment available? <input type="checkbox"/> Yes <input type="checkbox"/> No • Do all personnel have required training? (Including those not entering confined space) <input type="checkbox"/> Yes <input type="checkbox"/> No • Are all pertinent SDS available and have they been reviewed? <input type="checkbox"/> Yes <input type="checkbox"/> No • Are there any ventilation / equipment required? (i.e. air movers, nitrogen purge, etc.) <input type="checkbox"/> Yes <input type="checkbox"/> No • Have lockout and isolation points been verified and tested? <input type="checkbox"/> Yes <input type="checkbox"/> No • Have all required information and materials been provided to the contractor performing the confined space entry (if applicable)? <input type="checkbox"/> Yes <input type="checkbox"/> No Attachments: <input type="checkbox"/> Hazard Assessment <input type="checkbox"/> Rescue Plan <input type="checkbox"/> SDS <input type="checkbox"/> Ventilation Plan (as required) <input type="checkbox"/> Other _____																
<ul style="list-style-type: none"> • Has the confined space location, hazards, and their controls, been reviewed and the confined space to be entered confirmed? <input type="checkbox"/> Yes <input type="checkbox"/> No • Has the hazard assessment been attached to the Permit? <input type="checkbox"/> Yes <input type="checkbox"/> No • Have all specific job responsibilities been assigned? (Indicate person responsible): Entry Supervisor – _____ Equipment Lockout – _____ Attendant – _____ Atmospheric Testing – _____ Preparation requirements completed prior to entry (cleaning, purging, venting, inerting, etc.): _____ _____ _____	<ul style="list-style-type: none"> • Have all entry points into the confined space been identified and properly secured against unauthorized entry? <input type="checkbox"/> Yes <input type="checkbox"/> No • Is required monitoring equipment available and calibrated? <input type="checkbox"/> Yes <input type="checkbox"/> No • Is required rescue equipment available? <input type="checkbox"/> Yes <input type="checkbox"/> No • Do all personnel have required training? (Including those not entering confined space) <input type="checkbox"/> Yes <input type="checkbox"/> No • Are all pertinent SDS available and have they been reviewed? <input type="checkbox"/> Yes <input type="checkbox"/> No • Are there any ventilation / equipment required? (i.e. air movers, nitrogen purge, etc.) <input type="checkbox"/> Yes <input type="checkbox"/> No • Have lockout and isolation points been verified and tested? <input type="checkbox"/> Yes <input type="checkbox"/> No • Have all required information and materials been provided to the contractor performing the confined space entry (if applicable)? <input type="checkbox"/> Yes <input type="checkbox"/> No Attachments: <input type="checkbox"/> Hazard Assessment <input type="checkbox"/> Rescue Plan <input type="checkbox"/> SDS <input type="checkbox"/> Ventilation Plan (as required) <input type="checkbox"/> Other _____																		
Part 4: Onsite Evacuation & Rescue	Tester's Name: _____ Testing Equipment/ Methods: _____ Calibration Date: _____ Bump Date: _____ Frequency of Atmospheric Testing (results must be recorded at the interval): _____ Personal Monitors Required for Entrants? <input type="checkbox"/> Yes <input type="checkbox"/> No <input type="checkbox"/> Continuous for O ₂ , LEL, H ₂ S, CO (mandatory) <input type="checkbox"/> Other toxins to be tested: _____ Frequency of testing: _____ _____ Frequency of testing: _____ _____ Frequency of testing: _____ Acceptable atmospheric levels for this space (O ₂ , LEL, H ₂ S, CO, benzene, etc): _____ _____ _____ Reminder: Tests shall be performed and recorded before a worker enters or re-enters the space. Initial testing must be performed no more than 20 minutes prior to an entry. Atmospheric testing must be repeated within 20 minutes of entry if a confined space is vacated for more than 20 minutes.																		
Part 5: Approvals	<table style="width: 100%;"> <tr> <td style="width: 50%; vertical-align: top;"> <ul style="list-style-type: none"> Are we using an internal Enbridge team for rescue? <input type="checkbox"/> Yes <input type="checkbox"/> No External Third Party Rescue: <input type="checkbox"/> Yes <input type="checkbox"/> No If yes, name of external vendor: _____ How is the rescue team summoned or communicated with (cellphone / radio, etc.): _____ Equipment required for rescue: _____ Nearest Medical Facility: _____ Names of Rescue Team Members: _____ For permit required confined spaces, please attach the Rescue Plan. </td> <td style="width: 50%; vertical-align: top;"> <table border="1" style="width: 100%; border-collapse: collapse;"> <thead> <tr> <th style="text-align: left;">Initial Air Test</th> <th style="text-align: left;">Results</th> </tr> </thead> <tbody> <tr><td>O₂</td><td>_____</td></tr> <tr><td>LEL</td><td>_____</td></tr> <tr><td>H₂S</td><td>_____</td></tr> <tr><td>CO</td><td>_____</td></tr> <tr><td>Benzene</td><td>_____</td></tr> <tr><td>Other</td><td>_____</td></tr> <tr><td>Tester's Initials:</td><td>_____</td></tr> </tbody> </table> </td> </tr> </table>	<ul style="list-style-type: none"> Are we using an internal Enbridge team for rescue? <input type="checkbox"/> Yes <input type="checkbox"/> No External Third Party Rescue: <input type="checkbox"/> Yes <input type="checkbox"/> No If yes, name of external vendor: _____ How is the rescue team summoned or communicated with (cellphone / radio, etc.): _____ Equipment required for rescue: _____ Nearest Medical Facility: _____ Names of Rescue Team Members: _____ For permit required confined spaces, please attach the Rescue Plan.	<table border="1" style="width: 100%; border-collapse: collapse;"> <thead> <tr> <th style="text-align: left;">Initial Air Test</th> <th style="text-align: left;">Results</th> </tr> </thead> <tbody> <tr><td>O₂</td><td>_____</td></tr> <tr><td>LEL</td><td>_____</td></tr> <tr><td>H₂S</td><td>_____</td></tr> <tr><td>CO</td><td>_____</td></tr> <tr><td>Benzene</td><td>_____</td></tr> <tr><td>Other</td><td>_____</td></tr> <tr><td>Tester's Initials:</td><td>_____</td></tr> </tbody> </table>	Initial Air Test	Results	O ₂	_____	LEL	_____	H ₂ S	_____	CO	_____	Benzene	_____	Other	_____	Tester's Initials:	_____
<ul style="list-style-type: none"> Are we using an internal Enbridge team for rescue? <input type="checkbox"/> Yes <input type="checkbox"/> No External Third Party Rescue: <input type="checkbox"/> Yes <input type="checkbox"/> No If yes, name of external vendor: _____ How is the rescue team summoned or communicated with (cellphone / radio, etc.): _____ Equipment required for rescue: _____ Nearest Medical Facility: _____ Names of Rescue Team Members: _____ For permit required confined spaces, please attach the Rescue Plan.	<table border="1" style="width: 100%; border-collapse: collapse;"> <thead> <tr> <th style="text-align: left;">Initial Air Test</th> <th style="text-align: left;">Results</th> </tr> </thead> <tbody> <tr><td>O₂</td><td>_____</td></tr> <tr><td>LEL</td><td>_____</td></tr> <tr><td>H₂S</td><td>_____</td></tr> <tr><td>CO</td><td>_____</td></tr> <tr><td>Benzene</td><td>_____</td></tr> <tr><td>Other</td><td>_____</td></tr> <tr><td>Tester's Initials:</td><td>_____</td></tr> </tbody> </table>	Initial Air Test	Results	O ₂	_____	LEL	_____	H ₂ S	_____	CO	_____	Benzene	_____	Other	_____	Tester's Initials:	_____		
Initial Air Test	Results																		
O ₂	_____																		
LEL	_____																		
H ₂ S	_____																		
CO	_____																		
Benzene	_____																		
Other	_____																		
Tester's Initials:	_____																		
Part 5: Approvals	<table style="width: 100%;"> <tr> <td style="width: 33%; border-bottom: 1px solid black; padding: 2px;">Permit Issuer/Entry Supervisor:</td> <td style="width: 33%; border-bottom: 1px solid black; padding: 2px;">Permit Approver</td> <td style="width: 33%; border-bottom: 1px solid black; padding: 2px;">Permit Receiver</td> </tr> <tr> <td style="border-bottom: 1px solid black; padding: 2px;">Print Name:</td> <td style="border-bottom: 1px solid black; padding: 2px;">Print Name:</td> <td style="border-bottom: 1px solid black; padding: 2px;">Print Name:</td> </tr> <tr> <td style="border-bottom: 1px solid black; padding: 2px;">Signature:</td> <td style="border-bottom: 1px solid black; padding: 2px;">Signature:</td> <td style="border-bottom: 1px solid black; padding: 2px;">Signature:</td> </tr> </table> By signing this permit, the receiver acknowledges that all safety requirements have been met, have been reviewed with the workers, will be maintained for the duration of the permit and it's safe to proceed with the work. All workers associated with the work must sign in the area provided on the back of the permit during the pre-job entry meeting. Record of Permit Closure: Job Completed? <input type="checkbox"/> Yes <input type="checkbox"/> No Have all personnel vacated the space? <input type="checkbox"/> Yes <input type="checkbox"/> No Have all tools/equipment been removed from the space? <input type="checkbox"/> Yes <input type="checkbox"/> No Permit Extension: Is the planned work expected to exceed 12 hours? <input type="checkbox"/> Yes <input type="checkbox"/> No	Permit Issuer/Entry Supervisor:	Permit Approver	Permit Receiver	Print Name:	Print Name:	Print Name:	Signature:	Signature:	Signature:									
Permit Issuer/Entry Supervisor:	Permit Approver	Permit Receiver																	
Print Name:	Print Name:	Print Name:																	
Signature:	Signature:	Signature:																	

VERSION 1 (March 30, 2019)

Distribution: White – Permit Receiver, Gold – Permit Issuer. Retain white copy



CONFINED SPACE ENTRY PERMIT – US

000000

Part 6: Pre-Entry Meeting:							
Confined Space Entry Supervisor or Designate (print and sign): _____ <small>This signature authorizes the entry of the following workers into the confined space.</small>							
Workers Involved (print and sign)							
1. _____	8. _____	15. _____					
2. _____	9. _____	16. _____					
3. _____	10. _____	17. _____					
4. _____	11. _____	18. _____					
5. _____	12. _____	19. _____					
6. _____	13. _____	20. _____					
7. _____	14. _____	21. _____					
Topics to be reviewed (as applicable):				<input type="checkbox"/> Air Testing Requirements <input type="checkbox"/> Confined Space Attendant Responsibilities <input type="checkbox"/> Ventilation <input type="checkbox"/> Required personal protective and respiratory equipment required for entry <input type="checkbox"/> Entrant tracking requirements (sign in/out with confined space attendant) <input type="checkbox"/> Conditions under which entry is not allowed or must be terminated <input type="checkbox"/> Emergency equipment and inspection of equipment <input type="checkbox"/> Rescue plan			
<input type="checkbox"/> Confined Space Classification <input type="checkbox"/> Confined Space Entry Checklist <input type="checkbox"/> Hazard Assessment and Controls <input type="checkbox"/> Procedures/plans to be followed <input type="checkbox"/> Permit Requirements <input type="checkbox"/> Communication Systems <input type="checkbox"/> Isolation of energy sources and control of materials movement							
Pre-Entry Meeting Notes:							
Part 7: Periodic Atmospheric Testing Results							
Time of Test							
Tester's Name							
Tester's Initials							
O₂							
H₂S							
LEL							
CO							
Benzene							
Other (Specify) _____							
Other (Specify) _____							
Part 8: Entrant Tracking (Completed by the Confined Space Attendant)							
Confined Space Attendant Name:				Confined Space Attendant Signature:			
Entrant Name (First and Last)	Entry Time	Exit Time	Entry Time	Exit Time	Entry Time	Exit Time	Entry Time
1.							
2.							
3.							
4.							
5.							
6.							
7.							
8.							
9.							
10.							
11.							
12.							
13.							
14.							
15.							
16.							
Confined Space Attendant Notes:							
<input type="checkbox"/> Communication system with entrants: _____ <input type="checkbox"/> Communication system with responsible supervisor: _____ <input type="checkbox"/> Communication system with rescue team: _____							

VERSION 1 (March 30, 2019)

Distribution: White – Permit Receiver, Gold – Permit Issuer Retain white copy

5.3 CONFINED SPACE RESCUE PLAN – TEMPLATE

CONFINED SPACE RESCUE PLAN



Name: _____ Job/Task: _____

Confined Space Dimensions: _____ Date: _____

Confined Space Location: _____

Entry and exit points: _____

Number of workers involved in Confined Space Entry work:
Max: ____ Min: _____

#	Equipment List	Entry	Rescue	N/A	Pre-Use Inspection	Location
1.	FR Coveralls, hard hat, safety boots/glasses					
2.	Gloves: Type: _____ per FLHA					
3.	SCBA (Self Contained Breathing Apparatus)					
4.	AP Respirator (1/2, Full); Cartridge Type: _____					
5.	Air Horn/ Mobile Phone/Radio					
6.	First Aid Kit					
7.	Full Body Harnesses					
8.	Monogoggles /Face Shield					
9.	Fire Extinguisher Type: ABC Size: 20lb					
10.	Stretcher/Back Board					
11.	Retrieval system: Rollgliss; Other					
12.						

Rescue Team Members & Response Roles

Confined Space Attendant (Safety Watch) Duties

- Sound alarm; direct everyone to a safe area, contact control room, rescue team, and/or client representative, and assist rescue team.

Name:	Phone Number:

Confined Space Entry Supervisor

- Direct all equipment to be shut down, and leave the area. Assist in the rescue of casualties, if safe to do so, as outlined in the rescue procedure.

Name:	Phone Number:

Rescuers:

- (Rescuers must be notified prior to work starting that they may need to respond, and their duties.)*
- Identify Rescuers for entry; don required PPE/RPE to ensure protection of Rescue Team. Enter the confined space and initiate the rescue/retrieval of victims. Additional personnel to assist as required.
 - Rescuers must be trained in: first aid, CPR, and Confined Space rescue and equipment training

Name	Company / Job Title	Phone Number

Basic & Initial Response Strategy

1.0 Evacuate

- Evacuate out of proximity to safe area and shut off all equipment if safe to do so.

2.0 Alarm

- Sound alarm and the assigned Confined Space Attendant (Safety Watch) will initiate response communication & coordination with client representative / control room.

3.0 Assess the Situation

- When assessing the situation prior to commencing rescue, the following must identified prior to entry and updated at time of entry:

A) Known Hazards:

<ul style="list-style-type: none"> ▪

B) The Possible Injuries that could arise to the Victim(s). Complete before initial entry:

--

4.0 Protect the Rescuer

- The following additional protective equipment shall be worn by the rescuers.

PPE for a Hazardous Atmosphere	PPE for a Non Hazardous Atmosphere

5.0 Rescue Plan

- a) The Rescue Team will don the PPE/RPE noted above for their protection.
- b) Entering/Retrieval Team enter the confined space to retrieve victim(s). While one Rescue Team member and Confined Space Attendant (Safety Watch) remains outside the entry point ready to provide assistance. Identify any obstacles to removing an injured worker
- c) **Retrieval practices of victim(s)** from within this confined space will include the following steps:

1.
2.
3.
4.

6.0 Provide First Aid

If required the assigned first aid shall administer the necessary first aid treatment (this may include providing rescue breathing).

#	NAME of FIRST AIDER	COMPANY/CONTACT NUMBER
1.		
2.		
3.		
4.		

7.0 Transport Victim to get Medical Attention:

Address/phone number of the nearest location for Medical Aid Attention is noted below:

CONTACT:	PHONE NUMBER:
Ambulance:	
Hospital:	
Medical Center:	
STARS	
Stars Location:	
STARS Site ID:	

5.4 CONFINED SPACE ENTRY PLAN – TEMPLATE

CONFINED SPACE ENTRY PLAN



Name: _____ Job/Task: _____

Confined Space Dimensions: _____ Date: _____

Confined Space Location(# and name if applicable): _____

Entry and exit points: _____

Reclassification of a confined space (if applicable):

If a permit required confined space is to be reclassified to a non-permit status, the process will be documented in this section. This plan will be made available to workers at the site to communicate how hazards have been eliminated and/or controlled. This process is to be completed once and remains in effect for the duration of the work as long as the hazards remain eliminated and/or controlled. If a space is reclassified, only this portion of the plan will need to be completed.

- There is not an actual or potential hazardous atmosphere (mechanical ventilation cannot be required to maintain the atmosphere)
- The space does not contain a material that has the potential for engulfing an entrant
- The space does not have an internal configuration such that an entrant could be trapped or asphyxiated
- The space does not contain any other recognized serious safety or health hazards as documented below:

Types of Hazards Eliminated	How Hazard was Eliminated

Permit Required and Alternate Entries into Confined Spaces:

Hazards	Controls

CONFINED SPACE ENTRY PLAN

Roles

Role	Name(s)
Entry Supervisor:	
Attendant:	
Permit Issuer:	
Site or Worker Supervisor:	
Rescue Personnel:	

Number of workers involved in Confined Space Entry work:
Max: ____ Min: ____

Work Activity:

Outline task(s) taking place within the confined space:

Ventilation Calculation

Volume of Space _____ cubic feet X 20 (# of air changes) = _____ minutes
Ventilation device flow rate _____ CFM

Verification of Lockout/ Isolation

All lockout/ tagout completed following the Control of Hazardous Energy Standard

Required Equipment

#	Equipment List	Entry	Rescue	N/A	Location
1.	FR Coveralls, hard hat, safety boots/glasses				
2.	Gloves: Yes Type: Leather per FLHA				
3.	SCBA (Self Contained Breathing Apparatus)				
4.	AP Respirator (1/2, Full); Cartridge Type:				
5.	Air Horn/ Mobile Phone/Radio				
6.	First Aid Kit				
7.	Full Body Harnesses				
8.	Monogoggles /Face Shield				
9.	Fire Extinguisher Type: ABC Size: 20lb				
10.	Stretcher/Back Board				
11.	Retrieval system: Rollgliss; Other				
12.	Lifelines				

CONFINED SPACE ENTRY PLAN

Duties of Entry Participants

<u>Role</u>	<u>Responsibilities</u>	<u>Name or Title</u>
<p><u>Entrants</u> Authorized to enter a permit space and do work</p>	<ul style="list-style-type: none"> • Know the hazards that they may encounter during entry • Properly use equipment • Communicate with attendant as needed alerting of hazards • Exit from permit space whenever ordered to evacuate, a hazard is recognized, or an evacuation alarm is activated 	<p><i>[Click here to enter names or positions.]</i></p>
<p><u>Attendants</u> Stationed outside of a permit space to monitor entrant activity and perform duties listed on the permit</p>	<ul style="list-style-type: none"> • Know the hazards of the space • Know the symptoms of hazard exposure in entrants • Keep track of and record the entrants in the permit space • Remain outside the space during operations until relieved • Monitor the work area for hazardous conditions • Summon rescue and emergency services • Communicate with entrants to relay information and monitor the status of the entrants • Order the evacuation of the entrants from the space if a hazardous condition is encountered • Keep unauthorized employees away from the space • Perform no duties that might interfere with the attendant's primary duty to monitor and protect the entrants • Ensure the space has been completely evacuated in the event of an emergency • Ensure proper signage/ barricades are in place to prevent unauthorized entry 	<p><i>[Click here to enter names or positions.]</i></p>
<p><u>Entry Supervisor</u> Authorize and supervise permit-required confined space entry operations</p>	<ul style="list-style-type: none"> • Conduct the pre-entry meeting • Recognize potential hazards during entry, signs/symptoms of exposure • Before entry, determine that area conditions meet requirements of the permit • Ensure a hazard assessment is completed prior to entry • Provide necessary equipment, hazardous material information, and assuring rescue services are in place • Assure entrants and attendants are trained prior to entry • Determine that entry operations and conditions remain consistent with the terms of the permit • Remove unauthorized individuals from area during entry operations • Cancel the permit at the conclusion of the entry 	<p><i>[Click here to enter names or positions.]</i></p>

CONFINED SPACE ENTRY PLAN



Sample Entry Procedure:

1. Complete Confined Space Entry Plan and a Rescue Plan, if applicable, ensuring all Personnel involved understand their duties and responsibility.
2. Obtain and fully complete a Confined Space Entry Permit
3. Ensure all participants in the entry have been trained. Assign duties to all participants.
4. Ensure Proper PPE, ventilation, air monitoring and rescue equipment needed for entry is available, assembled, and in working order.
5. Determine method of communication between entrants and attendant.
6. Verify all air monitors have been calibrated and are in working order.
7. Call the emergency rescue service to alert them of the planned confined space entry.
8. Eliminate any condition making it unsafe to remove the entrance cover.
9. Post signs, barriers and barrier tape as necessary to stop entry. Provide traffic control if necessary.
10. Before entering, lock and tag out (LOTO) any mechanical hazards, gas, water lines, or electrical power. Try to turn the system on after locking out to ensure that there is no energy available.
11. Set up and check out all rescue equipment (e.g. body harness, lifelines, rollgliss) prior to entry.
12. Conduct atmospheric monitoring in the space to ensure that no atmospheric hazards are present. Monitoring must always be conducted immediately before entering any confined space.
 - If the air quality inside the confined space is safe with no fresh air ventilation, and if the only hazard is an actual or potentially hazardous atmosphere that can be controlled by continuous forced air ventilation, the space may be reclassified temporarily as an "Alternate Entry Procedures" space.
13. Write air monitoring results and time taken on the Permit.
14. If air monitoring results or the work to be done in the space indicates that ventilation is needed, set up the ventilation blower so that it takes in clean, uncontaminated air. Do not place intake next to vehicles, gas-powered equipment, or exhaust vent from a lab or other potentially contaminated work area. Attach ducting to blower, turn on, and place exhaust end well inside confined space. Run the blower for the minimum amount of time needed to purge the space for 20 air changes based on the calculations made on the Permit.
15. After ventilation, check the atmosphere in the space again to confirm that acceptable entry conditions are present.
16. If all entry conditions are met, the entry supervisor signs the permit allowing entry to the space.
17. Entrant ensures appropriate PPE is donned
18. Entrant enters the space and checks for hazards that may not have been detected.
19. Continue to monitor the atmosphere in the space throughout entry and record results at pre-determined frequencies
20. Attendant communicates with entrant for entire entry.
21. **Exit the space immediately if any of the following occurs:**
 - A hazardous atmosphere is detected.
 - Any health or safety hazard is detected.
 - If entrant shows signs of exposure to atmospheric hazards, feels ill, notices strong odors or has other safety concerns.Re-evaluate space and/or modify entry procedure before re-entering.
22. When work completed, return space to proper condition and secure opening.

End of Document



Contractor Safety Specification

Control of Hazardous
Energy

Table of Contents

1.0	Definitions & Acronyms	2
2.0	Contractor Responsibilities	4
3.0	Specification Requirements	6
3.1	Isolation	6
3.2	Lockout Equipment.....	6
3.3	Locks.....	7
3.4	Tags	7
3.5	Hasps/Scissor Clamps	8
3.6	Cables/Bars/Chains.....	8
3.7	Lockboxes	8
4.0	Lockout Requirements.....	9
4.1	Lockout/Tagout Changes	10
5.0	Contractors.....	10
6.0	Documentation.....	11
6.1	Energy Isolation Form	11
6.2	Lock Removal Authorization Form	12
7.0	Isolation Procedures	12
8.0	LOTO Training.....	12
9.0	References.....	12
10.0	Appendix	14
10.1	Appendix a – Energy Isolation Form	14
10.2	Appendix B – Lock Removal Authorization Form.....	16
10.3	Appendix C – Isolation over Distance	17
10.4	Appendix D - Car Seals.....	17

1.0 DEFINITIONS & ACRONYMS

Active energy—Primary energy source that is typically controlled with an energy isolation device.

Affected worker—A worker whose job requires him/her to operate or use equipment being modified, serviced, maintained, or repaired by others.

Alternative isolation procedure—Any procedure used for isolation that does not meet the requirement of positive isolation.

Authorized worker— A contractor performing lockout/tagout for installation, modification, servicing, maintenance and/or repair work on equipment and/or systems that has completed lockout/tagout training and is deemed qualified to implement the lockout/tagout requirements as outlined in this specification. The ability to isolate hazardous energy sources associated with the machines, equipment and/or systems being worked on will be limited to those that fall within the scope of their trade/occupation and associated qualifications.

Blanking - Inserting a physical barrier through the cross-section of pipe so material is prevented from flowing past that point. Blanks must be rated to contain the design pressure of the piping of the pressurized system.

Blinding - Disconnecting a pipe and attaching a physical barrier to the end so material is prevented from flowing out of the pipe. Blinds must be rated to contain the design pressure of the piping of the pressurized system.

Control of hazardous energy - Practice of shutting down, isolating, and locking out equipment and systems in accordance with this specification to prevent inadvertent start-up, operation, and release of potentially hazardous energy during work activities.

De-energize - A process that is used to disconnect and isolate a system from a source of energy in order to prevent the release of that energy.

Double isolation and bleed system (DIB) – When two seating surfaces, in the closed position, provide a seal against pressure from both sides with a means of venting/bleeding the cavity between the seating surfaces. DIB can be achieved by a single valve or by two valves with a bleed in between.

Enbridge—*Enbridge, Inc. and Enbridge (U.S.) Inc., hereinafter will be referred to as “Company”.*

Energized— Connected to an energy source or containing residual or stored energy.

Energy isolation device—A mechanical device that physically prevents the transmission or release of energy from a hazardous energy source.

Equipment Locks/Locksets (Company only) –Equipment Locks/Locksets are used for the protection of Company owned equipment/assets or to manage a temporary flow path. Locks can be in any color, other than red (*see also Red Lock/Lockset definition*), they may be keyed alike.

Group lockout—A lockout that is utilized when multiple workers/trades are performing service, maintenance, or repair to a piece of equipment or system

Hasps (scissor clamps)—A mechanical device that is used to secure an energy isolation device in position when installed in combination with one or more locks.

Hazardous energy—Any active or stored source of energy that may cause harm to people, property or process.

Isolation Point—The location where an energy isolation device is installed.

Isolation—Securing one or more isolation points on equipment or within a system in accordance with an established procedure in order to eliminate any potential sources of active and stored hazardous energy.

Lockbox—A container that securely stores lock keys and unused locks from locksets.

Lockout Authority (LOA) —Company/Company Representative (one per shift) must be an authorized worker and is accountable for overall coordination and implementation of isolation and lockout/tagout activities required to control hazardous energy in accordance with this specification.

Lockout—The placement of personal or equipment locks (individual or lockset locks) on an energy isolation device in order to prevent equipment or a system from being operated until the lock has been removed.

Positive Isolation - Isolation of harmful pressurized fluid (liquid or gas) by means of blanking, blinding, or double isolation and bleed (DIB).

Qualified —one who, by possession of a recognized degree, certificate or professional standing or who by extensive knowledge, training and experience, has successfully demonstrated his ability to solve or resolve problems relating to the subject matter, the work, or the project.

Personal Locks (Contractor only)- Locks used for the protection of people and are keyed individually.

Red Personal Locks (Company only)- are keyed individually and used for the protection of people. These are only assigned to Company Operations.

Red Lockset (Company only)- a pre-defined number of locks (red), that are keyed alike. Red locksets are used by Company Operations for the lockout of Company owned equipment/assets.

Simple Lockout – a lockout involving the application of a single lock where the work does not involve an open system or high voltage (above 600 Volts - US, above 750 Volts - Canada), and only a single source of energy is required to be isolated

Stored energy—Residual energy that remains in equipment or systems after operation/installation of an energy isolation device until further relieved, restrained, disconnected or otherwise dissipated.

Tagout—The placement of a prominent warning device, such as a tag and a means of attachment, which can be securely fastened on an energy isolating device, in accordance with an

established procedure, to indicate that the energy isolating device and the equipment being controlled may not be operated until the tagout device is removed.

Zero energy state—A condition where all active and stored energy to and within equipment or a system has been removed.

2.0 CONTRACTOR RESPONSIBILITIES

Contractor Management shall:

- Ensure, through formal and informal inspections, that contractors, and subcontractors under their control are aware of and comply with this specification,
- Ensure workers are appropriately trained
- Ensure that equipment and systems that are required to be serviced, maintained and repaired are isolated prior to work beginning
- Ensure the lockout/tagout equipment is readily available,
- Support development of equipment specific isolation and lockout procedures and assist the Company in the completion of associated Energy Isolation Forms as required.

Lockout Authority (Company Representative only) shall:

- Implement and ensure compliance with the requirements of this specification,
- Complete training for the control of hazardous energy,
- Stop/correct any issues of non-compliance with this specification,
- Coordinate and implement group lockout and isolation over distance when required,
- Ensure an Energy Isolation Form and/or Electrical Equipment Isolation and Work Clearance Form are completed,
- Perform or assign a designate to perform initial isolation of equipment and systems requiring lockout/tagout,
- Verify the isolation (test to ensure it is at a zero energy state),
- Implement the use of scissor locks/hasps at each isolation point or utilize a designated lockbox when required to accommodate group lockouts,
- Ensure all authorized workers working on equipment and systems being serviced, maintained and repaired lock-out and tag the appropriate isolation point(s) or that they apply a lock on a designated lock box,

- Manage changes to personnel, isolation points, equipment status and isolation documentation associated with a lockout/tagout and informing personnel of such changes, and
- Notify affected workers of the shutdown, isolation, lockout/tagout and re-energization of equipment and systems.

Authorized worker shall:

- Complete training for the control of hazardous energy,
- Comply with the requirements of this specification and stop/correct any issues of non-compliance,
- Follow the direction of the lockout authority (LOA) as it relates to isolation and lockout activities,
- Confirm the necessary testing has been performed to verify that hazardous energy sources have been isolated prior to applying personal locks and tags to isolation points of equipment and systems or a designated lock box,
- Apply a personal lock and tag on each isolation point identified on the Energy Isolation Form or on a designated lock box prior to working on any equipment and systems required to be isolated and/or locked out/tagged,
- Remove personal locks/tags applied to isolation points or a lock box when task is complete or at the end of each day/shift (whichever comes first), unless otherwise authorized to leave personal locks on for work that will extend greater than one day/shift in accordance with the limitations in this specification,
- Inform the lockout authority of the status of their work and of any equipment and systems being worked on at the end of each working day/shift or when their work is complete and their personal locks/tags are ready to be removed (whichever comes first), and
- Act as the lockout authority (LOA) when working alone or assigned to fulfill this role for a group lockout or isolation over distance.

Affected workers shall:

- Comply with the requirements of this specification and stop/correct any issues of non-compliance, and
- Not alter or attempt to reactivate any equipment or systems that have been isolated and locked/tagged out for the control of hazardous energy in accordance with this specification.

Contractors shall:

- Implement an effective control of hazardous energy specification that meets or exceeds all applicable regulatory requirements and the requirements set out in this specification,
- Ensure workers, through formal and informal inspections, under their control are aware of and comply with the requirements of the control of hazardous energy specification and the applicable requirements of this specification,
- Ensure workers are trained in the control of hazardous energy as required and provide record of training when requested
- Provide lockout/tagout equipment required for implementation of their control of hazardous energy specification and the applicable requirements of this specification and ensure it is readily available to their workers,
- Support development of equipment specific isolation and lockout procedures and assist the Company in the completion of associated Energy Isolation Forms as required.

3.0 SPECIFICATION REQUIREMENTS

3.1 ISOLATION

The extent of isolation required to control hazardous energy will depend on the purpose of the isolation (personal protection, equipment protection, or flow path management) and the scope of work (if any) being performed on the equipment and systems. Isolation of active energy sources can be achieved through operation of one or more energy isolating devices. Isolation of stored energy will require the energy to be bled off (e.g. venting of piping, electrical grounding) or otherwise restrained/secured (mechanical blocking).

3.2 LOCKOUT EQUIPMENT

Lockout equipment must:

- Be provided to the authorized worker as required,
- Not be used for purposes other than LOTO,
- Be capable of withstanding the environment in which it will be exposed for the period that exposure is expected, and
- Be substantial enough to prevent removal without the use of excessive force or unusual techniques (i.e., bolt cutters, metal cutting tools).

Tampering with any LOTO equipment is a serious offense and will result in disciplinary action.

3.3 LOCKS

The four types of locks used by the Company for LOTO to secure an isolation device in the appropriate position are red personal locks, red locksets, equipment locks, and equipment locksets.

3.3.1 Red Personal Locks/Locksets (Company only)

Red Personal locks are individually keyed locks with one key per lock that must be kept in the control of the worker who applies the lock.

Red locksets are keyed alike with one key for the entire set of locks. Each lock in a lockset is uniquely identified as being part of a set. They are commonly used in group LOTO situations or a LOTO with multiple isolation points.

3.3.2 Equipment Locks/Locksets (Company only)

Equipment locks may be used for:

- Long-term equipment shutdown,
- Out-of-service equipment,
- Isolations where protection to workers is not required, and
- Isolations for temporary alteration of a flow path provided a Company management of change (MOC) process is followed and procedure is documented.

If an authorized worker is isolating equipment for a contractor but not performing the work themselves (i.e., electrician locking out for a mechanic), they may use equipment locks at the isolation points. The Company is responsible for applying red personal locks to the isolation points.

Performing work on isolated Company assets, equipment or systems with just an equipment lock is prohibited.

3.3.3 Personal Locks (Contractor only)

Authorized contractor performing work on isolated Company equipment and assets/systems must install their own personal locks on each energy isolation device or a lockbox if used.

3.4 TAGS

Tags are used to indicate which Company individual has isolated and/or locked out an energy source. An authorized worker must attach a tag to each lock being installed for a lockout. In cases where an energy isolation device cannot physically accommodate the placement of a lock on it, tags shall be used without the lock. Tags must be applied to any blanks or blinds being installed for isolation and any auxiliary piping valves used multiple times for drain-up and venting. Tags used for these purposes can be used without locks. Each tag's location must be

documented on the Energy Isolation Form along with the equipment positions prior to starting work and when work is completed.

Tags must be:

- Designated for LOTO,
- Legible and understandable to others,
- Constructed and printed in a way that ensure they do not deteriorate or become illegible, and
- Substantial enough to prevent inadvertent or accidental removal. Replaced if weathered or illegible.

3.4.1 Generic Tags

A generic tag can be used in place of a photo ID tag if the authorized worker does not have a photo ID tag available and must, at a minimum, include the worker's:

- Personal Name,
- Contractor name,
- Phone number

A generic tag must be applied to each personal lock placed on the lockbox.

3.5 **HASPS/SCISSOR CLAMPS**

Hasps/scissor clamps are used to increase the number of locks that can be attached to one isolation point. They are designed so they cannot be opened or removed until all locks are removed and can be attached to each other (daisy chaining) to allow for additional locks at the one isolation point.

3.6 **CABLES/BARS/CHAINS**

The strength, diameter and routing of cables, bars or chains must be sufficient to prevent removal without tools and keep the energy isolating device in the appropriate position.

The system must provide a level of worker protection that is at least as good as if there was an individual securing device on each energy-isolating device.

3.7 **LOCKBOXES**

Lockboxes are used to simplify lockout procedures for group lockout. If a Company LOA isolates a system on behalf of a group, the Company LOA must place the keys to the personal locks and/or the red locksets used to isolate the system inside a Company lockbox and secure it closed with their personal lock on the front of the lockbox. This Company lockbox is referred to as the primary lockbox and becomes the single isolation point of the system.

Each authorized worker required to work on the system must place a personal lock on a lockbox. This ensures that the keys cannot be removed from the lockbox until each worker removes their personal lock.

Where more than one job is taking place on isolated equipment or systems, a separate LOTO is required and must be documented for each job. A Company LOA must be established for each job. Each Company LOA must place their personal lock on each energy isolation device including those devices that are common points of isolation for more than one job. The need for Company LOA's to place a personal lock on each other's lockboxes in addition to locking out each energy isolation device must be determined on a case by case basis at control and coordination meeting.

Authorized workers must be aware of the location of the lockbox(s) at all times.

Lockboxes must be:

- Lockable,
- Sealable,
- Readily identifiable,
- Used for one isolation at a time,
- Used to store the lockset key and any unused lockset locks,
- Able to accept a lock or a multiple lockout device —securing the box from unauthorized access, and
- Free from damage preventing its proper use.

Larger jobs with multiple workers may require the use of a secondary lockbox in conjunction with a primary lockbox. Instead of having all authorized workers LOTO at the primary lockbox, workers can LOTO at a secondary lockbox set up by their crew lead (e.g., a crew lead attaches a personal lock to the primary lockbox then places their key to that personal lock into a secondary lockbox). The authorized workers on their crew must LOTO at the secondary lockbox.

The Company LOA's personal lock and tag are always the first on the lockbox and the last off of the lockbox. The Company LOA's lock will be placed at the front securing point of the lockbox.

4.0 LOCKOUT REQUIREMENTS

The Company LOA will be the first to apply personal locks and or red locksets on each energy isolation device and/or a lockbox used as a single point of isolation once the isolation has been verified. Once the initial lockout is complete, each authorized worker performing work on the isolated Company machines, equipment and assets/systems must then install their own personal locks on each energy isolation device or a lockbox if used.

Once the work is complete, each authorized worker that applied a lock must remove it from the energy isolating device and/or lockbox. The Company lockout authority will be the last person to remove their personal locks and or red locksets from the energy isolation devices. Prior to doing so, the Company LOA must ensure:

- The work has been completed or otherwise rendered safe prior to returning the equipment or system to operation,
- All personnel and tools are accounted for,
- All energy isolation devices have been returned to their proper operating position, and
- All affected personnel have been notified of the plan to re-energize.

A worker installing a personal lock is the only person authorized to remove the lock and tag (the exception would be long-term isolation for contractor use as noted in Section 3.6). A worker cannot apply a lock on behalf of another person and may only remove another person's lock where authorized in accordance with the requirements of the Company Lock Removal Authorization Form (see Section 3.5.2).

4.1 LOCKOUT/TAGOUT CHANGES

4.1.1 Work Disruption

If the locked out equipment will not be worked on for more than 7 calendar days, contractor must remove all personal locks from lock boxes and/or isolation devices.

4.1.2 Scope of Work Changes

If the scope of work changes during isolation, the Contractor shall contact the Company LOA. The Company LOA must immediately stop the work, review the isolation validity and, once confirmed safe, allow work to resume.

If the scope of work change affects the isolation security and/or worker safety, the Energy Isolation Forms must be updated by the Company LOA and authorized/affected workers must be notified.

4.1.3 Shift Change

If work is to span over the course of multiple shifts, the Company LOA must complete a transfer of responsibilities during shift change. The incoming Company LOA must re-verify the lockout prior to applying their personal lock(s).

5.0 CONTRACTORS

Company Authorized workers must use Company LOTO equipment to isolate the required energy sources prior to contractors performing any activities related to servicing and/or maintenance of

equipment at company facilities. The only exception to this rule is when a hired contractor is performing work on Cathodic Protection Rectifiers. Contractors hired for this purpose are allowed to conduct LOTO without direct oversight from a Company Representative, provided the LOTO follows all Company LOTO requirements.

Contractors may provide their own equipment (i.e., personal locks) for their lockout portion; LOTO for a contractor can be performed using one of the following methods:

- 1) A Company Authorized Worker:
 1. Attaches personal red locks or red lockset locks and tags to the isolation points
 2. Places the keys in a lockbox,
 3. Attaches a personal red lock to the lockbox, and

The contractor:

4. Attaches their LOTO equipment to the lockbox;

- 2) A Company Authorized worker:
 1. Attaches a hasp/scissor clamp and personal red lock and tag to each isolation point.

The contractor:

2. Attaches their LOTO equipment to each isolation point, and
3. Follows their program (e.g., setting up a secondary lockbox for the rest of their crew).

Once the LOTO has been completed, the Company LOA verifies that the isolated equipment is at a zero energy state. Contractor management shall verify isolated equipment is at a zero energy state.

If a contractor worker would like to verify isolation, this must be accommodated by the Company LOA or Company designate.

Contractor workers who leave the worksite must remove all of their locks and tags from the isolations point(s).

For new construction isolation turnovers or tie-ins into pre-existing systems, all affected parties must communicate the status of the equipment being turned over.

6.0 DOCUMENTATION

6.1 ENERGY ISOLATION FORM

An Energy Isolation Form is required to be completed for all lockouts except simple lockouts. If utilizing simple lockout, the functional tag and description of the device being isolated and locked out along with the position of the device prior to isolation, during isolation and prior to start-up must be documented on the FLHA.

The Energy Isolation Form must be available to all workers performing the lockout during the work.

6.2 LOCK REMOVAL AUTHORIZATION FORM

The Lock Removal Authorization Form applies to all types of locks; use it if any of the following occurs:

- A lock has been abandoned,
- A key has been lost by a worker or work group, and/or
- An emergency situation develops.

The lock cannot be removed until all abandoned lock removal procedure steps have been performed. Unauthorized removal of a lock by anyone other than the worker or Company department to whom it belongs is prohibited.

If a lock is forcibly removed via the Lock Removal Authorization Form it is to be assumed that Energy Isolation has been lost, and work must be suspended until re-verification of the Energy Isolation has been completed by the Company LOA or Designate. The person whose lock is being removed, or the Contractor they report to, must be notified of the lock removal.

7.0 ISOLATION PROCEDURES

Where site specific isolation procedures exist, the Contractor will be notified of the procedures.

8.0 LOTO TRAINING

LOTO training is mandatory for authorized workers and must be completed prior to the worker servicing, maintaining, modifying, or repairing any equipment or systems that require Energy Isolation. Such training shall include a review of the roles and responsibilities during the LOTO process.

9.0 REFERENCES

United States

- American Petroleum Institute

-
- American Society of Safety Engineers
 - ANSI/ASSE Z244.1 – Control of Hazardous Energy – LOTO and Alternative Methods
 - API 6D – Specification for Pipeline Valves
 - Code of Federal Regulations (CFR), Title 29 Labor
 - Part 1910.147 Control of Hazardous Energy (LOTO)

Canada

- Alberta Occupational Health and Safety Code
- Canada Labour Code, Part II:
- Canadian Standards Association (CSA):
- CSA Z460 – Control of Hazardous Energy - Lockout and Other Methods
- Part 13 – Tools and Machinery
- Part 15 Managing the Control of Hazardous Energy
- Part 8 Electrical Safety



10.0 APPENDIX

10.1 APPENDIX A – ENERGY ISOLATION FORM

		Energy Isolation Form – Part I		ENB-FRM-0086	
A) PREPARATION					
Scope of Work/Reason:					SWP/CSE Permit #
Date of Work:		Location:		Lockset #	
CCO Contact Name:		CCO Phone:		CCO Email:	
Lockout Authority (LOA) Name – Day Shift:		Name – Night Shift:		Phone:	
Form Prepared By:					
Energy Isolation Plan					
Energy Type(s) To Be Isolated					
<input type="checkbox"/> Pressure <input type="checkbox"/> Electrical <input type="checkbox"/> Mechanical <input type="checkbox"/> Chemical <input type="checkbox"/> Biological <input type="checkbox"/> Thermal <input type="checkbox"/> Radiation <input type="checkbox"/> Other (specify):					
Energy Isolation Procedures Applicable to Work Available <input type="checkbox"/> Yes <input type="checkbox"/> No <i>If Yes, specify procedure to be used:</i>					
Energy Isolation Procedures for Work Require Development <input type="checkbox"/> Yes <input type="checkbox"/> No <i>If Yes, specify where documented:</i>					
<input type="checkbox"/> List Equipment to be Isolated on <i>Energy Isolation Form, Part IIA – Isolation Procedures/List</i>					
Piping System Isolation Method to be Used: <input type="checkbox"/> Not Applicable <input type="checkbox"/> Positive Isolation <input type="checkbox"/> Approved Alternate Isolation					
Vent/Drain Valves Req'd To Be Used for Work: <input type="checkbox"/> Yes <input type="checkbox"/> No <i>If yes, name of person assigned if not LOA:</i>					
Complex Group Control – Isolation Over Distance Required: <input type="checkbox"/> Yes <input type="checkbox"/> No <i>If Yes, provide the following:</i>					
Location of Remote Equipment Isolation		Site #1	Site #2	Site #3	
Name/Phone # of Worker Responsible for Remote Isolation					
Method Established to Verify Remote Isolation					
Notification of De-Energization					
Departments/Groups of Affected Personnel to be Notified:					<input type="checkbox"/> Notifications Complete
B) ENERGY ISOLATION					
Isolate Energy <input type="checkbox"/> Complete Isolation and record positions of energy isolating devices and application of locks on <i>Energy Isolation Form, Part IIB – Isolation</i>					
Verification of Isolation					
Lockout Authority or Designate		Name - Day Shift:		Date/Time:	
		Name - Night Shift:		Date/Time:	
Person Assigned to Verify Remote Isolation - Complex Group Control		Name – Site 1:		Date/Time:	
		Name – Site 2:		Date/Time:	
		Name – Site 3:		Date/Time:	
For Contractor Work - Person In Charge		Name – Day Shift:		Date/Time:	
		Name – Night Shift:		Date/Time:	
Transfer of Lockout Authority Required: <input type="checkbox"/> Yes <input type="checkbox"/> No <i>If Yes, identify new Lockout Authority along with transfer and re-verification date/time</i>					
New Lockout Authority		Name – Day Shift:		Date/Time:	
		Name – Night Shift:		Date/Time:	
Transfer of Contractor Person in Charge Required: <input type="checkbox"/> Yes <input type="checkbox"/> No <i>If Yes, identify new Contractor Person in Charge along with transfer and re-verification date/time</i>					
Contractor - New Person in Charge		Name - Day Shift:		Date/Time:	
		Name - Night Shift:		Date/Time:	
C) ENERGY ISOLATION REMOVAL					
Work Completion All work on equipment is complete, personnel and tools are accounted for, and equipment has been restored to normal operating condition? <input type="checkbox"/> Yes <input type="checkbox"/> No <i>If No, what measures have been taken?</i>					
Isolation Removal <input type="checkbox"/> Remove locks and other safety controls installed for isolation, return equipment to position required for start-up, and record on the <i>Energy Isolation Form, Part IIC – Isolation Removal</i>					
Notification of Re-Energization <input type="checkbox"/> Departments/Groups of Affected Personnel Have Been Notified of Re-Energization					
Final Verification of Isolation Removal – All Locks Removed and Energy Isolating Devices Are Placed in Proper Position					
Lockout Authority or Designate		Name:		Date/Time:	
For Contractor Work - Person In Charge		Name:		Date/Time:	



ENBRIDGE		Energy Isolation Form – PART II										ENB-FRM-0086				
		Legend O/C – Open/Close A- Auto/Remote L-Local/MCC O - Off														
#	Steps Used to shutdown/isolate or List of Equipment to shutdown/isolate if Isolation Procedure documented elsewhere	Equipment Status				Isolation/Lockout Complete				Locks Removed		Equipment Status		Comments		
		Prior to Isolation		During Isolation		Mechanical		Electrical		Mech	Elect	As Left			Prior to Restart	
		Mech (O/C)	Elect (O/C - A/U/O)	Mech (O/C)	Elect (O/C - A/U/O)	Lock #	Initial	Lock #	Initial	Initial	Initial	Mech (O/C)	Elect (O/C - A/U/O)	Mech (O/C)	Elect (O/C - A/U/O)	
1.																
2.																
3.																
4.																
5.																
6.																
7.																
8.																
9.																
10.																
11.																
12.																
13.																
14.																
15.																
16.																
17.																
18.																

Version 2.0 (Revised 2019-11-01)

INTERNAL INFORMATION

Page 2 of 4



10.2 APPENDIX B – LOCK REMOVAL AUTHORIZATION FORM



Lock Removal Authorization Form

Unauthorized removal of a personal or equipment lock by anyone other than the person it belongs to, without proper authorization, will be subject to disciplinary action in accordance with the lifesaving rules.
The intent of this form is to ensure that the necessary steps have been taken before lock removal in order to safeguard personnel. This form addresses both personal and equipment locks.

Personal Lock Removal

Date:		Lock Location:	
Lock Owner Name:			
Lock Removal Reason:			
Machinery, Equipment or System Description:			
Individual Requesting Removal:		Phone #:	

NOTE: The following 4 questions must be answered:

1	Was a search of the job site conducted to ensure that the worker is no longer there?	<input type="checkbox"/> Yes	Must be a "Yes"	A thorough search must be completed.
2	Was the lock owner able to be contacted? (Attempts must be made)	<input type="checkbox"/> Yes	<input type="checkbox"/> No	Phone #: _____ Time: _____
3	Did the lock owner give verbal permission to remove the lock?	<input type="checkbox"/> Yes	<input type="checkbox"/> No	Enter time of verbal authorization and initial Time: _____ Initial: _____
4	LOA(Name): _____	Did the LOA give permission to remove the lock?	<input type="checkbox"/> Yes	Must be a "Yes" Enter time of verbal authorization and initial Time: _____ Initial: _____

Equipment Lock Removal

Date:		Lock Location:	
Lock Removal Reason:			
Individual Requesting Removal:		Phone #:	

NOTE: The following 2 questions must be answered:

1	Is the isolation ready to be removed?	<input type="checkbox"/> Yes	Must be a "Yes"	All permits signed off
2	Supervisor (Name): _____	Did the Supervisor give permission to remove the lock?	<input type="checkbox"/> Yes	Must be a "Yes" Enter time of verbal authorization and initial Time: _____ Initial: _____

LOA keeps the completed Lock Removal Authorization Form for 2 years and sends a notification to the Regional Health and Safety Coordinator.

10.3 APPENDIX C – ISOLATION OVER DISTANCE

In some cases, it may not be reasonably practicable to use a personal or group lock out process. To maintain worker safety, normal personal or group lock out practices may need to be adapted or modified into what is referred to as isolation over distance process. This process is implemented and coordinated by the Company LOA.

A reason for choosing to use isolation over distance may be due to the equipment and/or pipeline occupying such a large area (or occupying multiple areas) that it becomes impractical for the Company LOA to personally secure all energy isolation devices. Some of the devices when isolating over distance may need to be isolated and secured by another worker (e.g., control room operator, authorized worker at another field location) due to the distance between the work area and the isolation devices.

A copy of the Energy Isolation Form must be forwarded to the remote site authorized worker prior to isolation and lockout. The Company LOA must document and verify secured and effective isolation through direct communication with the worker completing the isolation with lockout locks at the remote site.

The authorized worker completing the isolation at the remote site must maintain control of the key(s). Alternatively, the keys to the locks can be brought to the location where work is being performed and added and secured in a lockbox at the work area.

The Company LOA can begin coordinating the return to operation process only when all personal locks have been removed by the workers at the work area and the remote site(s).

10.4 APPENDIX D - CAR SEALS

The removal and re-application of car seals is required to be documented on the Energy Isolation Form by indicating the status of the car seal prior to isolation and prior to restart (e.g. CSO – Car Seal Open; CSC – Car Seal Closed). This can only be performed by an authorized Company worker.

End of Document

Uncontrolled Copy if Printed or Downloaded

Internal Information



Specification

Electrical Safety

Table of Contents

1.0	Definitions & Acronyms.....	3
2.0	Contractor Responsibilities	7
3.0	Specification-Specific Requirements.....	9
3.1	Electrical Hazards & Controls	9
3.2	Worker Qualifications And Electrical Work Tasks	9
3.3	Electrical Safe Work Requirements.....	10
3.3.1	Establishing an Electrically Safe Work Condition	10
3.3.2	Energized Electrical Work	12
3.3.3	Energized Electrical Work Permit.....	13
3.3.4	Arc Flash and Shock Hazard Risk Assessment.....	14
3.3.5	Arc Flash & Shock Approach Boundaries	16
3.3.6	Electrical Work Zone	16
3.4	Electric Specific PPE, Tools and Equipment.....	17
3.4.1	Electrical PPE.....	17
3.4.2	Electrical Tools & Equipment	19
3.5	Energized Electrical Safe Work Practices	19
3.6	High Voltage Substations	21
3.7	Working Alone.....	24
3.8	Look Alike Equipment	24
3.9	Temporary Power Systems	24
3.10	Electrical Incidents and Reporting.....	25
3.11	Electrical Emergency Response	26
3.11.1	Methods of Release	26

4.0	References.....	27
	Appendix.....	28
	Appendix A – Electrical Work Tasks By Qualification Category	28
	Appendix B – TEMPORARY Protective Grounding Signage.....	31
	Appendix C – Electrical Equipment Isolation & Work Clearance Form.....	32
	Appendix D – Energized Electrical Work Permit.....	34

1.0 DEFINITIONS & ACRONYMS

Approved Electrical Test Equipment: Is tested and certified to the applicable UL standards and shall bear a label of an accredited certification testing body.

Arcing Fault Current: A fault current flowing through an electrical arc plasma, also called arc fault current and arc current.

Arc Blast: Associated with the release of pressure as a result of arcing fault current.

Arc Flash Hazard: A dangerous condition associated with the release of energy caused by an electric arc.

Note: An arc flash hazard can exist when energized electrical conductors or circuit parts are exposed or are within equipment in a guarded or enclosed condition if a person is interacting with the equipment in a manner that could cause an electric arc. Under normal operating conditions, enclosed energized equipment that has been properly installed and maintained is not likely to pose an arc flash hazard.

Arc Flash Risk Assessment (AFRA): A study investigating a worker's potential exposure to arc flash energy, conducted for the purpose of injury prevention and the determination of safe work practices, Arc Flash Boundary (AFB), and the appropriate levels of personal protective equipment.

Arc Flash Boundary (AFB): When an arc flash hazard exists, an approach limit at a distance from energized electrical conductors or circuit parts within which a person could receive a second degree burn (e.g. 1.2 cal/cm² or 5.0 joules/cm² of incident energy exposure).

Arc Flash PPE Category: A method of completing an arc flash risk assessment that uses electrical equipment type, voltage, and energized work task descriptions with an associated maximum short circuit current and maximum fault clearing time to determine arc flash protective clothing requirements.

Arc Flash Suit: A complete arc-rated clothing system that covers the entire body except for the hands and feet. It includes bib-overall pants, a coat, and a bee-keeper style hood fitted with a face shield. It is recommended that the hood includes an integral cooling fan and LED lamp.

Arc Rating (AR): The value attributed to materials that describes their performance on exposure to an electrical arc discharge. The arc rating is expressed in cal/cm² or joules/cm² and is derived from the determined value of the Arc Thermal Performance Value (ATPV) or energy of breakopen threshold energy (E_{BT}) (if a material system exhibits a breakopen response below the ATPV value).

Note: 'Breakopen' is a material response evidenced by the formation of one or more holes with an area of 16 mm² (0.5 in²) or an opening of 25 mm (1.0 in) in any dimension in the innermost layer of flame-resistant material that can allow flame to pass through the material.

Arc Resistant Switchgear: Switchgear designed and built to provide maximum safety in the event of an Internal Arcing Fault. Designed to withstand the high pressures created by an arcing event and directs the internally released energy away from the worker. This provides a high degree of protection to personal in the vicinity of the switchgear.

Arc Thermal Performance Value (ATPV): Defined in *ASTM F1959* as the incident energy on a material or a multilayer system of materials that results in 50% likelihood that sufficient heat transfer through the tested specimen is predicted to cause the onset of a second-degree skin burn injury based on the Stoll curve.

Authority Having Jurisdiction: An organization, office, or individual responsible for enforcing regulations or the requirements of a code or Standard, or for approving equipment, materials, an installation, or a procedure.

Balaclava (sock hood): An arc-rated flame-resistant hood that protects the neck and head, except for the area of the eyes and nose.

Blind Reaching: Placing a body part, usually a hand or finger, into an area that is not directly visible or not visible due to inadequate lighting.

Breakopen Threshold Energy (E_{BT}): The incident energy on a material or material system that results in a 50% likelihood of breakopen. When ATPV ratings cannot be used due to fabric breakopen, the E_{BT} rating is applied. E_{BT} is defined in *ASTM F 1959* standard and consists of the average of the five highest incident energy levels that did not generate a second degree burn exposure level (1.2 cal/cm²) and did not cause fabric to breakopen.

Circuit Breaker (CB): A device designed to open and close a circuit by non-automatic means and to open the circuit automatically on a predetermined overcurrent without damage to itself when properly applied within its ratings.

Competent Worker: Based on validation a worker who has suitable qualifications, training, knowledge, and experience to undertake specific work tasks.

Conductor: A wire, cable, or other form of metal installed for the purpose of conveying electric current from one piece of electrical equipment to another or to ground.

De-energized: Free from any electrical connection to a source of potential difference and from electrical charge; not having a potential different from that of the earth.

Direct Supervision: Means that a 'Qualified Electrical Worker' is working with the 'trainee' in the same location and is available for direct communication, not by remote means.

Disconnecting Means: A device, group of devices or other means by which the conductors of a circuit can be disconnected from their supply source.

Electrical Hazard: A dangerous condition such that contact or equipment failure can result in electric shock, arc flash burn, thermal burn, or blast. See section 6.3 for further information on electrical shock, arc flash and arc blast hazards.

Note: Power supplies approved as extra-low voltage, extra-low voltage lighting systems and similar sources are examples of circuits or systems that are not considered an electrical hazard.

Electrically Safe Work Condition: A state in which an electrical conductor or circuit part has been disconnected from energized parts, locked out in accordance with established standards, tested to ensure the absence of voltage, and grounded (if grounding is deemed necessary).

Enbridge—Enbridge, Inc. and Enbridge (U.S.) Inc., hereinafter will be referred to as “Company”.

Energized: Electrically connected to or having a source of voltage.

Energized Electrical Work Permit: A written document that ensures that a work task requiring increased exposure to shock and/or arc flash injury provides notification to the equipment owner, the Supervisor and the worker(s) that the risk of injury is increased. It provides the opportunity to re-evaluate the necessity for the increased risk of injury.

Energized Parts: Electrically energized conductive components.

Exposed: (as applied to energized electrical conductors or circuit parts). Capable of being inadvertently touched or approached nearer than a safe distance by a person. This term is applied to electrical conductors or circuit parts that are not suitably guarded, isolated, or insulated.

Ground-Fault Circuit Interrupter (GFCI): GFCI's are reliable devices that limit fault current and prevent electrocutions. They are intended for the protection of personnel and function to de-energize a circuit or portion thereof within an established period of time when a current to ground exceeds the values established.

Guarded: Covered, shielded, fenced, enclosed, or otherwise protected by suitable covers, casings, barriers, rails, screens, mats, or platforms to remove the likelihood of approach or contact by persons or objects to a point of danger.

High Voltage: For the purpose of this worker safety standard, high voltage is >750V CAN; >600V USA.

Incident Energy (E): The amount of energy impressed on a surface, a certain distance from the source, generated during an electrical arc event. Incident energy is measured in calories/cm² or joules/cm².

Incident Energy Analysis: The determined and documented incident energy exposure of the worker in cal/cm². The exposure level shall be based on the working distance of the worker's face and chest areas from a prospective arc source for the task to be performed. Arc-Rated clothing and personal protective equipment is selected on the basis of the Incident Energy exposure associated with the specific task. Because Incident Energy increases as the distance from the

Arc Flash decreases, additional personal protective equipment is required for any parts of the body that are closer than the distance at which the incident energy was determined. Included in the risk assessment is the calculation of the applicable Arc Flash Boundary.

Insulated: Separated from other conducting surfaces by a dielectric barrier (including air space) offering a high resistance to the passage of current.

Isolated (from power sources): Secure physical separation or blocking with non-conductive material sufficient to ensure equipment cannot be energized by identified power sources.

Limited Approach Boundary, Shock: An approach limit at a distance from an exposed energized electrical conductor or circuit part within which a Shock hazard exists.

Lockout: Placement of a lock on an energy-isolating device in accordance with an established procedure, thereby indicating that the energy-isolating device is not to be operated until removal of the lock or in accordance with an established procedure.

Lockout Device: A mechanical means of locking that uses an individually keyed lock to secure an energy-isolating device in a position that prevents energization of a machine, equipment, or a process.

Low Voltage: For the purpose of this worker safety standard, low voltage is $\leq 750\text{V CAN}$; $\leq 600\text{V USA}$.

Normal Operating Conditions: Where: the equipment is: properly installed; properly maintained; is used in accordance with instructions included in the listing and labeling (e.g. Canadian Electrical Code, Part II Standard, in Canada and National Electrical Code in USA) and in accordance with the manufacturer's instructions; used with all equipment doors closed and secured; covers are in place and secured; and there is no evidence of impending failure.

Operator-in-Charge: An individual that is knowledgeable and experienced in the operation of high voltage substations who has been assigned the responsibility for the operation of the electrical system. Has authority within their jurisdiction to approve or reject work performed on the electrical system. Is responsible for maintaining the requirements of the Interconnection Agreement if one is in place with other electrical systems.

Overcurrent: A current in excess of the rated current of equipment or the ampacity of a conductor. It can result from an overload, short circuit or ground fault.

Overload: Operation of equipment in excess of normal, full-load rating, or of a conductor in excess of rated ampacity that, when it persists for a sufficient length of time, will cause damage or dangerous overheating.

Restricted Approach Boundary, Shock: An approach limit at a distance from an exposed energized electrical conductor or circuit part within which there is an increased likelihood of shock, due to electrical arc over combined with inadvertent movement, for personnel working in close proximity to the energized electrical conductor or circuit part.

Temporary Protective Grounds (TPG): Devices installed temporarily on de-energized electric power circuits for the purpose of potential equalization and to conduct a short circuit current for a specified duration (time).

Voltage Class: A voltage designation (low, medium or high) assigned to electrical equipment used within industrial and commercial power systems in accordance with recommended IEEE standards. These designations are used by Company for the purpose of classifying voltage ranges of equipment for design and maintenance purposes as established within the Company's Engineering Standards and Job Plans. They are not used for determining worker safety requirements.

Low Voltage Equipment - <1000V

Medium Voltage Equipment – 1000V - <100kV

High Voltage Equipment – >100kV

Working Distance: The dimension between the possible arc point and the head and body of the worker positioned in place to perform the assigned task. Default working distances are provided in IEEE 1584 as 18" for low voltage equipment, 24" for low voltage switchgear and 36" for high voltage switchgear (e.g. 4,160V, 13,800V, 25,000V, etc.).

Working On (energized electrical conductors or circuit parts): coming in contact with energized electrical conductors or circuit parts with the hands, feet, or other body parts, with tools, probes, or with test equipment, regardless of the personal protective equipment a person is wearing. There are two categories of "Working On":

Diagnostic (testing): taking readings or measurements of electrical equipment with approved test equipment that does not require making any physical change to the equipment.

Repair: any physical alteration of electrical equipment such as making or tightening connections, removing or replacing components, etc.

2.0 CONTRACTOR RESPONSIBILITIES

Contractor Management shall:

- Ensure electrical incidents are investigated and corrective and preventative actions arising from such investigations are followed up on as required.
- Identify and specify electrical specific PPE, Tools and Equipment for use where required.
- Develop and maintain electrical safe work practices and associated technical support resources to assist with implementation of the same.

- Ensure workers are aware of the electrical hazards of arc flash and shock and that they assist in the assessment and mitigation of the risk of specific energized electrical work tasks to as low as reasonably practicable in accordance with the requirements of this specification.
- Ensure that workers who are exposed to energized electrical conductors or circuit parts are trained, qualified and authorized to undertake the work task.
- Ensure competency of the workers they supervise is validated in accordance with technical competency program.
- Ensure that approved and appropriate electrical specific PPE, tools and equipment are provided, available, tested, inspected, maintained, and used where applicable and as required for the work.
- Monitor worker compliance with the requirements of this specification by inspecting and observing work activities and completing documentation reviews.
- Lead or support investigations of electrical incidents including electrical safety related near misses and ensure timely completion of assigned corrective and preventative actions.

Contract Workers shall:

- Complete required electrical safety and technical training as assigned.
- Identify and understand the electrical hazards of arc flash and shock associated with assigned work tasks along with all other hazards, assess the risk of such tasks, and implement effective preventive and protective control measures as per the hierarchy of risk control methods to eliminate or reduce the risk to as low as reasonably practicable.
- Only perform electrical work tasks for which they are trained, qualified and authorized to undertake.
- Comply with the requirements of this specification and all applicable Codes and Regulations.
- Test, inspect, maintain and use approved electrical specific PPE, tools and equipment as required for the work.
- Do not perform energized electrical work unless and approved by the Company in accordance with the requirements of this specification.
- Communicate any issues, concerns or changes required to electrical installations, programs, specification and practices identified to respective Contractor Supervisor for review and follow-up as required.

- Report all incidents including near misses immediately to their Contractor Supervisor and actively participate and cooperate in investigations of such incidents as required.

3.0 SPECIFICATION-SPECIFIC REQUIREMENTS

3.1 ELECTRICAL HAZARDS & CONTROLS

The two primary hazards associated with performing electrical work tasks and non-electrical work within close proximity of energized electrical conductors are electric shock and arc flash (with associated arc blast).

Shock Hazards shall be considered at any voltage equal to or greater than 30 VAC as defined in CSA Z462 or 50 VAC as defined in NFPA 70E. Shock hazards exist for both AC and DC voltage/current.

Preventative and protective control methods should be considered on a priority basis as per the hierarchy of risk control methods as listed below to mitigate or reduce exposure to electrical hazards:

1. Elimination – Physically remove the hazard by de-energizing, isolating and locking out electrical energy sources to establish an ‘Electrically Safe Work Condition’
2. Substitution – Replace the hazard through use of safer systems, processes or materials
3. Engineering Controls – Isolate workers from the hazard through ‘Safety by Design’, and Equipment ‘Safety by Design’ including effective electrical equipment maintenance
4. Administrative Controls - Change the way people work through training, procedures, warning/danger signs and barricading
5. PPE – Protect the worker with electric specific PPE, tools and equipment with proper care, use and maintenance

3.2 WORKER QUALIFICATIONS AND ELECTRICAL WORK TASKS

All workers completing electrical work tasks shall be qualified for the tasks they perform and, as a minimum, follow the requirements of this standard, CSA Z462 in Canada or NFPA 70E in the USA and all other applicable electrical standards, codes and regulations. They shall be trained in safety-related work practices and procedural requirements as necessary to provide protection from the electrical hazards associated with their respective job or work task assignments. They shall also receive technical training for the specific electrical equipment they work on.

The types of electrical work tasks workers are authorized to perform will depend on their level of qualification. The Company has established six categories of electrical qualification as follows based on a worker’s level of electrical knowledge and skills:

- **Qualified Electrical Worker (QEW)** – Qualified Electricians (US), Journeymen Electricians unless otherwise approved and deemed qualified (CAN), Electrical Engineers/Technologists, Power Line Technicians
- **Associate Electrical Worker (AEW)** – Apprentice Electricians (CAN), Qualified Electrical Workers-in-Training (US)
- **Task Qualified Worker (TQW)** – HVAC, Fire, Overhead door, Crane, & Cathodic Protection system Technicians
- **Qualified Instrumentation Worker (QIW)** – Instrumentation Technicians
- **Qualified Operations Worker (QOW) (Company)** – Mechanical Technicians, PLM Technicians, Operations Technicians, Field Operators
- **Non-Electrical Worker (NEW)** – All other workers that do not meet the criteria of a QEW, AEW, TQW, QIW, QOW.

See 'Appendix A' for table indicating the types of electrical work tasks workers are authorized to perform based on their level of electrical qualification.

3.3 ELECTRICAL SAFE WORK REQUIREMENTS

All Workers are expected to follow the electrical safe work requirements as established in CSA Z462 and NFPA 70E. These include:

- Establishing an electrically safe work condition by de-energizing, locking out, and testing electrical equipment before working on it.
- Completing a Risk Assessment for an assigned energized electrical work task.
- Conducting an equipment-specific Arc Flash Risk Assessment and Shock Risk Assessment for a justified energized electrical work task.
- Applying the Arc Flash Boundary and Shock Approach Boundary to the work task.
- Establishing an Electrical Work Zone and providing a suitable barrier to restrict access at the Arc Flash Boundary or Limited Approach Boundary for Shock whichever is further away.
- Ensuring electric specific PPE, tools and equipment that meets CSA, UL, ASTM, ANSI and other applicable Standards is specified, used, maintained and worn appropriate to the hazard.
- Reporting all electrical incidents including near misses
- Implementing an appropriate Emergency Response Plan for electrical incidents

3.3.1 ESTABLISHING AN ELECTRICALLY SAFE WORK CONDITION

All electrical equipment shall be de-energized and placed in an electrically safe work condition by a Company qualified electrical worker prior to commencement of work on it unless the work is

otherwise justified and/or approved to be completed in an energized state as per the requirements of this standard. All electrical equipment shall be considered energized until it is proven de-energized (e.g. tested for absence of voltage – “TEST-BEFORE-TOUCH”).

To establish an electrically safe work condition, the following process is to be followed:

1. Determine all possible sources of electrical supply to the specific equipment. Check applicable up-to-date Single Line Diagrams and identification tags against what exists in the field.
2. Properly interrupt the load current and open (i.e. turn off) the disconnecting device(s) for each source.

Note: The following are **not** considered as a means of disconnection:

- Shutting off a control interlock or other device
- Using three or four-way switches
- Switching off the control switch of a motor

Switching and Isolation Orders for power distribution systems shall be approved by the Company Qualified Electrical Worker with High Voltage training.

3. Where possible, visually verify that all blades of the disconnecting devices are fully open or draw-out type circuit breakers are withdrawn to the fully disconnected position.

Note: Equipment is to be left in ‘Normal’ condition, i.e. covers are not removed or doors opened to visually check knife blades or contacts.

4. Apply lockout/tagout devices in accordance with the Control of Hazardous Energy Specification.
5. Release stored electrical energy.
6. Release or block stored mechanical energy.
7. Use an adequately rated test instrument (e.g. voltage detector) to test each phase conductor or circuit part to verify they are de-energized. Before and after each test, determine that the test instrument is operating correctly – i.e. TEST-BEFORE-TOUCH
 - On electrical equipment greater than 750V in Canada or greater than 600V in the USA, the use of a non-contact test instrument is approved for use.
8. Where the possibility of induced voltages or stored electrical energy exists, ground the phase conductors or circuit parts before touching them. Where it could be reasonably anticipated that the conductors or circuit parts being de-energized could contact other exposed energized conductors or circuit parts, apply temporary protective ground connecting devices (e.g. follow an approved procedure for the use

and application of temporary protective grounds or Ground Truck Test Devices) rated for the available fault duty. Post a sign indicating the presence of temporary protective grounding in a readily visible location (e.g. on outside of cabinets/enclosures) on the equipment being grounded. See '**Appendix B**' for image of the sign.

Complete an Electrical Equipment Isolation & Work Clearance Form when providing grounds on high voltage and upstream of the 480V (600V) main breakers. See '**Appendix C**' for a sample of the form.

***Note:** Shutting off a control interlock or other device is not considered a disconnecting means. Three or four-way switches are not considered as a disconnecting means. Switching off the control switch of a motor is not considered a disconnecting means.*

3.3.2 ENERGIZED ELECTRICAL WORK

Energized electrical work is defined by Company as:

- Intentionally entering and performing a work task inside the Restricted Approach Boundary for Shock.
- Interacting with electrical equipment in which conductors or circuit parts are not exposed, but an increased likelihood of injury from an exposure to an arc flash hazard exists.

Some examples of work tasks that are considered energized electrical work are:

- Voltage measurement.
- Current measurement.
- Insertion or removal (racking) in and out power circuit breakers.
- Disconnecting and reconnecting batteries.
- 'Justified' repair and alteration of conductors and circuit parts in an energized state.

A Risk Assessment is required to be completed for all energized electrical work tasks performed by qualified electrical workers (QEW's). The purpose of the assessment is to evaluate the overall risk level of the energized electrical work task and to identify controls required to mitigate the risk to an acceptable level. This Risk Assessment is required to be made readily available to all QEW's performing energized electrical tasks and shall be used by those performing the work in determining the level of risk control necessary to mitigate the risks under the identified operating conditions.

If a worker is required to perform a non-routine task or a task outside the identified operating conditions, they shall first complete a documented Risk Assessment for that task in accordance with Enbridge's Risk Assessment process. Project executed construction and commissioning tasks will compile energized electrical work documentation in accordance with the projects document retention policy. The need to add such tasks to the Energized Electrical Work Task Risk Register will be reviewed by the Electrical Safety Advisory Team.

Contractors and commissioning workers planning to execute Electrical Work tasks on greenfield project sites, should apply Lock Out / Tag Out (LOTO) procedures in accordance with the appropriate regulatory requirements. In the event a task is required to be completed in an energized state due to infeasibility, the project team shall follow the energized electrical work permit process described below. The Operations Technical Supervisor signature may not be required for greenfield sites.

3.3.3 ENERGIIZED ELECTRICAL WORK PERMIT

Further to a the requirement for a risk assessment, an Energized Electrical Work Permit (see 'Appendix D' for a sample of the Energized Electrical Work Permit form) is required when crossing the Restricted Approach Boundary; or when an individual interacts with equipment where conductors or circuit parts are not exposed, but an increased likelihood of injury or damage to health from an exposure to an arc flash or shock exists, including closed equipment. There are exceptions to the need for this permit for specific energized electrical work tasks as outlined further within this section.

Where an Energized Electrical Work Permit is required for Project construction work, Section 1 is to be completed by Enbridge Construction Manager responsible for the work with input of all other affected worker(s) involved. Section 2 should be completed by the Contractor Qualified Electrical Worker performing the work. Section 3 will need to be approved by Operations Electrical Supervisor (not applicable for all greenfield work) and Project Manager prior to work commencing.

Where an Energized Electrical Work Permit is required for Commissioning tasks, Section 1 should be completed by the Commissioning Coordinator responsible for the work with input of all other affected worker(s) involved. Section 2 should be completed by the Commissioning Qualified Electrical Worker performing the work. Section 3 will need to be approved by the Operations Electrical Supervisor (not applicable for greenfield work) and Project Manager prior to work commencing.

The information identified on the Energized Electrical Worker Permit and referenced documents (e.g. JHA's, FLHA's, Procedures etc.) shall be reviewed at the pre-job meeting held prior to the commencement of work. All workers involved in the work must be present and actively participate in the pre-job meeting. Additional meetings may be required to acquire the necessary signatures for approving the Energized Electrical Work Permit. When all workers have completed the pre-job meeting for approved energized work, a Safe Work Permit will be documented on the Energized Electrical Work Permit including start/end times for approved energized electrical work.

Work can only be justified to be performed in an energized condition when either of the two following conditions can be satisfied:

- it can be demonstrated that de-energizing introduces additional or increased hazards or risk,
- the task to be performed is determined to be infeasible in a de-energized state because of equipment design or operational limitations.

Energized Electrical Work Permits are not required for the following energized electrical work performed by a Qualified Electrical Worker using approved safe work practices/procedures and appropriate Electrical Specific PPE, Tools and Equipment:

1. Working on electrical conductors or circuit parts that operate at less than 30 VAC in Canada and 50 VAC in the USA to ground if the capacity at the source and any overcurrent protection between the energy source and the worker are considered and it is determined that there will be no increased exposure to arc flash and arc blast.
2. Testing, trouble shooting, and voltage and current measurements.
3. Thermography, acoustical or visual inspections if the Restricted Approach Boundary for shock is not crossed (e.g. for 208VAC/480VAC/600VAC electrical equipment this distance is 12”).
4. Access and egress to an area with energized electrical equipment if no electrical work is performed and the Restricted Approach Boundary for shock is not crossed.
5. General housekeeping and miscellaneous non-electrical work tasks if the Restricted Approach Boundary for shock is not crossed.
6. Racking in or out low or high voltage power circuit breakers due to infeasibility.
7. Installing temporary protective grounds due to infeasibility.
8. Remove bolt on covers for voltage measurement due to infeasibility.
9. Open hinged doors on energized electrical equipment due to infeasibility.
10. Operating energized electrical equipment due to infeasibility
11. Removing or installing conductors and circuit parts less than or equal to 125VDC/AC such as relays, control equipment, analyzers, or PLC components in electrical equipment due to infeasibility.

3.3.4 ARC FLASH AND SHOCK HAZARD RISK ASSESSMENT

The Company conducts engineering incident energy analyses to assess the arc flash and shock hazards associated with energized electrical conductors or circuit parts. The results of these analyses are included on detailed arc flash and shock warning labels applied to all installed electrical equipment. These labels are used to identify the:

- Incident Energy Level impressed on the worker (i.e. head and torso) at the assumed working distance and arc flash boundary distance

- Maximum voltage, Limited Approach Boundary and Restricted Approach Boundary
- Class of Rubber Insulating Gloves to be worn.

This information is further used for the selection of appropriate electrical specific PPE, tools & equipment required to protect personnel from such hazards and reduce risk.



WARNING

Electrical Hazards - Appropriate PPE Required - Refer to Enbridge Electrical Safety Standard

ARC FLASH HAZARD	
8.82 cal/cm²	Incident Energy @ 36 in
116 in	Arc Flash Boundary

SHOCK HAZARD	
4160 VAC	Shock Hazard
1	Glove Class
60 in	Limited Approach
26 in	Restricted Approach

Bus Name: 209-BPM-1-FVC
Prot. Device: 209-SWGR-2-VCB-SEL-751A
 SKM Model: Hardisty Terminal (YP) 10 May 2019
Questions? Contact Enbridge Operations Engineering

Figure 1 – Sample Detailed Arc Flash and Shock Warning Label

When an energized electrical work task is approved by the Company, the arc flash and shock hazard information identified on the label of the equipment being worked on must be documented on the Energized Electrical Work Permit completed for the work. If an Energized Electrical Work Permit is not required, this information should be documented within the Hazard Assessment completed for the work.

Energized electrical work is not authorized above an incident energy level of 40 cal/cm² unless ARC Flash PPE that exceeds the maximum incident energy level is available for use and a documented risk assessment is conducted to determine requirements for mitigation. The level of residual risk will dictate the level of Company approval required to proceed at the incident energy levels.

Workers shall consult their Supervisor if equipment is not clearly labeled with an arc flash and shock warning label, the Incident Energy Level of a given task is unclear or unknown, or other

factors are unknown. In such cases, the voltage of the system is required to determine the electrical specific PPE, tools and equipment required and the shock protection boundaries. Refer to the shock protection boundary tables in CSA 462 Clause 4.3.4.4 Tables 1A & 1B (CAN) and NFPA 70E 130.4(D) Tables 130.4(D) (a & b) (US) to determine the limited and restricted approach boundaries for shock. Further, the Arc Flash PPE Category Method as specified in CSA 462 Clause 4.3.7.3.15 Tables 6A & 6B (CAN) and NFPA 70E 130.7 (C)(15) Tables 130.7(C)(15) (a & b) (USA) may be required to be used for the selection of arc flash PPE and determination of the arc flash boundary.

3.3.5 ARC FLASH & SHOCK APPROACH BOUNDARIES

Qualified Electrical Workers (QEWs) who cannot establish an Electrically Safe Work Condition and are required to work within the Arc Flash Boundary or Restricted Approach Boundary shall:

- be appropriately qualified for the work task,
- conduct a Job Hazard Assessment (JHA) and/or utilize approved work procedures,
- wear appropriate arc flash and shock PPE for the work task,
- utilize insulated hand tools and equipment rated to exceed maximum exposed voltage,
- utilize a QEW as a safety watch where required, and
- complete an Energized Electrical Work Permit and FLHA as required.

Non-electrical workers (NEW's) shall not be permitted to approach within the Arc Flash Boundary or Limited Approach Boundary unless wearing appropriate PPE, a QEW advises them of the possible hazards, and continuously escorts them while inside the boundary. Non-electrical workers are not permitted within the Restricted Approach Boundary at any time.

To safely route non-electrical workers, equipment or objects under power lines or Energized Conductors, the minimum distance may be reduced under the direction of a Qualified Electrical Worker; however, the clearances for workers, equipment or objects shall remain constant.

3.3.6 ELECTRICAL WORK ZONE

An Electrical Work Zone shall be established for energized electrical work tasks using a suitable barrier to prevent unauthorized access to all entry points to the zone. The Electrical Work Zone shall be established at the Limited Approach Boundary or the Arc Flash Boundary whichever is further away (minimum 10ft. or 3m to ensure adequate work space is provided). Suitable barriers include temporary plastic tape (e.g. red 'Danger' Tape, plastic stanchions with retractable tape, magnetic or permanently mounted retractable tape, other appropriate barricades or fencing). Temporary barriers are not required where unauthorized access to the Electrical Work Zone is prevented by building walls and doors.

The Electrical Work Zone can only be crossed by authorized QEW's. Other workers, not qualified and authorized, shall not cross the Electrical Work Zone boundary unless approved by the

authorized and Qualified Electrical Worker and shall be 100% accompanied by the Qualified Electrical Worker when inside the Electrical Work Zone. When other workers are inside the Electrical Work Zone, they shall be wearing the same PPE as the Qualified Electrical Worker. Other unqualified workers shall not cross the Restricted Approach Boundary for Shock at any time.

Where the use of barriers is not deemed to be practical (e.g. High Voltage Substations, Transmission and Distribution Overhead Lines, etc.), a Qualified Electrical with high voltage training must be used as a Safety Watch. The Safety Watch controls access to the electrical work area. In some cases, a third worker may be required to perform the role of the Safety Watch. All energized electrical work must be completed, and the permit closed prior to removing any barriers and/or the Qualified Electrical Safety Watch. A safe electrical work zone must be maintained for the duration of all energized electrical work tasks.

3.4 ELECTRIC SPECIFIC PPE, TOOLS AND EQUIPMENT

Workers performing tasks in areas where there is potential electrical hazard shall use, personal protective equipment, safety tools and equipment that are appropriate for the task.

All electrical specific PPE, tools & equipment shall be of a safe design and construction for the task they are to be used. They must meet and/or be certified to all applicable Standards including CSA, UL, ULC, ANSI, IEEE or ASTM. When required they must be suitably marked indicating approval ratings and test dates as applicable.

Electric specific PPE, tools and equipment must be inspected for visual defects prior to use to ensure it is inscribed with appropriate certification marks, fit for use and that it has a sticker or tagging that indicates it has been tested, where applicable.

If there is any doubt as to the safety or integrity of electric specific PPE, tools and equipment, it must be discarded and replaced with new and/or tested equipment.

3.4.1 ELECTRICAL PPE

As a minimum, the THREE Level PPE system as indicated in Figure 2 below shall be implemented for all work with energized electrical equipment and system at all LP facilities.

<h2 style="margin: 0;">ARC FLASH PPE GUIDE</h2> <p style="margin: 0; font-size: small;">Guidance on Selection of Arc-Rated Clothing and Other PPE for Use When Incident Energy Exposure Is Determined For more detailed information on other options, refer to NFPA 70E Table 130.3(D) or CSA 2462 Table 2</p> <p style="margin: 0; font-size: x-small;">FR/Arc-rated PPE for electrical workers shall meet the minimum ATPV of 8 cal/cm² and increase as required by incident energy value. Workers shall wear undergarments made with a natural fiber (e.g., cotton, wool, or silk).</p>		
<p style="text-align: center;">LEVEL 0</p> <p style="text-align: center;">Incident Energy Exposure <1.2 cal/cm²</p>	<ul style="list-style-type: none"> FR/Arc-rated Long Sleeve Shirt and Pants or FR/Arc-rated Coveralls (FR/Arc-rated Jacket, Pants or Rainwear as req'd for Weather) Hard Hat Safety Glasses Heavy Duty Leather Work Gloves Leather Ohm Rated or EH Rated Footwear 	
<p style="text-align: center;">LEVEL 1</p> <p style="text-align: center;">Incident Energy Exposure ≥1.2 cal/cm² – 12 cal/cm²</p> <p style="text-align: center; font-size: x-small;">Arc-rated clothing and equipment with an arc rating equal to or greater than the determined incident energy.</p>	<ul style="list-style-type: none"> FR/Arc-rated Long Sleeve Shirt and Pants or FR/Arc-rated Coveralls (FR/Arc-rated Jacket, Pants or Rainwear as req'd for Weather) Hard Hat Hearing Protection Safety Glasses Arc-rated Face Shield and Arc-rated Balaclava Rubber Insulating Gloves with Leather Protectors Leather Ohm Rated or EH Rated Footwear 	
<p style="text-align: center;">LEVEL 2</p> <p style="text-align: center;">Incident Energy Exposure >12 cal/cm²</p> <p style="text-align: center; font-size: x-small;">Arc-rated clothing and equipment with an arc rating equal to or greater than the determined incident energy.</p>	<ul style="list-style-type: none"> Arc Flash Suit: Arc-rated Arc Flash Suit Hood with Head Protection, Arc-rated Jacket, and Arc-rated Pants or Coverall (Bib Overall Recommended) Safety Glasses Hearing Protection Rubber Insulating Gloves with Leather Protectors Leather Ohm Rated or EH Rated Footwear 	

Figure 2 - Three Level PPE System

1. Flammable synthetic materials may not be worn under Arc Rated (AR) clothing as they can melt to the skin in an Arc Flash. Excluding AR garments, this includes acetate, acrylic, nylon, polyester, polyethylene, polypropylene and spandex, either alone or in blends.
2. Rubber Insulating gloves complete with leather protectors provide increased arc flash protection due to the increase in material thickness.

Rubber Insulating Glove classes:

- Class 00 up to 500V AC/750V DC
- Class 0 up to 1,000V AC/1,500V DC
- Class 1 up to 7,500V AC/11,250V DC

Uncontrolled Copy if Printed or Downloaded

Internal Information

- Class 2 up to 17,000V AC/25,500V DC
 - Class 3 up to 26,500V AC/39,750V DC
 - Class 4 up to 36,000V AC/54,000V DC
3. At a minimum, non-conductive safety glasses complete with side-shields shall always be worn under a face shield or Arc-Rated Arc Flash Suit Hood.

3.4.2 ELECTRICAL TOOLS & EQUIPMENT

Electrical tools and equipment provided by contractors must meet and/or be certified to all applicable Standards for the task they are to be used for and be selected, stored, used and maintained in accordance those standards.

3.5 ENERGIZED ELECTRICAL SAFE WORK PRACTICES

To perform energized electrical work tasks, the following principles as preventive and protective control measures to protect personnel from electrical hazards shall be followed:

- Plan the work, and then work the plan.
- Do not rush when planning or carrying out the electrical work task.
- All near misses and electrical incidents (e.g. arc flash and shock) shall be reported immediately to the Company. These incidents should be fully investigated, lessons learned recorded, and recommendations communicated and implemented.
- No worker should begin any electrical work until the worker fully understands the instructions received and in no circumstances should that person exceed or abstain from following those instructions. Should any person consider that the instructions given cannot be carried out safely, that worker should refer the matter immediately to an appropriate Supervisor.
- No worker shall interfere with temporary protective grounding or other grounding connections, locks, tags, danger or warning signs, safety barriers, flags or other safety devices.
- Stand away from the front and to the side of a circuit breaker or disconnect switch when opening or closing it under normal operating conditions. Whenever possible, use remote racking or remote switching
- Only use tools that are appropriately insulated and approved.
- Test every circuit, every conductor, every time, before you touch. Use the TEST-BEFORE-TOUCH procedure.
- Do not work on any electrical conductors or circuit parts where the area is damp or wet until the area is cleaned and dried.

- Fixed or portable Class 'A' GFCI's shall be used for all portable cord-and-plug-connected electrical equipment used outdoors, and in process areas indoors and outdoors regardless of the power source.
- Prior to using portable cord-and-plug-connected electrical equipment and extension cords, they shall be visually inspected for damage such as cracked insulation, broken plug, signs of burns etc. All damaged portable electrical equipment and extension cords shall be tagged as 'Damaged - Do Not Use' and be repaired by a QEW or discarded.
- Be aware of the potential for DC shock and arc flash (e.g. from battery systems or other DC systems).
- All portable ladders used near energized electrical equipment shall have non-conductive side rails.
- Conductive articles (e.g. clothing or jewellery) are not permitted to be worn while conducting energized electrical work.
- If lighting is not adequate to perform work tasks safely, temporary work task lighting shall be used.
- Adequate workspace shall be provided around electrical equipment to conduct work tasks safely, as per *CEC Rule 2-308* or *NEC 110.26(A)*.
- There shall be sufficient space provided around electrical equipment and work areas for unobstructed access and egress in emergency situations, as per *CEC Rule 2-310* or *NEC 110.26(C)*.
- Temporary power equipment shall be installed to minimum safe installation standards, including grounding of temporary generators. A Temporary Power Certificate is required to be completed by the Company for all temporary power installations. This may be done in consultation with the Contractor
- When performing energized electrical work, look-alike equipment shall be identified with a visual alerting technique (e.g. Danger or Warning tape) to prevent access.
- Non-Electrical Workers may only perform demolition work after the equipment has been de-energized in accordance with this specification .
- Electrical work shall not be performed if the worker is not fit for work.
- If the scope of the work task changes, work shall be stopped, the overall Field Level Hazard Assessment (FLHA) will be completed over again and any appropriate changes identified and implemented.

- Appropriate precautions should be taken if an electrical work task is completed in a confined space.
- During the execution of a work task, if any changes are noticed from the planned procedures then immediately stop the task, think and analyze, assess the hazard and risk, mitigate the risk, and then resume work.
- Workers shall receive training on emergency response to electrical incidents and emergency release of shock victims where applicable by their job description (see 3.11 below).

3.6 HIGH VOLTAGE SUBSTATIONS

Only Company Qualified Electrical Workers with high voltage training are authorized to perform switching and isolation procedures and related operations and maintenance work tasks on Company owned high voltage substation equipment and power systems.

Note: Work activities should not be performed on substation equipment and power systems when lightning is in the area or when passing over lines exiting the facility. Additional precautions are needed if precipitation is present.

The Company's Electrical Equipment Work Isolation and Clearance form must be utilized for any isolations required of Company owned high voltage substation equipment or power systems when:

- work activities are being performed by Company or its Contractors on the Company's high voltage substation equipment and power systems
- work activities are being performed by a 3rd party to Company on a Utility System Owners or Operators interconnected high voltage substation equipment or power systems. For the purpose of the requirements of this section, 3rd parties to Company include the Utility System Owner or Operator and their Contractors.

A Qualified Electrical Worker with high voltage training will be assigned as a Lead for all electrical work in substations. The lead will:

- Assure contractors working under their direction comply with the requirements of this standard; and
- Maintain all required records;
- As far as reasonably possible prevent unauthorized persons from approaching places where work is being done and hazardous conditions exist by the use of Danger tape, barricades, Electrical Safety Watch;
- Prohibit the use of any tools or devices unsuited to the work. All tools and equipment entering the substation or an area 3m (10ft) of exposed energized conductors or circuit parts are to be inventoried and discussed in a job briefing/tailboard meeting prior to the work being performed in the electrical safe work area.

Qualified Electrical Workers with high voltage training working under the direction of a designated Lead will be responsible for:

- working safely on energized electrical equipment or lines;
- Undertake all maintenance work tasks assigned to them by the designated Lead; and
- If it is an emergency can perform work tasks without first receiving authorization of the designated Lead.

Accessing Substations for Electrical Work

Before accessing a high voltage substation, a Qualified Electrical Worker with high voltage training must complete an FLHA. The following general rules and policies apply with respect to access to the high voltage substation:

- Qualified Electrical Workers with high voltage training are authorized to enter the substation. Any other worker shall be escorted and supervised at all times by the authorized Qualified Electrical Worker.
- When energized electrical work is completed in the high voltage substation at a minimum two (2) Qualified Electrical Workers with high voltage training are required. One of the Qualified Electrical Workers will be designated as the Lead Qualified Electrical Worker in charge for executing the assigned work task.
 - Required work shall be completed with the use of switching diagrams and 5kV one-lines, showing the arrangement and location of electrical equipment and lines.
 - Procedures and or Job Hazard Assessments (JHA's) will be used for the operation, isolation and maintenance of electrical equipment and lines.
 - Procedure shall be used outlining the application and use of temporary protective grounding that ensures that Qualified Electrical Workers working on isolated and grounded electrical equipment or lines are not subjected to hazardous potentials. The procedures detail the steps necessary to safely apply temporary protective grounds to isolate the high voltage circuitry and temporary ground the circuit being worked on to eliminate hazardous potential voltages.
 - The Qualified Electrical Workers must ensure that switching diagrams or equivalent devices, operating procedures and procedures outlining the application and use of temporary protective grounding are kept up-to-date at all times.

- When maintenance work tasks are required to the substation that are not energized work tasks, but relate to snow removal or over growth management or other similar non-electrical maintenance tasks (e.g. painting) a Qualified Electrical Worker with high voltage training must instruct the Non-Electrical Workers on the Limits of Approach or Minimum Approach Distances and will directly supervise the work as it is completed.
- Qualified Electrical Workers will adhere to the appropriate Limits of Approach or Minimum Approach Distances at all times when inside the energized high voltage substation and related to authorized energized electrical work.
- If any “Abnormal Conditions” occur while a Qualified Electrical Worker is inside the energized high voltage substation, they would evacuate the substation and muster at the approved muster point and contact the Company Operator-in-Charge.
- The established Risk Assessment Process/Procedure shall be followed before energized electrical work tasks are executed. Special approvals are required for “High Risk” work tasks.
- An Energized Electrical Work Permit (EEWP) is required before the energized electrical work task is executed.
- Make sure that you can be seen when around vehicles. Do not stand under lifted loads, buckets etc.
- Ensure portable equipment and vehicles are properly bonded and grounded as required.
- Be aware of the risk of Injury or damage to health from the mechanical components of the switching & isolation devices.
- Ensure bonding of metal grating and operating switches before touching or operating the switch.
- Electrical Specific PPE, Tools & Equipment used in energized high voltage substations shall be made of non-conductive material selected, inspected and approved for the work task.
- Do NOT use metal ladders, wooden ladders, metal measuring tapes, ropes, hand lines, metal hard hats or similar equipment constructed of metal, or with metal strands in the fabric. This equipment is PROHIBITED from entering the Substation.
- Electrical Specific PPE, Tools & Equipment will be one method of preventive and protective controls applied to reduce risk of exposure to shock and arc flash.
- Never carry anything over your shoulders.
- Ask for help if you have to carry something that is awkward.

- Do not rush. Plan every move and only work according to the plan and written procedure.
- Arms are to be kept below shoulder level when working around energized substation equipment.
- Look up and check the equipment before you start to work around it. Check for broken risers, broken porcelain or anything that is in an abnormal condition.

3.7 WORKING ALONE

Prior to assigning work, a determination must be made if working alone is acceptable. When working alone is authorized, the Worker and Contractor Supervisor must establish a means of communication and assistance.

3.8 LOOK ALIKE EQUIPMENT

In order to avoid the hazard and associated risk of working on the wrong equipment, Contractor Qualified Electrical Workers should consider placement of temporary warning signs or use tape or ribbons on any look alike equipment in close proximity to the work area. This will alert the worker of the hazard of the look alike equipment and reduce the risk of inadvertently attempting to work on it or access it while in an energized state.

3.9 TEMPORARY POWER SYSTEMS

When temporary power distribution systems are required during construction, facility shutdowns, or when the normal power system is not available to source power, precautions are to be taken to ensure that the installed temporary power distribution systems do not expose workers to the electrical hazards of arc flash and shock.

At a minimum the requirements of *Section 76 of the CEC Part 1* and *NEC Article 590* shall be met for any temporary power distribution system(s).

Temporary power distribution systems require a Company Temporary Power Certificate to be completed and should be kept in service for the shortest time possible and must be inspected every 90 days. Maximum duration should not exceed one year. If the timeframe is to be extended, then the entire power distribution system must be inspected and re-approved and a new Temporary Power Certificate issued.

Where portable power generators are used, they shall be installed to the manufacturer's requirements and bonded to ground.

All equipment used in the temporary power distribution system shall be protected by suitable barriers so that vehicles and other construction or maintenance equipment do not damage it and expose workers to arc flash and shock.

Temporary power distribution cables shall be protected from damage by ensuring they are routed away from high traffic areas. Where this is not possible, mechanical protection must be provided (e.g. wooden covers, plastic cable troughs, pipe, suspended above ground, etc.). When cables are suspended above ground ensure they are high enough to avoid encroachment by vehicles or other construction equipment or routed where vehicles are not permitted to go. Signalling with tape and flags may be required for cables that are suspended above ground.

If insulated temporary power cables have to be routed across roads as an additional precaution, they must be routed high enough to avoid encroachment by vehicles into the Limited Approach Boundary for movable conductors in *CSA Z462 Table 1A or 1B* or *NFPA 70E Table 130.4(D)(a) or Table 130.4(D)(b)*.

All temporary power distribution equipment must be suitably bonded to ground.

Before energizing the temporary power distribution system, the electrical protective devices used shall be checked to ensure that the disconnect switches, circuit breakers, fuses and relays are in good condition and suitably rated for the duty.

When energized electrical work is required to be performed on temporary power distribution systems the electrical risk assessment requirements of this standard are required to be completed.

3.10 ELECTRICAL INCIDENTS AND REPORTING

Contractors shall report all electrical incidents to the Company and the authority having jurisdiction over the Contractor as per the applicable requirements.

An electrical incident is defined as any of the following:

- Any incident where a person is injured by an Electrical Shock, Arc Flash, or associated Arc Blast;
- Any incident where electrical equipment fails in a manner that did or could have reasonably been expected to injure a person, damage equipment, or result in production loss;
- A near miss for any of the above.

It is a policy of this ESS that:

- All electrical shocks, no matter what voltage level shall be reported.
- All arcing faults and arc flash events shall be reported.

Electrical incidents shall be investigated in accordance with the requirements of the Incident Investigation Specification.

3.11 ELECTRICAL EMERGENCY RESPONSE

Workers exposed to electrical hazards are to be trained in methods of release of victims from contact with exposed energized electrical conductors or circuit parts. This should include emergency isolation procedures and the use of approved insulating or insulated PPE and tools (e.g. hot stick).

Only those workers authorized to do so and with proper training shall undertake electrical emergency response rescue.

Where required, a Safety Watch assigned to electrical work should have an approved fire extinguisher for electrical fires, working radio or access to a phone for communication, and a working flashlight available. A rescue stick, shepherds stick or hot stick and rubber insulating gloves may also be required for certain applications (e.g. during execution of High Risk energized electrical work etc.). If emergency lighting is installed it shall be checked to ensure it is functional.

Never attempt to rescue a victim of an electrical incident without de-energizing the electrical system first or suitably protecting the person that would attempt to rescue the victim!

The risk of exposure to electrical hazards shall be eliminated before rescue is attempted. *The Methods of Release* section below identifies approved methods that authorized workers can use to rescue a shock victim when they are working on electrical power distribution equipment.

3.11.1 METHODS OF RELEASE

Approved methods of release shall be utilized by the authorized worker completing the rescue, the three methods available are:

- Turn off the power by identifying the Main Breaker and opening it;
- Rescue the victim using a rescue stick, shepherd's stick, or hot stick;
- Use rubber insulating gloves and ensure that the rescuers' body doesn't make contact with the victim, only the hands.

Note: Other methods such as using wood, running tackle or throwing an object at the victim are not approved for use; they may expose the rescuer or the victim to additional hazards.

4.0 REFERENCES

CANADA:

Canada Occupational Health and Safety Regulations (SOR/86-304 Part VIII – Electrical Safety)

Applicable Provincial Occupational Health and Safety Codes

CAN/CSA-C22.1 Canadian Electrical Code (CEC) Part 1

CAN/CSA-C22.3 No. 1 Overhead Systems

CAN/CSA-C22.3 No. 7 Underground Systems

CSA Z462 Workplace Electrical Safety Standard

CSA Z463 Maintenance of Electrical Systems Standard

CAN/ULC S801 Standard on Electric Utility Workplace, Electrical Safety for Generation, Transmission and Distribution Alberta Electrical Utility Code (AEUC)

USA:

29 CFR 1910.269 Occupational Safety and Health Standards, Subpart R – Special Industries, Electrical Power Generation, Transmission and Distribution

29 CFR 1910.301-399 Occupational Safety and Health Standards, Subpart S – Electrical

29 CFR 1926.400-449 Safety and Health Regulations for Construction, Subpart K – Electrical

NFPA 70 National Electrical Code (NEC)

NFPA 70B Recommended Practice for Electrical Equipment Maintenance

NFPA 70E Standard for Electrical Safety in the Workplace

APPENDIX

APPENDIX A – ELECTRICAL WORK TASKS BY QUALIFICATION CATEGORY

Category	Sub-Category	Authorized Work Tasks	Conditions/ Limitations
Qualified Electrical Worker (QEW) – Low & High Voltage	Minimum Journeyman Electrician– Canada *Exception: Unless not required in a jurisdiction and approved by the Company Regional Director/ Project	Work on low voltage equipment. Work on de-energized high voltage systems. Work on energized high voltage systems including high voltage switching, metering, and relay protection and communication system related work tasks.	Specialized technical skills training is required for work on high voltage equipment. Non-journeyman electricians shall have demonstrated skills and knowledge related to the construction, commissioning, operation and maintenance of electrical equipment. For Contractors – work on Energized systems require prior Company approval
	Qualified Electrician – USA	Work on low voltage equipment. Work on de-energized high voltage systems. Work on energized high voltage systems including high voltage switching, metering, and relay protection and communication system related work tasks. Work on 2,300V – 230,000V high voltage substation equipment involving operation of high voltage circuit breakers or circuit switchers.	Shall have demonstrated skills and knowledge related to the construction, commissioning, operation and maintenance of electrical equipment. Specialized technical skills training is required for work on high voltage equipment. For Contractors – work on Energized systems require prior Company approval

Category	Sub-Category	Authorized Work Tasks	Conditions/ Limitations
Qualified Electrical Worker (QEW) – Continued	Electrical Engineers & Electrical Engineering Technologists	Electrical acceptance and testing work tasks on low or high voltage systems.	<p>Shall have demonstrated skills and knowledge related to the construction, commissioning, operation and maintenance of electrical equipment.</p> <p>Specialized technical skills training is required for work on high voltage equipment.</p> <p>For Contractors – work on Energized systems require prior Company approval</p>
	Power Line Technicians	Work on de-energized and energized high voltage systems.	For Contractors – work on Energized systems require prior Company approval
Associate Electrical Worker (AEW)	<p>Apprentice Electrician – Canada</p> <p>Electrician in Training – USA</p>	Work on low voltage and high voltage equipment as required, under direct supervision of a Qualified Electrical Worker.	<p>Worker shall be adequately trained and validated as competent.</p> <p>Work tasks shall be approved by and under the direct supervision of a Qualified Electrical Worker.</p> <p>Specialized technical skills training is required for work on high voltage equipment.</p> <p>For Contractors – work on Energized systems require prior Company approval</p>
Category	Sub-Category	Authorized Work Tasks	Conditions/ Limitations
Task Qualified Worker (TQW)	HVAC, Fire, Overhead Door, Crane, & Cathodic Protection System Technicians	Work tasks on de-energized and energized low voltage specialized systems such as HVAC	Worker shall be adequately trained and have required knowledge and experience to work safely.

Uncontrolled Copy if Printed or Downloaded

Internal Information

Category	Sub-Category	Authorized Work Tasks	Conditions/ Limitations
		<p>systems, overhead doors, cranes and cathodic protection systems.</p> <p>Troubleshooting and diagnostic related work tasks downstream of a local disconnect.</p>	<p>The training and the certification of the worker may further limit the voltage for working on energized electrical work tasks to low voltage.</p> <p>For Contractors – work on Energized systems require prior Company approval.</p>
<p>Qualified Instrumentation Worker (QIW)</p>	<p>Instrumentation Technician</p>	<p>Work on control systems and related equipment with an operating voltage not greater than 120V AC or 125V DC.</p>	<p>For Contractors – work on Energized systems require prior Company approval.</p>
<p>Contractor Non-Electrical Workers (NEW)</p>		<p>Not permitted to do any electrical work on Company Assets</p>	<p>Shall not encroach on the Limit of Approach and Arc Flash Boundary unless required PPE worn and training and are under the supervision of a Qualified Electrical Worker.</p>

APPENDIX B – TEMPORARY PROTECTIVE GROUNDING SIGNAGE



Note: 6x10 Magnetic Sign

APPENDIX C – ELECTRICAL EQUIPMENT ISOLATION & WORK CLEARANCE FORM

	Electrical Equipment Isolation & Work Clearance Form				
SUPPORTING DOCUMENT: Form Guidance (A1)					
This form is required when providing grounds on high voltage and upstream of the 480V main breaker.				SWP#: _____	
1) PREPARATION & PLANNING					
Date of Work:	_____	Location of Work:	_____	Duration of Job: From:	_____ To: _____
Equipment Out-of-Service:	_____	Voltage:	_____	LOTO Set #:	_____
Scope of Work*: _____					
*If scope of work changes, a new form is required.					
Name of person(s) completing this form:		Affected Groups & CCO: _____			
Lockout Authority & Phone #:		<input type="checkbox"/> Work will continue on additional shifts			
2) NOTIFICATION					
<input type="checkbox"/> All affected personnel/departments have been notified					
3) EQUIPMENT NEEDED (Indicate # of each used)					
<input type="checkbox"/> lockboxes	_____	<input type="checkbox"/> personal locks	_____	<input type="checkbox"/> grounds	_____
<input type="checkbox"/> other:	_____				
4) ELECTRICAL ISOLATION & LOTO					
Isolation procedure on back >>>					
5) TEST FOR POTENTIAL					
Test Meter on Known Live Sources		Test on De-Energized Circuit		Re-Test Meter on Known Live Sources	
Location	Time	Location	Time	Location	Time
6) APPLY GROUNDS (HANG GROUNDS APPLIED SIGNS)					
Ground Sets	Location of Ground Sets & Signs			Time On	Time Off
1)					
2)					
3)					
4)					
Additional hazards and controls (if an outside service hold (guarantee) is required, provide number below):					
<input type="checkbox"/> Generators		<input type="checkbox"/> Tie Lines			
<input type="checkbox"/> Energized Issues		<input type="checkbox"/> Back Feeds			
<input type="checkbox"/> Other		<input type="checkbox"/> Switches			
7) ISSUE OF WORK CLEARANCE					
Issuer (Enbridge)	Name	Signature	Time		
Person in Charge of Work					
All other workers must sign in/out on back >>>					
8) WORK COMPLETE / PEOPLE AND TOOLS CLEAR					
<input type="checkbox"/> All work on equipment has ceased and communicated to all workers.					
<input type="checkbox"/> All personnel have been advised and tools are accounted for.					
<input type="checkbox"/> All appropriate personnel have been advised to consider equipment energized.					
9) SURRENDER OF WORK CLEARANCE					
Issuer (Enbridge)	Name	Signature	Time		
Person in Charge of Work					
10) REMOVE GROUND SETS – location(s) listed in 6) APPLY GROUNDS					
<input type="checkbox"/> Ground sets removed	Number of sets:	Signature:			
11) REMOVE LOTO AND RE-ENERGIZE					
<input type="checkbox"/> Ground sets have been removed and all areas of the form have been completed.					
<input type="checkbox"/> All locks are removed and personnel have signed off.					
<input type="checkbox"/> All equipment is restored and re-energized.					
Person Responsible for Location (or designate) – Lock Out Authority	Name	Signature	Date/Time		

APPENDIX D – ENERGIZED ELECTRICAL WORK PERMIT



Energized Electrical Work Permit

PART I: TO BE COMPLETED BY THE REQUESTER:	
(1) Description of circuit/equipment/job location: _____	Job/Work Order Number: _____
(2) Description of work to be done: _____	
(3) Justification of why the circuit/equipment cannot be de-energized or the work deferred until the next scheduled outage: _____	
Requester/Title: _____	Date: _____
PART II: TO BE COMPLETED BY THE ELECTRICALLY QUALIFIED PERSONS <i>DOING</i> THE WORK:	
(1) Detailed job description procedure to be used in performing the above detailed work: _____	
(2) Description of the Safe Work Practices to be employed: _____	
(3) Results of the Shock Risk Assessment:	
a. Voltage to which personal will be exposed _____	
b. Limited approach boundary: _____	
c. Restricted approach boundary: _____	
d. Necessary shock personal, and other protective equipment to safely perform the assigned task _____	
(4) Results of the Arc Flash Risk Assessment: _____	
a) Available incident energy at the working distance or Arc Flash PPE Category _____	
b) Necessary arc flash personal and other protective equipment to safely perform the assigned task _____	
c) Arc Flash Boundary _____	
(5) Means employed to restrict the access of unqualified persons to the work area _____	
(6) Evidence of completion of job briefing, including discussion of any job related hazards: _____	
(7) Do you agree the above described work can be done safely? <input type="checkbox"/> Yes <input type="checkbox"/> No (If No, return to requester)	
Qualified Electrical Worker: _____	Date: _____
Qualified Electrical Worker: _____	Date: _____
PART III: APPROVAL(S) TO PERFORM THE WORK WHILE ELECTRICALLY ENERGIZED:	
People Leader: _____	Date: _____
Manager: _____	Date: _____



Contractor Safety Specification

Emergency Preparedness
– Personal Safety

Table of Contents

1.0	Definitions & Acronyms.....	2
2.0	Contractor Responsibilities	2
3.0	Specification Requirements	2
3.1	First Aid.....	2
3.2	First Aid Equipment.....	2
3.3	Eyewash Stations.....	3
3.4	Automated External Defibrillator.....	4
3.5	Portable Fire Extinguishers	4
3.6	Fire Prevention and Protection.....	6
3.7	Windsocks.....	7
3.8	Boats.....	7
3.9	Medical Plan.....	8
3.10	Emergency Procedures and Evacuation Plan.....	8
4.0	References.....	8
5.0	Appendix.....	9
5.1	Boat Safety Equipment Requirements – CAN.....	9
5.2	Boat Safety Equipment Requirements – USA.....	10
5.3	Inspection Frequency for Fire Suppression Equipment	11
5.4	Maintenance Frequency for Portable Fire Extinguishers	11
5.5	Hydrostatic Test Frequency for Cartridges and Cylinders.....	12

1.0 DEFINITIONS & ACRONYMS

AED – Acronym for Automated External Defibrillator. A device that, once activated, automatically performs an analysis of the heart rhythm and, if it detects a problem that may respond to an electrical shock, permits a shock to be delivered to restore normal heart rhythm.

Enbridge—Enbridge, Inc. and Enbridge (U.S.) Inc., hereinafter will be referred to as “Company”.

ROW – Right of Way

2.0 CONTRACTOR RESPONSIBILITIES

Contractors shall:

- Ensure there are sufficient resources to effectively implement this Specification
- Perform inspections as required

3.0 SPECIFICATION REQUIREMENTS

For a complete listing of personal safety emergency response equipment requirements for all Project locations and motorized equipment please reference the Appendix of this Specification.

3.1 FIRST AID

The number of first aiders at a work location and their level of training shall be established according to local Applicable Legislation.

The requirements for medical staff and their level of qualification shall be established according to Applicable Legislation.

If a Worker is injured or wounded (e.g., cut, scrape, open wound) during water washing operations (e.g., when operating or working near a water lance), seek medical attention. Such wounds have a high risk of infection.

Wounds caused by a water lance should be treated in the same way as other wounds, except for the following steps:

- After bleeding has stopped, pour bottled or clean running water over the wound; and
- If possible, leave unclean wounds open until they have been assessed by a medical professional.

3.2 FIRST AID EQUIPMENT

All Locations and vehicles shall be equipped with first aid kits in compliance with applicable legislation.

Identification of each first aid kit shall include the words ‘FIRST AID’ or the first aid symbol.

For project locations, first aid kits shall be:

- installed in conspicuous location that is accessible at all times to all Workers; and
- Inspected monthly and re-stocked as necessary.

Posted notices shall identify the location of first aid kits. Notices shall be easily visible and posted at practical locations where Workers and Visitors will see the notice, such as:

- At building entrances;
- In and around the building or Site, e.g., in elevators, on notice boards, etc.; and
- On each Site Safety Plot Plan and/or Emergency Evacuation Plan.

A first aid manual and list of required first aid supplies shall be included inside each first aid kit.

Note that some equipment within a First Aid kit will have an expiration date.

3.3 EYEWASH STATIONS

If a worker may be exposed to chemicals that are harmful to the eyes, there must be immediate access to emergency equipment (i.e. showers, eye wash stations etc.) appropriate for the potential level of exposure.

Project Locations shall have eyewash stations available in work environments where workers may be exposed to chemical Hazards and meet the following requirements:

- Locate an eyewash station within 16.7 m (55 ft.) or 10 seconds of harmful chemicals (e.g., strong acids or caustics) or where the Hazard Assessment determines eyewash station is required.
- All types of eyewash stations shall be clearly identified and readily accessible. Do not block access; areas around the station shall be kept clear.
- Supply tepid (lukewarm) potable water for fixed plumbed systems. Placement of portable systems should consider the availability of access to potable water.
- Inspect plumbed, self-contained and portable eyewash equipment monthly. All models shall have approved nozzle caps (to prevent foreign matter buildup) and be cleaned and mounted correctly.
- For self-contained eyewash stations and unsealed portable eyewashes, change the flushing fluids quarterly, or as specified by the manufacturer. If using water, add a preservative to maintain freshness; there are commercial additives that can help prevent freezing and micro-organism build-up.
- Locate squeeze bottles close to the chemical Hazard and protect each bottle from the elements (e.g., prevent freezing).

- During inspection, ensure the eyewash equipment is clean; placed in it's a designated location. Also ensure sufficient eyewash fluid is available. When inspecting portable eyewashes, ensure the seal is not broken or past the expiry date. If expired, replace immediately or at the earliest possible date.
- Fixed eyewash stations may be plumbed into the potable water system or have a reservoir. In addition:
 - fixed eyewash stations should be mounted so the discharge nozzles are between 83.8 and 134.6 cm (33 - 53 in.) off the ground;
 - remote fixed eyewash stations that do not have a constant potable water supply shall also have an emergency eyewash station capable of providing approximately 15 minutes of continuous flushing; and
 - During each inspection of a fixed eyewash station, flush the line and verify proper operation.

3.4 AUTOMATED EXTERNAL DEFIBRILLATOR

Projects may consider placement of an AED at sites or locations, in cases where:

- The site or location has 6 or more workers; and/or
- The emergency medical response time for that location is greater than 20 minutes; and/or
- The project safety plan determines the need.

Additional AED requirements include:

- If a project is legally required to have a first aid room, an AED shall be kept in the room;
- Each AED shall be mounted on a wall or stored in a cabinet with proper signage and protective casing;
- Only Workers trained in the use of an AED are authorized to use an AED;
- AEDs are not intrinsically safe and shall not be stored in Hazardous Areas; and
- Inspect AEDs in accordance with manufacturers' specifications.

3.5 PORTABLE FIRE EXTINGUISHERS

The minimum requirement for fire extinguisher placement is as follows:

- 2 – 20 lb. ABC for any work done in Hazardous or Restricted Areas;
- 1 – 20 lb. ABC for each work area within fenced locations;
- 1 – 20 lb. ABC for each office and storage trailer;

- 1 – 20 lb. ABC for each designated outdoor smoking area;
- 1 – 20lb. ABC for each piece of Powered Mobile Equipment;
- 1 –5 lb. for ATVs and UTV;
- 1- 20 lb. fire extinguisher is mandatory within 22 m (75 ft.) of any work activity; including ROW restoration projects.

In the event that a 20 lb ABC fire extinguisher cannot reasonably be attached to smaller sized powered mobile equipment (for example riding lawn mowers or subcompact utility tractors) a 10lb or 5lb fire extinguisher can be utilized provided that:

- Other preventative measures are in place if required [for example: equipment is being used within the confines of a Company Terminal/Station providing immediate access (within 30 meters or 100 feet) to additional 30lb ABC fire extinguishers, additional fire prevention measures implemented due to dry conditions on right-of-way)]; and
- Regulatory requirements or manufacturer's specifications do not prescribe a larger fire extinguisher to be located on the specific equipment.

Each portable fire extinguisher shall cover no more than 230 m² (2500 ft²). Unless specific instructions indicate otherwise, position portable fire extinguishers so that travel distance to the extinguisher from the working area is:

- ≤ 23 m (75 ft.) for Class A fires (e.g., wood, paper);
- ≤ 15 m (50 ft.) for Class B fires (Flammable/ Combustible Liquids);
- ≤ 23 m (75 ft.) for Class D fires (metals such as sodium, magnesium, titanium).

Distances for Class C fires (electrical) are based on the surrounding fire hazards (Class A or Class B). Portable fire extinguishers for Class D hazards are required in work areas where combustible metal powders, flakes, shavings, or similarly sized products are generated at least once every two weeks.

Portable fire extinguishers shall be:

- Stored above the floor or ground (hand-held models), to prevent condensation and subsequent corrosion on extinguisher bases;
- Mounted in accordance with manufacturers' specifications when stored on vehicles or equipment, or where otherwise subjected to shock and vibration; and
- Covered for protection when placed outdoors permanently.

Project Offices shall have placement of fire extinguishing equipment based on applicable legislation, and at a minimum:

- One 10-lb to 20-lb dry chemical extinguisher inside each entrance door, rated according to the hazards in the building;
- one 20-lb CO2 extinguisher outside the entry to any room housing electronics (e.g., computer server room, UPS room, measurement room); and
- One 10-lb to 20-lb dry chemical extinguisher in the boiler room, rated according to the hazards in the room.

Worksites with ABC-rated fire extinguishers shall establish access to a supply of ABC dry chemical Extinguishing Agent. Dry chemical extinguishers stored or used outside during winter conditions should be equipped with nitrogen gas cartridges rather than carbon dioxide gas cartridges.

In the event of a fire, workers shall immediately evacuate the area and only attempt to extinguish the fire only if it is safe to do

3.6 FIRE PREVENTION AND PROTECTION

Take all necessary precautions to prevent fires, including, but not limited to, the following:

- Eliminate/control ignition sources;
- Collect and secure garbage daily until it can be properly disposed;
- Store fuels, volatile solvents or any other flammable substances in containers that are clearly labeled, approved for their contents and located in a safe place away from ignition sources;
- Ensure flammable liquid containers are electrically bonded when liquids are being transferred from one to another;
- Flammable substances and quantities of chemical in excess of that needed for one day's work shall be stored in an approved storage Facility, isolated from the actual work areas;
- Post visible signs stating "NO SMOKING OR OPEN FLAMES WITHIN 8 METERS (25 FEET) OF THIS AREA" in areas where flammable substances are stored or used;
- Guard against clothing becoming contaminated with flammable liquids ;
- Clean up spills promptly;
- Store and dispose of oily rags in approved containers of not more than 5 gallon capacity with self-closing lids designed to relieve internal pressure when subjected to fire exposure; and

- Implement other fire prevention controls based on an assessment of the Hazards.

A fire protection plan may be required based on the potential fire Hazards. Projects shall prepare a fire protection plan to prevent wildfires within or adjacent to the work areas. The plan shall contain effective prevention and control measures to address the potential for uncontrolled fires during Hot Work activities. Such measures may include the following:

- Controlling smoke and open flames;
- Controlling sparks from construction equipment and welding or grinding operations;
- Position fire suppression and other special equipment close to the Worksite and/or consulting with local fire departments about emergency response arrangements; and
- Providing fire extinguishers of appropriate size and type.

Burning shall not be permitted on Company Brownfield locations without prior authorization from the Operations Regional Manager. Greenfield burning will require Operations Regional Manager and/or Construction Manager or designate authorization. Greenfield burning is to be conducted in accordance with all regulatory requirements. When authorization to burn has been received, complete the following:

- Submit a detailed Hazard Assessment for approval prior to the commencement of burning;
- Obtain a burning permit from the Authority Having Jurisdiction prior to commencement of burning and follow Applicable Legislation;
- Provide a continuous Safety Watch for at least 1 hour after the fire is completely extinguished; and
- Supply a minimum of two 30 lb. (or 4 – 20 lb.) ABC dry chemical fire extinguishers that are readily available.

For the location of Facility fire suppression equipment, see the location's Site Safety Plot Plan.

3.7 WINDSOCKS

Position wind socks in locations that are:

- Away from wind currents caused by tanks or buildings;
- High enough to avoid influence from equipment (however, if located too high, an accurate indication of wind movement at ground level may not be possible); and
- Easily visible, day and night (e.g., illuminated locations) from the work location.

3.8 BOATS

For additional required emergency preparedness safety equipment requirements for each boat size see the Appendix of this Specification.

3.9 MEDICAL PLAN

A Medical Plan shall be established at Project Locations where access to emergency services is limited. The plan shall include:

- Directions to nearest hospital(s) and to the worksite;
- Site GPS location;
- Relevant evacuation information (such as air ambulance, nearby medical transport, etc.); and,
- Medical staff (as required).

3.10 EMERGENCY PROCEDURES AND EVACUATION PLAN

The Company Area Manager (or designate) is responsible for ensuring the Emergency Procedures, Site Safety Plot Plan and Evacuation Maps are posted in a visible location at each company Facility (i.e., main office, terminal, and pipeline maintenance shop) and Project location. All workers must be aware of where this information is located.

These procedures must include contacts for emergency services and special procedures if necessary for worksites in remote locations.

4.0 REFERENCES

Occupational Safety and Health Administration (OSHA)

- Medical & First Aid, 29 CFR 1910.151

Canada Labour Code, Part II:

- Canadian Occupational Health & Safety Regulations, First Aid, 16.1 PART XVI

ANSI Z358.1 Emergency Eyewash and Shower Equipment

Transport Canada Small Vessel Compliance Program

Federal Requirements and Safety Tips for Recreational Boats

5.0 APPENDIX

5.1 BOAT SAFETY EQUIPMENT REQUIREMENTS – CAN

Boat Size	Standard Equipment
< 6 m (19' 8")	<ul style="list-style-type: none"> • life jacket or PFD that meet the requirements in section 3.1.7.2 of the Personal Protective Equipment Specification for each person on board • buoyant heaving line at least 15 m long • reboarding device (if vertical climbing height to reboard boat from water is over 0.5 m (1' 18")) • manual propelling device or 1 anchor and at least 15 m (49' 3") of cable, rope or chain • bailer or manual bilge pump • watertight flashlight or 3 flares of type A, B, or C • sound signaling device or appliance • navigation lights (if operated in fog, after sunset, restricted visibility) - Navigation lights are only required if you operate the boat after sunset, before sunrise or in periods of restricted visibility (fog, falling snow, etc.) • 5BC fire extinguisher- Only if the boat has an inboard engine, enclosed compartments where fuel or flammable and combustible materials are stored, closed living spaces, or permanently installed fuel tanks.
> 6 m (19'8") & < 9 m (29'6")	<ul style="list-style-type: none"> • life jacket or PFD that meet the requirements in section 3.1.7.2 of the Personal Protective Equipment Specification for each person on board • buoyant heaving line at least 15m long or 1 lifebuoy attached to a buoyant line at least 15 m (49'3") long • reboarding device (if vertical climbing height to reboard boat from water is over 0.5 m (1' 18")) • manual propelling device or 1 anchor and at least 15 m (49' 3") of cable, rope or chain • bailer or manual bilge pump • watertight flashlight or 6 flares of type A, B, or C • sound signaling device or appliance • navigation lights (if operated in fog, after sunset, restricted visibility) - Navigation lights are only required if you operate the boat after sunset, before sunrise or in periods of restricted visibility (fog, falling snow, etc.) • 5BC fire extinguisher- Only if the boat has an inboard engine, enclosed compartments where fuel or flammable and combustible materials are stored, closed living spaces, or permanently installed fuel tanks. • if equipped with a heating device or cooking appliance, 1 additional 5BC fire extinguisher
> 9 m (29'6") & < 12 m (39'4")	<ul style="list-style-type: none"> • life jacket or PFD that meet the requirements in section 3.1.7.2 of the Personal Protective Equipment Specification each person on board • buoyant heaving line at least 15m long or 1 lifebuoy attached to a buoyant line at least 15 m (49'3") long • reboarding device (if vertical climbing height to reboard boat from water is over 0.5 m (1' 18")) • anchor and at least 30 m (98' 5") of cable, rope or chain • manual bilge pump or bilge-pumping arrangements • watertight flashlight • 12 flares of type A, B, C or D not more than 6 of which are type D • sound signaling device or appliance • navigation lights • magnetic compass • 10BC fire extinguisher • if equipped with a heating device or cooking appliance, 1 additional 10BC fire extinguisher

5.2 BOAT SAFETY EQUIPMENT REQUIREMENTS – USA

Boat Size	Standard Equipment
<16 ft.	<ul style="list-style-type: none"> • USCG²-approved life jacket per occupant • electric distress light or, if operating between sunset and sunrise, 3 combination (for both day/night use) red flares • Class BI fire extinguisher- Only if the boat has an inboard engine, enclosed compartments where fuel or flammable and combustible materials are stored, closed living spaces, or permanently installed fuel tanks. • sound signaling device (e.g., whistle/horn) audible for ½ mi / 4 to 6 sec • red and green navigational sidelights lights visible from at least 1 mi- Navigation lights are only required if you operate the boat after sunset, before sunrise or in periods of restricted visibility (fog, falling snow, etc.) • • an all-round white light, or a masthead light and a sternlight; all visible from at least 2 mi
>16 ft. to <26 ft.	<ul style="list-style-type: none"> • USCG¹-approved life jacket per occupant and 1 Type IV personal flotation device • orange distress flag or electric distress light, or 3 handheld or floating orange smoke signals and 1 electric distress light, or 3 handheld, meteor or parachute type combination (for both day/night use) red flares • Class BI fire extinguisher- Only if the boat has an inboard engine, enclosed compartments where fuel or flammable and combustible materials are stored, closed living spaces, or permanently installed fuel tanks. • sound signaling device (e.g., whistle/horn) audible for ½ mi / 4 to 6 sec • red and green navigational sidelights lights visible from at least 1 mi- Navigation lights are only required if you operate the boat after sunset, before sunrise or in periods of restricted visibility (fog, falling snow, etc.) • an all-round white light, or a masthead light and a sternlight; all visible from at least 2 mi

NOTES

1. Check your state and local regulations for any additional safety equipment requirements
2. United States Coast Guard

In addition, vessels operating in the State of New York also shall be equipped with an anchor and line of sufficient strength to provide the vessel with safe anchorage.

5.3 INSPECTION FREQUENCY FOR FIRE SUPPRESSION EQUIPMENT

Type of Equipment	Inspection Frequency
portable fire extinguishers (hand-held)	monthly when placed in service after repairs and use
portable fire extinguishers (wheeled)	monthly when placed in service after repairs and use
fixed systems (hydrant systems)	annually when placed in service after repairs and use
fixed systems (CO ₂ and Halon Systems)	annually (minimum) ¹ monthly (visual inspections) ² semiannually (for high-pressure cylinders) ³ when placed in service after repairs and use
foam trailers	monthly ⁴ when placed in service after repairs and use

NOTES

1. A Qualified service contractor shall inspect and test systems annually.
2. A Qualified Worker shall visually inspect systems monthly.
3. A Qualified service contractor shall inspect high-pressure cylinders semiannually. During the inspection, cylinders shall be weighed and the date of the last hydrostatic test noted. Any container that shows a loss in net content of more than 10% shall be refilled or replaced.
4. Each region/area shall assign a Qualified Worker to inspect foam trailers using the Foam Trailer Check Sheet

5.4 MAINTENANCE FREQUENCY FOR PORTABLE FIRE EXTINGUISHERS

	Maintenance Frequency	Hydrostatic Test Frequency
cartridge-type dry chemical extinguishers stored on vehicles	<ul style="list-style-type: none"> • annually • if evidence of corrosion or mechanical damage 	every 12 years
cartridge-type dry chemical extinguishers stored in buildings or outdoors	<ul style="list-style-type: none"> • annually, not to exceed 365 days • if evidence of corrosion or mechanical damage 	every 12 years
CO ₂ extinguishers	<ul style="list-style-type: none"> • conductivity test annually on all CO₂ hose assemblies • whenever evidence of corrosion or mechanical damage found on tank 	every 5 years
Rechargeable Stored Pressure Extinguishers ¹	<ul style="list-style-type: none"> • every 6 years² 	every 12 years
Halon stored pressure extinguishers	<ul style="list-style-type: none"> • if evidence of corrosion or 	every 12 years

	mechanical damage	
liquid-charged AFFF foam extinguishers	<ul style="list-style-type: none"> every 3 years if evidence of corrosion or mechanical damage 	every 5 years
wheeled fire extinguishers	<ul style="list-style-type: none"> annually if evidence of corrosion or mechanical damage 	every 12 years

NOTES

1. Non-rechargeable stored pressure extinguishers are not internally inspected or hydrostatically tested. These extinguishers are removed from service at a maximum interval of 12 years from the date of manufacture, or sooner when exhibiting signs of corrosion or mechanical damage.
2. Rechargeable stored pressure extinguishers shall be emptied and subjected to the applicable internal examination procedure as outlined in the manufacturer service manual and NFPA 10.7.3.

5.5 HYDROSTATIC TEST FREQUENCY FOR CARTRIDGES AND CYLINDERS

Cartridge/Cylinder	Hydrostatic Test Frequency
nitrogen cartridges on hand-held extinguishers	exempt (CAN), every 10 years (USA)
Ansul CO ₂ cartridges on hand-held extinguishers	exempt
nitrogen cylinders on wheeled fire extinguishers	every 5 years

<End of Document>



Contractor Safety Specification

Environmental Conditions

Table of Contents

1.0	Definitions & Acronyms.....	2
2.0	Contractor Responsibilities	2
3.0	Specification Requirements	2
3.1	Lightning.....	3
3.2	High Wind Events	3
3.3	Heavy Snow	3
3.4	Heavy Rain.....	4
3.5	Extreme Heat/Heat Stress	5
3.6	Extreme Cold	5
3.7	Journey Management	5
3.8	Working Alone.....	6
3.9	Working after Sunset and Before Sunrise.....	8
3.10	Sanitary Facilities	8
4.0	Appendix	9
4.1	Table 1-Heat Index from Temperature and Relative Humidity Readings.....	9
4.2	Table 2 -Correction Factor (in °F) for Radiation Heat, Clothing, and Workload	10
4.3	Table 3-TLVs Work/Warm-up Schedule for Outside Workers based on a 4-Hour Shift.....	11

1.0 DEFINITIONS & ACRONYMS

Enbridge—Enbridge, Inc. and Enbridge (U.S.) Inc., hereinafter will be referred to as “Company”.

IDLH—Acronym for immediately dangerous to life or health. This is an atmospheric concentration of any toxic, corrosive or asphyxiate substance that would pose an immediate threat to life; would cause irreversible or delayed adverse health effects; or would interfere with a worker's ability to escape from a dangerous or hazardous atmosphere.

PPE—Personal protection equipment

ROW—Right of way

SCBA—Supplied air breathing apparatus

TLV—the threshold limit value of a chemical substance is a level to which it is believed a worker can be exposed day after day for a working lifetime without adverse effects.

UV—Acronym for ultraviolet radiation that is defined as that portion of the electromagnetic spectrum between X-rays and visible light or between 40 and 400 nanometer (nm) wavelengths. The primary source of UV radiation is the sun. There are also a number of artificial sources, such as tanning booths, welding and halogen lights. The different sources come with some unique hazards, depending on the wavelength range of the emitted UV radiation.

2.0 CONTRACTOR RESPONSIBILITIES

Contractor shall:

- Provision sufficient resources to effectively implement this Specification, and
- Ensure work is postponed, altered or shutdown as required by environmental conditions.
- Be knowledgeable in the requirements and expectations of this Specification, and
- Be able to recognize the signs and symptoms of cold and heat stress.

3.0 SPECIFICATION REQUIREMENTS

The safe work permit issuer shall check weather reports prior to issuing and approving permits. Permits suspended due to inclement weather shall be revalidated once weather conditions improve.

If potential or imminent severe weather is forecast, the hazards due to severe weather need to be identified and controls implemented. Controls can include, but are not limited to:

- Having workers work remotely;
- Sending workers home from Company locations to avoid travel in severe weather,
- Closing offices and worksites;

- Sheltering in place; and
- Suspending work until inclement weather has passed.

3.1 LIGHTNING

Take appropriate shelter when thunder is heard or lightning is seen; outside work shall not recommence until 30 minutes after the final observation of thunder or lightning.

Where practicable, use lightning detectors to supplement visual and auditory detection of electrical storms; use the detector's specifications to determine detection ranges and action plans.

3.2 HIGH WIND EVENTS

Stand clear of roadways or train tracks because a gust may blow you into the path of an oncoming vehicle. Use handrails where available on outdoor walkways, and avoid other elevated areas, such as roofs, without adequate railing. Watch for flying debris. Tree limbs may break and street signs may become loose during strong wind gusts. Keep an eye toward nearby balconies for loose objects that may fall.

If driving, pull your vehicle off the pavement as far as possible, stop and set the emergency brake. If you can't pull off the roadway, proceed at a speed suitable for visibility, turn on lights and sound horn occasionally. Use the painted center line to help guide you. Look for a safe place to pull off the roadway. Never stop on the traveled portion of the roadway.

When wind conditions exceed 50 km/hr (30 mph) or more, the Hazard Assessment shall be reviewed and adjusted to take the wind conditions into consideration, or the activity shall be suspended until wind conditions are more favorable. Consider other Hazards such as dust and debris, secure any loose materials

Refer to the Hoisting and Rigging Specification for considerations when performing hoisting and rigging operations in high winds.

In the event of a tornado, an underground area provides the best protection from a tornado. If an underground shelter is unavailable, consider doing the following:

- Seek a small interior room or hallway on the lowest floor possible;
- Stay away from doors, windows and outside walls;
- Stay in the center of the room, and avoid corners because they attract debris; and
- Choose a room constructed with reinforced concrete, brick or block; with no windows; and with a heavy concrete floor or roof system overhead.

3.3 HEAVY SNOW

To prevent slips, trips and falls, clear snow and ice from walking surfaces as quickly as possible after a winter storm. When walking on snow or ice is unavoidable, workers should be trained to:

- Wear footwear that has good traction and insulation (e.g. insulated and water resistant boots or rubber over-shoes with good rubber treads), and
- Take short steps and walk at a slower pace to react quickly to changes in traction.

When driving in heavy snow, drive below posted speed limits because they are intended for ideal driving conditions. Other best practices include:

- Be alert. Black ice will make a road look like shiny new asphalt. Pavement should look grey-white in winter;
- Do not use cruise control. Winter driving requires you to be in full control at all times;
- Reduce your speed while approaching intersections covered with ice or snow;
- Allow for extra travelling time or delay a trip if the weather is inclement;
- Drive with low-beam headlights on. Not only are they brighter than daytime running lights but turning them on also activates the tail lights. This lighting makes your vehicle more visible;
- Lengthen your following distance behind the vehicle ahead of you. Stopping distance on an icy road is double that of stopping on a dry one. For example, when driving at the speed of 60km/h (37.3mph) stopping distance is from around 45 metres (140ft.), which increases to 80metres (over 260ft.) on an icy road surface;
- Steer with smooth and precise movements. Changing lanes too quickly and jerky steering while braking or accelerating can cause skidding;
- Be aware and slow down when you see a sign warning that you are approaching a bridge. Steel and concrete bridges are likely to be icy even when there is no ice on the ground surface (because bridges over open air cool down faster than roads which tend to be insulated somewhat by solid ground);
- Consider getting off the road before getting stranded if the weather is worsening;
- Keep a safe distance back from snow plows and salt/sand/anti-icing trucks; and
- Never pass a snow plow due to whiteout conditions and ridge of snow created by the plow.

3.4 HEAVY RAIN

Avoid driving on flooded access roads or ROWs, and avoid crossing bridges if water level is high and fast flowing. Stay out of trenches, excavations, flood zones/plains and below ground level unsheltered entry points.

Take cover during hailstorms and expect slippery walking and driving conditions. Be aware of possible damage to trees and power lines due to ice buildup and avoid travel in these conditions.

3.5 EXTREME HEAT/HEAT STRESS

Consult the climatic condition reports from your local weather service during field level hazard assessment, and apply the correction factor, and repeat the Hazard Assessment Process whenever conditions change (see Table 1 APPENDIX).

Determine the amount of cloud cover; the exertion level of the work being conducted and the type of clothing being worn to calculate the correction factor (see Table 2 APPENDIX). To accomplish this, follow the best practices below where applicable:

- Reduce the physical demands of work (e.g., excessive lifting);
- Provide shade and recovery areas (e.g., air-conditioned enclosures, rooms for rehydration);
- Use shifts (e.g., early morning, cool part of the day, night work);
- Use relief workers;
- Use worker pacing;
- Take steps to protect workers from exposure to UV radiation such as sunscreen, PPE, and clothing with UV protection and wide brims;
- Assign extra workers, limit worker occupancy or the number of workers present, especially in confined or enclosed spaces;
- Train workers to recognize the signs and symptoms of heat stress; and to know and follow heat stress prevention measures; and
- Provide water nearby on the Worksite (Workers should drink about one cup of water every 20 to 30 minutes, even if they are not thirsty).

3.6 EXTREME COLD

Wear layers of warm clothing and cover as much exposed skin as possible. Ensure workers are able to recognize signs and symptoms of cold related conditions in other workers. Take 10 minute warm up breaks as required by Table 3 (see APPENDIX), calculating for wind chill (Note that these TLVs are applicable to workers in dry clothing).

3.7 JOURNEY MANAGEMENT

Contractors that may be travelling as part of their role shall develop a Journey Management Plan when workers are travelling more than 2 continuous hours. The plan shall include:

- Contact information and travel schedule (identifying the route, timeline of travel and stops to be made);
- Emergency contacts and emergency response guidelines;
- Communication frequency and method of communication;

- Weather and travel considerations; and
- Changes to travel plans.

If the Workers journey is hindered by weather or other emergencies, the individual's first priority should be to move to a safe location, contact emergency personnel if necessary, then contact his or her supervisor as soon as reasonably possible.

3.8 WORKING ALONE

Working alone practices shall be developed for Company locations. The practices shall include considerations for both normal and unexpected work situations.

This includes workers required to travel alone to remote locations or where there is no routine interaction with other people. Working alone practices shall include, but not be limited to:

- Specific controls for identified hazards,
- Effective communication devices/systems;
- An escalation strategy for when contact with a worker is lost;
- Rules setting out types of work that cannot be completed while working alone, including, but not limited to:
 - Confined Space Entry work;
 - Certain High Voltage electrical work (see Electrical Safety Specification);
 - Open System work;
 - Energized substation work;
 - Work in excavations;
 - Where personal fall protection is required;
 - Working with quick acting toxic materials [identified by the Safety Data Sheet (SDS)];
 - Using supplied air equipment or SCBA;
 - Work involving a risk of drowning;
 - Work on equipment that cannot be locked out once a guard or other safety mechanism is removed; and
 - Operation of any motorized or manual materials handling equipment where a spotter is required.

The practices shall also ensure that workers do not work alone unless appropriate safety precautions are taken, which may include but are not limited to:

- Personal Atmospheric Monitoring,

- Protection from weather conditions; and
- Frequent communication at specific intervals.

Workers shall not work alone in conditions that are or may be considered Immediately Dangerous to Life and Health (IDLH).

The hazard assessment shall determine:

- The hazards for each type of work being performed;
- The hazards for each worksite where workers will potentially work alone;
- The length of time the worker is out of contact; and
- Factors and considerations to ensure the availability of help.

Working alone controls may include, but are not limited to:

- “Man down” or lone worker alarm or pendant;
- Provision for emergency rescue and first aid;
- Frequent “check-ins” with a designated contact person that:
 - Are visual or two way contacts (or, a one-way system may be acceptable if it allows the worker to call or signal for help and will send a call for help if the worker does not reset the device after a predetermined interval);
 - Are of a frequency not to exceed 2 hours (in some cases the duration could be shorter based on the hazard assessment); and
 - Activates the escalation strategy if contact cannot be made, or there are unusual delays in re-establishing contact.

Effective means of communication include, but are not limited to:

- Portable or cell telephone;
- Walkie-talkie;
- Personal alarm;
- Periodic site visits;
- Electronic methods, such as online web applications;
- Check-in system and requirement for updating an individual’s status while working alone;
- GPS-based communication device (e.g., SPOT Messenger); and
- Use of software or hardware to assist with communication in circumstances of poor network coverage.

3.9 WORKING AFTER SUNSET AND BEFORE SUNRISE

Work after dusk shall not be permitted unless the following conditions are met:

- For Contractor work, prior approval shall be obtained from the Company Representative;
- There is a minimum of two (2) workers, or communications exist to outside areas to request assistance if required;
- Adequate lighting is provided to illuminate the work; and
- For Contractor work, regular “night shift” work shall require prior project approval.

Night security Workers shall:

- Not work alone, unless they have an adequate communication plan in place to contact other workers or emergency assistance as needed; and
- Maintain communications and check in at least every two hours with a control room or other workers familiar with the Worksite and the Emergency Response Plan for that project and/or operating Facility.

3.10 SANITARY FACILITIES

Contractor shall:

- Ensure adequate sanitary facilities at or near the worksite for the size and type of workforce to be employed;
- Provide workers with sufficient drinking fluids and provide access to toilets and hand washing facilities in accordance with applicable legislation; and
- Ensure that the Ground Disturbance Specification is referenced prior to securing a portable facility into the ground.
- Ensure that all facilities are adequately serviced and properly stocked; and ensure facilities are adequately secured against unintentional movement

Workers shall:

- Use the facilities provided;

4.0 APPENDIX

4.1 TABLE 1-HEAT INDEX FROM TEMPERATURE AND RELATIVE HUMIDITY READINGS

Relative Humidity	Actual Temperature ° F (° C)								
	• 70 (21.1)	• 75 (23.9)	• 80 (26.7)	• 85 (29.4)	• 90 (32.2)	• 95 (35.0)	• 100 (37.8)	• 105 (40.6)	•
0%	70 (21.1)	75 (23.9)	80 (26.7)	85 (29.4)	90 (32.2)	95 (35.0)	100 (37.8)	105 (40.6)	
10%	70 (21.1)	75 (23.9)	80 (26.7)	85 (29.4)	90 (32.2)	95 (35.0)	100 (37.8)	105 (40.6)	
20%	70 (21.1)	75 (23.9)	80 (26.7)	85 (29.4)	90 (32.2)	96.8 (36.0)	102.2 (39.0)	109.4 (43.0)	
30%	70 (21.1)	75 (23.9)	80.6 (27.0)	87.8 (31.0)	95 (35.0)	102.2 (39.0)	109.4 (43.0)	118.4 (48.0)	
40%	70 (21.1)	77.0 (25.0)	84.2 (29.0)	91.4 (33.0)	98.6 (37.0)	107.6 (42.0)	116.6 (47.0)	125.6 (52.0)	
50%	71.6 (22.0)	80.6 (27.0)	87.8 (31.0)	95 (35.0)	104 (40.0)	113 (45.0)	122 (50.0)		
60%	75.2 (24.0)	82.4 (28.0)	91.4 (33.0)	98.6 (37.0)	109.4 (43.0)	118.4 (48.0)	129.2 (54.0)		
70%	77.0 (25.0)	86 (30.0)	95 (35.0)	104 (40.0)	113 (45.0)	123.8 (51.0)			
80%	80.6 (27.0)	87.8 (31.0)	98.6 (37.0)	107.6 (42.0)	118.4 (48.0)				
90%	82.4 (28.0)	91.4 (33.0)	100.4 (38.0)	111.2 (44.0)	122 (50.0)				
100%	84.2 (29.0)	95 (35.0)	104 (40.0)	114.8 (46.0)	127.4 (53.0)				

* This table is based on: working conditions with little or no radiant heat; workers wearing regular summer clothing; un-acclimatized workers doing moderate work or acclimatized workers doing heavy work.

4.2 TABLE 2 -CORRECTION FACTOR (IN °F) FOR RADIATION HEAT, CLOTHING, AND WORKLOAD

Clothing	100% cloud cover		60% cloud cover		30% cloud cover		0% cloud cover		Work Type
	°F	°C	°F	°C	°F	°C	°F	°C	
FR + Vest	1	0.5	2	1	4	2	4	2	Light work
	2	1	3	1.5	4	2	5	2.5	Moderate work
	4	2	4	2	7	3.5	8	4	Heavy work
Clothing	100% cloud cover		60% cloud cover		30% cloud cover		0% cloud cover		Work Type
	°F	°C	°F	°C	°F	°C	°F	°C	
FR + Regular Tyvek ¹ + Vest	4	2	6	3	8	4	9	4.5	Light work
	6	3	8	4	9	4.5	11	5.5	Moderate work
	9	4.5	10	5	12	6	15	7.5	Heavy work

**The numbers in Table 2 indicate an increase in the heat index as a correction factor to reflect cloud coverage, clothing and type of work. For example; performing heavy work with FR clothing + vest with 100% cloud coverage would add 4°F to the heat index to obtain the final heat index. The work rest schedule would have to be determined based on the final heat index.

¹ Regular Tyvek suit is made of polypropylene. This is considered a breathable fabric. (Chemical resistant suits are coated with polyethylene. This type of garment is impermeable with no breathability.)

Examples of work types:

Rest - Sitting

Light work - Sitting with light manual work with hands or hands and arms and driving. Standing with occasional walking

Moderate work – Normal walking, sustained moderate hand and arm work, moderate arm and leg work, moderate arm and trunk work, light pushing and pulling

Heavy work – intense arm and trunk working carrying, shoveling, and manual sawing, pushing and pulling heavy loads

Very Heavy – Very intense activity at fast to maximum pace, e.g., shoveling wet sand

4.3 TABLE 3-TLVs WORK/WARM-UP SCHEDULE FOR OUTSIDE WORKERS BASED ON A 4-HOUR SHIFT

Air Temperature – Sunny Sky		No Noticeable Wind		5 mph (8 km/h) Wind		10 mph (16 km/h) Wind		15 mph (24 km/h) Wind		20 mph (32 km/h) Wind	
°C (approx.)	°F (approx.)	Max. Work Period	No. of Breaks**	Max. Work Period	No. of Breaks	Max. Work Period	No. of Breaks	Max. Work Period	No. of Breaks	Max. Work Period	No. of Breaks
-26° to -28°	-15° to -19°	(Norm breaks) 1		(Norm breaks) 1		75 min.	2	55 min.	3	40 min.	4
-29° to -31°	-20° to -24°	(Norm breaks) 1		75 min.	2	55 min.	3	40 min.	4	30 min.	5
-32° to -34°	-25° to -29°	75 min.	2	55 min.	3	40 min.	4	30 min.	5	Non-emergency work should cease	
-35° to -37°	-30° to -34°	55 min.	3	40 min.	4	30 min.	5	Non-emergency work should cease			
-38° to -39°	-35° to -39°	40 min.	4	30 min.	5	Non-emergency work should cease		Non-emergency work should cease			
-40° to -42°	-40° to -44°	30 min.	5	Non-emergency work should cease		Non-emergency work should cease		Non-emergency work should cease			
-43° & below	-45° & below	Non-emergency work should cease		Non-emergency work should cease		Non-emergency work should cease		Non-emergency work should cease		Non-emergency work should cease	

*2013 TLVs and BEIs – Threshold Limit Values for Chemical Substances and Physical Agents and Biological Exposure Indices. Cincinnati: American Conference of Governmental Industrial Hygienists (ACGIH), 2013-page 202

<END OF DOCUMENT>



Contractor Safety Specification

Fall Protection

Table of Contents

1.0	Definitions & Acronyms.....	2
2.0	Contractor Responsibilities	2
3.0	Specification Requirements	3
3.1	Fall Protection Requirement.....	3
3.2	Fall Protection Plan	3
3.3	Fall Protection Equipment Requirement.....	4
3.3.1	Anchor Points	5
3.3.2	Vertical and Horizontal Lifelines	5
3.4	Fall Protection Systems	6
3.4.1	Guardrails.....	6
3.4.2	Travel Restraint.....	6
3.4.3	Personal Fall Arrest System.....	7
3.4.4	Safety Nets.....	7
4.0	References.....	8
5.0	Appendix.....	9
	Rescue Considerations	9

1.0 DEFINITIONS & ACRONYMS

Applicable legislation—All federal, provincial, state and municipal laws, regulations, codes, bylaws, ordinances or otherwise that are applicable to the jurisdiction in which the work is conducted including, but not limited to the Canada Labor Code, OSHA, State OSHA, Provincial and Territorial OH&S.

Construction work—means work for construction, alteration, and/or repair, including painting and decorating (OSHA DEF).

Enbridge—Enbridge, Inc. and Enbridge (U.S.) Inc., hereinafter will be referred to as “Company”.

General industry—refers to all industries not included in agriculture, construction or maritime (OSHA DEF).

Maximum arresting force—is the largest amount of force that the fall protection system and the person attached to the system will experience as generated by the deceleration device.

Manbasket—is a personnel platform which is raised, lowered or held in working position by the hoisting line of a crane or hoist, or is attached to a crane boom.

Qualified worker—A Worker who, by possession of a recognized degree, certificate, or professional standing, or who by knowledge, training and experience, has successfully demonstrated their ability to solve or resolve problems relating to the subject matter, the work, or the project (OSHA DEF).

Self-Retracting Devices (SRD)—a deceleration device containing a drum-wound line that can be slowly extracted from, or retracted onto, the drum under slight tension during normal worker movement, and which, after onset of a fall, automatically locks the drum and arrests the fall. Once activated, it will stop the action of a fall. (OSHA DEF).

Swing stage and work cages—a suspension scaffold consisting of a platform supported by hangers (stirrups) suspended by two ropes from overhead supports and equipped with means to permit the raising and lowering of the platform to desired work levels. (OSHA DEF).

2.0 CONTRACTOR RESPONSIBILITIES

Contractor shall:

- Ensure that workers and subcontractors under their control are aware of and comply with this specification;
- Ensure that all required fall protection equipment resources are readily available;
- Ensure that only qualified workers are designated to develop fall protection plans and to certify horizontal lifelines; and
- Ensure all workers required to work at heights receive fall protection training.
- Inspect and use fall protection equipment as per manufacturer’s specifications;

Uncontrolled Copy if Printed or Downloaded

- Inspect fall protection equipment prior to use;
- Remove damaged and/or impact loaded equipment from service;
- Implement fall protection and rescue plans as required;
- Ensure Fall protection training has been completed and is current;
- Complete fall protection plan as required by the specification;
- Be appropriately trained and qualified by the manufacturer to certify the horizontal lifeline; and
- Be appropriately trained and qualified to develop a fall protection plan.

3.0 SPECIFICATION REQUIREMENTS

3.1 FALL PROTECTION REQUIREMENT

Guardrail systems, safety net systems, personal fall arrest, or travel restraint systems shall be used when Company and/or contractor workers are performing any duties on an unprotected, elevated work surface with a Fall Hazard, which the Company defines as:

- 1.2m (4ft.) or more above a lower level from a Permanent walking/working surface (horizontal and vertical surface) or
- 1.8m (6ft.) or more above a lower level from a Temporary walking/working surface (includes construction activities) or
- Any fall where there is an unusual possibility of injury (e.g., falling through an opening in a work surface)

3.2 FALL PROTECTION PLAN

A written fall protection plan shall be completed by a qualified worker whenever workers could potentially fall 1.83m (6ft.) or more where they are not protected by a guardrail system. The plan shall contain the following:

- Fall hazards at the worksite,
- Fall protection system(s) to be used,
- Anchors to be used,
- Clearance distances below the work area are sufficient to prevent a worker from striking the ground or an object or level below the work area,
- Procedures used to assemble, maintain, inspect, use and disassemble the fall protection system, and
- Rescue procedures to be used if a worker falls from a height and is suspended in the air (not required if travel restraint system is being used).

Note: see Appendix for rescue considerations

3.3 FALL PROTECTION EQUIPMENT REQUIREMENT

Fall protection equipment shall meet the requirements of the CSA/ ANSI in Canada and ANSI standards in the US and be maintained and used in accordance with the manufacturing specifications. All components of a fall protection system shall be compatible with one another and with the environment in which they are being used.

Workers shall never be permitted to work alone in a harness when there is a fall potential of 1.83m (6ft.) or more.

All Fall Protection equipment shall be

- Used only for fall protection purposes,
- Kept free of substances and conditions that would contribute to deterioration,
- Destroyed if it is defective,
- Destroyed if it contacts heat, chemicals or other substances that could cause damage,
- Removed from service and destroyed if subjected to impact loading and/ or
- Recertified and inspected as specified by the manufacturer and applicable legislation.

Lanyards, self-retracting devices (SRD) and lifelines shall

- Use softeners when attaching lines to structures (and elsewhere as necessary) and/or where contact with sharp edges are possible,
- Be protected from damage such as abrasion and chafing,
- Be kept free of knots,
- Be used for fall arrest or travel restraint when anchored appropriately, and
- Be compatible with the fall protection equipment being used.

Fall Protection connecting hardware- such as carabiners, connectors and snap hooks shall

- Be self-closing and self-locking,
- Require two deliberate consecutive actions to open, and
- Be marked with the manufacturer's name and the breaking strength.

Note: Sling anchors that do not have connectors can be used with an approved carabiner.

Harnesses used for fall protection shall:

- Only be full body harnesses rated for the worker's weight as per manufacturers' guideline,

- Be selected for specific applications and consider:
 - Compliance,
 - Potential arrest injury,
 - Suspension trauma, and
- Have buckles that hold securely without slippage or other failure.

3.3.1 ANCHOR POINTS

Anchor points shall be capable of withstanding the impact forces applied to them and have a minimum breaking strength of 5000lb. 22.2kN; where this cannot be met, use two times the maximum arresting force.

Anchor points come in a wide variety of forms and are usually built to meet the needs of the specific fall protection equipment being used by the worker. This equipment can be connected to a variety of anchorages that are capable of supporting a fall arrest system such as:

- A secured I-beam,
- A concrete column,
- An engineered floor structure, or
- Another device approved by a professional engineer licensed in the applicable province/state.

3.3.2 VERTICAL AND HORIZONTAL LIFELINES

3.3.2.1 Horizontal Lifelines

Horizontal lifelines may be flexible or rigid and shall comply with the following:

- Be designed, installed, and used under the supervision of a qualified worker, as part of a complete fall arrest system, which maintains at least two times the Maximum Arresting Force, or travel restraint system,
- Horizontal lifeline systems shall be certified by a professional engineer licensed in the applicable province/ state, the manufacturer, or a qualified worker authorized by either the professional engineer or the manufacturer, and
- Have each worker attached to a separate lifeline unless manufacturer or engineer recommendations allow otherwise.

Approved lifelines may be used for horizontal travel restraint or fall protection.

3.3.2.2 Vertical Lifelines

Vertical lifelines shall:

- Be provided for each worker on Swing stages and work cages,
- Be securely anchored to an independent approved structure of adequate strength so that failure of the equipment will not cause failure of the lifeline,
- Meet the strength requirements of applicable legislation, and
- Be long enough to reach the ground.

3.4 FALL PROTECTION SYSTEMS

The following flow chart depicts the hierarchy of fall protection that shall be followed whenever working at heights.

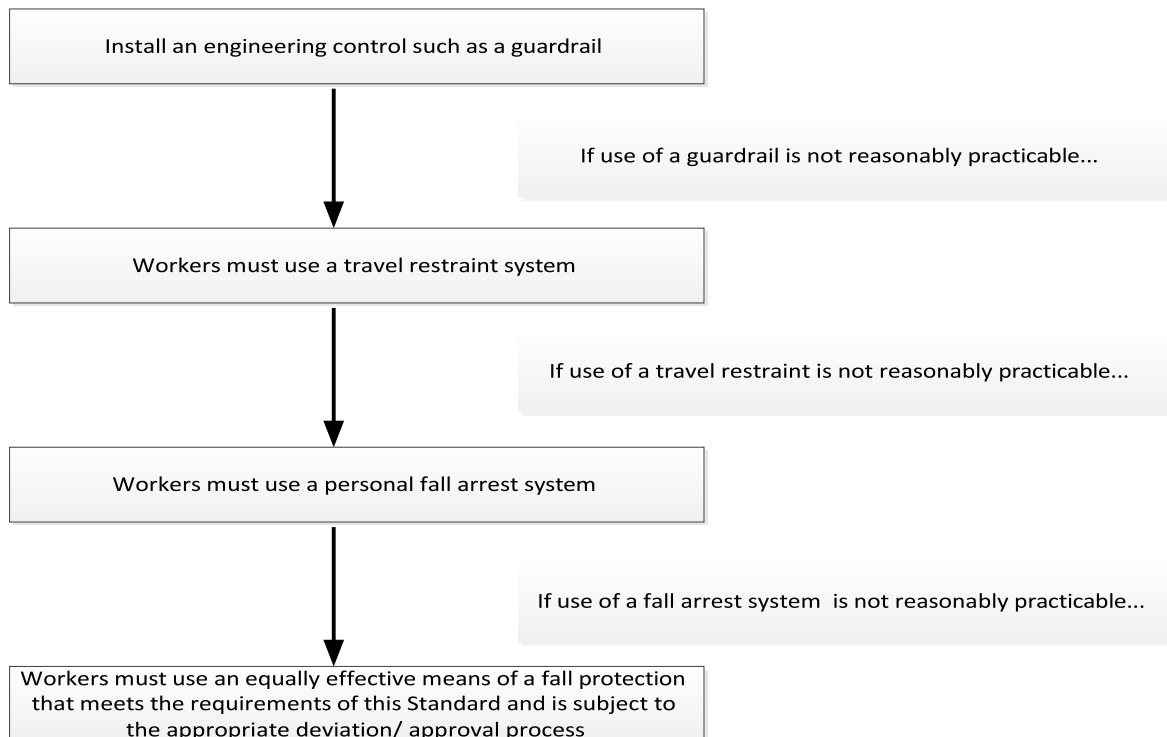

3.4.1 GUARDRAILS

Guardrails installed must meet legislative requirements

3.4.2 TRAVEL RESTRAINT

Travel restraint systems shall:

- Be utilized as a means of preventing workers from reaching the edge or work location in which they could fall,
- Use approved travel restraint anchor points or certified horizontal life lines,

- Prevent access to the edge at all points when device or rope is fully extended, and
- Be used when working in a manbasket.

3.4.3 PERSONAL FALL ARREST SYSTEM

All workers shall wear a personal fall arrest system when:

- It is impractical to provide adequate work platforms, scaffolds, staging and guardrails, and/or
- Working on swing stages and in work cages.

Personal fall arrest systems when stopping a fall shall

- Limit the maximum arresting force to 1,800lbs. (8kN) when using a full body harness as per applicable legislation, which will vary depending on the type of harness and lanyard,
- Not allow a worker to free fall more than 1.83m (6ft.) or to contact a lower level with shock absorbing lanyard,
- Not allow a worker to free fall more than 1.2m (4ft.) or to contact a lower level without a shock absorbing lanyard,
- Limit maximum deceleration distance to 1.07m (3.5ft.), and
- Not allow worker to swing and hit objects.

Lanyards used for fall arrest shall:

- Be secured to an approved lifeline or fixed anchorage point,
- Be secured whenever possible above the waist or overhead to minimize actual fall distance,
 - If not reasonably practicable to attach to an anchor above the level of a workers waist, the worker must ensure that the clearance and the maximum arresting force requirements are met, and
- Allow for 100 % tie off.

Where practical, the use of a retractable lanyard in place of a basic lanyard system is recommended.

3.4.4 SAFETY NETS

Where safety net protection is required based on a hazard assessment and applicable legislative requirements, work shall not commence until the net is in place and has been tested in accordance with applicable requirements. Prior to using safety nets contact the safety department for review and assistance.

A professional engineer licensed in the applicable province/ state must certify any structure to which a personnel safety net is attached. The certification must indicate that the structure is capable of withstanding any load the net is likely to impose on it depending on the circumstances of the work site.

Safety nets shall:

- Be installed and maintained so that the maximum deflection under impact load does not allow any part of the net to touch another surface,
- Have safety hooks or shackles of drawn, rolled or forged steel with an ultimate tensile strength of not less than 5000lbs (22.2kN),
- Have joints between net panels capable of developing the full strength of the web,
- Extend not less than 2.4m (7ft.) beyond the work area, and
- Extend not more than 6m (18ft.) below the work area.

4.0 REFERENCES

ANSI_Z359_1_2016_WM – Fall Protection Code

CAN/CSA-Z259.10-12 (R2016) - Full body harnesses

Canada Labour Code, Part II:

- Canadian Occupational Safety & Health (COSH) regulations, Fall Protection Systems 12.10

Occupational Safety and Health Administration (OSHA)

- Personal Fall Protection Systems, 29 CFR 1910.140
- Duty To Have Fall Protection , 29 CFR 1910
- Fall protection systems & falling object protection-criteria and practices, 29 CFR 1910.29

5.0 APPENDIX

RESCUE CONSIDERATIONS

When a worker is suspended from a height while using a fall arrest system, it can result in serious physical injury, or potentially death in less than 30 minutes.

To reduce the risks associated with short or long periods of suspension, the following should be considered when determining rescue procedures as part of the fall protection plan:

- List of required resources should a fall occur (workers and associated qualifications related to rescue, specific equipment, external parties),
- Specific factors that may hinder a rescue (location, access to suspended worker etc.) and how those factors will be mitigated,
- Rescue any suspended workers as quickly as possible, orthostatic intolerance can occur within 3 minutes of suspension,
- Be aware that a suspended worker is at risk of orthostatic intolerance and suspension trauma,
- Be aware of signs and symptoms of orthostatic intolerance (light-headedness, dizziness, fatigue, blurred vision),
- Be aware that a suspended worker who is unconscious or has a head injury is particularly at risk of orthostatic intolerance,
- Be aware of factors that can increase the risk of suspension trauma,
- If practical, have a medical professional present when moving a Worker to a horizontal position following suspension,
- Use of rescue stirrups to allow suspended workers to maintain Blood flow, and
- Rope/cable tenders shall make certain the harness user is conscious at all times.



Contractor Safety Specification

Fatigue Management

Table of Contents

1.0	Definitions & Acronyms.....	2
2.0	Contractor Responsibilities	2
3.0	Specification Requirements	3
3.1	Contractor Site leader Expectations.....	3
3.2	Fatigue Mitigation Plan.....	3
4.0	Training Requirements.....	4
5.0	References.....	4
6.0	Appendix.....	5
6.1	Fatigue Management Best Practices	5
6.1.1	Fatigue Prevention Best Practices	6
6.1.2	Fatigue Mitigation Countermeasures.....	6
6.1.3	Fatigue Considerations for Drivers	7
6.1.4	Fatigue Considerations for Incident Investigations	8
6.1.5	Body Clocks (Circadian Rhythm)	8
6.1.6	The Importance of Sleep	10
6.1.7	Nutrition.....	11
6.1.8	Active Living	12

1.0 DEFINITIONS & ACRONYMS

Enbridge- Enbridge, Inc. and Enbridge (US) Inc., hereinafter will be referred to as “Company”.

Fatigue - A state of reduced mental and physical alertness or functioning caused by sleep-related disruption or deprivation. Fatigue is a feeling of tiredness or exhaustion that comes from physical or mental exertion. It is a message to the body to rest. Fatigue can be aggravated by acute lack of sleep or an accumulated sleep debt.

Fatigue Mitigation Plan – A plan for addressing fatigue at the worksite or the office.

Fitness for duty - Fitness for duty means that an individual is in a physical, mental, and emotional state which enables the worker to perform the essential tasks of his or her work assignment in a manner which does not threaten the safety or health of his or herself, co-workers, property, or the public at large.

Micro sleeps - A state of up to 60 seconds where the brain goes to sleep and the worker blacks out no matter what they are doing.

Optimum Scheduling - Schedules that align to normal human sleep patterns and social compatibility, in addition to operational efficiency and effectiveness.

Simple or Monotonous Tasks - Routine tasks lasting half an hour or more.

Sleep Debt - The state of chronic fatigue and sleepiness that results from the lack of sufficient sleep or disrupted sleep.

2.0 CONTRACTOR RESPONSIBILITIES

Contractors shall:

- Ensure that workers are aware of and comply with this Specification;
- Ensure that work schedules comply with all applicable standards and procedures;
- Monitor personnel for the signs and symptoms of fatigue;
- Complete or ensure the completion individual fatigue assessments and fatigue mitigation plans;
- Approve controls for managing fatigue where required;
- When performing incident investigations, confirm if fatigue was a contributing factor to the event and assign mitigation as appropriate, including potential improvement opportunities within this Specification.
- Be fit for duty at the commencement of and during the work shift;
- Communicate personnel fatigue concerns to their site leader;
- Monitor for signs and symptoms of fatigue within their co-workers;
- Support and participate in risk mitigation activities; as required; and

Uncontrolled Copy if Printed or Downloaded

- Stop work when the activities are unsafe due to fatigue.

3.0 SPECIFICATION REQUIREMENTS

3.1 CONTRACTOR SITE LEADER EXPECTATIONS

Site leaders are accountable for the safe and reliable execution of work on a project. This includes recognizing and mitigating the risk of fatigue within their workforce.

Site leaders will often need to rely on their subjective judgement to assess if a worker(s) is suffering from impairment due to fatigue. This includes performing informal 'fit for duty' assessments during interactions with their reports. If an worker is displaying symptoms of fatigue such as:

- red eyes
- subdued responsiveness
- excessive yawning
- micro sleeps | head bobbing
- quiet and withdrawn
- eye rubbing

The site leader should have a private conversation with the individual and ask open ended questions in order to understand if fatigue is a concern and if further action is required.

3.2 FATIGUE MITIGATION PLAN

A fatigue mitigation plan is a written document that highlights the fatigue related risk associated with the upcoming work, details of the impact the risk potentially could have at the worksite, describes what controls will be implemented to effectively manage the risk and who is responsible for implementation. A fatigue mitigation plan is required when:

- A worker self-reports that he or she is not fit for duty, or
- When a site leader deems that a worker is not fit for duty, or
- Extended work day including travel time to and from the worksite that exceeds 14 consecutive hours, or
- Evenings where a worker who is on-call has received more than one call-out that evening or will be awake for 17 consecutive hours or greater.

There are a number of different options on how a fatigue mitigation plan can be developed and executed. These include the following:

- 1) Utilizing the Field Level Hazard Assessment (FLHA) process, or

- 2) A specific fatigue mitigation plan developed for workers who are on an on-call rotation that provides pre-determined proactive direction on how workers can manage fatigue risk during extended callout scenarios, or
- 3) Verbal agreement between a site leader and worker that is documented (i.e. personal day timer, FLHA, etc.), or
- 4) Fatigue mitigations detailed within a Project Safety Plan or Safe Work Permit.

4.0 TRAINING REQUIREMENTS

Personnel working in the field must be knowledgeable in this Specification.

5.0 REFERENCES

Occupational Safety and Health Administration (OSHA) Act

- Section 5, Duties

Canada Labour Code, Part II:

- Canadian Occupational Health & Safety Regulations, Hazard Prevention Program; Part XIX

6.0 APPENDIX

6.1 FATIGUE MANAGEMENT BEST PRACTICES

Fatigue Impacts and Consequences

Fatigue has a significant influence on health and safety both at work and at home. Fatigue causes slower reaction times and can result in poor decisions, more mistakes, decreased performance, and dangerous memory lapses. When examining work and fatigue, research demonstrates that the probability of a workplace incident rises with a decrease in alertness. Findings from research confirm that:

- The highest rate of industrial incidents is usually found among shift workers and are most likely to occur at times when workers are most prone to sleep.
- On the roads, more vehicle collisions occur in the early morning hours than at other times. Drivers in fatigue-related incidents had an average of five and a half hours during their last sleep period and evidence shows that the one hour lost in the switch to daylight savings time increases collision rates by seven percent (NTSB, 1995).
- Findings suggest that after only 20 hours of sustained wakefulness, a person may be as impaired as someone with a blood alcohol concentration of 0.10 percent. (Lamond&Dawson, 1999)

There are many variables that can impact the level of fatigue within an individual or a work team. Examples include:

Variables Impacting Fatigue		
Time of Day	Availability of food and water	Working Alone
Temperature	Lifestyle Choices	Corporate Culture
Repetitive Functions	Type of Work	PPE
Stress	Length Frequency of Breaks	Shift Duration

Consequences of fatigue result in reduced response time and overall cognitive impairment of a worker. Other examples include:

Consequences of Fatigue		
Decreased Alertness	Inadequate Performance	Slow Reaction Time
Reduced Motivation	High Rate of Error	Impaired Judgement
Failure to Respond	Poor Decision Making	Ineffective Communication
Reduced Short-Term Memory	Micro-Sleeps	Increased Risk Tolerance

Uncontrolled Copy if Printed or Downloaded

6.1.1 FATIGUE PREVENTION BEST PRACTICES

Site leaders and workers must have a strong understanding of the science behind fatigue in order to effectively management it. This understanding and awareness will support worksite recognition and the implementation of effective mitigations that will minimize the negative impacts to workers and the organization. For more information on managing sleep cycles, sleep disorders, proper nutrition and active living refer to the Appendix of this specification.

6.1.2 FATIGUE MITIGATION COUNTERMEASURES

Site leaders and workers can implement many different types of countermeasures to successfully mitigate fatigue in the workplace. These opportunities can be segregated into individual and team based controls. For addressing individual fatigue, potential mitigation alternatives include:

Fatigue recognition awareness within crew Tool Box Talks	Increase social interaction	Transport home
Ensure adequate hydration and food intake	Complete higher risk tasks earlier in the shift	Use the buddy system
Take short and frequent breaks	High intensity task rotation within crew	Temperature control
Power nap or quiet time	Increased physical activity when required	Lower risk task assignment
Length and timing of shifts	Identify health problems which may affect a workers's ability to work extended hours	Adequate lighting for work space

The above examples are also suitable for managing fatigue risk within a work team or crew. Other examples that can also be used by a site leader to mitigate fatigue risk for their team include:

Inform and educate all workers about the Fatigue Management Specification including contractors personnel	Solicit additional resources to help minimize extended hours	Communicate team fatigue status and mitigation control effectiveness during toolbox talk
Minimize extended hours of work when possible	Defer non-urgent work	Give as much advanced notice of extended hours and a minimum of 24 hours' notice if shift changes
Recognize individual and crew fatigue, and encourage workers to look out for each other (increase cross-checking)	Increase supervision	Designated driver for crew
Shift fatigue assessments	Group physical activity (for sedentary work)	Increase safety observations

6.1.3 FATIGUE CONSIDERATIONS FOR DRIVERS

Any factor that affects a driver’s ability to safely operate a motor vehicle is impairment. These factors include physical (fatigue), psychological (personal problems/aggressiveness), or chemical (alcohol or drugs) resulting in delayed response time, weakening physical coordination, and reduced attention span.

There are several indicators that an worker or site leader can recognize that indicates that a driver may be or becoming fatigued and mitigation action is required:

Trouble keeping eyes open/head up	Missing a gear or braking too late	Frequent yawning, nodding off
Failure to check mirrors	Difficulty maintaining a constant speed	Failure to dim high-beams at night
Disconnected or wandering thoughts	Drifting in and out of sleep	Difficulty in remembering the last few kilometers
Hallucinations/daydreaming	Missing an exit or road sign	Red eyes and constant blinking
Driving long distances without rest breaks	Driving through the night or the early afternoon	Working shifts or extended hours

Best practices to manage fatigue for workers who drive on a regular basis include:

Pay attention to your body clock: Regardless of hours worked or sleep attained, during the hours of 2 a.m. to 5 a.m. and again from 2 p.m. to 4 p.m., biological clocks are programmed towards sleep. Plan driving itineraries by factoring in circadian (body clock) “low points” potentially avoiding driving at these times of day.

Get the amount of sleep you need to be effective at work the next day: The average person needs 7 to 8 hours of sleep to feel fully refreshed.

Journey management: Plan trips carefully, including where and when to stop for food, sleep and rest and active movement breaks. Planning and having enough time are the keys to safe driving.

Recognize drowsiness: Realize the signs of sleepiness and mitigate immediately. Pull over to a safe place to rest or power nap. Do not drive for more than four hours straight. Two hour driving stretches are recommended. Napping is one of the most effective countermeasures to sleep deprivation. Naps should be between 20 and 30 minutes in duration.

Follow driving best practices: Perform a few physical exercises when the vehicle is stopped. Keep temperatures within vehicle at a comfortable level remembering that heat contributes to drowsiness. Drink water as often as possible—six to eight glasses a day. Stay mentally alert: listen to music, mentally calculate distances. Start your work shift with zero sleep debt.

6.1.4 FATIGUE CONSIDERATIONS FOR INCIDENT INVESTIGATIONS

Fatigue can be a significant contributing factor to incidents or near misses within the workplace. Investigation leads should be cognizant of this potential and ensure that their investigations review the following elements:

- When did the worker last sleep?
- How long did the worker sleep the last time?
- Did the worker have a restful sleep?
- What was the time of shift?
- How many consecutive hours had the worker worked?
- What and when was the worker's last break between shifts?
- How many days did the worker work in a row?
- How many hours did the worker work on those days?
- Are there any other human factors that may have affected the worker's fatigue level?

Answering these questions will provide the investigation team the knowledge required to determine if fatigue was a contributing factor within the event. Corrective actions can then be implemented to ensure the incident does not reoccur.

6.1.5 BODY CLOCKS (CIRCADIAN RHYTHM)

All workers possess a biological clock that works on an approximately twenty-four hour cycle. It is called the circadian rhythm, meaning daily rhythm. This body clock is situated in the brain and controls sleep cycle, affects hormonal levels, digestion, body temperature, and ability to think. During the day, as the body temperature rises, waking up occurs, levels of cortisol (a hormone which helps maintain wakefulness)

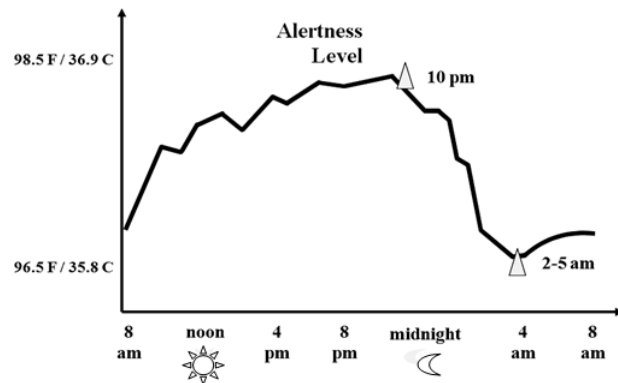

increases while production of growth hormone (for restoring tissue) goes down. The greatest influence on fatigue within the body is the rise and fall of actual body temperature during the course of a day. When the temperature goes down this creates a powerful physiological desire to sleep. Body temperature begins to rise just before wake-up time. Throughout the day temperature rises till about 2:00 p.m. and as a result workers function at peak efficiency. They are most alert, digestion is working, and physical strength is at a high. Between 2:00 and 4:00 p.m. core body

temperature takes a sharp drop. This “post-lunch dip” is accompanied by a drop in alertness, and increased fatigue. Following this drop, the body temperature rises again, reaching peak efficiency in the late afternoon and early evening. Later as the core temperature begins to drop, the body begins to slow down around 9:00 p.m. There is a critical time between 2:00 and 5:00 a.m. when our circadian rhythms program us to sleep. A number of fatigue related collisions increase significantly at 2:00 p.m. and 2:00 a.m. Natural body rhythms make workers less attentive in the middle of the afternoon and after 9:00 p.m. These times of decreased alertness can limit on-the-job performance and increase the risk of an accident.

There are several best practices that a worker can follow to minimize this risk by:

- ✓ Start the morning with a good breakfast. Have a snack 2 or 3 hours later that morning to stabilize blood sugar level.
- ✓ Keep lunches to a reasonable size. A large meal increases the urge to sleep.
- ✓ Make sure your breakfast and lunch contain protein, carbohydrates and good fats. Avoid high fat lunches. Limit food that has high amounts of saturated or hydrogenated fats.
- ✓ Avoid foods high in sugar since sugar can lead to blood sugar spikes that result in a powerful insulin response.
- ✓ Hydration. Have a glass or two of cold water
- ✓ Make it a habit that during the 2:00 p.m. to 4:00 p.m. time tasks requiring precise concentration are routinely done at other times.
- ✓ Go for a brisk walk, get fresh air, get natural light at this time, or have a brief stretching routine.
- ✓ Where appropriate, take a 15 to 20 minute power naps. A power nap can return two hours of high productivity.
- ✓ Incorporate aerobic exercise within your work routine during times of drowsiness or tiredness

6.1.6 THE IMPORTANCE OF SLEEP

Sleep is an important life function as the average person needs about 7 - 8 hours of sleep a day. There are two kinds of sleep: REM sleep (dreaming sleep) and non-REM (orthodox sleep). REM stands for rapid eye movement because our eyes move rapidly during that stage. Non-REM sleep comes in two variations: the light type of sleep called Stages 1 and 2, and the much deeper version called delta sleep (or Stages 3 and 4). Going to sleep is like going down an escalator. Stage 1 is followed by Stage 2, then into deep sleep in Stages 3 and 4. The sleep cycle is completed with a period of REM (dreaming sleep). A full cycle of sleep takes about 90 minutes and there are about 5 or 6 sleep cycles per night. If these stages are interrupted then a worker is at a higher risk for fatigue at the worksite for their upcoming shift.

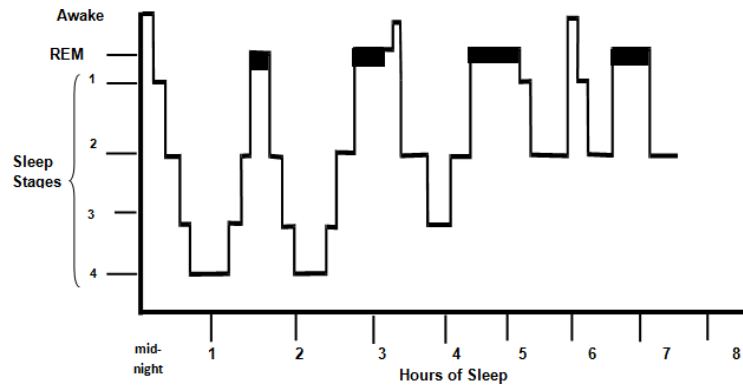

Best practices that a worker can utilize to ensure a good night sleep are:

- ✓ Get an adequate amount of sleep every night. Identify the amount of sleep required to be fully alert all day long, and get that amount every night.
- ✓ Get uninterrupted sleep. For sleep to be rejuvenating, it should be attained within one continuous block.
- ✓ Stick to the same schedule. Try to wake up and go to bed at the same time each day.
- ✓ After finishing a hard day at work it is really important to wind down. Build in time during the evening to relax and recover. If there are things on your mind, set aside time before or after supper to worry about them. Don't discuss or think about stressful things just before you go to sleep.
- ✓ Develop a regular bedtime routine. Develop routines to practice before you go to sleep. Have a shower or hot bath and bring light reading material such as a favorite magazine.
- ✓ Make up for lost sleep as soon as possible. To catch up, go to bed earlier.
- ✓ Keep your bedroom dark and quiet. Sleep on a good bed.
- ✓ A somewhat cool 19 to 20 degrees Celsius (66-68 F) room also contributes to a better sleep.
- ✓ Aerobic exercise increases deep sleep, but don't do it close to bedtime.
- ✓ Reduce caffeine intake for six hours before going to bed.

Uncontrolled Copy if Printed or Downloaded

- ✓ Avoid alcohol near bedtime. Both NREM (deep, restorative) and REM (active dreaming) sleep will be suppressed, and early-morning awakening will be experienced if alcohol is consumed within two hours of bedtime.

One factor workers often overlook when they sleep poorly is the possibility of a sleep disorder. These range from insomnia to sleep apnea, restless leg syndrome, advanced and delayed sleep phase.

Insomnia is a persistent disorder that can make it hard to fall asleep, hard to stay asleep or both, despite the opportunity for adequate sleep. Insomnia is a symptom of an overactive arousal system (having trouble going to sleep) or an underactive sleep system (sleep system isn't working properly to put and keep you asleep).

Sleep apnea is a serious, potentially life-threatening sleep disorder in which breathing is briefly and repeatedly interrupted during sleep. The "apnea" in sleep apnea refers to a breathing pause that lasts at least ten seconds. Obstructive sleep apnea occurs when the muscles in the back of the throat fail to keep the airway open, despite efforts to breathe.

Restless Legs Syndrome is characterized by tingling, crawling, or restless sensations in the legs, which prevents falling asleep.

Delayed/Advanced Sleep Syndrome is a condition resulting from a mismatch between the body clock and scheduled time. People with delayed sleep phase feel sleepy later at night, and those with advanced sleep phase feel sleepy early in the evening.

If you believe you may have any of these sleep disorders it is highly recommended to get treatment from a professional. Most sleep disorders can be effectively treated.

6.1.7 NUTRITION

A "well-balanced diet" contains food from all four food groups including vegetables, fruit, grain products, milk products and meat. Each food group provides a unique set of nutrients. Meals containing all four food groups are more likely to obtain the majority of nutrients required for a healthy adult to minimize the risk of fatigue onset. Three principles to remember during meal times are:

- 1) The majority of your plate should be covered with choices from the Fruits & Vegetables Group and the Grains Group.
- 2) Limit the size of your meat portions to 3 – 4 oz. (about the size of a deck of playing cards).
- 3) Choose carbohydrate and protein foods at each meal to keep appetite in check for 3 to 4 hours and keep the added fats to a minimum.

Because of the nature of worker schedules, eating at regular times and having properly prepared food may be challenging. Utilize the best practices below to assist with achieving proper nutrition and minimize the effects of fatigue at work and home:

- ✓ Choose easy to digest foods such as fish, lean meats, skinless chicken, rice, vegetables, soybeans, tofu, fruits, whole grain breads, and cereals, and low fat milk or cheese products.
- ✓ Cut down on heavy, saturated fat found in foods such as fatty meats, pastries, pizza, potato chips, rich dairy products, sausages, pork and fried foods.
- ✓ For extra energy eat more protein. Protein contains the amino acid, tyrosine, which converts to the alertness neurotransmitters norepinephrine and dopamine. Proteins include: lean meats, skinless chicken, fish, soybeans, and low fat milk or cheese products. Meat and alternatives should be 3 to 4 ounces for lunch and supper, for a total of 6 to 8 ounces per day (2 decks of cards).
- ✓ To induce sleep and calm nerves eat some carbohydrates prior to going to sleep. Carbohydrates assist the amino acid, tryptophan, which converts to the calming neurotransmitter serotonin. Carbohydrates include: corn flakes cereal, bread, mashed potatoes, waffles, fruit, granola, and macaroni and other pastas.
- ✓ Add fiber to your diet with plenty of vegetables, cereals, and whole grain breads
- ✓ Try to follow a regular three meal a day pattern. Have at least one hot meal a day. Improve your meals with snacks every two to three hours (Grazing versus gorging).
- ✓ Drink 6 to 8 glasses of water a day
- ✓ Avoid food and beverages containing caffeine (e.g. coffee, pop) within 4 hours of bedtime.

6.1.8 ACTIVE LIVING

Regular physical activity will improve sleep, increase alertness and minimize the effects of fatigue. Unfortunately, work schedules can make it difficult regular exercise. Ideally workers should strive for 30 minutes or greater of physical activity each week. Activity time can be accumulated throughout the day in five or ten minute intervals. In fact, ten

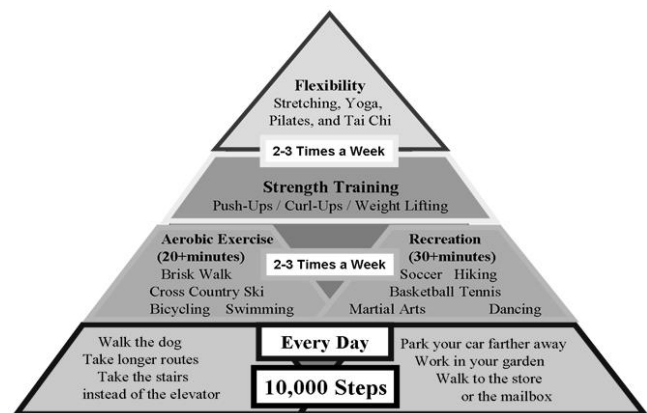

minutes of reasonable physical activity (walking) in three separate intervals produces the same health benefits as 30 minutes of continuous physical activity. So, having a brief 10 minute walk during two or three scheduled rest breaks does add up. Achieving the Fitness Pyramid details on

a weekly basis will provide significant health and fitness benefits as well as mitigate the fatigue impacts at home and the worksite.

Figure 4 Nadon Consulting 2010

<End of Document>



Contractor Safety Specification

Field Ergonomics

Table of Contents

1.0	Definitions & Acronyms.....	2
2.0	Contractor Responsibilities	2
3.0	Specification Requirements	2
3.1	Manual Lifting Requirements.....	3
4.0	References.....	4
5.0	Appendix.....	5

1.0 DEFINITIONS & ACRONYMS

Ergonomics - is the science of fitting the workplace to the worker, not the fitting worker to the workplace. Ergonomics is concerned with designing working systems in which human beings interact with machines and workplace tasks.

Musculoskeletal Injury (MSI) - an injury or disorder of the muscles, tendons, ligaments, joints, nerves, blood vessels or related soft tissue including a sprain, strain and inflammation, that may be caused or aggravated by work.

2.0 CONTRACTOR RESPONSIBILITIES

Contractors shall:

- Implement an effective Field Ergonomic Specification that meets or exceeds all applicable regulatory requirements and the requirements set out in this specification,
- Ensure workers are trained in the Field Ergonomic Specification as required and provide record of training when requested.

3.0 SPECIFICATION REQUIREMENTS

Field work that is most likely to pose ergonomic hazards to a worker includes:

- Manual handling;
- Heavy lifting;
- Twisting movements;
- Repetitive and static postures;
- Compression or contact stress; and
- Long hours of working in awkward positions.

Workers can address these hazards through the completion of a detailed field level hazard assessment that may utilize some of the preferred mitigative controls listed below:

- Using proper lifting techniques;
- Good housekeeping;
- Worker rotation, more task variety, and increased rest break if necessary;
- Personal protective equipment, such as knee pads, vibration gloves, and similar devices;
- Appropriate tool or equipment selection for that job; and
- Utilize appropriate lifting equipment where applicable.

When acquiring tools for regular use consider the following ergonomic features:

Uncontrolled Copy if Printed or Downloaded

Internal Information

- Tools should be light-weight and handles designed to allow a relaxed grip so the wrists can remain straight;
- Tools should be designed for use with either hand and be of various sizes so they are appropriate for all workers;
- Tool handles should be shaped so that they contact the largest possible surface of the inner hand and fingers. Avoid tool handles with sharp edges and corners;
- Use power tools to reduce the amount of human force and repetition required; and
- Purchase low-vibration tools to reduce tool vibration, and, if necessary, fit absorbent rubber sleeves over the tool handle.

3.1 MANUAL LIFTING REQUIREMENTS

Contractor field office workers whose primary tasks (i.e. administrative roles) do not include manual lifting must not manually lift or carry materials, goods or things in excess of 23 kg (50lbs).

Where a worker is required manually to lift or carry loads weighing in excess of 10 kg (22lbs), the worker shall utilize the following basic diagonal lifting technique:

1. Get as close to the object as possible.
2. Use a wide stance with one foot forward and to the side of the object for good balance.
3. Keep your back straight, push your buttocks out, and use your legs and hips to lower yourself down to the object.
4. Slide the object as close to you as possible.
5. Put the hand (same side of your body as the forward foot) on the side of the object furthest from you.
6. Use this basic lifting technique for small objects when you can straddle the load and use a wide stance.
7. Put the other hand on the side of the object closest to you. Your hands should be on opposite corners.
8. Grasp the object firmly with both hands.
9. Prepare for the lift, tighten your core muscles, look forward and upward, keep a straight and strong back.
10. Lift slowly and follow your head and shoulders. Hold the load close to your body. Lift by extending your legs with your back straight, and breathe out as you lift.

For additional information on the recommended weight limit (23 kg | 50lbs) that can be lifted safely at different vertical and horizontal distances please see the associated chart located in the Appendix of this Specification.

Uncontrolled Copy if Printed or Downloaded

Internal Information

Workers are discouraged to manually lift or carry loads weighing in excess of 45 kg (99lbs) or weights they are not comfortable lifting by themselves. Where possible utilize a dolly, cart, pallet jack or similar. Where feasible, lifting aids (lift tables, mechanical or powered assists, hoists, etc.) should be used to move heavy or bulky loads.

Where a worker is required to manually lift or carry loads in excess of 45 kg (99lbs), a field level hazard assessment must be completed prior to task commencement.

4.0 REFERENCES

Applications Manual for the Revised NIOSH Lifting Formula, January 1994

Canada Occupational Health and Safety Regulations - SOR/86-304 (Section 14.46 | 14.49)

Ergonomics: The Study of Work

OSHA Protocol for Developing Industry and Task Specific Ergonomic Guidelines

5.0 APPENDIX

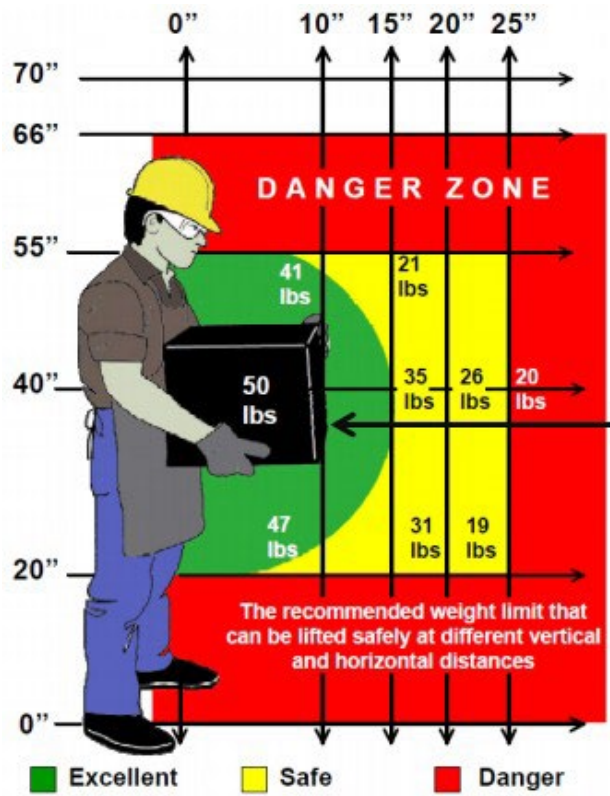



Contractor Safety Specification

Flagging and Warning Signs

Table of Contents

1.0	Definitions & Acronyms.....	2
2.0	Contractor Responsibilities	2
3.0	Specification Requirements	2
3.1	Flagging Tape	3
3.2	Flagging Tag	4
3.3	Warning Signs.....	4
3.4	Specialized Work.....	5
3.5	Flagging and Barricade Removal.....	5
4.0	References.....	6

1.0 DEFINITIONS & ACRONYMS

Applicable Legislation—All federal, provincial, state and municipal laws, regulations, codes, by-laws, ordinances or otherwise that are applicable to the jurisdiction in which the work is conducted including, but not limited to the Canada Labour Code, OSHA, State OSHA, Provincial and Territorial OH&S

Barricade—an obstruction to deter the passage of persons or vehicles.

Field level hazard assessment (FLHA)—A tool used just prior to the start of work to identify, assess and control the field-based hazards of the work being performed, and site or environmental conditions that may adversely affect the work (e.g. icy conditions, simultaneous operations, pedestrians).

Flagging tape—Colored, non-adhesive ribbon used for tagging, roping off, or other marking applications.

Hazardous area—an area in which there is significant potential for a flammable or toxic atmosphere to be present or develop.

Qualified worker—one who, by possession of a recognized degree, certificate, or professional standing, or who by knowledge, training and experience, has successfully demonstrated his ability to solve or resolve problems relating to the subject matter, the work, or the project.

Safe Work permit—an agreement between the permit issuer and receiver that is used to authorize work for a specific time and location and to ensure a safe area of work for the working group.

Safety watch—a qualified worker responsible for monitoring work activities to ensure safe work practices are followed, to identify hazards, to alert workers of hazardous conditions and to initiate emergency response procedures.

2.0 CONTRACTOR RESPONSIBILITIES

Contractors shall:

- Ensure that workers under their control are aware of and comply with this specification;
- Confirm that all requirements of the safe work permit/FLHA and/or work authorization are being followed.
- Ensure placement and removal of flagging and barricades as required; and
- Be aware of the hazard and exercise caution before crossing into a flagged off or barricaded area.

3.0 SPECIFICATION REQUIREMENTS

The basic use of flagging tape is to warn people of general hazards prior to their exposure.

Flagging tape will be placed in a location to provide sufficient warning to workers to protect them from the hazard. Workers are not to cross flagging tape without permission from those who installed it.

In certain situations, flagging tape is not adequate to control entrance into a hazardous area such as:

- Open trenches;
- Excavation areas;
- Floor openings; and/or
- Areas where handrails have been removed.

In these situations, it is necessary to install additional fall protection controls to prevent personnel from falling or otherwise being injured.

3.1 FLAGGING TAPE

Flagging tape shall be used as a warning to workers of hazards that exist in work areas. Flagging tape shall be:

- Installed to completely encompass the work area containing the potential hazard, including access from levels above or below;
- Prominently placed when conditions or activities may or do present a hazard to workers or the public;
- Placed to ensure workers cannot enter the area where the hazard exists, without prior knowledge of the hazard; and
- Removed when the potential hazard no longer exists.

Workers shall not enter flagged or barricaded areas until they:

- Obtain permission to enter the controlled area;
- Understand the hazards within the area by signing onto the field level hazard assessment; and
- Take necessary safety precautions.

The following types of flagging shall be used:

- **RED**—"Danger Do Not Enter"—Red with black lettering. This type of flagging is used where there is danger of an imminent hazard, such as crane lift zones, leaks, or a potential for falling objects. Only workers directly involved in the work are allowed in these areas. All others must obtain prior permission from the flagging owner (i.e. worker who installed the flagging) and sign onto the field level hazard assessment prior to entering the area.

- YELLOW—"Caution"—Yellow with black lettering. Yellow flagging is used to identify an area where a hazard exists that may cause injury or harm. Individuals may enter yellow flagged areas if they first read the associated tag and are aware of the hazards present and follow required control measures associated with the stated hazard.

3.2 FLAGGING TAG

A flagging tag shall be attached to all flagging tape. Multiple tags may be required depending on work area and hazards. The worker installing the tape shall complete the tag with the following information:

- Name of the person who installed the flagging;
- Phone number or radio channel for contact;
- Date on which the flagging was installed; and
- Reason for the use of flagging.

Instead of flagging or barricades, a safety watch may be used to prevent workers from entering the hazardous area, but only if the area is small enough to be easily managed and the safety watch remains in place until the hazard no longer exists.

3.3 WARNING SIGNS

Warning signs identifying known hazards shall be posted to warn workers and others in the area of the specific hazard. All signs shall be constructed in a professional manner and shall meet applicable legislation installation standards.

Warnings signs include, but are not limited to:

- Directional signs:
 - Installed as required,
- "No Trespassing," "Open Ditch" or "Danger/Open Excavation",
- The signs shall be:
 - Posted as appropriate to ensure visibility as required to all personnel accessing the ROW;
 - Face the intersecting road/highway, where construction activities are being conducted;
 - Display a contact telephone number for unauthorized workers to contact.

- Construction warning signs:
 - All crossings of any interstate, highway, municipal or private roads shall be posted with construction warning signs, which are designed and positioned in accordance with the requirements of the applicable legislation. Such signs shall be clearly visible to traffic, as appropriate to the crossing, e.g., visible from two or more directions,
- High pressure testing signs:
 - Shall be posted:
 - At all entries to the ROW, public access points and facility buildings while sections are under test;
 - Facing intersecting roads/highways.
- Smoke warning signs:
 - Warning signs shall be used to warn traffic of poor visibility due to smoke from brush burning operations. All such warning signs shall be in accordance with applicable legislation.
- Other warning signs shall be erected as required by applicable legislation or by Company to warn workers and/or the public of a range of potential hazards such as:
 - Traffic Hazards (e.g., STOP, slow, curve, steep hill, noise hazards, caution, work crews ahead, suggested speed restrictions, trucks turning, work in/over navigable waters);
 - Signs indicating venting in progress during any venting activities;
 - “Caution: Open Hole” or similar when there is an opening;
 - Overhead hazards;
 - Respiratory hazards; and
 - PPE requirements (e.g., hard hat, hearing protection, eye protection).

3.4 SPECIALIZED WORK

Where specialized work such as asbestos removal, lead abatement, or radiation work is being performed, access is restricted to all persons unless they are qualified to be in the area and signed in on the safe work permit.

3.5 FLAGGING AND BARRICADE REMOVAL

Barricading or flagging tape material will be taken down immediately following the removal of the hazard.

The same job position or person(s) who installed it or anyone associated with the task being protected, upon conclusion of the job, are responsible for taking it down.

4.0 REFERENCES

Occupational Safety and Health Administration (OSHA)

- Safety Color Code for Marking Physical Hazards - 1910.144
- Specifications for Accident Prevention Signs and Tags - 1910.145

<END OF DOCUMENT>



Contractor Safety Specification

Hazard Communication & WHMIS

Table of Contents

1.0	Definitions & Acronyms.....	2
2.0	Contractor Responsibilities	2
3.0	Specification Requirements	3
3.1	Availability of the HCP.....	3
3.1.1	Non-Routine Tasks Requirement.....	3
3.1.2	Company Obligations to Contractors	4
3.1.3	Contractor Obligations.....	4
3.1.4	Hazardous Chemical Inventory	4
3.1.5	Safety Data Sheets (SDS) & Label/Warning Requirements.....	5
4.0	References.....	5
5.0	Appendix.....	7
5.1	Appendix 1: HMIS and NFPA SDS and Label Requirements (US).....	7
5.2	Appendix 2: WHMIS SDS and Label Requirements (CAN)	13

1.0 DEFINITIONS & ACRONYMS

Applicable Legislation—All federal, provincial, state and municipal laws, regulations, codes, bylaws, ordinances or otherwise that are applicable to the jurisdiction in which the work is conducted including, but not limited to the Canada Labour Code, OSHA, State OSHA, Provincial and Territorial OH&S.

Ceiling Occupational Exposure Limit—An Exposure Limit which should not be exceeded at any time.

Enbridge—Enbridge, Inc. and Enbridge (U.S.) Inc., hereinafter will be referred to as “Company”.

Exposure Limit—Workplace standard below which is believed that nearly all normal and healthy Workers may be repeatedly exposed, day after day, for working lifetime without adverse health effects.

Permissible Exposure Limit (PEL)—An occupational health standard instituted to safeguard Workers against exposure to toxic material in the workplace.

Person in Charge (PIC) – The most senior ranking worker in the work area who has control over the work and activities of the work.

Safety Data Sheet (SDS)—A Safety Data Sheet (SDS), previously called a Material Safety Data Sheet (MSDS), is a document that provides information on the properties of hazardous chemicals and how they affect H&S in the workplace.

Short Term Exposure Limit (STEL)—A 15-minute Time Weighted Average (TWA) exposure limit that should not be exceeded at any time during a workday even if the overall 8-hour TWA is within limits, and it should not occur more than 4 times per day. There should be at least 1 hour between successive exposures.

Threshold Limit Value (TLV)—Occupational exposure limit set by the American Conference of Governmental Industrial Hygienists (ACGIH) under which it is believed that nearly all Workers may be repeatedly exposed, day after day, over a working lifetime, without adverse health effects.

Time Weighted Average (TWA) Exposure Limit—The average exposure a contaminant for an individual over a given working period determined by sampling at given times during the period. Unless otherwise mentioned, TWA is the concentration of contaminants measured over an 8-hour period.

2.0 CONTRACTOR RESPONSIBILITIES

Contractor shall:

- Maintain facility Hazardous Chemical Inventory in a location readily accessible to all workers and or visitors.

- Review work to determine what hazardous chemicals may be encountered by either the contractor or company workers.
- Ensure that PPE is provided as necessary to employees working with hazardous chemicals.
- Ensure that chemical containers on Company property are properly labeled.
- Assessing the method of control to insure that OSHA PELs or ACGIH TLVs are not exceeded.
- Obtain and maintain SDS for all of the hazardous chemicals currently being used in their workplace.
- Use appropriate PPE provided for working with hazardous chemicals.
- Review SDS for chemicals used in job tasks.
- Personal hygiene – worker is responsible to wash exposed skin promptly to remove accidental splashes of hazardous material.
- Workers must review the SDS before using a chemical for the first time.
- Ensure all hazardous chemicals used and stored in the workplace are properly labeled or marked.
- Ensure that the labels, markings and other forms of warning are:
 - Legible
 - In English (US)
 - In English and French (CAN)
 - Prominently displayed on the container

3.0 SPECIFICATION REQUIREMENTS

3.1 AVAILABILITY OF THE HCP

The Company recognizes that a Hazard Communication Program (HCP) is made available and accessible to all workers. A list of known hazardous materials shall be available on request to any worker.

3.1.1 NON-ROUTINE TASKS REQUIREMENT

Before workers start a non-routine task which involves working with a hazardous material, the Contractor will provide the workers with information about the hazardous material to which they may be exposed to while performing the task.

3.1.2 COMPANY OBLIGATIONS TO CONTRACTORS

During the contractor safety orientation, the PIC will provide the contractor employees with at least the following basic information:

- Location of the facility chemical list and SDS binder.
- Details of the labeling system used in the facility.
- Physical and health hazards of materials to which the contractor employees may be exposed to during normal operations.
- Any precautionary measures that need to be taken to protect contractor employees.
- Emergency and evacuation procedures.
- PPE required.
- Safe handling procedures.

3.1.3 CONTRACTOR OBLIGATIONS

During the contractor safety orientation, the Contractor Supervisor will provide the PIC with at least the following basic information:

- Notification prior to bringing any hazardous materials on Company property.
- Copy of SDSs for any hazardous materials the contractor is bringing on site.
- The labeling system the contractor uses.
- Any precautionary measures that need to be taken to protect company employees.
- The safe storage and handling procedures the contractor will use.

A contractor cannot bring hazardous material containers onto company property unless those containers are properly labeled.

Any hazardous material brought onto the site by the contractor must be properly removed by the contractor.

3.1.4 HAZARDOUS CHEMICAL INVENTORY

The Contractor shall maintain a Hazardous Chemical Inventory of all chemicals brought to the Company location and shall be readily accessible to all workers and or visitors. The Hazardous Chemical Inventory should contain at the least the following basic information:

- Chemical name (as written on the SDS)
- Chemical supplier name (phone number & address optional)
- Chemical HMIS (US) hazard ratings or WHMIS (CAN) classification

Uncontrolled Copy if Printed or Downloaded

- Chemical use (inhibitor, treating, cleaning, etc.)
- Chemical storage method (tank, drum, bottle, etc.)
- Volume of chemical normally kept on site

3.1.5 SAFETY DATA SHEETS (SDS) & LABEL/WARNING REQUIREMENTS

The Contractor is responsible for obtaining and maintaining SDS for all of the hazardous chemicals currently being used in their workplace.

- If an SDS does not accompany a new chemical, the PIC must contact the vendor for immediate delivery of the SDS.
- Workers must review the SDS before using a chemical for the first time.
- Workers should be familiar with all of the SDS for the chemicals used in their work place.
- All SDS's and labels must meet regulatory requirements (eg. GHS & HMIS (US) and WHMIS (CAN)). *See Appendix 1-2 for specific SDS, labeling and warning requirements.*
- Be sure that all outdated SDS for chemicals currently being used are replaced with the most up-to-date SDS.

4.0 REFERENCES

Association Advancing Occupational and Environmental Health (ACGIH)

- Threshold Limit Values for Chemical Substances and Physical Agents

Canada Occupational Health and Safety Regulation (COHSR)

- Part X – Hazardous Substances

Department of Transportation (DOT)

- 49 CFR 100.185 Hazardous Materials Transportation

National Fire Protection Agency (NFPA)

- Part 30 Flammable & Combustible Liquids Code

National Institute of Occupational Safety and Health (NIOSH)

- Pocket Guide to Hazardous Materials

Occupational Safety and Health Administration (OSHA)

- 29 CFR 1926.59 Hazard Communications
- 29 CFR 1910.1200 Hazard Communications
- 29 CFR 1910.1450 Hazardous Materials in Laboratories

Transportation of Dangerous Goods (TDG) Act and TDG Regulations

Workplace Hazardous Materials Information System (WHMIS) 2015 – News Hazardous Products Regulations Requirements, Hazardous Product Act and Hazardous Products Regulations

5.0 APPENDIX

5.1 APPENDIX 1: HMIS AND NFPA SDS AND LABEL REQUIREMENTS (US)

Hazard Communication Safety Data Sheets

The Hazard Communication Standard (HCS) requires chemical manufacturers, distributors, or importers to provide Safety Data Sheets (SDSs) (formerly known as Material Safety Data Sheets or MSDSs) to communicate the hazards of hazardous chemical products. As of June 1, 2015, the HCS requires new SDSs to be in a uniform format, and include the section numbers, the headings, and associated information under the headings below:

- Section 1, Identification includes product identifier; manufacturer or distributor name, address, phone number; emergency phone number; recommended use; restrictions on use.
- Section 2, Hazard(s) identification includes all hazards regarding the chemical; required label elements.
- Section 3, Composition/information on ingredients includes information on chemical ingredients; trade secret claims.
- Section 4, First-aid measures includes important symptoms/effects, acute, delayed; required treatment.
- Section 5, Fire-fighting measures lists suitable extinguishing techniques, equipment; chemical hazards from fire.
- Section 6, Accidental release measures lists emergency procedures; protective equipment; proper methods of containment and cleanup.
- Section 7, Handling and storage lists precautions for safe handling and storage, including incompatibilities.
- Section 8, Exposure controls/personal protection lists OSHA's Permissible Exposure Limits (PELs); ACGIH Threshold Limit Values (TLVs); and any other exposure limit used or recommended by the chemical manufacturer, importer, or employer preparing the SDS where available as well as appropriate engineering controls; personal protective equipment (PPE).
- Section 9, Physical and chemical properties lists the chemical's characteristics.
- Section 10, Stability and reactivity lists chemical stability and possibility of hazardous reactions.
- Section 11, Toxicological information includes routes of exposure; related symptoms, acute and chronic effects; numerical measures of toxicity.
- Section 12, Ecological information*
- Section 13, Disposal considerations*

-
- Section 14, Transport information*
 - Section 15, Regulatory information*
 - Section 16, Other information, includes the date of preparation or last revision.









*Note: Since other Agencies regulate this information, OSHA will not be enforcing Sections 12 through 15 (29 CFR 1910.1200(g)(2)).

See Appendix D of 1910.1200 for a detailed description of SDS contents.

TABLE 1

Hazard	NFPA	HMIS® III			
Flammability	4	a. Rapidly or completely vaporize under ambient conditions b. Readily dispersed in air c. Will burn readily	a. Flammable gases or very volatile liquids with flash point below 73°F & boiling point < 100 F b. May ignite spontaneously with air		
	3	Ignited under ambient conditions	a. Capable of ignition under almost all ambient conditions b. Liquids with flash points below 73 °F & boiling points > 100 °F c. Liquids flash point 73 °F to 100 °F		
	2	Must be moderately heated before ignition can occur	a. Moderately heated or exposed to high ambient temperatures before ignition b. Liquids flash point 100 °F to 200 °F		
	1	Must be preheated before ignition can occur	a. Must be preheated before ignition b. Liquids, solids, semi solids with flash point >200°F		
	0	Will not burn	Materials that will not burn		
Health Hazard		Concerned with acute health hazards only.	* Asterisk: if present indicates a chronic health hazard		
	4	Under Emergency Conditions (UEC) can be lethal	a. Life-threatening b. Major or permanent damage may result from single or repeated overexposures		
	3	UEC can cause serious or permanent injury	Major injury likely unless prompt action is taken and medical treatment is given		
	2	UEC can cause temporary incapacitation or residual injury	Temporary or minor injury may occur		
	1	UEC can cause severe irritation	Irritation or minor reversible injury possible		
	0	UEC would offer no hazard beyond ordinary combustible materials	No significant risk to health		
Reactivity (NFPA)	4	a. Capable of detonation b. Explosive decomposition c. Explosive reaction at normal temperatures & pressures	Physical Hazard (HMIS® III)	4	a. Explosive water reaction b. Detonation or explosive decomposition, polymerization c. Self-reaction at ambient conditions
	3	a. Capable of detonation b. Explosive decomposition c. Explosive reaction with strong initiation source or heated under confinement		3	a. May form explosive mixture in water b. Detonation or explosive reaction in the presence of strong initiating source c. May polymerize, decompose, self-react d. May undergo chemical change at ambient with moderate risk of explosion
	2	Violent chemical change at elevated temperatures & pressures		2	a. Unstable and may undergo violent chemical changes at ambient with low risk for explosion b. May react violently with water. c. May form peroxides upon exposure to air
	1	Unstable at elevated temperatures		1	a. Can become unstable at high temperature & pressure b. May react non-violently with water c. May undergo hazardous polymerization in absence of inhibitors
	0	Normally stable even under fire conditions		0	a. Normally stable, even under fire b. Will not react with water, polymerize, decompose, condense, or self-react

Special Handling & Personal Protection	NFPA Special Handling		HMIS® III Personal Protection			
	OX	Oxidizer	A			
B						
ACID	Acid	C				
		D				
ALK	Alkali	E				
		F				
COR	Corrosive	G				
		H				
		I				
W	Use no water	J				
		K				
Ask your Supervisor for special handling instructions						

<p>Health Hazard</p>  <ul style="list-style-type: none"> • Carcinogen • Mutagenicity • Reproductive Toxicity • Respiratory Sensitizer • Target Organ Toxicity • Aspiration Toxicity 	<p>Flame</p>  <ul style="list-style-type: none"> • Flammables • Pyrophorics • Self-Heating • Emits Flammable Gas • Self-Reactives • Organic Peroxides 	<p>Exclamation Mark</p>  <ul style="list-style-type: none"> • Irritant (skin and eye) • Skin Sensitizer • Acute Toxicity (harmful) • Narcotic Effects • Respiratory Tract Irritant • Hazardous to Ozone Layer (Non-Mandatory)
<p>Gas Cylinder</p>  <ul style="list-style-type: none"> • Gases Under Pressure 	<p>Corrosion</p>  <ul style="list-style-type: none"> • Skin Corrosion/ Burns • Eye Damage • Corrosive to Metals 	<p>Exploding Bomb</p>  <ul style="list-style-type: none"> • Explosives • Self-Reactives • Organic Peroxides
<p>Flame Over Circle</p>  <ul style="list-style-type: none"> • Oxidizers 	<p>Environment (Non-Mandatory)</p>  <ul style="list-style-type: none"> • Aquatic Toxicity 	<p>Skull and Crossbones</p>  <ul style="list-style-type: none"> • Acute Toxicity (fatal or toxic)

Hazard Communication Labels

Hazard Communication Standard Labels OSHA has updated the requirements for labeling of hazardous chemicals under its Hazard Communication Standard (HCS). All labels are required to have pictograms, a signal word, hazard and precautionary statements, the product identifier, and supplier identification. A sample revised HCS label, identifying the required label elements, is shown below.

SAMPLE LABEL

Product Identifier

CODE _____
Product Name _____

Supplier Identification

Company Name _____
Street Address _____
City _____ State _____
Postal Code _____ Country _____
Emergency Phone Number _____

Precautionary Statements

Keep container tightly closed. Store in a cool, well-ventilated place that is locked.
Keep away from heat/sparks/open flame. No smoking.
Only use non-sparking tools.
Use explosion-proof electrical equipment.
Take precautionary measures against static discharge.
Ground and bond container and receiving equipment.
Do not breathe vapors.
Wear protective gloves.
Do not eat, drink or smoke when using this product.
Wash hands thoroughly after handling.
Dispose of in accordance with local, regional, national, international regulations as specified.

In Case of Fire: use dry chemical (BC) or Carbon Dioxide (CO₂) fire extinguisher to extinguish.

First Aid
If exposed call Poison Center.
If on skin (or hair): Take off immediately any contaminated clothing. Rinse skin with water.

Hazard Pictograms

Signal Word
Danger

Hazard Statements

Highly flammable liquid and vapor.
May cause liver and kidney damage.

Supplemental Information

Directions for Use

Fill weight: _____ Lot Number: _____
Gross weight: _____ Fill Date: _____
Expiration Date: _____

5.2 APPENDIX 2: WHMIS SDS AND LABEL REQUIREMENTS (CAN)

HPR specifies the sections and content for the SDS as follows:

SDS Section and Heading		Specific Information Elements
1	Identification	<ul style="list-style-type: none"> • Product identifier (e.g. Product name) • Other means of identification (e.g. product family, synonyms, etc.) • Recommended use • Restrictions on use • Canadian supplier identifier+ <ul style="list-style-type: none"> ○ Name, full address and phone number(s) • Emergency telephone number and any restrictions on the use of that number, if applicable
2	Hazard identification	<ul style="list-style-type: none"> • Hazard classification (class, category) of substance or mixture or a description of the identified hazard for Physical or Health Hazards Not Otherwise Classified • Label elements: <ul style="list-style-type: none"> ○ Symbol (image) or the name of the symbol (e.g., flame, skull and crossbones) ○ Signal word ○ Hazard statement(s) ○ Precautionary statement(s) • Other hazards which do not result in classification (e.g., molten metal hazard)
3	Composition/Information on ingredients	<ul style="list-style-type: none"> • When a hazardous product is a material or substance: <ul style="list-style-type: none"> ○ Chemical name ○ Common name and synonyms ○ Chemical Abstract Service (CAS) registry number and any unique identifiers ○ Chemical name of impurities, stabilizing solvents and/or additives* • For each material or substance in a mixture that is classified in a health hazard class**: <ul style="list-style-type: none"> ○ Chemical name ○ Common name and synonyms ○ CAS registry number and any unique identifiers ○ Concentration <p>NOTE: Confidential business information rules can apply</p>
4	First-aid measures	<ul style="list-style-type: none"> • First-aid measures by route of exposure: <ul style="list-style-type: none"> ○ Inhalation ○ Skin contact ○ Eye contact ○ Ingestion • Most important symptoms and effects (acute or delayed) • Immediate medical attention and special treatment, if necessary
5	Fire-fighting measures	<ul style="list-style-type: none"> • Suitable extinguishing media • Unsuitable extinguishing media • Specific hazards arising from the hazardous product (e.g., hazardous combustion products) • Special protective equipment and precautions for fire-fighters
6	Accidental release measures	<ul style="list-style-type: none"> • Personal precautions, protective equipment and emergency procedures • Methods and materials for containment and cleaning up

7	Handling and storage	<ul style="list-style-type: none"> • Precautions for safe handling • Conditions for safe storage (including incompatible materials)
8	Exposure controls/ Personal protection	<ul style="list-style-type: none"> • Control parameters, including occupational exposure guidelines or biological exposure limits and the source of those values • Appropriate engineering controls • Individual protection measures (e.g. personal protective equipment)
9	Physical and chemical properties	<ul style="list-style-type: none"> • Appearance (physical state, colour, etc.) • Odour • Odour threshold • pH • Melting point/Freezing point • Initial boiling point/boiling range • Flash point • Evaporation rate • Flammability (solid; gas) • Lower flammable/explosive limit • Upper flammable/explosive limit • Vapour pressure • Vapour density • Relative density • Solubility • Partition coefficient - n-octanol/water • Auto-ignition temperature • Decomposition temperature • Viscosity
10	Stability and reactivity	<ul style="list-style-type: none"> • Reactivity • Chemical stability • Possibility of hazardous reactions • Conditions to avoid (e.g., static discharge, shock, or vibration) • Incompatible materials • Hazardous decomposition products
11	Toxicological information	<p>Concise but complete description of the various toxic health effects and the data used to identify those effects, including:</p> <ul style="list-style-type: none"> • Information on the likely routes of exposure (inhalation, ingestion, skin and eye contact) • Symptoms related to the physical, chemical and toxicological characteristics • Delayed and immediate effects, and chronic effects from short-term and long-term exposure • Numerical measures of toxicity
12	Ecological information***	<ul style="list-style-type: none"> • Ecotoxicity • Persistence and degradability • Bioaccumulative potential • Mobility in soil • Other adverse effects
13	Disposal considerations***	Information on safe handling for disposal and methods of disposal, including any contaminated packaging
14	Transport information***	<ul style="list-style-type: none"> • UN number

		<ul style="list-style-type: none"> • UN proper shipping name • Transport hazard class(es) • Packing group • Environmental hazards • Transport in bulk, if applicable • Special precautions
15	Regulatory information***	Safety, health and environmental regulations specific to the product
16	Other information	Date of the latest revision of the SDS

+The supplier that must be identified on an SDS is the initial supplier identifier (i.e., the name, address and telephone number of either the Canadian manufacturer or the Canadian importer). There are two exceptions to this requirement. In a situation where a hazardous product is being sold by a distributor, the distributor may replace the name, address and telephone number of the initial supplier with their own contact information. In a situation where an importer imports a hazardous product for use in their own workplace in Canada (i.e., the importer is not selling the hazardous product), the importer may retain the name, address and telephone number of the foreign supplier on the SDS instead of replacing it with their own contact information.

*These impurities and stabilizing products are those that are classified in a health hazard class and contribute to the classification of the material or substance.

**Each ingredient in the mixture must be listed when it is classified in a health hazard class and is present above the concentration limit that is designated for the hazard class in which it is classified or is present in the mixture at a concentration that results in the mixture being classified in any health hazard class.











***Sections 12 to 15 require the headings to be present, but under Canadian regulations, the supplier has the option to not provide information in these sections.

Pictograms and Hazards

Pictograms are graphic images that immediately show the user of a hazardous product what type of hazard is present. With a quick glance, you can see, for example, that the product is flammable, or if it might be a health hazard.

Most pictograms have a distinctive red "square set on one of its points" border. Inside this border is a symbol that represents the potential hazard (e.g., fire, health hazard, corrosive, etc.). Together, the symbol and the border are referred to as a pictogram. Pictograms are assigned to specific hazard classes or categories.

The graphic below shows hazard pictograms. The bold type is the name given to the pictogram; the words in the brackets describe the hazard.

	Exploding bomb (for explosion or reactivity hazards)		Flame (for fire hazards)		Flame over circle (for oxidizing hazards)
	Gas cylinder (for gases under pressure)		Corrosion (for corrosive damage to metals, as well as skin, eyes)		Skull and Crossbones (can cause death or toxicity with short exposure to small amounts)
	Health hazard (may cause or suspected of causing serious health effects)		Exclamation mark (may cause less serious health effects or damage the ozone layer*)		Environment* (may cause damage to the aquatic environment)
	Biohazardous Infectious Materials (for organisms or toxins that can cause diseases in people or animals)				

* The GHS system also defines an Environmental hazards group. This group (and its classes) was not adopted in WHMIS 2015. However, you may see the environmental classes listed on labels and Safety Data Sheets (SDSs). Including information about environmental hazards is allowed by WHMIS 2015.

Supplier Labels

Supplier labels must be written in English and French. They may be bilingual (as one label), or available as two labels (one each in English and French).



The supplier label must include the following information:

1. **Product identifier** – the brand name, chemical name, common name, generic name or trade name of the hazardous product.
2. **Initial supplier identifier** – the name, address and telephone number of either the Canadian manufacturer or the Canadian importer*.
3. **Pictogram(s)** – hazard symbol within a red "square set on one of its points".
4. **Signal word** – a word used to alert the reader to a potential hazard and to indicate the severity of the hazard.
5. **Hazard statement(s)** – standardized phrases which describe the nature of the hazard posed by a hazardous product.
6. **Precautionary statement(s)** – standardized phrases that describe measures to be taken to minimize or prevent adverse effects resulting from exposure to a hazardous product or resulting from improper handling or storage of a hazardous product.
7. **Supplemental label information** – some supplemental label information is required based on the classification of the product. For example, the label for a mixture containing ingredients with unknown toxicity in amounts higher than or equal to 1% must include a statement indicating the percent of the ingredient or ingredients with unknown toxicity. Labels may also include supplementary information about precautionary actions, hazards not yet included in the GHS, physical state, or route of exposure. This information must not contradict or detract from the standardized information.

* Initial supplier identifier – There are two exceptions to this requirement:

- In a situation where a hazardous product is being sold by a distributor, the distributor may replace the name, address and telephone number of the initial supplier with their own contact information.
- In a situation where an importer imports a hazardous product for use in their own workplace in Canada (i.e., the importer is not selling the hazardous product), the importer may retain the name, address and telephone number of the foreign supplier on the SDS instead of replacing it with their own contact information.

An example of a bilingual label is shown below:

Product K1 / Produit K1	
 	
Danger Fatal if swallowed. Causes skin irritation. Precautions: Wear protective gloves. Wash hands thoroughly after handling. Do not eat, drink or smoke when using this product. Store locked up. Dispose of contents/containers in accordance with local regulations. IF ON SKIN: Wash with plenty of water. If skin irritation occurs: Get medical advice or attention. Take off contaminated clothing and wash it before reuse. IF SWALLOWED: Immediately call a POISON CENTRE or doctor. Rinse mouth.	Danger Mortel en cas d'ingestion. Provoque une irritation cutanée. Conseils : Porter des gants de protection. Se laver les mains soigneusement après manipulation. Ne pas manger, boire ou fumer en manipulant ce produit. Garder sous clef. Éliminer le contenu/récipient conformément aux règlements locaux en vigueur. EN CAS DE CONTACT AVEC LA PEAU : Laver abondamment à l'eau. En cas d'irritation cutanée : Demander un avis médical/consulter un médecin. Enlever les vêtements contaminés et les laver avant réutilisation. EN CAS D'INGESTION : Appeler immédiatement un CENTRE ANTIPOISON ou un médecin. Rincer la bouche.
Compagnie XYZ, 123 rue Machin St, Mytown, ON, N0N 0N0 (123) 456-7890	

Workplace label will require the following information:

- Product name (matching the SDS product name).
- Safe handling precautions, may include pictograms or other supplier label information.
- A reference to the SDS (if available).

Workplace label requirements fall under your provincial or territorial jurisdiction, or under the Canada Labour Code if you work in a federally regulated workplace. Again, watch for confirmation, updates, or changes to these requirements when the WHMIS regulations in your jurisdiction are updated.

<End of Document>



Contractor Safety Specification

Hazard Assessment & Control

Table of Contents

1.0	Definitions & Acronyms.....	2
2.0	Contractor Responsibilities	3
3.0	Specific Requirements	3
3.1	Hazard Assessments	3
3.2	Hierarchy of Controls	4
3.3	Types of Hazard Assessments	5
3.3.1	Job Hazard Assessment	5
3.3.2	Field Level Hazard Assessment.....	5
3.3.3	Facility Hazard Assessment (FHA).....	6
3.3.4	Project and Contractor Hazard Assessments	7
3.4	Hazard Assessment Workflows	8
3.5	Tools for Identifying, Analyzing and Registering Hazards.....	9
3.5.1	Energy Wheel Hazard Identification Methodology.....	9
3.6	Communicating Hazards.....	9
4.0	References.....	10
5.0	Appendix.....	11
5.1	Field Level Hazard Assessment.....	11
5.2	Job Hazard Assessment	13

1.0 DEFINITIONS & ACRONYMS

ALARA— *As low as reasonably achievable.*

Contractor - A legal entity with whom the Company may enter into an agreement for the provision of labor, materials and/or equipment by the Contractor in the delivery of a specified scope.

Critical Task—A task which has the potential to produce major loss to people, property, process and/or environment when not performed properly.

CTA—Critical Task Analysis is a systematic review of a specific task to break down tasks with the goal of identifying and controlling hazards per task steps.

Enbridge – Enbridge, Inc and Enbridge (U.S.) Inc., hereinafter will be referred to as “Company”.

FLHA—Field Level Hazard Assessment is a hazard assessment completed at the immediate work site that assesses the hazards associated with the environmental conditions, nearby work, small tasks or hazards that could not be identified during the planning stages of jobs.

Hazardous Area— An area in which concentrations of flammable gases, flammable liquid-produced vapors, or combustible liquid produced vapors can exist under normal operating conditions.

Hazard—Source or situation with a potential for harm in terms of injury, ill health, damage to property, damage to workplace and environment, or any other definitions as set out by regulations and codes

Job Hazard Assessment—A Hazard Assessment completed in the planning phase of a job to identify and evaluate hazards in order to eliminate or control them.

Procedure—A step-by-step description of how to proceed, from start to finish, in performing a task properly.

Risk—Effect of uncertainty on objectives; characterized by reference to events, sources and consequences; expressed in terms of a combination of the consequences of an event and the associated likelihood.

Site Safety Plot Plan—Site-specific drawing that shows hazardous and restricted areas, primary evacuation site, secondary evacuation site, helicopter landing areas and the location of safety facilities and equipment (e.g., evacuation alarms, wind socks, fire extinguishers and first aid stations).

SWP—Safe Work Permit.

Task—Segment of work which requires a set of specific and distinct actions for its completion.

2.0 CONTRACTOR RESPONSIBILITIES

Contractor Management shall ensure:

- Workers are trained to assess potential and existing hazards specific to their work activities including hazard identification, assessment and control;
- Hazard assessments of work activities and worksites are completed as required, and where reasonably practicable, everyone involved in a work activity participates in the respective hazard assessment for that work;
- Documentation and retention of hazard assessments as per document retention requirements;
- Known and potential safety hazards inherent to the facility are recognized, assessed and controlled (captured/documented);
- Hazard assessments are communicated to all workers involved in work activity;
- Everyone involved in a work activity participates in completing or reviewing the respective hazard assessment for that work;
- Appropriate use of the required hazard assessment tools;
- Periodic review and assessments of in-progress work to ensure that the tools are adequate to identify the hazards, and the controls implemented have reduced the risk associated with the work to ALARA levels;
- Workers and work groups involved in the work have acknowledged the hazard assessment outputs (hazards and controls) and these are put to practical use during work execution;

Workers shall:

- Complete hazard assessment of work activities and worksites as required;
- Understand the hazard assessment process and specific responsibilities as they apply to each worker; and
- Participate actively in the hazard assessment process while ensuring that an appropriate level of recognition, assessment and control is completed before the start of all work.

3.0 SPECIFIC REQUIREMENTS

3.1 HAZARD ASSESSMENTS

A Hazard Assessment is required and shall be documented for all work activities, except:

- Office related work (e.g. computer use, training, meetings);
- Travel between work locations; and/or

- Light housekeeping.

These exceptions do not take away a worker's responsibility to assess hazards. Workers shall continue to practice cognitive hazard assessment techniques (e.g. stop, look, assess, and manage).

Hazard assessments shall include all workers involved with the work and are most effective when completed in the planning phase of work. The results of the assessment shall be communicated to all other workers who may be affected by the work.

3.2 HIERARCHY OF CONTROLS

A hierarchy of intervention methods is presented below in the order of priority. In situations with multiple hazards or causal factors, a combination of control methods may be warranted.

- 1.0 Process Elimination—means elimination of non-value added processes, job tasks, motion, transportation and uncomfortable layouts. Elimination may be achieved by design/redesign, modifications or different approaches, e.g., lifting down sample cans from workstations and lifting them up to the trucks may be eliminated by using a cart.
- 2.0 Substitution—means substituting a new work process or tool for a work process or tool with no or less identified hazards. Substitution serves to eliminate the hazard. For example, hand tools that require awkward wrist positions such as extreme wrist flexion, extension or deviation can be replaced with tools that allow a neutral wrist posture.
- 3.0 Engineering Controls—changes are made to the workstations, tools and/or machinery that alter the physical composition of the human-machine interface or process so that the risk factors are eliminated or reduced.
- 4.0 Administrative controls—means controls used to limit the duration, frequency and severity of exposure to work-related hazards. Examples of administrative controls include, but are not limited to: providing rest breaks, doing stretching exercises, providing opportunities for job enrichment, limiting overtime work and instituting job rotation.
- 5.0 Personal Protective Equipment (PPE)—PPE may be used as an interim measure to control work-related hazards, but must not be used as a permanent control when other controls are feasible.

Hazard controls require planning of work to ensure itemization of specific work steps, identification of the hazards associated with each work step and placement of controls to either eliminate or control hazards to ALARA. The hazard assessment tools are effective at identifying engineering and administrative controls, which can be developed as a part of the planning phase thereby reducing the reliance on PPE as the primary means of control at a worksite.

3.3 TYPES OF HAZARD ASSESSMENTS

A Field Level Hazard Assessment is the most basic level of Hazard Assessment. If the same hazards exist for a work scope or a task, instead of repeating them daily on the FLHA, create a JHA and then review the Job Hazard Assessment. Please see the detailed descriptions for these requirements and the process flows for a visualization of this process.

The Company uses several distinct types of hazard assessments to identify, assess and control hazards associated with the design, construction, operation and maintenance of the company facilities and assets. This includes:

- Job Hazard Assessments (JHA)
- Field Level Hazard Assessment (FLHA)
- Facility Hazard Assessment (HSA)

3.3.1 *JOB HAZARD ASSESSMENT*

The Job Hazard Assessment (JHA) outlines controls for hazards associated with specific jobs or tasks. These controls may be specific to a task, or reference standards and procedures to be followed at certain points in a job. The JHA is meant to identify hazards and assess controls that potentially need to be planned out in advance during the planning phase of work (working in darkness, electrical hazards, lifting, etc.).

This may include jobs where there will be multiple work groups involved and multiple tasks completed. Work planning tools for complex multi-faceted jobs and other non-routine work where exposure to open systems, high voltage electrical work or other high potential Hazards exist have JHA's built into the planning tool and do not require a standalone JHA. Once a JHA has been completed as part of a planning tool it should be reviewed prior to starting work.

For workers that conduct routine tasks daily, where the hazards associated with that task do not change and the controls are the same on a day to day basis, complete a JHA for that workers job role by task that can be reviewed prior to starting work. Completion of this JHA should capture the hazards that are inherent to the work that are mitigated through procedures, specialized PPE and administrative controls that will not vary on a day to day basis. JHAs for these job roles should be kept on site and available for daily use. If a JHA has not been created for a particular task within a job role, the hazard assessment for that task can be captured on the FLHA until such time as the JHA has been completed.

3.3.2 *FIELD LEVEL HAZARD ASSESSMENT*

The FLHA tool is used daily by all workers at the immediate work site, just prior to work execution. This hazard assessment process will be documented using the FLHA tool.

The distinguishing factor between an FLHA and other hazard assessment tools is that it is used to identify unforeseen, newly developed, or changing hazards at the immediate work

site. It is a field tool, meant for and to be used to recognize, identify and control hazards that are immediately apparent or foreseeable as a result of workers being present in the task location. The intent of the FLHA is to identify, communicate, and document hazardous energy sources that may adversely affect the work (e.g. motion, gravity, mechanical, electrical, pressure, chemical, biological, temperature, radiological, noise) as well as any items that are unique to the task environment that may cause a variable to work conditions.

A FLHA may cover individual or group work provided the group is performing the same task. All workers performing the work shall participate in the FLHA discussion and completion. Any additional workers joining the work activity shall review, attempt to identify additional hazards and controls, and acknowledge (sign) the active FLHA. If workers begin a new task in a new area, a new FLHA shall be required. If the same scope of work will be completed in a new area, review and update the FLHA to any new site hazards

When a FLHA is required, it shall be completed and acknowledged (signed) by all involved workers prior to task commencement. If needed, the existing FLHA may be reviewed and updated as work changes throughout the shift providing the defined and permitted scope of work does not change.

All work that requires an SWP requires an associated FLHA for the scope of work covered by the SWP. If scope of work changes for any permit-required work, a new FLHA shall be completed. The FLHA should be reviewed prior to returning to work after a prolonged (i.e. more than 1 hour) work break.

Contractor developed FLHA tools and process will be accepted after review from the Company representative overseeing the task (or designate). If it is not acceptable and the Company FLHA is to be used, a Company representative shall ensure the contractor is versed in the use of the Energy Wheel FLHA (see Section 3.5.1).

3.3.3 FACILITY HAZARD ASSESSMENT (FHA)

All facilities and stations owned and/or operated by Company are assessed for hazards inherent to the facility and its operations under normal operating conditions. FHAs shall be conducted for stations and terminals and be inclusive of all buildings and assets within the facility.

The assessment includes taking into account:

- The nature of the Hazard,
- The controls in place to address the hazard.

This shall be documented on the facility hazard assessment. Post the FHA at the facility in conjunction with the site safety plot plans. This FHA is reviewed by the operating group at each facility every two years or as required based on facility/process changes, upgrades or additions and are updated as necessary to ensure they remain current. Use the facility

hazard assessment to assist with orientations and training, completing Hazard Assessments, or communicating site Hazards.

3.3.4 PROJECT AND CONTRACTOR HAZARD ASSESSMENTS

Contractors will be required to complete hazard assessments to identify any known hazards applicable/unique to their work activities. Contractors shall complete a JHA for all general work activities that don't have a procedure. A copy of any completed hazard assessments for the project shall be provided to Company for review prior to site mobilization. Key items and outputs from the hazard assessments should be provided to workers during contractor or site-specific orientation. This review with workers is a critical component of the hazard assessment process and shall be completed prior to beginning work on site.

For brownfield sites, Company shall provide a copy of the appropriate facility hazard assessment to the contractor outlining additional hazards associated with the facility that the contractor could see on the site.

Based on the scope and complexity of a project, a project safety plan shall be completed by the contractor prior to work beginning on Company sites. Contractors with sizeable, complex or multiple scopes will be required to complete a project safety plan. The Company representative (or designee) planning and/or overseeing the work reserves the right, at their discretion, to request hazard assessments are completed as part of that project safety plan and Company will provide the contractor with written request prior to work commencement.

3.4 HAZARD ASSESSMENT WORKFLOWS

The following work flows will be followed for operations and project activities:

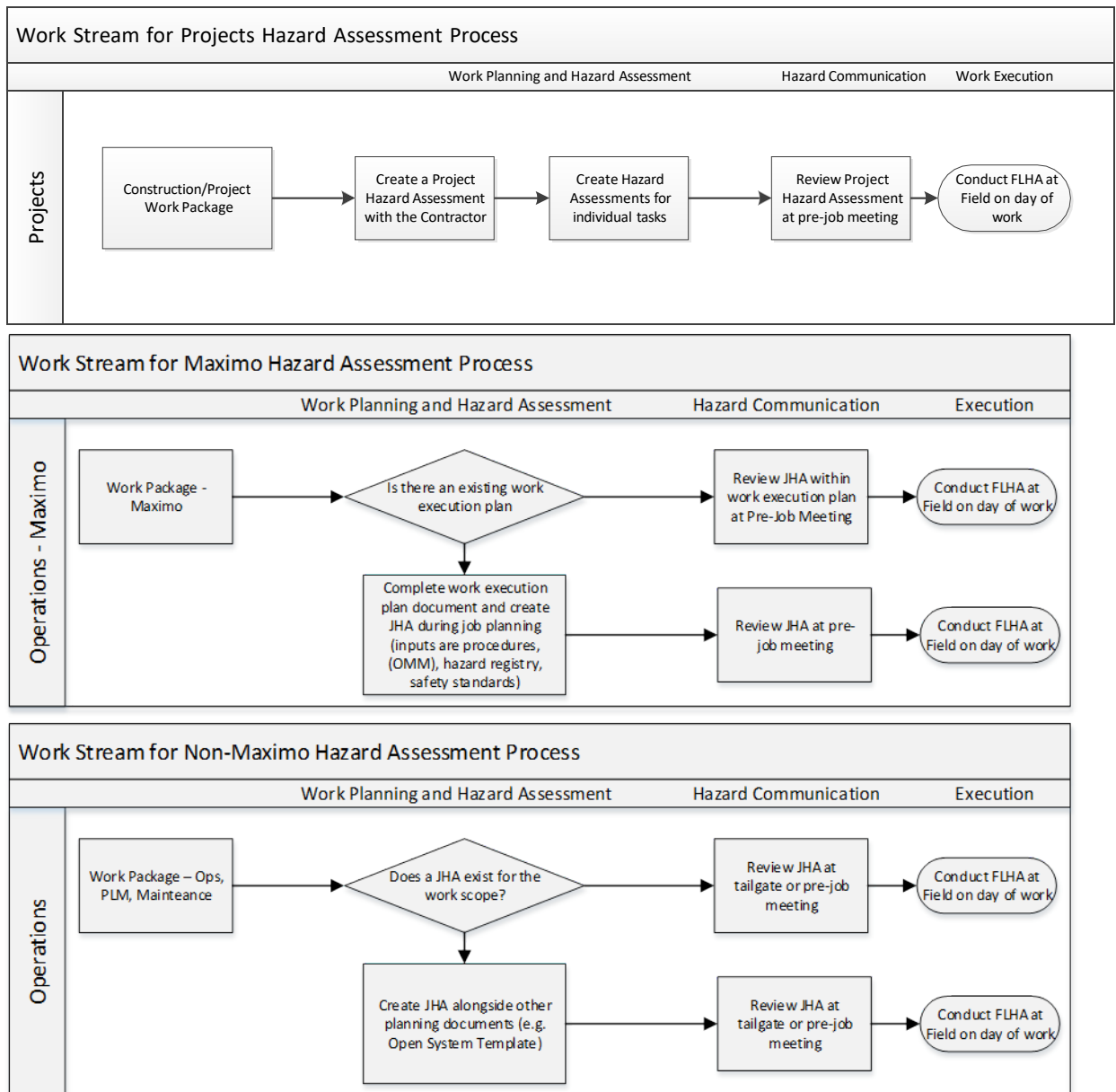

3.5 TOOLS FOR IDENTIFYING, ANALYZING AND REGISTERING HAZARDS

3.5.1 ENERGY WHEEL HAZARD IDENTIFICATION METHODOLOGY

The main hazard recognition methodology used is the Energy Wheel. This wheel is representative of the various forms of energy that pose potential to cause harm to people, property or assets. The energy wheel is used as a hazard recognition aid when conducting Hazard Assessments at both the planning and work execution phases.

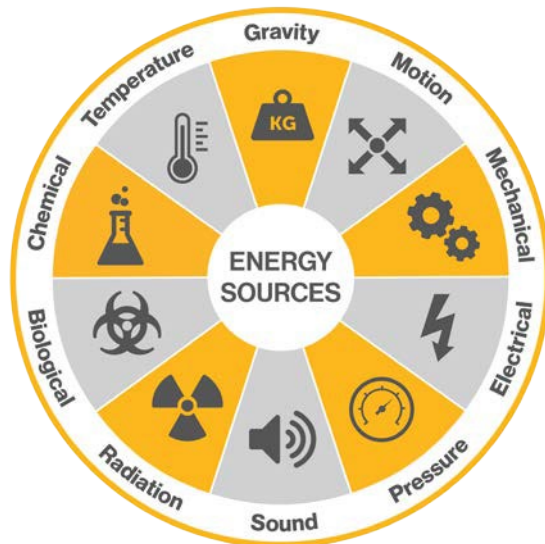

3.6 COMMUNICATING HAZARDS

The most effective way for communication hazards to the frontline is directly engaging with the workers who will be performing the work. Outside of this hazard assessment process, there are additional methods which support communicating hazards to frontline personal. This includes but is not limited to:

- Site Safety Orientations
- Site safety orientations shall be used to communicate site specific hazards to contractors and visitors to site. Safety Orientations shall be conducted annually for contractors and visitors to a site.
- Tailgate Meetings and Pre-job Meetings shall be held to review and discuss the identified hazards and controls on the Hazard Assessment tools

4.0 REFERENCES

- Canada Labour Code, Part II – Occupational Health & Safety
- 124 Duties of Employers
- 125 Duties of Employees
- 135 Work Place Health & Safety Committees
- 136 Health & Safety Representatives
- Canadian Occupational Safety & Health (COSH) regulations
- Part XIX Hazard Prevention Program
- Occupational Safety and Health Administration (OSHA)
- Hazard Communication, 29 CFR 1910.1200

5.2 JOB HAZARD ASSESSMENT

		Job Hazard Assessment		Associated Documents or permits (JPT, SWP, CSE):
Job/Project:			Prepared by:	Date:
Tasks	Sub-Task	Potential Hazards Associated With Task or Sub-Task		Administrative Controls, Engineering Control or other mitigations.

SAMPLE

HAZARDS BY ENERGY TYPE	Gravity Hazards <ul style="list-style-type: none"> Fall under six feet Falls over six feet Overhead work Excavation/cave-in Falling Load Climbing ladders Fall from same level Inadequately rated rigging Tools falling from height Loss of traction Slippery surfaces Dropped objects Unstable Position Mechanical Hazards <ul style="list-style-type: none"> Sharp edges Rotating equipment Pinch/nip points Power tool use Crush Point Unguarded equipment Pressure <ul style="list-style-type: none"> Compressed Chemicals Stored energy/pressure Trapped Pressure in Piping Pneumatic Pressure Hydraulic Pressure Explosion Pressurized Piping Hydrates Thermal expansion 	Motion Hazards <ul style="list-style-type: none"> Line of fire Mobile equipment Struck by/object Caught in between Unstable position Limited Access/egress Congested area Simultaneous Operations Buried facilities Load shifting Vehicle Movement on site High speed traffic Minimal Clearance Unanticipated startup of equipment Heavy/lateral loads Overexertion Vibration Overreaching Manual lifting Repetitive motions Inadequate Lighting High Winds Limited Visibility 	Sound <ul style="list-style-type: none"> Loud vehicles Loud Tools/Equipment Loud environments Loud Equipment Pump Shutter Purging (Nitrogen) Pressure Relief Systems Electrical Hazards <ul style="list-style-type: none"> Electric Shock – Low Voltage Electric Shock – High Voltage Arc Flash/Blast Induced voltage Non-intrinsically safe tools/equipment Adapter cords Static electricity Energized Electrical Equipment (LEL – Normal/Abnormal Operating Conditions) Stored Electrical Energy Fire electrical Cathodic Protection Overhead Power Lines Underground Cables 	Chemical <ul style="list-style-type: none"> Explosive/flammable Corrosive Oxidizing agents Acute/chronic toxicity Highly reactive Skin/eye irritants Hazardous Atmosphere Drowning Ignition sources Chemical Exposure Vapors Battery Acid Exhaust fumes Welding Fumes Air Quality Material Compatibility Chemical Reaction Pesticides Lack of Ventilation Radiation <ul style="list-style-type: none"> X-raying Naturally Occurring Radioactive Material (NORM) Densitometer Gamma radiation (subburn) Welding flash Infrared Scanners 	Temperature <ul style="list-style-type: none"> Extreme cold Extreme Heat Chemical Reaction Wind chill Hot Surfaces (Friction/Heat) Cold Surfaces (Nitrogen, NGL, Propane) Ignition Sources Dry Conditions Damp/Wet Conditions Snow/Ice Lack of Ventilation Biological <ul style="list-style-type: none"> Plant Animals Birds Reptiles Insect Mold Bloodborne Pathogens Asbestos Silica Bacteria Viruses 	Human Factors <ul style="list-style-type: none"> Knowledge/Skill Deviation from Plan Communication Risk Tolerance Fit for Duty Worker Fatigue New/inexperienced workers Working alone Remote access to ER Personal Limitations
CONTROLS	<ul style="list-style-type: none"> System de-pressurized Purge/ventilate lines Gas detection Ventilation Energy isolation/LOTO Fire watch Fire extinguisher Spark containment Intrinsically safe equipment GFCIs Fall protection plan Fall arrest Fall restraint Exclusion zone Barricade/Guardrail 	<ul style="list-style-type: none"> Scaffolding Ladders/stairs Mechanical lifting Rescue equipment Grounding/bonding Utility location Trench box/shoring Proper excavation Ground leveling/planking Rig matting First aid kit Eye wash station Continuous air monitoring Emergency Shower Three point contact 	<ul style="list-style-type: none"> Adaptation Grounding/ear protection Small kit Warning signs Warning flagging Inspection (area, tools) Proper body placement Spotters/safety watch Signage Emergency notification Man down pendants Procedure/practice review Machine guarding Whip checks Specific work procedure 	<ul style="list-style-type: none"> Work/rest cycles Restricted work hours SME support Worker rotation Communication plan Extraction/rescue plan Electrical safe approach Access to SDS Proper disposal of waste Task Specific Training Lift Plan Confined Space Rescue Plan Review Drawing Welding screen Fire blanket Tag lines 	<ul style="list-style-type: none"> Goggles Face shield Hearing protection Protective footwear Slip resistant footwear Arc flash PPE FR clothing Specific Gloves for task Fire extinguisher Equipment pre-use inspection Rigging load rating checked Warning signs 	<ul style="list-style-type: none"> High visibility vest Personal Flotation Devices Chemical clothes, boots Respiratory protection <ul style="list-style-type: none"> 1/2 mask full face Cartridge Supplied air SCBA



Contractor Safety Specification

Hoisting and Rigging

Table of Contents

1.0	Definitions & Acronyms.....	2
2.0	Contractor Responsibilities	2
3.0	Specification Requirements	3
3.1	Classification of Lifts.....	4
3.1.1	Critical Lifts.....	4
3.1.2	Engineered Critical Lifts.....	5
3.1.3	Serious Lift	5
3.1.4	Standard Lifts	5
3.2	Lift Planning	6
3.3	Lift Requirements	7
3.4	Rigging and Hoisting Requirements.....	7
3.5	Inspection and Maintenance	8
3.6	Lifting and Support Component Requirements and Formal Inspection.....	9
3.6.1	Blocking and Cribbing	9
3.6.2	Hooks	9
3.6.3	Slings, Chains, Ropes, Cables.....	10
3.6.4	Hoist Chains	11
3.6.5	Taglines.....	11
3.6.6	Jacks	11
4.0	References.....	12
5.0	Appendix.....	13
5.1	Lift Plan	13
5.2	Lift Data Sheet	14
5.3	Critical Lift Plan Form.....	15
5.4	Pre-Lift Safety Checklist.....	16

1.0 DEFINITIONS & ACRONYMS

Competent worker—Means one who is capable of identifying existing and predictable hazards in the surroundings or working conditions which are unsanitary, hazardous, or dangerous to workers, and who has authorization to take prompt corrective measures to eliminate them.

Enbridge—Enbridge, Inc. and Enbridge (U.S.) Inc., hereinafter will be referred to as “Company”.

High Voltage—Over 750 volts [CAN] or 600 volts [USA].

Lift—To hoist, lower and horizontally move a suspended load.

Lift Coordinator—The person designated to direct the overall work scope.

Lift Plan—Information and/or instruction used in support of a load handling activity.

Load Handling Equipment (LHE)—Equipment used to move a load. (e.g. cranes, hoists, etc.) NOTE—this definition does not apply to Excavation Equipment used for lifting and Sidebooms. For additional guidance refer to the Powered Mobile Equipment Specification.

Qualified—One who, by possession of a recognized degree, certificate, or professional standing, or who by knowledge, training and experience, has successfully demonstrated his ability to solve or resolve problems relating to the subject matter, the work, or the project.

Qualified Lift Engineer—Responsible for providing any required engineering support and documentation for the load handling activity (generally provided by the contractor).

Working Load Limit (WLL)—The maximum working load specified by the manufacturer.

2.0 CONTRACTOR RESPONSIBILITIES

Contractor Management:

- Ensure that all workers are aware of and comply with this Specification;
- Perform spot checks to ensure field compliance of the Specification;
- Assign appropriate individuals to rigging and hoisting activities.

Qualified operators shall:

- Be trained with the LHE they are about to operate;
- Ensure procedures applicable to the operation of the equipment are readily available in the cab at all times;
- Ensure a permanently-attached load and radius chart can be easily read from their operating position;
- Verify weight of the load (including load and rigging);
- Shall have experience consistent with the requirements of the lift to be made;

- Are qualified for their task;
- Shall provide documentation of training records and certifications upon request; and
- Assign appropriate individuals to rigging and hoisting activities.

Qualified rigger/rigging specialists shall:

- Be trained as per applicable legislation;
- Have experience consistent with the requirements of the lift to be made;
- Be competent for their task;
- Provide documentation of training records and certifications upon request;
- Perform equipment inspections, as per manufacturer specifications, to verify that the lifting device and all components are in safe working condition.
- Maintain a written record or log book of these inspections.
- Note: A Qualified Operator shall be used in jurisdictions that don't certify Riggers.

Signalers shall:

- Be qualified in hoisting and rigging hand signals;
- Complete any specific training required by applicable legislation and/or as required by the company in charge of the lift;
- Wear appropriate PPE to distinguish themselves from other workers (i.e., Gauntlet);
- Halt operations if a person enters an area under a suspended lift/ enters area between a stationary object and a suspended load; and
- Observe and communicate on the movement of the LHE and load.

Lift Coordinators shall:

- Be the qualified person in charge of the lift; and
- Facilitate all pre-lift meetings for serious and critical lifts.

3.0 SPECIFICATION REQUIREMENTS

When hoisting, lowering or moving a load vertically or horizontally with the LHE, the following factors shall be considered or determined:

- Percent of equipment capacity;
- Weight of the load;
- Any change or transition of critical workers, as identified in the lift plan;

- Ground conditions;
- Compaction of soil;
- Overhead lines, obstructions, etc.;
- Underground facilities or Hazards;
- Trajectory of load if dropped (i.e., determine the potential drop zone);
- Electrical equipment in the area, e.g., nearby conductors or overhead power lines;
- Weather conditions;
- Outrigger and track loading;
- Matting;
- Process operations and local process hazards;
- Workers near the lift area; and
- Multi-lift plans.

Controls shall be identified based on the conditions determined given the circumstances of the lift to be performed.

3.1 CLASSIFICATION OF LIFTS

Lifts shall be classified in the following types to determine the requirements for controls:

- Critical;
- Serious; and
- Standard.

3.1.1 CRITICAL LIFTS

The workers involved in a critical lift shall apply the required controls and any other appropriate measures to ensure the safe and effective execution of the lift.

Lifts classified as critical lifts include:

- Any LHE lift, when the load is greater than 75% of the manufacturer's rating chart;
- Any tandem lift (multi-LHE lift) involving two or more LHE lifting the same load simultaneously, when the load may exceed more than 75% of the lifting capacity of any one LHE, as measured on the manufacturer's rating chart; and
- Any lift where the load travels over or between overhead High Voltage power lines (this does not include cables in cable trays).

The minimum control measure required for all critical lifts is the completion of a critical lift plan (CLP).

The CLP shall be signed and approved by a qualified rigger/rigging specialist and/ or qualified equipment operator.

3.1.2 ENGINEERED CRITICAL LIFTS

An engineered critical lift plan (ECLP) may be used based on the level of risk identified in the hazard assessment by the Company regional manager/project manager in consultation with the contractor.

A qualified lift engineer shall visit the site of the lift to familiarize themselves with all above and below grade facilities in order to create a comprehensive engineered critical lift plan.

The ECLP shall be reviewed and agreed to by all workers involved in the lift at the pre-lift meeting. The ECLP shall be signed and approved by a qualified equipment operator and a qualified rigger/rigging specialist (when applicable).

3.1.3 SERIOUS LIFT

The workers involved in a serious lift shall apply the required controls and any other appropriate measures to ensure the safe and effective execution of the lift.

Lifts classified as serious lifts include any:

- Crane lift where workers are being hoisted in a man-basket;
- Lift where failure of the lift could endanger existing Facilities of one-of-a-kind equipment or processes;
- Load where non-routine lifting or rigging equipment configurations are used;
- Lift where the load or any part of the LHE could come within the safe limits of approach to High Voltage equipment or a power line;
- Lifts over existing permanent structures; and
- Blind lift.

For each serious lift, the minimum control measure required shall be completion of a serious lift plan (SLP).

3.1.4 STANDARD LIFTS

A standard lift is any lift that is not classified as serious or critical. Details around the lift shall be documented on a hazard assessment (JHA and/ or FLHA) and discussed with workers involved in the lift. The details documented should include records of weight, radius and percentage of chart for each lift, or for a series of lifts from a single location (as applicable).

3.2 LIFT PLANNING

For serious and critical lifts, the minimum control measure required shall be completion of a lift plan. The lift plan shall be reviewed, agreed to, and signed off by all workers involved in the lift at the pre-lift meeting.

At a minimum, the information recorded on the serious or critical lift plan shall include:

- Weight;
- Radius;
- Equipment type;
- Percentage of load chart;
- Rigging components;
- Rating capacities; and
- Adequate clearances to prevent contact with site-specific hazard(s) or obstructions during load handling activities.

In addition to the requirements of the Serious Lift Plan, the CLP shall include:

- Equipment layout and swing path schematic;
- Rig arrangement schematic; and
- Lift sequence.

A pre-lift meeting shall be held for all serious and critical lifts. At a minimum, the pre-lift meeting shall review:

- The lift plan with all parties involved with the lift;
- Identified traveled path(s) of the load and LHE;
- Hazards and controls associated with the work area;
- Identification of the Qualified Rigger (when applicable) and signaler to other workers involved;
- Agreed upon lift hand signals;
- Agreed upon means of communication between the operator and signaler if the equipment operator cannot see the load or the signaler (if applicable);
- Identified and marked the swing radius (if applicable);
- The lift zone and all potential drop zones;
- The requirement to not walk or pass under a suspended load or enter the area between the load and a stationary object; and
- Complete the pre-lift checklist (located in the appendix) for serious or critical lifts.

Note: Multiple lift rigging, commonly known as “Christmas-tree” lifting shall not be performed at Company locations.

3.3 LIFT REQUIREMENTS

When performing any lift, the lift coordinator and operator shall:

- Ensure barricades and warning signs are in place to control traffic in the work area;
- Ensure warning tape or an exclusion zone is made around the swing radius of the counter weight;
- Ensure loads are not moved, carried or swung over the head of any worker;
- Avoid traveling with loads suspended. If travel is necessary, ensure loads are secured to control the load swing (i.e., taglines used);
- Keep loads as close to the ground as reasonably possible;
- Ensure the operator remains at the controls while loads are suspended;
- Ensure a safe distance from the load is maintained until the tension on the rigging is relaxed and the load is stable;
- Ensure all workers are clear of the load being lifted;
- Stop all operations if someone enters the area under a suspended load/ area between a stationary object and a suspended load; and
- Stabilize the load, and assess and mitigate the hazards to allow for final fit-up by hand if required.

All workers involved in the lift have the responsibility to suspend operations when any of the following occur:

- The wind velocity exceeds the crane’s limit specified by the manufacturer;
- The ambient temperature is below that specified by the manufacturer;
- Severe environmental conditions are present; and
- Any other hazard creates an unsafe working condition.

3.4 RIGGING AND HOISTING REQUIREMENTS

Qualified Operator shall ensure that all rigging and hoisting meet the following requirements:

- All lifting devices and components shall be of sufficient size and strength to support the weight of the load, and that they do not exceed the manufacturer’s recommendations under any circumstances;

- Kept in good working order in accordance with manufacturer's specifications;
- Used in accordance with manufacturer's specifications;
- Ensure the hoist is free to swivel on hooks;
- Rig loads over 3.6 m (12 ft.) long at a minimum of 2 points, more points may be required depending on load distribution and load shape;
- Attach the load to the hook by slings or other approved lifting devices;
- Set up to rig the hoist directly over the load based on center of gravity of the load;
- The working load limit (WLL) of the hoist shall not exceed the WLL of the foundation and structural supports that the equipment is on;
- The load chain or hoist cable is free from kinks and twists, and is not wrapped around the load;
- All lifting devices shall be properly assembled using the appropriate rigging component as required for the intended lift (e.g., four-part line vs. a two-part line);
- The load, sling, lifting device and load block shall clear all obstructions;
- Ensure equipment (e.g., boom) stays within the safe limits of approach to electrical lines and conductors, in accordance with the hazard assessment and/or lift plan;
- A test lift is conducted to assess the center of gravity so that the rigging can be re-positioned as needed;
- All hoisting lines shall be placed in a vertical position over the center of gravity, in such a manner as to reduce danger to workers from a swing or uncontrolled movement of the load. Dynamic loading impacts the capacity of the crane; and
- Tension is maintained on the rigging and that the rigging is not unhooked until the load is fully secured.

Material lifting structures, hoists and rigging components shall be clearly marked with the WLL.

Markings shall:

- Be legible and visible on the LHE; and
- Be in contrasting color to the LHE.

3.5 INSPECTION AND MAINTENANCE

All LHE shall be installed, operated, inspected, maintained and repaired according to the manufacturer's specifications.

A written inspection and maintenance program for LHE shall be in place to ensure that equipment and components are in safe operating condition.

All load bearing components shall undergo non-destructive testing in accordance with the manufacturer's specifications.

Equipment shall be inspected before each lift.

Follow these additional maintenance and inspection requirements:

- The manufacturer's specifications shall be followed when assembling/disassembling equipment, under the direction of a qualified worker;
- Modifications or additions that may affect the capacity or safe operation of the equipment shall be made only with the written approval of the manufacturer; and
- Inspection records are required for each lifting device.

All written records including all certifications, maintenance records, and inspection records for LHE, e.g., cranes, hoists, and side booms shall be made available to a Company representative for review upon request.

3.6 LIFTING AND SUPPORT COMPONENT REQUIREMENTS AND FORMAL INSPECTION

Lifting components shall be kept in good working order and a formal inspection completed in accordance with manufacturer's specifications by a person qualified to complete the inspection. All components found to be deficient or defective shall be tagged and removed from service.

3.6.1 BLOCKING AND CRIBBING

When blocking and cribbing, workers shall:

- Use appropriate materials for cribbing;
- Use solid layers of timber for heavy loads;
- As needed, use steel or hardwood mats under cribbing to spread the bearing pressure evenly (e.g., if the ground has insufficient load bearing capabilities);
- Use load-rated manufactured pipe support; and
- Ensure stability in cribbing:
 - The height of cribbing should not exceed the length of the cribbing material.

3.6.2 HOOKS

Hooks shall not be overloaded. All hooks used for lifting shall have a safety latch.

The hook's safety latch shall:

- Be closed, and shall not support any part of the load;

- Not be damaged or bent;
- Operate with enough spring pressure to keep the latch tightly against the top of the hook; and
- Spring back to the top when released.

Replace hooks (including the nut) if the any of the following conditions are observed:

- Cracking;
- Excessive wear/deformities/twisting;
- Throat opening has increased 15% or more; and
- Twist out of the normal hook plane.

Approved pipe hooks (sorting hooks) that are designed without safety latches are exempt from the requirements outlined immediately above.

3.6.3 SLINGS, CHAINS, ROPES, CABLES

Slings (including rope and cable slings) used for lifts shall:

- Have softeners added where sharp corners contact the sling;
- Be at a 45° angle or more;
- Be flat (i.e., not twisted, kinked or knotted) while in use;
- Be connected in a way that provides control of the load;
- Avoid shock loading;
- Not be dragged on the floor or over abrasive surfaces;
- Not be pulled from under a load when the load is resting on the sling;
- Be stored out of the elements (sunlight, rain, snow, etc.) and in accordance with manufacturers' specifications;
- Be the correct size for the hook and shall be seated in the saddle of the hook; and
- Be inspected, used and stored according to the manufacturer's specifications.

A competent worker shall visually inspect slings before use. The worker shall also ensure slings and accessories:

- Have not been damaged in storage or shipment;
- Are clearly labeled and/or tagged;
- Are rated for hoisting, indicating the manufacturer's ratings and the safe working limits;

- Are the correct type and have the proper capacity rating for the application; and
- Are removed from service and discarded if they're defective or are showing signs of damage or excessive wear.

3.6.4 HOIST CHAINS

Hoist chains shall have a name plate with all relevant information legible and shall be used and inspected as per manufacturers' specifications. Chains used for overhead lifting shall be Grade 80 or better. Welded chains shall not be used. A competent worker shall inspect the chains link by link for:

- Nicks;
- Gouges;
- Twisted links; and
- Excessive wear or stretching.

3.6.5 TAGLINES

Taglines shall be used to protect workers from being in the line of fire while allowing them the ability to manipulate the load from a safe distance. As such, tag lines shall be attached when rotation or swinging of the load is hazardous, or when the load needs guidance

Multiple tag lines may be used when rotation or uncontrolled motion of a load being hoisted is anticipated.

At a minimum, tag lines shall:

- Be inspected before each lift and removed from service if defective; and
- Be attached directly to the load.

During the lift, tag lines shall not:

- Be used if they create an unsafe condition as determined by the Hazard Assessment; and
- Be wrapped or secured in any form to a worker.

3.6.6 JACKS

Jacks shall:

- Only be used for temporary support of loads;
- Be supported by a firm level foundation;
- Not be used at an angle; and
- Lift loads from one end at a time, not from side to side.

External hydraulic jack pumps shall be positioned a safe distance from the load being lifted.

Discard or repair jacks if visual inspection reveals any of the following:

- Hydraulic fluid leaks;
- Thread damage;
- Scoring or other damage to the ram;
- Excessively loose or frozen swivel heads;
- Damaged end caps;
- Cracks or other damage to the housing; and
- Loose bolts or rivets.

4.0 REFERENCES

OSHA Standards

- Part 1910.176 Handling materials—general.
- Part 1910.184 Slings.
- Part 1926 - Safety and Health Regulations for Construction
- Part 1926.251 Rigging equipment for material handling

Canada Labour Code, Part II:

- Canadian Occupational Safety & Health (COSH) regulations, Part XIV Materials Handling

ASME Standard P30.1-2014, Planning for Load Handling Activities

5.0 APPENDIX

5.1 LIFT PLAN

		LIFT PLAN	
Location on job / lift description: _____			
Date of lift: _____	Project # _____	Type of LHE _____	
Manufacturer: _____	Model# _____	Type of LHE _____	

LHE CHECKS	
Any deviation from level compact surface in area?	_____
Electrical hazards in the area?	_____
Obstacles or obstructions to lift and swing?	_____
Swing direction and degree (boom swing)	_____
LHE inspected by:	_____
Functional test of LHE by:	_____

LIFT ARRANGEMENT	PLANNED LIFT PATH	JIB
Lift radius _____ ft. (center pin of crane to center of lift)	<input type="checkbox"/> 360° <input type="checkbox"/> over front	Erected <input type="checkbox"/> Stored <input type="checkbox"/>
Boom length _____ ft.	<input type="checkbox"/> over rear <input type="checkbox"/> over side	Is Jib to be used: Yes <input type="checkbox"/> No <input type="checkbox"/>
Boom angle at lift _____ deg.	Lift path cleared?	Length of jib: _____ ft.
Boom angle at set _____ deg.	<input type="checkbox"/> yes <input type="checkbox"/> no	Angle of jib: _____ deg.
		Rated capacity of jib: _____ lbs.

RATED CAPACITY OF CRANE	LOAD LINE	WHIP LINE
360° _____ lbs.	Number of parts cable: _____	Number of parts cable: _____
Over side _____ lbs.	Size of cable: _____	Size of cable: _____
Over front _____ lbs.	Length _____	Length _____
Over rear _____ lbs.	lbs/ft _____	lbs/ft _____
	total weight: _____ 0 lbs	total weight: _____ 0 lbs

WEIGHT OF LIFT	SLING SELECTION
Weight of load: _____ lbs.	Type of arrangement
Weight of lifting beam: 0 lbs.	Size _____ 0 ea 0 cap 0 lbs
Weight of rigging _____ lbs.	Size _____ 0 ea 0 cap 0 lbs
Weight of auxiliary rigging: 0 lbs.	Size _____ 0 ea 0 cap 0 lbs
Additional weight:	Shackle selection
Headache ball/ Load-block _____ lbs.	Size _____ 0 ea 0 cap 0 lbs
Load line 0 lbs.	Size _____ 0 ea 0 cap 0 lbs
Whip line 0 lbs.	Size _____ 0 ea 0 cap 0 lbs
Jib deduction _____ lbs.	Weight of rigging: _____ 0 lbs
Allowance:	Auxiliary rigging
Unaccounted material 0 lbs.	Come-a-long _____ 0 ea 0 cap 0 lbs
Total weight: 0 lbs.	Chainfall _____ 0 ea 0 cap 0 lbs
	Other _____ 0 ea 0 cap 0 lbs
% of crane capacity: _____	Weight of auxiliary rigging: _____ 0 lbs

LIFT	
Critical Lift?	Serious Lift?
If lift is critical, complete the following: crane layout and swing path schematic, rig arrangement and lift sequence	
Source of load weight: _____	
Weights verified by: X	
Sketch Required! Unaccounted Material= 10%	
Special instructions or restrictions for crane, rigging, lift, etc. _____	
1 _____ Enbridge Rep	3 _____ Contractor Supervisor
2 _____ Operator reviewed	4 _____ Safety Representative

* Multiple crane lifts require a separate lift plan for each crane. Any change to crane, rigging, etc. require that a new plan be developed.

Version 1.0 (Revised YY-MM-DD) White Copy - Technical Review; Yellow Copy - Region Office; Retain in Regional Office for asset
Version 1.0 (Revised YYYY-MM-DD) White Copy - Region Office; Retain in Regional Office for asset +10 yrs

5.2 LIFT DATA SHEET

	Lift Data Sheet	
---	-----------------	--

CRANE LAYOUT (SCHEMATIC)

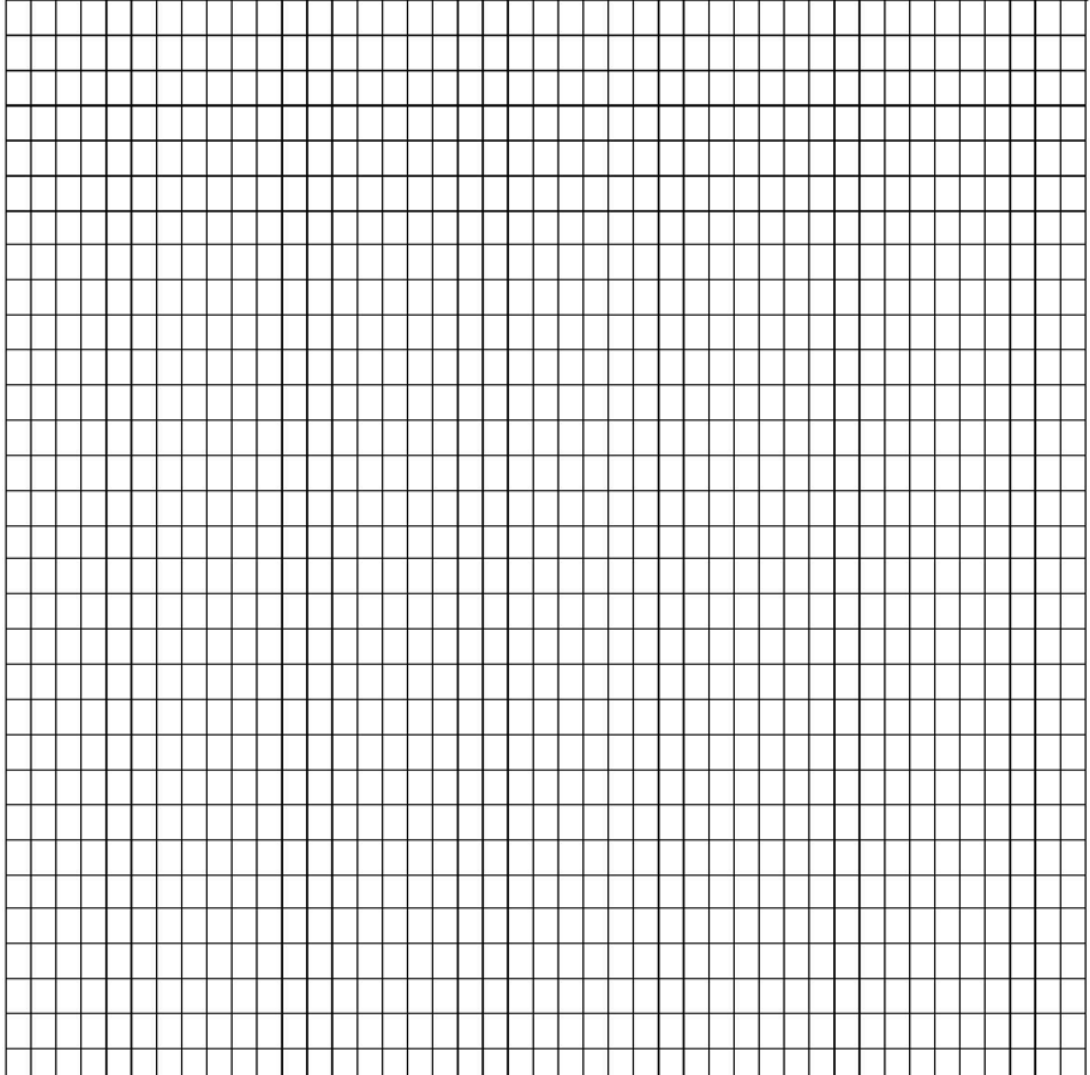



Contractor Safety Specification

Hot Work and Ignition Sources

Table of Contents

1.0	Definitions & Acronyms	2
2.0	Contractor Responsibilities	2
3.0	Specification Requirements	3
3.1	Hot Work	3
3.2	Fire Watch	3
3.2.1	Prevent Fire	4
3.2.2	Ensure the safety of the workers in the area.....	4
3.2.3	Safely suppress and/or extinguish the fire	4
3.2.4	Additional Responsibilities	5
3.3	Ignition Sources	6
3.3.1	Diesel-Powered Equipment - Spark Arrestors	7
3.3.2	Diesel-Powered Equipment – Positive Air Shut-Off Devices - USA.....	7
3.3.3	Diesel-Powered Equipment – Positive Air Shut-Off Devices - CANADA	8
3.3.4	Pyrophoric Iron Sulfide.....	8
3.4	Bonding & Grounding	9
3.4.1	Bonding Cables.....	10
3.5	Induced Voltage.....	11
3.6	Cutting and Welding.....	12
3.7	Cameras and Communication Equipment	12
3.8	Smoking and Firearms.....	12
4.0	References	13
5.0	Appendix.....	14
5.1	Table 1 Installing Bonding Cables	14

1.0 DEFINITIONS & ACRONYMS

Atmospheric monitoring—Continuous testing that details the atmospheric content of the worksite real time.

Bonding—connecting two objects together with metal, usually with a piece of copper wire. This bond prevents a difference in potential across the gap because it provides a conductive path through which the static charges can recombine. Therefore, no spark can occur.

Enbridge—Enbridge, Inc. and Enbridge (U.S.) Inc., hereinafter will be referred to as “Company”.

Grounding—connecting an object to earth with metal, usually copper wire. The connection to earth is usually made to a ground rod or underground water piping.

Hazardous area—an area in which concentrations of flammable gases, flammable liquid-produced vapors, or combustible liquid produced vapors can exist under normal operating conditions.

Hot work—any process that can be a source of ignition when flammable material is present or can be a fire hazard regardless of the presence of flammable material.

Qualified—one who, by possession of a recognized degree, certificate, or professional standing, or who by knowledge, training and experience, has successfully demonstrated his ability to solve or resolve problems relating to the subject matter, the work, or the project.

Restricted area—An area in which volatile flammable gases, flammable liquid– produced vapors, or combustible liquid–produced vapors are handled, processed, or used, but in which the liquids, vapors, or gases will normally be confined within closed containers or closed systems from which they can escape only in case of accidental rupture or breakdown of such containers or systems or in case of abnormal operation of equipment.

Safe work permit—an agreement between the permit issuer and receiver that is used to authorize work for a specific time and location and to ensure a safe area of work for the working group.

2.0 CONTRACTOR RESPONSIBILITIES

Contractor Management shall:

- Ensure that Contractor Workers and subcontractors under their control are aware of and comply with this Specification;
- Ensure competency of fire watch personnel prior to work commencement;
- Confirm that all requirements of the safe work permit are being followed: and
- Ensure that all required fire protection equipment and resources are readily available.

Fire watch workers shall:

- Protect workers by monitoring for applicable hazards during a work activity;

- Prevent fire, ensure the safety of the workers in the area and, if possible, safely suppress and/or extinguish the fire without endangering themselves or others; and
- Enact emergency response procedures.

Workers shall:

- Understand and implement expectations of the safe work permit;
- Knowledgeable of the hazardous and restricted zones within work environment; and
- Follow ignition source precautions and requirements within standard and field level hazard assessment.

3.0 SPECIFICATION REQUIREMENTS

3.1 HOT WORK

Prior to commencing hot work ensure:

- Hot work has been selected under work types on the safe work permit (SWP);
- All movable fire hazards are removed and combustible materials (e.g. oil, rags, gasoline, paper) are removed from the Hot Work area and placed a safe distance away from the hot work;
- Verification of a non-explosive environment with an atmospheric monitoring device;
- Ensure continuous monitoring of hot work area during hot work in hazardous and restricted areas and after the hot work has been complete;
- If fire hazards cannot be removed, then guards shall be used to confine heat, sparks and slag; and
- Fire extinguishers are in place as required by the *Emergency Preparedness -Personal Safety Specification*.

Monitor the environment during Hot Work to ensure an unknown or previously undetected flammable atmosphere does not develop.

3.2 FIRE WATCH

Fire watch are designated personnel that have the responsibility to prevent and/or react to emergency situations in the event of a fire. The primary responsibilities of a fire watch are to, if possible:

1. Prevent fire;
2. Ensure the safety of the workers in the area and, if possible; and
3. Safely suppress and/or extinguish the fire without endangering themselves or others.

Note: *If there are no line of site concerns and it is permissible by the hazard assessment or safety project plan, one individual can perform the duties of a safety watch and fire watch. Please contact the Company safety team for further direction.*

3.2.1 PREVENT FIRE

- Verify that all necessary hazard screenings, work authorizations, fire prevention plans, and/or safe work permits are in place prior to work commencement;
- Review the requirements of the safe work permit and ensure that;
- All workers have reviewed prior to hot work commencement;
- Verify that pre-use inspections have been completed on the following:
 - Fire suppression equipment (i.e. fire extinguisher);
 - Ventilation equipment;
 - Equipment to be used for hot work;
- Complete a field level hazard assessment (FLHA) prior to commencing work focusing on:
 - The work area;
 - Areas adjacent to the work area that may be affected by the hot work;
 - Elimination or control of hazards as required; and
 - Ensure that all affected workers participate in FLHA.
- Confirm that isolation measures and controls determined by the safe work permit and or field level hazard assessment have been implemented; and
- Verify that adjacent sewer manholes have been covered with fire blanket or as appropriate.

3.2.2 ENSURE THE SAFETY OF THE WORKERS IN THE AREA

- Be familiar with the facility and the site specific emergency response plan;
- Identify the specific PPE requirements;
- Ensure any equipment identified as defective is reported to the appropriate Contractor Supervisor for replacement and repair; and
- Ensure appropriate warning signs and barricades are in place.

3.2.3 SAFELY SUPPRESS AND/OR EXTINGUISH THE FIRE

- Recognize areas or conditions that may be affected by the hot work and be alert for changing conditions, developing hazards or signs of fire;
- Correct or stop any conditions that may lead to fire and report them to the appropriate personnel;
- Know how to use fire extinguisher equipment, where it is located and ensure it is operational prior to an event;

- Understand how to notify additional support (i.e. Operations, supervisor) if required; and
- Inform appropriate personnel after extinguisher discharge so it can be recharged by qualified personnel and placed back into service.

3.2.4 ADDITIONAL RESPONSIBILITIES

A fire watch is required when engaged in certain hot work activities, including but not limited to:

- Welding, flame cutting, arc-air gouging or grinding in hazardous areas or restricted areas;
- Any hot work on or around open systems; and
- Any hot work where the potential for ignitable material may be present.

The role of the fire watch is to protect workers by monitoring for fire hazards during a work activity. A qualified worker shall be assigned the fire watch role and instructed based on the scope of work. The fire watch shall not be assigned or perform other duties.

If the fire watch leaves the work area the work activity shall stop, unless there is another qualified worker who can assume the fire watch duties.

The fire watch shall have the ability to clearly communicate to the workers under their care and access emergency response and site supervision as required.

One or more fire watch may be required when hot work is being conducted, based on the hazard assessment.

If hot work is being conducted in a hazardous or restricted area, then a fire watch is required and shall be maintained for at least one half hour after the work is completed.

A fire watch is also required when hot work is being executed in an unclassified area where combustible or flammable materials are present and could become a potential ignition hazard.

In addition, when hot work is conducted within 15 m (45 ft.) of an area with flammable or combustible contents, the fire watch shall check the area four hours after the work is completed, and document the results, unless:

- All flammable and combustible materials within 15 m. (45 ft.) are removed from the hot work area, or lined with non-combustible materials; and
- An approved engineering weld procedure is used when conducting hot work activities on pipelines and tanks containing product.

The person(s) planning and supervising the work shall assign a fire watch.

3.3 IGNITION SOURCES

Ignition sources have the potential to cause fires and/or explosions in areas where flammable vapors/gases are potentially present in the air. Ignition sources are typically created during hot work activities. Ignition sources include:

- Sparks (e.g., from electrical tools and equipment; welding, cutting and grinding; static electricity, abrasive blasting);
- Use of lighters, matches, cigarettes;
- Open flames (e.g., portable torches and heating units);
- Surfaces with enough heat to vaporize a combustible material (e.g., catalytic converter of an automobile in dry grass);
- Combustion engines or sources (e.g. vehicles/equipment, generators, compressors, mowers); and
- Vehicles and equipment left unattended in a restricted or hazardous area shall be shut off and not restarted until atmospheric monitoring confirms the absence of hazardous vapors.

The following precautions shall be made to eliminate or minimize ignition sources:

- Do not stop vehicles or equipment in areas where there is combustible ground cover like dry grass, weeds or straw;
- Leave strike-anywhere matches and lighters with open mechanisms, including disposable lighters in designated areas (e.g., left inside a vehicle or locker);
- Do not position portable light plants and/or generator sets near combustible or flammable material; and
- Do not drill metals without sufficient lubrication.
- Furthermore, when in hazardous and restricted areas:
 - Test for oxygen levels and flammable atmospheres prior to introducing ignition sources and continuously monitor these areas while ignition sources are present;
 - If a flammable atmosphere is present, use only explosion-proof electrical installations and explosion-proof electrical equipment;
 - Use only intrinsically safe electronic devices unless the air is initially tested and continuously monitored for flammable vapors and the equipment is listed on the SWP;
 - Shutdown vehicles and equipment whenever possible or when left unattended (do not restart the vehicle or equipment until atmospheric monitoring confirms the absence of a flammable atmosphere);
 - Use non-sparking tools that are kept clean and free from ferrous or other contaminants which may hamper non-sparking properties;

- Control all potential ignition sources;
- Ground and bond as required

When mechanically cutting pipe, ensure that the appropriate speed is used with sufficient lubrication to reduce potential for excessive heat production. Inspect and maintain equipment regularly (e.g. Friction in a defective or under-lubricated equipment bearing can overheat the bearing and cause a fire by vaporizing and igniting lubricating oil).

Workers shall review and observe the safe work permit including all atmospheric monitoring and sampling requirements prior to commencing work in a hazardous or restricted area.

3.3.1 DIESEL-POWERED EQUIPMENT - SPARK ARRESTORS

When operating diesel-powered equipment (excluding turbocharged equipment), sparks and cinders can be emitted through the exhaust of the equipment as a result of incomplete combustion within the engine. These sparks and cinders have the potential to ignite vapors that may be present within hazardous and restricted areas. In order to control this hazard, the exhaust system of diesel-powered equipment (excluding turbocharged equipment) must be fitted with a functional spark arrestor.

To remain effective, spark arrestors shall be periodically blown clean with compressed air through the cleanout plug.

3.3.2 DIESEL-POWERED EQUIPMENT – POSITIVE AIR SHUT-OFF DEVICES - USA

When operating diesel-powered equipment in hazardous and restricted areas, there is a potential for flammable vapors to enter the air intake of the engine of the equipment causing the equipment to continue running even when the ignition is turned off. The ongoing operation of this equipment can create the risk of ignition of the flammable atmosphere external to the equipment or may cause the engine to rev beyond its limits and fail catastrophically. In order to control this hazard, the air intake system of diesel-powered equipment operating in hazardous and restricted areas must be fitted with a functional positive air shut-off with or without a rev limiter. If using a positive air shut off without a rev limiter, a competent person must be stationed with the equipment to conduct continuous atmospheric monitoring and engage the manual shutoff switch.

For the purposes of satisfying the positive air shut off requirement above, hazardous and restricted areas are defined as written in API RP 500 for Class I Division 1 and Division 2, respectively.

3.3.3 DIESEL-POWERED EQUIPMENT – POSITIVE AIR SHUT-OFF DEVICES - CANADA

When operating diesel-powered equipment in hazardous and restricted areas, there is a potential for flammable vapors to enter the air intake of the engine of the equipment causing the equipment to continue running even when the ignition is turned off. The ongoing operation of this equipment can create the risk of ignition of the flammable atmosphere external to the equipment or may cause the engine to rev beyond its limits and fail catastrophically. In order to control this hazard, the air intake system of diesel-powered equipment operating in hazardous and restricted areas must be fitted with a functional positive air shut-off with or without a rev limiter. If using a positive air shut off without a rev limiter, a competent person must be stationed with the equipment to conduct continuous atmospheric monitoring and engage the manual shutoff switch. The hazard of use of diesel driven equipment in hazardous and restricted areas and the use of positive air shut-off for control of the hazard should be documented on the hazard assessment for the work.

For the purposes of satisfying the positive air shut off requirement above, hazardous and restricted areas are defined as written in API RP 500 for Class I Division 1 and Division 2, respectively.

To ensure the functionality of positive air shut off devices, a maintenance and inspection program shall be established which includes provisions for periodic functional testing of the device. Maintenance and inspection records must be kept and include the results of periodic functional tests performed. These records will be provided to the Company upon request.

Further to the requirements for functional testing during routine maintenance and inspections, a functional test should be conducted prior to use of diesel powered equipment in areas where vapors are known or suspected to be present (eg. open systems, leak sites etc.). The need for pre-use functional testing should be identified as an additional control on the hazard assessment. Where using this equipment in such an area for more than one day, the need to complete additional functional tests (eg. daily, weekly, etc.) should be further assessed based on the service and environmental conditions the equipment is exposed to.

Diesel-powered equipment fitted with positive air shut-off devices used in hazardous and restricted areas will be subject to spot checks on site. Spot checks may include the need to complete a functional test upon request by the Company. Spot checks may be completed as part of facility inspections, focused work practice inspections and/or safety observations. The spot checks and results of any associated functional tests completed will be recorded on the applicable documentation established for the assessment tool being utilized.

3.3.4 PYROPHORIC IRON SULFIDE

Pyrophoric iron sulfide is a black deposit that can build up in locations such as storage tanks, seal pots, piping and metal sumps. It develops when sulfur comes in contact with iron. When the deposit dries, it can ignite spontaneously. Precautions include:

- Identify equipment where iron sulfide is suspected;
- Tanks and vessels shall be purged of hydrocarbon vapors before opening;

- When iron sulfide is suspected to be present, provisions shall be made to keep the inner surfaces of opened equipment wet; and
- Disposal of accumulated iron sulfide shall be handled quickly and carefully to avoid creating a hazard.

Pyrophoric iron sulfide deposits may develop in tanks where sour crude oil or refined products have been stored. These deposits can ignite spontaneously when they dry out. Use water spray to soak iron sulfide at least once every 24 hours, or more frequently if considered necessary by Operations management.

In cone roof tanks, iron sulfide deposits may develop above the normal level of oil in the tank, or in the sludge at the bottom of the tanks (through scale from the roof having flaked off). Iron sulfide in the sludge at the bottom of the tank is not a spontaneous ignition hazard in the tank, but it will ignite spontaneously if allowed to dry out in the sun.

On tanks with pantograph seals, iron sulfide deposits may develop in the vapor space between the sealing ring and the shell of the tank. Spray water into the vapor space at least once every 24 hours, or as often as necessary to keep this space damp.

3.4 BONDING & GROUNDING

Electric charges can build up on an object or liquid when certain liquids (e.g., petroleum solvents, fuels) move in contact with other materials. This can occur when liquids are poured, pumped, agitated, stirred or flow through pipes. This buildup of electrical charge is called static electricity. Static electricity can potentially discharge which can lead to an explosion when sufficient amounts of flammable or combustible substances are located nearby.

To prevent the buildup of static electricity, it is important to bond or ground exposed metal. Bonding is done by making an electrical connection from one metal container to the other. Grounding is done by connecting the container to an already grounded object that will conduct electricity. This ensures that there will be no difference in electrical potential between the two containers and, therefore, no sparks will be formed.

Bonding and/or grounding shall be completed as required, including, but not limited to the following tasks:

- Cutting and separating a pipeline;
- Separating flanges;
- Loading or off-loading at sump tank locations;
- Dispensing flammable liquids from bulk drums into a secondary container;
- Removing an accessory attachment from a fixed Facility (e.g., a mixer from a tank);
- Using abrasive blasting equipment to clean tanks;
- Hydrovacing;

- Spray painting; and
- When using compressors, pumps and generators.

Bonding and/or grounding may be required for the following tasks:

- Drawing samples from the pipeline; and
- Draining oil from the pipeline into a pan.

In some cases, such as where piping forms an electrical bond, it may not be necessary to install bonding cables. Bonding cables shall meet Company requirements set out in this specification, industry standards and applicable legislation.

Where cathodic protection (CP) rectifiers are thought to be an ignition source near hot work activities, consult with the Company regional CP representative before deactivation of a CP system.

Prior to use and during use, all portable equipment used in bonding and grounding work (e.g., welding units, generators, portable light plants, air compressors, etc.) shall be properly grounded, in accordance with manufacturers' specifications and worksite requirements.

Workers shall:

- Wear appropriate hand protection when there is potential exposure to induced high voltage, including when handling pipe, valves, casing or measuring;
- Avoid breaking, cutting or detaching bonding cables once they are in place, for as long as a fire hazard exists;
- Ground or electrically bond containers to each other when transferring liquids;
- Only fill portable fuel containers when they are on the ground (never do so in truck beds, on tailgates or in the trunks of vehicles);
- Immediately contact Contractor Supervisor if there are any concerns about induced high voltage and work equipment;
- Ensure each bonding or grounding point is clean and free of paint, with a positive connection;
- Never use chains for bonding or grounding purposes; and
- Perform visual inspection of the cables and connection as required to ensure positive connection is maintained.

Please reference the *Ground Disturbance Specification* prior to executing bonding and/or grounding activities.

3.4.1 BONDING CABLES

When drawing oil or product samples from the line, or when loading or off-loading at sump tank locations use an uncovered braided copper wire with an alligator clip brazed/clamped to each end (or use other suitable bonding cable).

- Each pipeline crew shall have at least 2 prefabricated bonding cables made of minimum 10 gauge stranded copper wire with a spade connector brazed/clamped on each end and at least 2 grounding clamps for attaching the bonding cable to the pipe.
- Attach one end of the bonding cable to a ground consisting of a copper ground rod.
- Type and depth of copper rod to be used shall be based on job planning requirements.

3.5 INDUCED VOLTAGE

Where the pipeline follows a power line ROW, a hazard may exist if the pipeline lies within the electrical field generated by overhead transmission lines. The pipe can carry a hazardous AC voltage, known as induced voltage, which occurs as a result of stray electromagnetic field from the power lines. This hazard can also apply to pipe set up near high voltage sources on cribbing for welding.

- The voltage level depends on the current in the transmission lines, the geometric configuration of the pipeline with respect to the transmission lines, and the length of pipeline paralleling the transmission line;
- Induced voltage caused by proximity to overhead transmission lines may continue to affect pipelines, even when the pipeline no longer parallels the transmission cables. Induced voltage can be a hazard for up to 16 km (10 mi) beyond the point of departure
- Once a below grade facility is exposed, it shall be checked for induced voltage prior to commencing work on the facility. The facility shall be continually checked for induced voltage as required or monitored based on the hazard assessment;
- The industry-accepted safe limit for induced voltage limit on pipelines, appurtenances and other below grade facilities is 15V. Therefore, bonding and grounding is required to bleed off any charge in excess of 15V;
- If further aid is required to reduce the induced voltage to below 15V, contact Company Operations Engineering to determine the need to install a grounding grid for bonding and grounding below grade facilities, vehicles and equipment. If a grounding grid is installed, before starting work, ensure induced voltages on the bonded pipe, vehicles and equipment have been reduced to an acceptable level;
- Potential induction sites/areas (T-lines) shall be tested by a qualified worker;
- Only qualified workers are to mitigate induced voltage hazards; and
- When the potential for induced voltage exists, a hazard assessment shall be completed and reviewed with the involvement of the workers doing the work.

Contractors shall develop a safe work plan for controlling induced voltage. This plan shall include, but is not limited to, the following:

- Specialized PPE;
- Measuring/testing;

- Work stoppage for adverse weather conditions; and
- Grounding requirements for planned work.

For more information on installing bonding cables in specific scenarios see Appendix Table 1

3.6 CUTTING AND WELDING

When welding and cutting precautions shall be taken against exposure to:

- Excessive ultraviolet radiation;
- Burns;
- Fire and/or explosion;
- Asphyxiation;
- Exposure to toxic gases; and
- Fumes or dusts.

If welding or cutting cannot be conducted safely, then it shall not be performed until safe to do so following a hazard assessment. Remove flammable materials and products from the immediate vicinity when cutting or welding.

Where required, use partitions to enclose welding and cutting activities. Before work begins, the welder, or welder's helper, shall ensure that no other worker is at risk of exposure to the arc flash, cutting slag or the spark path. Ensure non-essential workers are removed from the hot work area and are restricted from gaining unauthorized access.

Turn welding machines off at the end of each workday or when left unattended.

The ground return line from the work being welded shall:

- Be a single cable rated for the load of the welding machine;
- Be in good condition; and
- Only be clamped to the material being welded.

3.7 CAMERAS AND COMMUNICATION EQUIPMENT

Cameras, audio-visual and communications equipment are only allowed on Company worksites with the permission of Company regional operations and project management. No pictures shall be taken without the approval of Company regional or project management.

In hazardous and restricted areas, a safe work permit is required.

3.8 SMOKING AND FIREARMS

Smoking, including electronic cigarettes, is only allowed outdoors in marked, designated areas; a proper waste container shall be provided, along with a 20 lb. ABC fire extinguisher

Unless prohibited by applicable legislation (e.g., vehicles, busses, labs, offices etc.), smoking is permitted on the right of way (ROW) providing that the ROW is stripped of vegetation and the work activity is outdoors on exposed mineral soil. The ROW shall be kept free of discarded cigarette butts by providing an adequate number of waste containers and 20 lb. ABC fire extinguishers shall be readily available. Smoking outside of unmarked areas on the ROW is prohibited.

Firearms, weapons, archery equipment and pets are prohibited on all Company locations.

4.0 REFERENCES

Occupational Safety and Health Administration (OSHA)

- Flammable and combustible liquids, 1910.106
- Fire Prevention Plans, 1910.39
- Portable Fire Extinguishers, 1910.157

Canada Labour Code, Part II; Canadian Occupational Safety & Health (COSH) regulations

- Hazardous Substances, 10.1
- Safe Occupancy of a Work Place, 17.1

5.0 APPENDIX

5.1 TABLE 1 INSTALLING BONDING CABLES

Task	Bond From	Bond To	Notes
Abrasive Blasting Equipment for Tank Cleaning	1. Blasting Hose Nozzle	1. Tank Shell or Tank Roof	
Cutting, Installing and Separating of a Pipeline	1. Grounding Clamp on one side of separation 2. Second cable from grounding clamp on one side of separation	1. Grounding Clamp on other side of separation 2. Grounding clamp on pipe section to be removed or installed	Ensure clamps make contact with clean, bare metal. First cable shall be long enough to span the work area. Second cable shall be long enough to clear the hazardous area when removing or installing pipe section.
Drawing Samples from Pipeline	1. Attach alligator clip on one end of Bonding cable (unbraided copper) to sample point on pipeline (i.e., pipe, valve)	1. Other end of Bonding cable to alligator clip on metal sample container	
Draining Oil From Pipeline to Pan	1. Pipeline	1. Metal Drain Tray	For plastic drain trays, second end of Bonding cable shall remain in contact with liquid being drained into tray at all times.
Loading or Off-loading at Sump Tank Locations	1. Object being loaded/off-loaded	1. Sump tank or piping connection at loading/off-loading Facility	For fiberglass sump tanks, attach second end to specified bonding point.
Dispensing from Bulk Drums to Secondary Container	1. Bulk Drum	2. Secondary Container	One container shall be grounded, and the other container bonded to the grounded container.
Removing accessory attachments from fixed facilities	1. Clean, bare metal on accessory attachment	1. Fixed Facility	Bonding cable shall be long enough to clear the hazardous area when removing attachments or span of work area when separating flanges.
	1. Flange	1. Flange	
Hydrovacating Near Underground Electrical Wires	1. Wand/Gun 2. Dig Tube 3. Mat # 1 4. Mat #1	1. Grounding Mat # 1 2. Grounding Mat # 2 3. Mat # 2 4. Hydrovac Truck	For distances greater than (>) 2m (6 ft.) from the Hydrovac truck, it may not be necessary to bond the mat to the truck (Step 4).

Note: Some tasks require more than one Bonding cable. The numbers listed in this table represent steps to be taken for proper Bonding (i.e., bond 1 to 1, and 2 to 2, etc.).

<End of Document>

Uncontrolled Copy if Printed or Downloaded



Contractor Safety Specification

Hydrostatic and Pneumatic Testing

Table of Contents

1.0	Definitions & Acronyms	3
2.0	Contractor Responsibilities	3
3.0	Specification Requirements	3
3.1	Hydrostatic Testing	4
3.2	15m (50ft.) Zone (Exclusion Zone).....	4
3.3	30m (100ft.) Zone.....	5
3.4	Pneumatic Testing	5
4.0	References.....	5

1.0 DEFINITIONS & ACRONYMS

Enbridge- Enbridge, Inc. and Enbridge (U.S.) Inc., hereinafter will be referred to as “Company”.

ROW—Right of Way

2.0 CONTRACTOR RESPONSIBILITIES

Contractor site supervisors shall:

- Ensure that workers under their control are aware of and comply with this specification; and
- Confirm that all requirements of the safe work permit and field level hazard assessment (FLHA) are being followed.

3.0 SPECIFICATION REQUIREMENTS

Where necessary, permits shall be obtained by the Company or the contractor as specified in the contract between the Company and the contractor. Copies of all permits (i.e. local, state, federal or provincial) shall be in the possession of the contractor site supervisor as well as the Company site inspector.

For worksite(s) where a section of piping is being tested, a Company representative shall be on-site.

At the testing location there shall be:

- A safe means of access and egress for trenches and properly installed scaffolding;
- Adequate lighting when night work is necessary and a fire extinguisher at both ends of a test section; and
- Adequate heating and lighting facilities for test workers located a minimum of 15m (50ft.) away from any testing facilities.

Other requirements include:

- Ensuring that only the workers directly involved in the testing are in the immediate vicinity of test heads, pressure pumps or exposed piping during testing;
- Preventing them from moving or violently separating, ensure temporary piping or hoses used during pressuring and depressurizing activities are anchored or secured by such method(s) as whip check connections, steel braid line wrap, or staking to the ground;
- Ensuring the use of appropriate hoses, piping, fittings, valves, etc., and that such equipment has an adequate pressure rating for the service; inspect the equipment before use, to ensure it is in good condition;

- Ensuring persons not directly involved in the testing shall be kept back a minimum of 30m (100ft.) from the pipeline, by the use of signs, fencing, and verbal warnings;
- Verifying pressure on both sides of check valves when hydro testing and depressurizing; and
- Providing a safe means to release pressure from both ends of the piping section; pressure shall be released prior to loosening or removal of fittings.

3.1 HYDROSTATIC TESTING

Two zones shall be established around any hydro test; a 15m (50ft.) exclusion zone and a 30m (100ft.) zone. These requirements shall be followed during all hydro tests. Unique circumstances may require additional measures to ensure the safety of workers and the public.

For testing being conducted only on the ROW, expand the 15m (50ft.) zone requirements to the 30m (100ft.) zone dimensions.

If leaks are observed (through gauge drop or visual inspection) then the pressure must be reduced to zero pounds per square inch (PSI) prior to entering the exclusionary zone. No adjustments of any kind are to be performed on pressurized piping.

Fuel containers, propane tanks, and other fuel storage shall not be permitted within the 15m (50ft.) zone. Testing trailers shall be parked with the entrance facing away from the test area. The testing trailer door(s) shall remain closed during testing operations. If it is necessary to test indoors, the 15m (50ft.) exclusion zone shall encompass the entire room in which the test is completed.

3.2 15M (50FT.) ZONE (EXCLUSION ZONE)

Facilities for test personnel and equipment shall be outside the 30m (100ft.) exclusionary zone.

On Company property, signs shall be placed by the Contractor on the day of the test. These signs, which are to remain in place until after the piping system has been depressurized, shall read as follows:

**“DANGER – RESTRICTED ENTRY – HIGH PRESSURE TESTING AREA
AUTHORIZED PERSONNEL ONLY”**

All unnecessary equipment and workers shall stay out of this zone when the pipe is pressurized above normal operating pressures.

Ensure the 15m (50ft.) zone applies over the entire length of the pipeline, spools or fittings being tested. Note: Within populated areas, traffic control is required and shall be identified in the field level hazard assessment and as part of the safe work permit.

Workers shall stay in their vehicles if they are within this zone monitoring the pipeline during the hydro test, with the exception of checking for leaks or opening or closing valves.

Hydro test signs shall be placed on public access points and located at a point 15m (50ft.) from the pipeline.

3.3 30M (100FT.) ZONE

This zone will not be marked; the public and other Workers shall stay at least 30m (100ft.) away from the pipe.

This zone applies over the entire length of the pipeline section being tested.

The public shall be kept out, except when crossing the pipeline in vehicles.

In the event piping and equipment is present in the test area or within 30m (100ft.), of the pressurized components, the area shall be flagged and remain off limits to all Workers during the test.

When testing trailers or vehicles are parked implemented extra precautions as necessary (e.g., stage behind large equipment).

When testing in buildings, all points of entry are to be manned or blocked. All personnel working in the building must be appropriately notified.

3.4 PNEUMATIC TESTING

Distinct warning signs shall be posted during air pressure testing, such as "DANGER, AIR PRESSURE TESTING IN PROGRESS."

4.0 REFERENCES

Canada Labour Code, Part II:

- Canadian Occupational Health & Safety Regulations, Hazard Prevention Program; Part XIX

Occupational Safety and Health Administration (OSHA) Act

- Section 5, Duties

<End of Document>



Contractor Safety Specification

Incident Investigation

Table of Contents

1.0	Definitions & Acronyms.....	2
2.0	Contractor Responsibilities	2
3.0	Specification Requirements	2
3.1	Incident Investigation Timelines.....	2
3.2	Initial Notifications	3
3.3	Incident Owner.....	3
3.4	Scene Control	3
3.5	Witness Management	3
3.6	Data Collection	3
3.7	Analysis	4
3.8	Incident Investigation Report Requirements	4
3.9	Corrective and Preventive Actions (CAPAs).....	5
3.10	Incident Closeout Review	5
4.0	References	5

1.0 DEFINITIONS & ACRONYMS

CAPA – Corrective and Preventive Actions

Direct Cause – circumstances that directly lead to the occurrence of the incident.

Enbridge—Enbridge, Inc. and Enbridge (U.S.) Inc., hereinafter will be referred to as “Company”.

Event – an occurrence that is related to the incident.

Hazard – a condition potentially causing harm to a facility; personnel and contractors, the environment, or the organizational culture.

Incident – an unplanned occurrence that results or could result in a significant adverse effect on property, the environment, or the safety of a person (this includes near misses).

Incident Close Out Review – a review inclusive of the Incident Owner to ensure that all incident information has been collected and documented and all action items have been actioned, verified and closed out.

Root Cause – the underlying reasons behind the direct cause that explain why the circumstances existed.

2.0 CONTRACTOR RESPONSIBILITIES

Contractors shall:

- Assume the role of Incident Owner;
- Ensure the scene is secure after an incident occurs;
- Ensure all incidents are reported to the Company;
- Provide appropriate resources to ensure Corrective and Preventive Actions (CAPA) are identified and resolved in a timely manner;
- Investigate all incidents; and
- Participate in an incident close out review process as required by the Company.

3.0 SPECIFICATION REQUIREMENTS

3.1 Incident Investigation Timelines

An initial written report shall be completed and provided to Company by the Contractor within 48 hours of an Incident.

A detailed final report shall be submitted within 7 calendar days of the Incident unless additional investigation time is necessary. If so, a request for more time shall be made to the specified Company Representative.

3.2 Initial Notifications

Incidents that occur when a Contractor is working for the Company shall be reported verbally immediately to the specified Company Representative.

3.3 Incident Owner

The Contractor is the Owner of Contractor and Subcontractor related incidents.

The Contractor shall assign individuals to complete the investigation and authorize the resources necessary to conduct the investigation and any necessary follow-up. The size and makeup of the investigation team depend on the incidents complexity and severity.

3.4 Scene Control

The initial response to an incident may require steps to ensure that:

- The scene is secured and all incident data is preserved as appropriate, and
- Only authorized personnel have access to the scene and are permitted to collect incident evidence.

The scene of an incident should only be disturbed to attend to the injured person(s), to prevent further injuries, prevent damage to the environment, or to protect property. Investigators should be knowledgeable regarding scene preservation requirements in accordance with the authority having jurisdiction.

Regulatory requirements could determine that the scene shall be secured until the authority(s) having jurisdiction take control over (and then releases) the scene.

When the scene of the incident is at the location not under Company control, the Contractor shall coordinate the investigation with the scene authority.

The Company reserves the right to determine when the incident scene can be released.

3.5 Witness Management

Management of witnesses should include:

- Limit interaction between witnesses to ensure independent data is gathered;
- Provide a safe location for witnesses;
- Make provisions for confidential interviews; and
- Address logistical factors such as shift change when scheduling witness interviews.

The witnesses should also write a statement of what they were doing, saw and heard at the time of the incident occurring as soon as possible after the incident.

3.6 Data Collection

The investigation team will gather data.

- The data gathered must be identified, labeled, documented and kept secure,
- The types of evidence that is to be collected fall into four general areas (Four Ps):
 - Position evidence – photographs, sketches, valve positions, the volume of product,
 - Parts evidence – equipment, materials, parts, liquids, etc.,
 - People evidence – witness statements, interviews, etc.,
 - Paper evidence – records, standards, procedures, etc.

Contributing factors such as work environment, equipment, work practices, supervision, staff skills, education, and training should be considered.

3.7 Analysis

Incident investigation teams should use an appropriate root cause analysis technique (e.g., DNV Systematic Causal Analysis Techniques (SCAT), DNV Barrier Systematic Causal Analysis Techniques (BSCAT), 5 Why's, TapRoot) based on the type and severity of the incident.

3.8 Incident Investigation Report Requirements

The incident investigation report will include, at a minimum:

- Date and time of the incident;
- Date and time of investigation;
- Names and titles of the investigation team;
- Description of the incident;
- Names and titles of the personnel, directly and indirectly, involved including any witnesses (if applicable);
- Injured worker information; including nature of injury; body part and location;
- Immediate, basic, and root causes, e.g., substandard practices or conditions, work or environmental conditions, job or process-related factors, personal factors, etc.;
- Preventative actions taken and/or recommended measures to prevent recurrence (e.g., need for systems/controls, or changes to work processes or systems);
- Statements from injured Worker(s), witnesses, supervisor(s), or others as required;
- Photographs and drawings
- Police Report (if applicable)
- Follow-up actions taken by the Contractor
- Report to be signed and dated by authorized Contractor representative
- Type of incident as defined in the Company severity matrix (Health & Safety (People), Environmental, Operational);

- Facts determined during the investigation, including a chronology of events leading up to the incident, at the time of the event and immediately following; and
- Causal analysis methodology employed and the analysis results

The Investigation must determine both immediate and root cause(s) and provide recommendations in the form of CAPA.

3.9 Corrective and Preventive Actions (CAPAs)

CAPAs should address each cause that is identified in the incident report. CAPAs must be assigned to an individual, be measurable and have a completion date. The individual that is responsible for the CAPA should be involved in the creation of the CAPA and should agree to the timeline for completion.

3.10 Incident Closeout Review

After the event report has been completed, the Contractor shall be prepared to present a review of the report, the findings, and the CAPA's to the Company in a joint review meeting, as determined by the Company.

For incident Level, A3P3 or higher, the Contractor shall prepare and present a review of the report, the findings, and the CAPA's, to the Company at a formal management review meeting. The scope of the review will be determined by the Company.

4.0 REFERENCES

API 1173, Pipeline Safety Management System Requirements, latest edition

CSA Z662, Oil and Gas Pipeline Systems, latest edition

CSA Z1005-17 Incident Investigation

Canadian Occupational Health & Safety Regulations (Part 15.4)

Industry Publications and References

NEB SOR/99-294, *National Energy Board Onshore Pipeline Regulations*, latest edition

PHMSA CFR Title 49 Part 195, *Transportation of Hazardous Liquids by Pipeline*, latest edition

<End of Document>



Contractor Safety Specification

Industrial Hygiene

Table of Contents

1.0	Definitions & Acronyms.....	3
2.0	Contractor Responsibilities	3
3.0	Specification Requirements	4
3.1	Characteristics of Products Transported by Pipeline	4
3.1.1	Natural Gas Liquids (NGLs)	4
3.1.2	Diluent.....	5
3.2	Entering Buildings Containing Natural Gas Products or Equipment	5
3.3	Radiation & Radiography	6
3.3.1	Site Preparation / Work Control	6
3.3.2	Sealed Radioactive Sources	6
3.4	Asbestos Management Program.....	7
3.4.1	Determining the Presence of ACMs or PACMs.....	7
3.4.2	Respiratory Hazards.....	8
3.4.3	Prevention of H ₂ S Exposures	8
3.4.4	Prevention of Benzene Exposures	9
3.4.5	Prevention of Oxygen Deficiency	10
3.4.6	Nuisance Dusts	11
3.4.7	Cadmium and Lead	11
3.4.8	Welding Fumes	12
3.4.9	Crystalline Silica.....	12
3.5	Nitrogen (Pipeline Purging).....	12
3.5.1	Site Preparation / Work Controls.....	13
3.6	Hearing Conservation.....	13
4.0	References.....	14

1.0 DEFINITIONS & ACRONYMS

Enbridge – *Enbridge, Inc* and *Enbridge (U.S.) Inc.*, hereinafter will be referred to as “Company”.

Exposure Limit - Workplace standard below which is believed that nearly all normal and healthy Workers may be repeatedly exposed, day after day, for working lifetime without adverse health effects.

Fatigue - Weariness or exhaustion due to extended periods of physical and/or mental exertion or illness.

Immediately Dangerous to Life or Health (IDLH) Concentrations - An atmospheric concentration of any toxic, corrosive or asphyxiant substance that poses an immediate threat to life or would cause irreversible or delayed adverse health effects or would interfere with an individual's ability to escape from a dangerous/hazardous atmosphere.

Self-Contained Breathing Apparatus (SCBA) - A respirator that has a portable supply of breathing air and is independent of the ambient atmosphere. The breathing air source is designed to be carried by the user.

Short Term Exposure Limit (STEL) - A 15-minute Time Weighted Average (TWA) exposure limit that should not be exceeded at any time during a workday even if the overall 8-hour TWA is within limits, and it should not occur more than 4 times per day. There should be at least 1 hour between successive exposures.

Threshold Limit Value (TLV) - Occupational exposure limit set by the American Conference of Governmental Industrial Hygienists (ACGIH) under which it is believed that nearly all Workers may be repeatedly exposed, day after day, over a working lifetime, without adverse health effects.

Time Weighted Average (TWA) Exposure Limit - the average exposure a contaminant for an individual over a given working period determined by sampling at given times during the period. Unless otherwise mentioned, TWA is the concentration of contaminants measured over an 8-hour period.

Vapor - Gaseous form of substances that are normally in liquid or solid state; it can be changed to solid or liquid by increasing pressure, decreasing temperature, or both. Evaporation may create vapors.

2.0 CONTRACTOR RESPONSIBILITIES

Contractor responsible for work shall:

- Ensure known or potential hazards are identified and controlled to prevent worker exposure.

Workers shall:

- Participate in the identification of potential hazards and monitoring of implemented controls to prevent exposure.

3.0 SPECIFICATION REQUIREMENTS

3.1 CHARACTERISTICS OF PRODUCTS TRANSPORTED BY PIPELINE

Company pipeline system transports various non-refined, synthetic, semi-refined or refined hydrocarbon liquids and natural gas liquids.

All products transported by pipeline shall be considered toxic and flammable volatile hydrocarbon liquids. All of these liquids are under pressure when the system is operating.

Vapors and gases released by these liquids:

- may create breathing Hazards, as well as fire and explosion Hazards
- are heavier than air, and will accumulate in buildings, Confined Spaces, and low areas such as pits, Excavations, bermed areas and natural depressions in the ground

The primary breathing Hazards associated with the pipeline products being pumped include petroleum vapors, benzene vapors and H₂S gas.

H₂S at levels of 100 ppm (IDLH) or more may be present in crude oils and condensates classified as sweet or sour.

Workers are at greatest risk of being exposed to these types of vapors and gases when working around free or released product and Open Systems. The risk of exposure also exists when working in Hazardous Areas and Restricted Areas.

- Respiratory, fire and explosion Hazards have the potential to exist around spills and Open Systems until the area or system is free of liquid and determined to be isolated and gas-free
- Gas detection is required to verify a safe atmosphere. Appropriate RPE shall be worn, as specified in job-specific procedures, and as required based on the results of Atmospheric Monitoring.

3.1.1 NATURAL GAS LIQUIDS (NGLS)

NGLs contain propane, butane and condensates such as heptane, hexane and pentane.

NGLs are considered to be the most hazardous of the products transported by pipeline.

When released into the atmosphere, NGLs may look like a steam cloud close to the source. NGLs are extremely cold, with a boiling point of -42°C (-44°F).

NGL vapour may smell something like gasoline, and may have a narcotic and intoxicating effect which could lead to unconsciousness.

Since NGLs are extremely flammable, all ignition sources shall be eliminated.

3.1.2 DILUENT

Like most petroleum, diluent is flammable and contains volatile substances in varying percentages. The lighter hydrocarbons included in diluent are typically naphtha, benzene and pentane.

As with other pipeline liquids, keep ignition sources away from diluents

In the event of a release, use RPE as required.

3.2 ENTERING BUILDINGS CONTAINING NATURAL GAS PRODUCTS OR EQUIPMENT

Buildings containing natural gas are provided with fixed gas detection equipment that is equipped with an alarm. The alarm will be triggered at the following concentrations of natural gas:

- 20% of LEL – low level alarm (audible and visible)
- 40% of LEL – high level alarm (audible and visible); results in an emergency shutdown

If the alarm for a fixed gas detection system has been triggered, the Contractor shall immediately contact a Company Representative to determine accessibility to the building.

The minimum entry criteria for entering buildings containing natural gas products or equipment are:

- at <10% LEL, entry is allowed
- at 10-20% LEL, entry is allowed if:
 - only Cold Work is planned
 - Safety Watch is present at all times
- at >20% LEL, entry is allowed for inspecting or opening and closing valves to
- reduce gas levels provided:
 - a Safety Watch is present at all times monitoring atmospheric levels
 - a safety harness and lifeline are used and an Employee trained in their use is present and in control of the lifeline
 - self-contained breathing apparatus (SCBA) or a supplied-air respirator (SAR) with egress bottle is used

Conduct continuous Atmospheric Monitoring while approaching the work area to verify acceptable conditions. If concentrations are higher than prepared for, exit the area and reassess the situation.

3.3 RADIATION & RADIOGRAPHY

When required, a Contractor who is licensed and properly qualified to perform radiography and NDT testing will be contracted to provide these services.

In all instances where X-ray or gamma ray equipment is being used, the Contractor shall ensure the use, storage, handling, transportation, and disposal of radioactive substances is in compliance with all Applicable Legislation. All radiographic work completed by the Contractor shall be performed under the direction of a federally licensed Worker (radiographic technician) responsible for radiation safety.

3.3.1 SITE PREPARATION / WORK CONTROL

Before radiography work begins, ensure:

- Distinctive warning signs are posted – DANGER! RADIOACTIVE MATERIAL, and
- Barricades or rope are placed to prevent access to the designated work area (Radiation Area).

Workers (and their vehicles and equipment) not involved in the radiography work shall remain outside of the designated Radiation Area until the radiographic technician provides notification that testing is complete and it is safe to enter.

Additional radiography requirements include:

- Where required by Applicable Legislation, radiographic inspection vehicles shall have 360 degree rotating amber lights on the roof and be clearly visible; the rotating lights shall be operating when X-ray/Gamma ray equipment is in use;
- Equipment or storage containers holding radioactive material shall be labeled “DANGER! RADIOACTIVE MATERIAL” and locked when not in use; a nameplate shall also be affixed to the equipment/container showing the owner’s name, the maximum quantity, the type of radioactive material and a symbol (trefoil) indicating ionizing radiation;
- In an emergency or Facility evacuation, the radiographic technician shall ensure that the radioactive source is in a secure position, isolated and safe before leaving the work area.

Contractors performing this work are responsible for acquiring, transferring or disposing of any and all radioactive material associated with this testing. When legally required to have a Radiation Safety Officer (RSO) present, the Contractor shall provide a qualified individual.

3.3.2 SEALED RADIOACTIVE SOURCES

Acquisition of radioactive materials for installation on Company operating assets shall be made in accordance with the existing specific licenses and coordinated through the Company RSO. Any new source material and source holders shall be added to the license through an amendment,

and prior to purchase. All shipments of such material shall be completed in accordance with the current license including the issuance of transfer documents for shipping and the receipt of the material.

Radiation sources for installation or removal shall only be handled only by an individual who is licensed and qualified to handle the specific source and holder in question.

At the time of installation, a radiation survey shall be performed by the installer to ensure that the source and holder are operating properly and radiation levels around the source are within expected background levels.

3.4 ASBESTOS MANAGEMENT PROGRAM

Contractor in conjunction with Company shall determine if work in an area will disturb, or has the potential to disturb, confirmed or presumed Asbestos-Containing Materials (ACM).

Procedures for removing asbestos are largely similar, but with some slight differences in each jurisdiction (e.g. country, province, state, or local municipality). Contact Company Health & Safety personnel 30 days in advance of asbestos remediation projects, and obtain clarification or verification of applicable procedures or updates/changes to the procedures.

Completion of Asbestos Awareness training is required for all Workers who could potentially be exposed to Asbestos Containing Material (ACM). Contractors shall evaluate the awareness training requirement based on work type. Ensure all workers and supervisors performing asbestos abatement are trained per regulatory requirements.

All products with asbestos fibers and all containers of asbestos shall be labeled as follows:

- Danger: contains asbestos fibers. Avoid creating dust. Cancer and lung disease hazard.

Asbestos fibers inhaled into the lungs can lead to lung cancer, asbestosis or mesothelioma.

If a Worker's exposure to asbestos is verified as beyond the 8-hour TWA limit of 0.1 f/cc and/or the 30-min excursion limit of 1 f/cc and/or the 30-min excursion limit of 1 f/cc, then Medical Surveillance of that Worker by the Contractor shall be required.

3.4.1 DETERMINING THE PRESENCE OF ACMs OR PACMS

The following are common examples of ACMs that are known to contain asbestos or presumed (PACM) to contain asbestos:

- Insulation on abandoned waste heat boilers and piping,
- Plain and perforated asbestos board panels on interior walls and ceilings, e.g., in some Station buildings,
- Insulation on standby generator exhaust piping,
- Some floor tiles,

- Gasket material on pumping units,
- Flanges on piping,
- Some pipe coating, e.g., coal tar wrap,
- Underground concrete electrical duct banks at Terminal Sites,
- Vermiculite insulation,
- Electrical switchgear.

To determine the location of ACMs, review the Asbestos Inventory. Contact the Company Corporate Health & Safety Department or an Company Representative for the Asbestos Inventory.

Bulk samples for laboratory asbestos analysis shall be taken by a Qualified Worker.

Samples shall be collected in accordance with the approved procedures.

3.4.2 RESPIRATORY HAZARDS

At Company Locations where there is the potential for Workers to be exposed to the respiratory Hazards detailed in this section, the following shall occur:

- Implement engineering Controls and work practices to reduce employee exposure to below the Exposure Limit
- Develop a Hazard Assessment and ensure a Control plan is completed
- Have provisions for site-specific contingency/emergency plan
- Ensure personal exposure monitoring is performed where required
- Make detection and monitoring equipment available for personal and Area Monitoring
- Before work begins, inform Workers of any potential exposures at the Site or Facility
- Communicate the results of exposure monitoring to all affected Workers
- Ensure initial and periodic Atmospheric Monitoring is completed where required
- Beyond the basic PPE, Contractor shall also make available any additional PPE or RPE that may be required for a given Hazard

For additional information, see the Atmospheric Monitoring, Personal Protective Equipment and Respiratory Protection Specifications.

3.4.3 PREVENTION OF H₂S EXPOSURES

Hydrogen Sulfide (H₂S) enters the body through inhalation. It is:

- A toxic, colorless gas which has the odor of rotten eggs at low concentrations
- Soluble in water

- Highly flammable
- Heavier than air

Health effects of exposure to H₂S can include:

- At low concentrations – headache, nausea, fatigue, dizziness, shortness of breath, cough; skin, eye and throat irritation; and/or loss of sense of smell
- At high concentrations – shock, convulsions, inability to breathe, unconsciousness or death

H₂S may be present in various work locations or circumstances, such as:

- Open systems
- When present as a free or released product
- In a sump or tank, especially when open to atmosphere (e.g., H₂S may release into the air when the contents in the sump or tank bottoms is stirred)

H₂S has poor warning properties. Olfactory (sense of smell) fatigue can occur with prolonged exposure to low concentrations (less than 100 ppm) or acutely at high concentrations (greater than 100 ppm).

3.4.4 PREVENTION OF BENZENE EXPOSURES

Benzene is a type of hydrocarbon that may be present in a variety of crude oil and chemical products. Benzene is:

- Extremely toxic, with carcinogenic properties; it can enter the body through inhalation, ingestion and skin absorption
- A clear, colorless liquid with a pleasant, sweet odor; the odor, however, does not provide adequate warning of its presence as a hazard
- Highly flammable, with a low flash point
- As a vapor is heavier than air, and can form explosive mixtures
- As a liquid is not soluble in water and will float (as it is lighter than water)

Health effects of exposure to benzene can include:

- Moderate to severe irritation to the skin, and eyes, and mucous membranes
- Aspiration

Short-term exposure to high concentrations of benzene may lead to gastrointestinal and neurological toxicity.

Long-term exposures of benzene, even at low concentrations, may lead to blood disorders such as anemia or leukemia and other cancers.

The 8-hour Threshold Limit Value (TLV) for benzene is 0.5ppm, and the Short-Term Exposure Limit (STEL) for benzene is 2.5ppm.

Benzene exposure may be found in the following locations and situations:

- Gasoline and petroleum pipelines
- Pipeline valve assemblies
- Tank repair, maintenance and cleaning operations
- Field maintenance operations
- Bulk terminals and service station operations
- Any open system operations
- Lab operations
- Leak sites and free/released product

In addition to other appropriate Controls or measures, follow these Controls for benzene:

- Continuous or periodic Atmospheric Monitoring and monitoring of benzene shall be conducted tasks where a potential for benzene exposure occurs
- Signs shall be posted at entrances to any identified areas that contain benzene
- Chemicals containing benzene shall be secondarily contained and have proper signage to notify workers of potential exposure.
- Food and drink should not be stored or consumed in areas where benzene is, or may be present; always wash hands prior to eating, drinking or smoking to reduce possible ingestion
- Designated areas for use and storage of benzene shall be established

Where exposure to benzene above the Exposure Limit is known or suspected, appropriate work practices, engineering Controls and PPE requirements shall be implemented.

3.4.5 PREVENTION OF OXYGEN DEFICIENCY

Normal air contains approximately 21% oxygen and 79% nitrogen. Oxygen deficient atmospheres occur when the percentage of Oxygen drops below 19.5%.

Oxygen deficient atmospheres may occur in different circumstances or locations, such as:

- During purging operations
- When the use of CO₂ or halon fire extinguishing systems displaces oxygen (as part of putting out the fire)
- In enclosed spaces, e.g., where the presence of petroleum vapors can lead to an oxygen deficiency

In other cases, the presence of petroleum vapors is not the issue. For example, in a sealed, cleaned tank, some oxygen is used up as the interior walls of the tank rust, creating an oxygen deficient atmosphere.

Health effects of being exposed to an oxygen deficient atmosphere include:

- Deep and rapid breathing
- If the oxygen level goes as low as 16%, the effects progress to dizziness, rapid heartbeat, headache and a possible inability to move
- At 14% and lower, humans cannot survive

3.4.6 NUISANCE DUSTS

Nuisance dusts are a common workplace air contaminant. Dusts can become a respiratory Hazard to Workers when sufficient amounts of inhalable or respirable particulates are present in work space air.

Nuisance dusts can be generated by many commonly used work practices .. Work practices can include, but are not limited to:

- Abrasive blasting
- Cutting and grinding

TLVs for inhalable and respirable particulates are 3 milligram per cubic meter (mg/m^3) and 10 mg/m^3 , respectively.

Where Worker exposure to nuisance dusts above a TLV is known or suspected specific work practices and Control measure must be in place. This may include one or more of the following practices:

- Dilution ventilation
- General or local exhaust ventilation
- Respiratory Protection Equipment (RPE)
- Skin protective equipment or clothing
- Dust suppression or wetting

3.4.7 CADMIUM AND LEAD

Cadmium and lead are toxic metals commonly found in industrial paints and coatings. Because of their anti-rust and anti-fouling properties, cadmium and lead are often electroplated onto steel nuts, bolts, and rivets. Operations involving the removal of cadmium and lead paints may pose a significant exposure Hazard.

Prior to commencing operations that involve the disturbance of painted surfaces at Company facilities. determination of the presence or absence of lead and cadmium shall be conducted. If

the presence of cadmium or lead is detected in painted materials, work practices and exposure Control strategies shall be approved by Company representative. Sampling of materials shall only be performed by a Qualified Person in accordance with the process.

3.4.8 WELDING FUMES

Jobs involving welding activities are known for generating high levels of welding fumes (either general welding fumes or specific metal fumes), which may pose a health Hazard to the health of welders or other Workers in the vicinity of the job. A combination of respiratory protection and ventilation is required to Control Hazards associated with welding fumes. If conditions allow, air sampling for welding fumes shall be implemented, the main target of the sampling will be welding activities performed inside of Confined Spaces to determine exposures to the following:

- Total welding fumes
- Chromium
- Chromium VI
- Nickel
- Manganese

3.4.9 CRYSTALLINE SILICA

When Workers chip, cut, drill, or grind objects that contain crystalline silica (such as concrete cutting) it can become a respiratory Hazard.

Crystalline silica (refractory materials) is found in materials commonly used to insulate crude oil heaters including:

- Insulating Firebrick and Insulating Castable, which break down through the normal cycling of the heater and the turbulent flue gas, creating dusts that are disturbed on entry
- Kaowool Blanket Products, which may contain crystalline silica after being exposed to temperatures above 982°C (1800°F) (Such temperatures are not unusual during normal operation of the crude oil heaters)

Specific work practices and Control measure must be in place and approved by the Company representative when engaging in work that involves exposure to crystalline silica.

3.5 NITROGEN (PIPELINE PURGING)

Nitrogen is a colorless, odorless, relatively inert gas. Nitrogen is used to purge product from the pipeline in preparation for certain work activities.

Once the pipeline is purged, excess nitrogen is vented (i.e., the pipeline is depressurized) and residual nitrogen remains in the pipeline.

To reduce risks of exposure, consider the following factors and Hazards:

- Increasing the nitrogen concentration in air lowers the oxygen concentration. If the concentration of nitrogen is too high (and oxygen too low), a person will become oxygen deprived and simple asphyxiation occurs.
- Nitrogen is usually transported and stored in liquid form. Always use nitrogen in a well-ventilated area.
- The transition from liquid to gas can generate a lot of pressure quickly, which causes cold temperatures. Liquid nitrogen is extremely cold and can cause severe frostbite upon contact.
- Cold nitrogen gas is heavier than air, so the risk of exposure to nitrogen is greatest in low lying areas, e.g., Excavations, tank berms, vaults and culverts.

3.5.1 SITE PREPARATION / WORK CONTROLS

To reduce potential exposures to nitrogen, use Controls such as:

- Install a windssock, for monitoring wind direction
- Ensure SCBA (2 minimum) and fire extinguishers are readily available
- Always position liquid nitrogen trucks/tanks, injection equipment and lowdown tanks in well-ventilated areas (to prevent accumulation of excessive concentrations of nitrogen)
- Install piping or hoses to vents and locate discharge ends downwind away from work area; inform Workers to stay clear
- Signage shall be place by Contractor to communicate hazards associated with the purge process
- Ensure Workers wear hearing protection during nitrogen injection and venting activities
- Ensure Workers wear appropriate eye/face protection, RPE, insulated gloves and body protection as needed, when handling or operating purging equipment

Workers not directly involved in nitrogen purging activities shall stay upwind, out of the work area and in designated safe zones.

3.6 HEARING CONSERVATION

Workers who are exposed to noise at 85 dBA or above shall wear hearing protection. Contractors shall ensure appropriate hearing protection is provided and available to Workers at each Worksite, and that the protection is properly used and maintained in accordance with manufacturers' specifications.

Contractors shall have a hearing conservation program where required and are responsible for providing their workers with the required testing, training, and any required hearing protection.

Areas and fixed equipment with noise levels greater than (>) 82 dBA shall be identified and marked with posted signs.

Hearing protection shall be worn as follows:

- In work areas where hearing protection signage is posted, when equipment is operating,
- When operating any piece of equipment where the noise level is greater than (>) 85 dBA,
- When exposed to noise levels greater than or equal to (\geq) 105 dBA, Workers shall wear both ear plugs and ear muffs, and
- When an arc flash Hazard exists, Workers shall wear ear canal inserts (i.e., ear plugs).

4.0 REFERENCES

Canada Labour Code, Part II:

Canadian Occupational Safety & Health (COSH) regulations

Employee Exposure and Medical Records, 29 CFR 1910.20

National Fire Code, Part 5 (referenced by Canada Labour Code, Part II)

Occupational Safety and Health Administration (OSHA)

Transportation of Dangerous Goods (TDG) regulations

Workplace Hazardous Materials Information System (WHMIS) regulations

<END OF DOCUMENT>



Contractor Safety Specification

Personal Protective Equipment



Table of Contents

- 1.0 Definitions & Acronyms 3
- 2.0 Contractor Responsibilities 3
- 3.0 Specification Requirements 3
 - 3.1 Personal Protective Equipment 3
 - 3.1.1 Head Protection 3
 - 3.1.2 Eye Protection 4
 - 3.1.3 Hearing Protection 4
 - 3.1.4 Hand Protection 4
 - 3.1.5 Foot Protection 5
 - 3.1.6 High-Visibility Safety Apparel 5
 - 3.1.7 Worksite Clothing Requirements 6
- 4.0 Appendix 9
 - 4.1 Appendix A 9

1.0 DEFINITIONS & ACRONYMS

ANSI—American National Standards Institute

ASTM—American Standard for Testing and Materials *CSA*—Canadian Standards Association

Company worksite—Entire work area required for the work, including station property, right-of-way, temporary working space, and all right-of-way storage areas as required by Company. It does not include administrative offices, control rooms, lunch rooms or change rooms.

Enbridge—Enbridge, Inc. and Enbridge (U.S.) Inc., hereinafter will be referred to as “Company”.

FR—Flame Resistant

HVSA—High Visibility Safety Apparel *ICS*—Incident Command System

NFPA—National Fire Protection Agency

PPE—Personal Protective Equipment

2.0 CONTRACTOR RESPONSIBILITIES

Contractor Management:

- Provide workers with appropriate PPE;
- Ensure workers are trained on the use, maintenance, and limitations of the PPE;
- Confirm that workers are wearing the required and approved PPE;
- Ensure that the maintenance and inspection of PPE is completed
- Wear appropriate PPE when required

Workers shall:

- Use all required PPE;
- Maintain, store and inspect PPE in accordance with manufactures’ specifications, and
- Dispose of and replace any defective/damaged PPE

3.0 SPECIFICATION REQUIREMENTS

3.1 PERSONAL PROTECTIVE EQUIPMENT

Company has minimum requirements for PPE listed in this specification. Additional PPE or protective apparel may be required depending on the specific site requirements, hazards or work activities.

3.1.1 HEAD PROTECTION

At a minimum, *Class E* approved industrial head protection (hard hats) shall be worn at all times on Company worksites except when:

- Sheltered in a vehicle or equipment with an enclosed cab;
- Actively engaged in welding where overhead hazards have been eliminated;
- Getting in or out of helicopters or when working near helicopters under full throttle (unless the helicopter is involved in slinging operations); and/or
- Working in, on or near open water as determined by an incident commander when under the Incident Command System (ICS).

Workers shall:

- Only wear liners made for wearing under hard hats. Liners must be FR rated when working in areas requiring FR (see Section 3.1.7.3);
- Store hardhats away from heat sources;
- Not wear Cowboy style hardhats;
- Not apply products to the hardhat that may degrade or weaken the hard hat shell or component materials (e.g., do not apply insect repellent).

3.1.2 EYE PROTECTION

Company requires all workers to wear ANSI Z87.1 or CSA Z94.3 approved safety glasses (prescription and non-prescription) and impact resistant side shields at all times when working on Company worksites.

Safety glasses are not required in a vehicle or equipment with an enclosed cab.

3.1.3 HEARING PROTECTION

Workers who are exposed to noise at 85 dBA or above shall wear hearing protection. Hearing protection shall be worn as follows:

- When in work areas where hearing protection signage is posted;
- When operating or working around any piece of equipment where the noise level is greater than (>) 85 dBA;
- When exposed to noise levels greater than or equal to (\geq) 105 dBA, workers shall wear both ear plugs and ear muffs; and
- When an arc flash hazard exists and hearing protection is required, workers shall wear ear canal inserts (i.e., ear plugs).

3.1.4 HAND PROTECTION

Hand protection shall be worn at all times on Company worksites. Hand protection shall:

- Be appropriate to the task being performed;

Uncontrolled Copy if Printed or Downloaded

- Provide suitable hand protection against any known or foreseeable hazards related to the task; and
- Allow the wearer to effectively complete the task while using them.

If gloves cannot be worn because it creates an additional hazard within the execution of the task, it needs to be documented on the Field Level Hazard Assessment along with any additional mitigative actions taken to reduce the potential for a hand injury.

3.1.5 FOOT PROTECTION

CSA 1 or ASTM F2413-11 MI/75 C/75 approved protective footwear shall be worn at all times on Company worksites. Protective footwear shall have markings as required as shown in the Appendix A, Table 3, by jurisdiction.

Protective footwear shall:

- Have a minimum height of 15cm (6-in) ankle support, when measured from the heel to the top of the boot,
- Have slip-resistant sole, and
- Provide sufficient protection against injury to the feet and ankles as appropriate for the work environment and assessed Hazards.

Workers and visitors may be exempt from the requirement for protective footwear only if:

- They are on a supervised or controlled tour of a site or facility, or
- If they are visiting a site or facility for administrative reasons only, and while there, are not exposed to hazards that would require the foot protection set out in this specification.

3.1.6 HIGH-VISIBILITY SAFETY APPAREL

High-Visibility Safety Apparel (HVSA) shall be worn by Workers when required by a Hazard Assessment, Worksite requirements and/or regulatory requirements.

Company requires all workers to wear at a minimum ANSI 107 or CSA Z96 approved Class 2, high visibility safety apparel (HVSA) on Company worksites when:

- working as a designated Signaler/Spotter;
- working on or adjacent to roadways with traffic speeds under 80 km/hr. (50 mph);
- working around Powered Mobile Equipment;
- working on active construction sites;
- operating ATVs, UTVs and Snowmobiles;
- working in low light or inclement weather conditions; and

- Determined by the Hazard Assessment.

HVSA shall include high visibility headwear (i.e., reflective marking) to increase a worker's visibility in situations where part or all of the worker's body could be obscured, e.g., due to trees, traffic barriers, objects, vehicles or construction materials.

High visibility vests shall be FR rated for the following working environments:

- Inside fenced or operating facilities;
- Working within 30m (100ft.) of an open system;
- Working within 30m (100ft.) of Ground Disturbance/Excavation that contains an operating pipeline; and
- Any other work where there is the potential for flash fires or short duration flame exposures identified on the hazard assessment.

Class 3 HVSA shall be worn:

- When working on or next to roadways with traffic speeds above 80 km/hr. (50 mph),
- By traffic control personnel; and
- As determined by the hazard assessment.

3.1.7 WORKSITE CLOTHING REQUIREMENTS

3.1.7.1 General Clothing Requirements

Company requires all workers to wear full-length pants and long-sleeved shirts on worksites at all times.

On mainline construction, a minimum requirement of six inch sleeves is acceptable on green field sites or during new mainline construction unless the hazard assessment identifies the need for long sleeve shirts.

3.1.7.2 Life Jacket Requirements

Approved life jackets shall be worn when working within 3m (10ft.) of open water (where there is a possibility of drowning).

The type of life jacket used shall be based on the hazard assessment and United States Coast Guard or Transport Canada Requirements as applicable.

3.1.7.3 Flame Resistant (FR) Garment Requirements

Workers shall inspect, wear, maintain and store FR garments in accordance with the manufacturers' specifications (NFPA2112 and CAN/CGSB 155.20).

Workers shall wear FR garments for daily work when:

- Inside fenced or operating facilities,

- Within 30m (100ft.) of an open system,
- Within 30m (100ft.) of ground disturbance/excavation that contains an operating pipeline, and/or
- Within any area where exists a potential for flash fires or short duration flame exposures identified on the hazard assessment.

Exceptions to the FR Requirements are in low risk areas including:

- Areas on the ROW identified by the Company, and/or
- Controlled vehicle or escorted tours where risks are eliminated by a Company representative.

For this document, the outer layer for FR garments may consist of shirt, pants, coveralls or jacket.

The outer layer of FR garments provided by Contractor for Contractor worker shall be a minimum arc thermal protection value (ATPV) of 8 cal/cm² and arc flash PPE Category 2. Electrical workers may require an increased level of protection as required by the arc flash hazards label.

FR rainwear worn for protection to flash fires should be compliant to ASTM F2733 and shall state so on the interior label of the garment. FR rainwear worn for arc flash protection should be compliant to ASTM F1891 and shall state so on the interior label of the garment.

If FR garments do not provide sufficient protection from identified hazards, then additional PPE shall be determined (i.e., exposure to steam, longer heat transfer).

Workers shall wear clothing made with a natural fiber (e.g., cotton, wool) or approved FR undergarments below FR outerwear.

If other safety hazards or concerns (e.g., exposure to asbestos, corrosive materials) exceed the fire hazard, then non-flame-resistant outerwear may be worn over approved FR clothing.

- FR garments shall:
 - Be worn with collars closed and sleeves and cuffs worn down and secured;
 - Be kept reasonably free from hydrocarbon products like grease and oil;
 - Be cleaned frequently enough to prevent build-up of contaminants that reduce flame resistance;
 - Be worn as the outer garment and shall fully cover any non-FR garments worn when FR Garments are required;
 - Not have insect repellents containing DEET applied or sprayed directly on FR Garments as it will negatively impact the resistance of the garments;
 - Be stored in accordance with manufacturer instructions;
 - Be removed from service when damaged;

-
- Be inspected prior to use considering the following criteria:
 - Fabric damage;
 - Damage to threads or seams including skipped, broken or missing stitches;
 - Damage to and functionality of all hardware such as zippers, buttons, snaps and other fasteners.

4.0 APPENDIX

4.1 APPENDIX A

Table 1 ANSI/ISEA Z87.1 Minimum Eye Protection Marking Requirements

Spectacle Lenses	Other Lenses	Frame/ Temple/ Headgear
Shall have: <ul style="list-style-type: none"> ▪ Manufacturer's Mark or Logo ▪ "+" if Impact Rated 	Shall have: <ul style="list-style-type: none"> ▪ Manufacturer's Mark or Logo ▪ "Z87" ▪ "+" if Impact Rated 	Shall have: <ul style="list-style-type: none"> ▪ Manufacturer's Mark or Logo ▪ "Z87" Plano or "Z87-2" Rx ▪ "+" if Impact Rated

Table 2 CSA Z94.3 Minimum Eye Protection Marking Requirements

Lenses	Frame/ Temple/ Headgear
Shall have: <ul style="list-style-type: none"> ▪ Manufacturer's Mark or Logo 	Shall have: <ul style="list-style-type: none"> ▪ Manufacturer's Mark or Logo ▪ "CSA Z94.3"

Table 3 Protective Footwear Markings

	Canada	USA
General hazards	CSA 1 (Green Triangle)	ANSI Class 75
Electrical work or entering substations	Omega symbol (Ω)	Electrical Hazard (EH)
Chainsaw work	White label with green fir tree symbol	---

<End of Document>



Contractor Safety Specification

Powered Mobile Equipment

Table of Contents

1.0	Definitions & Acronyms.....	3
2.0	Contractor Responsibilities	3
3.0	Specification Requirements	4
3.1	Powered Mobile Equipment	4
3.1.1	Safe Operating Requirements for Powered Mobile Equipment.....	4
3.1.2	Elevated Work Platforms.....	6
3.1.3	Tracked Equipment	7
3.1.4	Excavation Equipment for Lifting.....	8
3.1.5	Side Booms	8
3.1.6	Boom/ Picker Trucks	9
3.1.7	Ditching Machines	9
3.1.8	Cranes.....	9
3.2	Equipment Inspection.....	11
3.3	Signalers and Spotters.....	12

1.0 DEFINITIONS & ACRONYMS

Enbridge—Enbridge, Inc. and Enbridge (U.S.) Inc., hereinafter will be referred to as “Company”.

EWP—Elevated Work Platform

Heavy Service—Service that involves operation of lifting equipment within the safe working load that exceeds normal service.

Normal Service—Involves operation of lifting equipment with randomly distributed load within the rated load limit or uniform load of less than (<) 65% of rated load limit for no more than 25% of the time for a normal work shift.

Powered Mobile Equipment—a self-propelled machine or combination of machines, including a prime mover designed to manipulate or move material.

PPE—Personal Protective Equipment

Qualified - one who, by possession of a recognized degree, certificate, or professional standing, or who by knowledge, training and experience, has successfully demonstrated their ability to solve or resolve problems relating to the subject matter, the work, or the project

ROPS—Roll Over Protection Structure

Swing Radius—the maximum reach of a boom/attachment and all contents (ex. Logs, boulders, construction materials), in all directions from the cab of the equipment. For example, an excavator with a 10m boom and bucket reach would have a swing radius of 10m in all directions from the cab, plus any additional allowance for materials being transported.

2.0 CONTRACTOR RESPONSIBILITIES

Operators shall:

- Complete training in the use of required safety equipment (e.g., warning devices, fire extinguishers, PPE, etc.);
- Operate equipment in safe operating condition;
- Operate only equipment for which they have the required specialized licenses or certificates (if applicable) or have obtained training and demonstrate competency to operate the equipment.
- Documentation must be made available upon request;
- Obey all traffic signals and posted speed limits;
- Operate only properly equipped and maintained equipment;
- Be responsible for the safe operation and movement of the equipment; and
- Ensure work area is set up appropriately for equipment operation.

Uncontrolled if Printed or Downloaded

Signallers/spotters shall:

- Know appropriate hand signals;
- Complete any specific training required by applicable legislation and/or as required by the company in charge of the lift;
- Wear appropriate PPE to distinguish themselves from other workers if applicable, Class 2 HVSA;
- Stop equipment when hazards are observed, and inform operators and workers of people entering the immediate work area; and
- Observe and communicate on the movement of the equipment.
- Contractor Management shall:
 - Ensure operators are competent on the equipment they are operating; and
 - Ensure work area is set up appropriately for equipment operation.

3.0 SPECIFICATION REQUIREMENTS

3.1 POWERED MOBILE EQUIPMENT

3.1.1 SAFE OPERATING REQUIREMENTS FOR POWERED MOBILE EQUIPMENT

Powered mobile equipment shall:

- Have seatbelts (exception for elevated work platforms (EWPs) and scissor lifts);
- Be equipped with engineered roll over protection structure (ROPS) (exception for EWPs and scissor lifts);
- Have manufacturer-installed horns that are functional;
- Have audible, functional back-up alarms;
- Have all required functional lighting;
- Have fire suppression equipment suitable for the equipment (as per manufacturers' guidelines);
- Have access/egress routes clear of obstructions;
- Shall be parked in an acceptable location that allows for access and egress with no added obstacles;
- Use wheel chocks when parked on an incline or there is a potential for unintentional movement (specific to Powered Mobile Equipment with wheels).
- Have appropriate placards on the unit as per regulatory requirements; and

- Have a log book readily available for all equipment used for lifts.

Workers operating powered mobile equipment shall:

- Wear seatbelts;
- Use agreed-upon horn signals;
- Complete pre-use inspection as per manufacturers' specifications;
- Ensure lighting is functional and used as necessary;
- Comply with all site traffic control plans;
- Wear Class 2 High Visibility Safety Apparel (HVSA) as a minimum whenever entering or exiting the cab of the equipment;
- Wear appropriate PPE as per hazard assessment when operating the equipment with an open door and/or window. If the cab of the equipment is not protected from the outdoor elements;
- Not use communication devices or allow other distractions during operation excluding 2-way radio communication when deemed necessary by hazard assessment;
- Not climb or allow others to climb powered mobile equipment while in motion;
- Not allow other workers to ride on powered mobile equipment, except in the seats provided (ensuring that all passengers wear seatbelts);
- Ensure keys are removed and equipment locked when daily work activities are completed;
- Use three points of contact whenever entering, exiting, or climbing ladders/designated points of access on equipment;
- Maintain adequate separation from all above and below grade facilities;
- Ensure mats are not stacked higher than the side boards on forwarders used to haul mats;
- Ensure cable guards, mesh/screen protectors, are installed before using a winch on tractors and other equipment;
- Adhere to the capacity ratings during operation;
- Make the unit inoperative and ensure it is in a safe state prior to exiting the equipment; and
- Use a signaler/spotter as required in the signaller/spotter section of this specification.

Swing Radius and Path of travel requirements:

- Ensure the appropriate swing radius is identified and all hazards within the area are noted and controlled;
- Ensure there is sufficient space when rotating the cab or when maneuvering through tight spots;
- Limit equipment use in congested work zones unless a clear work plan is established and communicated to affected workers;
- Additional spotters may be required in congested areas based on hazard assessment; and
- Workers walking with or guiding pipe, fittings, etc. are not standing in the fall zone. This includes but is not limited to moving pipe along the right of way, feeding bending machines, or handling piping around boring operations (track bores, cradle bores, etc.).

Positive Approach Confirmation Requirement

When approaching or passing equipment on foot or by vehicle (within 6 meters (20ft) of equipment or swing radius), the worker shall:

- Stop at least 6 meters (20ft) from equipment or swing radius and await positive acknowledgement from equipment operator via radio or visual contact;
- Confirm with the operator that it's safe to approach or pass the equipment; and
- Ensure that the attachment/implement (if applicable) is grounded before proceeding.

Operator shall confirm that worker/vehicle is out of operating radius plus the furthest material deposit radius before lifting attachments/implements and resuming work.

3.1.2 ELEVATED WORK PLATFORMS

Elevated work platforms (EWP's) with articulating boom and extended boom platforms shall be operated by qualified operators.

Operators shall document daily checks on each EWP before use.

EWPs shall:

- Have easily accessible upper (platform) and lower ground controls, with their functions clearly marked and tested each day prior to use;
- Lower controls that are capable of overriding the upper controls (lower controls shall only be operated in an emergency, unless the Worker in the lift has given permission);
- A qualified operator shall be readily available in the work area to operate lower controls in the event of an emergency;

- Only be used on a firm, level surface with the brakes set and outriggers positioned (if equipped) on pads or a solid surface; use wheel chocks when on an incline;
- Have the load rating posted (load rating shall not be exceeded);
- Have platforms that meet manufacturers' specifications and is designed and certified by a professional engineer;
- Have an anchor point specified by the manufacturer;
- Be inspected by a qualified person as required by manufacturers' specifications and applicable legislation;
- Have current inspection sticker visible and up to date; and
- Have owner's manual located on the work platform in a weatherproof container.

EWPs shall not:

- Be used for anything other than lifting Workers, tools and materials to an elevated Worksite;
- Be used as a crane or hoist; and
- Have loads placed or carried outside the platform perimeter or exceed the manufacturers' weight limit.

When in a EWP on mobile equipment, workers shall:

- Use a travel restraint system consisting of a full body harness and lanyard connected to an anchor point specified by the manufacturer;
- Have lanyards short enough to prevent the worker from being ejected from the work platform or elevated device but long enough to allow the worker to perform their work;
- Tie off to the attachment point at all times when elevated, including when entering, exiting or maneuvering;
- Climb in or out through a doorway;
- Maintain 100% tie off at all times;
- Not stand on rails or objects inside the platform; and
- Not tie off to an adjacent pole, structure, or equipment while working from the platform.

3.1.3 TRACKED EQUIPMENT

All tracked equipment shall be equipped with cleats or grouser bars to ensure maximum traction in frozen conditions. This also applies when mud or loose terrain is a concern and slippage is a potential risk based on a hazard assessment.

Traction aids may be applied after equipment is walked onto a site provided a prior assessment of access has been completed to address any concerns. Traction aids shall be in place prior to any Excavation activity.

3.1.4 EXCAVATION EQUIPMENT FOR LIFTING

When using excavating equipment (e.g., gradalls, backhoes) for material lifting, follow these requirements:

- Only a factory-supplied lift point shall be used, e.g., a welded plate with an eye, or a bolted-on hook with a safety latch;
- Slings shall be connected to the lifting point of the load with a clevis or shackle;
- Unattended loads shall be grounded or blocked in position;
- Ensure the lifting capacity chart for the specific piece of equipment is permanently affixed to the machine and legible and visible to the operator;
- Ensure a magnetic particle inspection report, dated within the previous twelve months. The report shall certify the fit condition of the lifting point and its method of attachment, e.g., welds, bolts;
- Visually inspect the lifting point before each lift;
- Ensure bolts used to attach hooks or other attachment points are rated higher than the lifting capacity of the lifting equipment;
- Ensure materials/load is always in motion and not suspended due to potential for hydraulic drift unless equipped with a manufacturer-installed lock valve; and
- The load should be lowered to the ground when the equipment is unattended.

3.1.5 SIDE BOOMS

Side booms shall:

- Not be loaded beyond manufacturer's specified capacity;
- Not have the counter weight supplemented by the use of equipment or other devices;
- Have a seat belt which shall be worn by the operator when the side boom is in use;
- Be equipped with roll over protection structure certified by a professional engineer;
- Have adjustment of brake tensions performed by a qualified heavy duty mechanic, in accordance with the manufacturer's specifications;
- Shall have the hydraulic shut-off switch engaged (when equipped) when the unit is left unattended and idling;

- Have tracks on the ground at all times;
- Sufficient load line on the drum to be able to safely handle pipe on deep ditch or bell holes;
- When it is necessary to stage/park heavy equipment on or near a slope, appropriate controls must be put in place;
- Function tests all safety devices (i.e. hydraulic shutoff pin, kickout pin, brakes, clutches etc.);
- Have a daily check completed on the functioning of the boom cut-out valve; and
- Not have carried loads secured by using the boom lines.

3.1.6 BOOM/ PICKER TRUCKS

When a boom/picker truck is traveling around the site, ensure booms and knuckles are in a proper resting position, to avoid damage or hazards, such as overhead power lines or cable trays.

Loads carried on boom trucks shall:

- Be adequately secured to prevent movement in the event of a roll-over; and
- Not be secured by using the boom lines.

3.1.7 DITCHING MACHINES

Follow these requirements related to ditching machines:

- Follow manufacturers' recommendation when wiping, oiling, adjusting cleaning, or repairing the machine;
- Shut down all power units before leaving the controls when the operator is required to carry out any of the above-mentioned functions unassisted;
- Operate ditching machines only if machine guards are installed and properly maintained;
- Keep helpers in sight or know where they are at all times when operating ditching machines;
- Do not undertake manual cleaning of buckets when the digging wheel is in operation; and
- Do not leave the controls of the machine unless the main transmission and digging wheel are out of gear and the traveling brakes set.

3.1.8 CRANES

General Crane requirements:

A crane shall only be erected when ground conditions are safe enough to allow for stable/firm placement and all other potential hazards have been eliminated or controlled.

All cranes shall have a power-controlled lowering system that is capable of handling rated loads and speeds as specified by the manufacturer of the crane. When power-operated brakes that have no continuous mechanical linkage between the actuating and braking means are used, an automatic means shall be provided to set the brake to prevent the load from falling in event of loss of brake-actuating power.

Guards shall be used:

- If hoisting ropes run close enough to other parts to make fouling or chafing possible; and
- When exposed moving parts and rotating equipment which might constitute a Hazard under normal operating conditions.

Crane Operators shall follow these requirements:

- When a crane is traveling around the site, carry the boom in line with the direction of travel and ensure booms are in a proper resting position. If this is not possible, then perform a hazard assessment and comply with controls;
- When traveling, ensure lock pin in place (positive house lock engaged);
- Lower conventional crane booms with the winch engaged, not by brake alone (not for hydraulic cranes);
- Maintain the safe limits of approach to any utility at all times;
- Ensure an unloaded boom has the empty hook lashed or otherwise restrained so that it cannot swing freely when in motion;
- Ensure the boom attachment, when in motion, is not positioned at more than 30 degrees from the vertical position;
- Cranes shall be equipped with an anti-two-block warning device;
- Check the brake when lifting the load above ground level; if there is any slippage, stop the operation. The brake shall be repaired or replaced before the equipment is returned to service; and
- Follow manufacturers' specifications in regards to reduced ratings or capacities of the crane under specified temperatures.

Crane Inspections

All Cranes shall:

- Have annual inspection record readily available;

Uncontrolled if Printed or Downloaded

- Have a current equipment log book readily available; and
- Have all written records including all certifications, maintenance records, inspection records for lifting equipment readily available.

Any lifting component shall be inspected annually using one of the following non-destructive testing methods:

- X-ray;
- Magnetic particle; and
- Dye penetration.

Wire ropes on electric hoists shall be inspected to confirm:

- Hoisting ropes are secured to the drum by at least 2 wraps when the hook is in the lowest position;
- Winch lines are free of knots; and
- The number and spacing of clips conforms to manufacturers' specifications.

Intern or apprentice operators may be permitted to operate equipment once hoisting and rigging training has been completed, but only under the supervision of a qualified operator.

3.2 EQUIPMENT INSPECTION

Follow these requirements for inspections:

- For equipment in normal service, inspect at least once per year, or as specified by the manufacturer;
- For equipment in heavy service, inspect at least every 6 months, or as specified by the manufacturer;
- For equipment that is idle for 6 months or more, a full formal inspection prior to use;
- For vacuum lifts, inspect 3 times daily and document; to ensure the integrity of the equipment;
- All pipe vacuum lifts shall have inspection certification; and
- Hoists, cranes and lifting equipment that include hooks, in accordance with the manufacturers' specifications' shall be inspected by a competent person before use and at least once annually by a certified inspector.

Pre-use Inspection

All pre-use inspections shall include but are not limited to:

- A walk-around of the equipment,
- A documented pre-use inspection:

Uncontrolled if Printed or Downloaded

- Controls, indicators and warning lights;
- Limits of the equipment;
- Equipment blind spots.
- Proper adjustment of operating mechanisms;
- Excessive wear or deterioration of components and accessories (e.g., cranes, boom pins, sheave blocks); and
- Damage that prohibits the safe operation of the equipment.

Inspect hydraulic hoses, fittings and tubing (particularly hoses that flex in normal operation) for the following:

- Leaks at threaded or clamped joints;
- Leaks at the surface of flexible hose; and
- Blistering of hoses.

Hydraulic relief valve settings shall never exceed specified pressure.

Equipment deficiencies shall be reported to immediate supervisor. If deficiencies pose a potential safety hazard, the equipment shall not be operated until cleared by a certified mechanic.

3.3 SIGNALERS AND SPOTTERS

Signalers/spotters shall be used when:

- Parts of the work area could potentially be obscured;
- Equipment is backing up or moving, and the operator cannot see all parts of the equipment and its path of travel;
- Equipment is backing up or moving in congested areas;
- Equipment make turns with restrictive side clearances;
- Equipment or parts of equipment may reach the safe limits of approach (e.g. overhead power lines and communication lines),
- Movement of equipment may result in the operator and/or other Workers being exposed to additional Hazards; and
- Excavating.

The Signaler/ Spotter shall:

- Stop equipment when hazards are observed, and inform operators and Workers of people entering the immediate work area;
- Communicate with the operator, either verbally or through agreed upon hand signals;

- Ensure there are no hazards present that might endanger a worker;
- Alert workers to any hazards that arise while material is being moved when the view of the operator is obscured;
- Establish and maintain eye contact with the operator;
- Remain clearly visible to the operator at all times;
- Stand far enough behind, or in front of, the equipment to observe the positioning/backing path and any obstructions, and to allow for sufficient stopping distance in an emergency;
- Stay clear of the equipment blind spots or line of fire and not walk backwards;
- Be clearly identified, distinguishable from other Workers, by wearing, at a minimum, *Class 2 HVSA*; and
- Complete any prescribed training required by applicable legislation in the jurisdiction where the signaler/ spotter is performing signaling duties.

Hand signals shall:

- Be used by the signaler/spotter when directing equipment; and
- Be agreed upon and understood by both the operator and signaler/spotter prior to moving equipment.

The operator shall take direction from only one signaler. However, anyone can give a STOP signal and the operator and/or spotter shall comply.

Communication between the operator and signaler/spotter shall be maintained. If the ability to transmit signals is interrupted at any time, the operator shall safely stop operations requiring signals until communication is re-established and a proper signal is given and understood. If eye contact is not possible or more than one spotter/signaler is used, a means of communication shall be established as part of the hazard assessment. If electronic communication is required, then that equipment shall be tested on-site before beginning operations to ensure that the signal is effective, clear and reliable.

<End of Document>



Contractor Safety Specification

Respiratory Protection

Table of Contents

1.0	Definitions & Acronyms	2
2.0	Contractor Responsibilities	3
3.0	Specification Requirements	4
3.1	Respirator Selection	4
3.1.1	Voluntary Use of Filtering Facepiece Respirators (“Dust Masks”).....	5
3.2	Medical Evaluation	5
3.3	Fit Testing	6
3.4	Respirator Use	6
3.4.1	Air Purifying Respirators.....	6
3.4.2	Self-Contained Breathing Apparatus (SCBA).....	7
3.4.3	Use of Supplied Breathing Air and Systems Requirements	7
3.5	Maintenance and Care of Respirators.....	7
3.5.1	Cleaning	7
3.5.2	Storage.....	7
3.5.3	Inspection	8
4.0	Training	8
5.0	References.....	8
6.0	Appendix	10
6.1	Facial Hair Examples	10
6.2	Supplied Breathing Air and Systems Requirements	11
6.3	RPE For Exposure Concentrations Table	13

1.0 DEFINITIONS & ACRONYMS

Action Level—half of an occupational exposure limit.

Air-Purifying Respirator—a respirator with an air-purifying filter, cartridge or canister that removes specific air contaminants by passing the air through the purifying element.

Assigned Protection Factor (APF)—the workplace level of respiratory protection that a respirator or class of respirators is expected to provide to workers when the employer implements a continuing, effective respiratory protection program.

Canister or Cartridge—a container with a filter, sorbent, or catalyst, or combination which removes specific contaminants from the air passed through the container.

Enbridge- Enbridge, Inc. and Enbridge (U.S.) Inc., hereinafter will be referred to as “Company”.

Engineering Controls—physical changes to equipment and operations to reduce exposure to air contaminants. Engineering controls may include: adding local exhaust ventilation, changing to better equipment that release less air contaminants and enclosing operations to prevent exposure.

Filtering Facepiece (Dust Mask)—a negative pressure particulate respirator with a filter as an integral part of the facepiece or with the entire facepiece composed of the filtering medium.

Fit Test—a protocol for the qualitative or quantitative evaluation of the fit of a respirator on an individual.

Immediately Dangerous to Life or Health (IDLH)—an atmosphere that poses an immediate threat to life, would cause irreversible adverse health effects, or would impair an individual’s ability to escape from a dangerous atmosphere.

Negative Pressure Respirator (Tight Fitting)—a respirator in which the air pressure inside the facepiece is negative during inhalation with respect to the ambient air pressure outside the respirator.

NIOSH “Certified” Respirator—a respirator meeting the requirements of 42 CFR Part 84. All respirators approved by NIOSH have an approval number that looks like this: TC-84A-111 or TC-23C-222. A respirator is “approved” for a specific set of circumstances and conditions. If the particular circumstances or conditions of use exceed those for which it was approved, the respirator may provide inappropriate protection and is no longer considered to be approved. The following are examples of things you can do to invalidate the approvals: altering the respirator in any way such as by removing a strap or interchanging parts; using an air-purifying respirator equipped with organic vapor cartridges for an organic vapor with poor warning properties; using an air-purifying respirator equipped with organic vapor cartridges for an organic vapor at concentrations above the maximum use concentration established by OSHA or NIOSH.

NIOSH—National Institute for Occupational Safety and Health

Occupational Exposure Limit (OEL)—a regulatory limit that sets a standard measure that shall not be exceeded for specific contaminants and work durations (usually a 15 minute or 8 hour time weighted average).

Oxygen Deficient Atmosphere—an atmosphere with oxygen content below 19.5% by volume.

Physician Or Other Licensed Health Care Professional (PLHCP)—an individual whose legally permitted scope of practice (i.e., license, registration, or certification) allows him or her to independently provide, or be delegated the responsibility to provide, some or all of the health care services required

Positive Pressure Respirator—a respirator in which the pressure inside the respiratory inlet covering exceeds the ambient air pressure outside the respirator (e.g. powered air purifying respirators).

Powered Air-Purifying Respirator (PAPR)—an air-purifying respirator that uses a blower to force the ambient air through air-purifying elements to the inlet covering.

Pressure Demand Respirator—a positive pressure atmosphere-supplying respirator that admits breathing air to the facepiece when the positive pressure is reduced inside the facepiece by inhalation.

Qualitative Fit Test (QLFT)—a pass/fail fit test to assess the adequacy of respirator fit that relies on the individual's response to the test agent.

Quantitative Fit Test (QNFT)—an assessment of the adequacy of respirator fit by numerically measuring the amount of leakage around the face seal of a respirator.

Self-Contained Breathing Apparatus (SCBA)—an atmosphere-supplying respirator for which the breathing air source is designed to be carried by the user.

Supplied-Air Respirator (SAR) or Airline Respirator—an atmosphere-supplying respirator for which the source of breathing air is not designed to be carried by the user.

2.0 CONTRACTOR RESPONSIBILITIES

Contractors shall:

- Have a written respiratory protection program that meets or exceeds this specification and all applicable legislation and provide their workers with all required respiratory equipment;
- Provide proof of medical evaluation upon request; and
- Provide fit testing to contractor personnel (by respective employer).

3.0 SPECIFICATION REQUIREMENTS

For protection from airborne contaminants, Workers shall wear respiratory protection equipment (RPE), in accordance with this specification. Airborne contaminants and hazards can include, but are not limited to:

- Particulates (asbestos, silica);
- O₂ deficiency;
- Fumes;
- Gases or vapors;
- Smoke; and
- Sprays.

Workers may be required to wear any of the following, depending on the potential hazard:

- Self-Contained Breathing Apparatus (SCBA);
- Supplied-Air Respirator (SAR) or Supplied-Air Breathing Apparatus (SABA); and
- Air-Purifying Respirators (APR) (full-face, half-mask, or disposable).

Tight fitting respirators seal. Workers shall ensure that no items (e.g. facial jewelry) or facial hair impede the seal or use of the respirator. Workers who are required to wear tight fitting respirators as per hazard assessment shall be clean-shaven where the face piece contacts the skin (reference Appendix 6.1). Facial hair is allowed as long as it does not protrude under the respirator seal, or extend far enough to interfere with the device's valve function.

Workers who must wear tight fitting full face respirators and require prescription lenses shall wear an appropriate eyeglass insert that can be used with the face piece.

3.1 RESPIRATOR SELECTION

A hazard assessment of the work area shall be conducted to determine the respiratory hazards present. The following factors shall be considered during the hazard assessment before selecting the type of respiratory protection:

- Oxygen concentration;
- Nature & physical state of airborne contaminants or biohazardous material;
- Concentration of airborne contaminants;
- Duration of worker exposure;
- Operators conditions, processes or tasks;
- Warning properties of the contaminants;

- Toxicity of the contaminants;
- Need for emergency escape;
- Cartridge end of service indicators / change out schedule;
- LEL and IDLH levels of contaminants; and
- Facilities sufficient to adequately clean, sanitize, and properly store the respirator after use.

Only respirators approved by the National Institute for Occupational Safety and Health (NIOSH) shall be used. Specific respirator types and cartridges to be used shall be determined based on an initial hazard assessment, initial air monitoring, past documented exposure data, Safety Data Sheets (SDS), and/or exposure modelling. Recommendations on respirator types per air sampling/monitoring results are provided in appendix 6.3.

If the concentration of the contaminant is unknown or there is a potential for a hazardous atmosphere (e.g., work around Open Systems), assume the atmosphere is hazardous, perform exposure assessments and use RPE in accordance with Appendix 6.3).

Planned work should not take place in immediately dangerous to life and health (IDLH) environments. If an IDLH environment exists, or has potential to exist, then work shall stop until controls are in place to eliminate, control or minimize the hazards to an acceptable level. To avoid working in IDLH environments, use the Hierarchy of Controls (engineering, administrative, PPE) to mitigate atmospheric hazards. If the Hierarchy of Controls does not mitigate atmospheric hazards to an acceptable level, then Contractors shall contact Company Representative for further information.

Note: IDLH values for common chemical exposures may be found in Appendix 6.3. A source of IDLH values for other chemicals may be found in the National Institute of Occupational Safety and Health online Pocket Guide: <https://www.cdc.gov/niosh/npg/default.html>

3.1.1 VOLUNTARY USE OF FILTERING FACEPIECE RESPIRATORS (“DUST MASKS”)

Contractors may choose to voluntarily use filtering facepiece respirators (dust masks) for minor maintenance activities for the prevention of nuisance dusts or particles.

3.2 MEDICAL EVALUATION

Prior to the use of respiratory protection equipment (including fit testing), a medical evaluation of the worker shall be completed and reviewed by a licensed healthcare professional.

3.3 FIT TESTING

Fit testing is required for all respiratory protection that depends on an effective facial seal prior to initial use in the workplace (tight fitting respirators). Fit testing shall be completed for each size and model of respirator used by the worker. Fit testing shall be carried out on an annual reoccurring basis as set by applicable regulations.

Fit testing should be quantitative (preferred method), and fit testing procedures shall be completed by a trained individual that must follow procedures as set forth in applicable regulations (CSA Z94.4 Annex B, OSHA appendix A).

When respirators used for fit testing are not individually assigned, cleaning and sanitizing shall be performed before the next use.

3.4 RESPIRATOR USE

Where there is an existing or potential for an atmospheric hazard:

- Continuous monitoring of the work area shall occur to ensure atmospheric conditions don't change. If atmospheric conditions significantly change, the hazard assessment shall be updated and additional controls put in place, including reassessing the level of RPE being used per appendix 6.3.
- Appropriate surveillance shall be maintained of work area conditions and degree of Worker exposure or stress. When there is a change in work area conditions or degree of worker exposure or stress that may affect respirator effectiveness, the site supervisor shall reevaluate the continued effectiveness of the respirator.
- Respiratory protective equipment must be used as per manufacturer's instructions and is not to be modified in any way.

3.4.1 AIR PURIFYING RESPIRATORS

Workers required to wear tight fitting respirators shall:

- Perform a positive and negative pressure user seal check, prior to use;
- Select or change the RPE used, based on results of contaminant/Hazard monitoring and updated results;
- Leave the respirator use area if vapor or gas breakthrough is detected, or if there are changes in breathing resistance, or leakage of the face piece;
- Ensure that shared RPE is disinfected after each personal use; and
- Leave the area to change cartridges.

3.4.1.1 Cartridge Change Out:

Workers wearing air purifying respirators (APR) shall replace cartridges when:

- Cartridge has been used for escape from H₂S concentrations greater than (>) 10 ppm;
- Cartridge is damaged;
- There is odor breakthrough;
- Cartridge is past the expiration date;
- Cartridge usage exceeds manufacturers specifications;
- Cartridge is plugged, damaged or soiled; and
- Hazard Assessment determines cartridges require replacement.

If used in environments containing oil aerosols, the worker shall replace an oil proof filter (P type aerosol filters such as the “P100”) when it exceeds manufacturers specifications.

3.4.2 SELF-CONTAINED BREATHING APPARATUS (SCBA)

All SCBA respirators shall be of the positive pressure type.

Workers wearing SCBA or SAR with escape pack shall:

- Be properly trained and fit tested prior to using the equipment;
- Leave the area containing the Hazardous Atmosphere when the alarm sounds or when 20–25% of the operating time remains (SCBA); and
- Not remove the face mask while in the area containing the Hazardous Atmosphere.

3.4.3 USE OF SUPPLIED BREATHING AIR AND SYSTEMS REQUIREMENTS

Workers using supplied air systems shall have a bottle watch to ensure constant breathing air supply to workers at all times when using supplied air.

Compressed air breathing systems air quality must meet additional regulatory requirements. Refer to Appendix 6.2 for additional information.

3.5 MAINTENANCE AND CARE OF RESPIRATORS

3.5.1 CLEANING

Workers shall clean and disinfect their respirators after each use per manufacturer recommendations.

3.5.2 STORAGE

All respirators shall be stored to protect them from damage, contamination, dust, sunlight, extreme temperatures, excessive moisture, and damaging chemicals.

3.5.3 INSPECTION

All respirators shall be inspected prior to use and during cleaning.

All respirators maintained for emergency use shall be inspected on a monthly basis or in accordance with manufacturer's recommendations, and shall be checked for proper function before and after each use.

Workers shall inspect and record information about SCBA and SAR escape packs on a monthly basis. The inspection and information shall include labeling each respirator or storage bag with:

- Inspection date;
- Name of Worker completing the inspection;
- Findings, including remedial action required; and
- Serial number or other identification.

All required documented Inspection records shall be kept on-site for one year.

4.0 TRAINING

Contractors working in the field must be knowledgeable in this Specification.

Training shall be completed initially and annually thereafter for all workers required to use respirators as part of their job functions. Training shall include at a minimum the following:

- When to use the respirator;
- Proper fit of the respirator;
- The limitations and capabilities of the respirator;
- Effective use of the respirator during emergencies;
- Maintenance and storage of the respirator to include inspection;
- Recognition of medical signs and symptoms that may limit or prevent the effective use of the respirator;
- When to change-out respirator cartridges, and
- Use of respirators in low temperature and extremely low temperature environments.

5.0 REFERENCES

Canada Labour Code, Part II: Respiratory Protection 12.7

CSA Z94.4 Selection, Use, Care of Respirators

OSHA 1910.134 Respiratory Protection



6.0 APPENDIX

6.1 FACIAL HAIR EXAMPLES

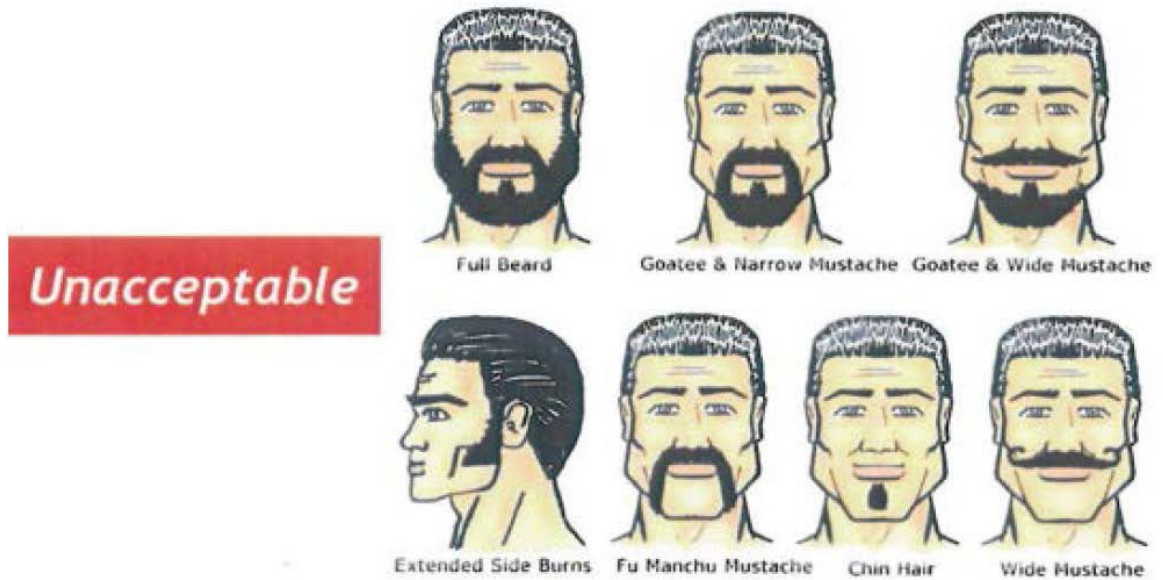
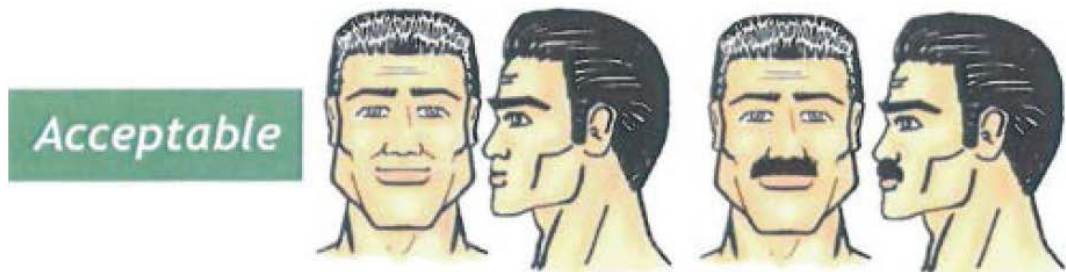

Other acceptable examples may be found in CSA 94 appendix M or <https://www.cdc.gov/niosh/npptl/images/infographics/FacialHairWmaskLG.jpg>

6.2 SUPPLIED BREATHING AIR AND SYSTEMS REQUIREMENTS

Compressed breathing air and systems used to supply breathing air to RPE shall meet the requirements of:

- CSA Z180.1 Compressed breathing air and systems (CAN), and/or
- ANSI/Compressed Gas Association Commodity Specification for Air, G-7.1 (USA) (OSHA 1910.134(i)(1)(ii))

The compressed breathing air shall be sampled and analyzed as per industry standards and applicable legislation. The air quality analysis results shall be readily available. Compressed breathing air and systems shall be inspected and maintained in accordance with manufacturers' specifications, applicable legislation and industry standards. Written records of analysis results, inspections and maintenance shall be kept according to the record retention policy.

Carbon monoxide levels shall be continuously monitored with an in-line monitoring system for compressed breathing air systems using oil-lubricated compressors. This in-line monitoring system shall consist of:

- Audible or/and visible alarms at 5 ppm,
- Detection limit of 1 ppm and a resolution of at least 1 ppm, and
- An inspection, maintenance and calibration program in accordance with manufacturers' specifications.

In-line carbon monoxide monitoring is not required for Ambient Air Systems or compressed breathing air systems comprised of compressed breathing air cylinders which have been filled in accordance with the applicable legislation.

In case ambient air systems are being operated in an environment where CO could get externally introduced into the system (running engines in the vicinity, etc.) the ambient air shall be tested for CO close to the air intake at least two times daily and when environmental or job conditions change.

Oil-lubricated air compressors used as a component of a compressed breathing air system shall:

- Have fail-safe switches that will activate audible and visual alarms, shut down the compressor, and prevent automatic restart when either the compressor's oil pressure is low or temperature is high,
- Have a high pressure shutdown switch,
- Have check valves to prevent feedback of purified air,
- Have an instruction manual and manufacturer's recommended logbook, and
- Use oils for breathing air applications that are recommended by both the compressor and oil manufacturers.

The air intake for the compressed breathing air system shall be situated and installed in accordance with manufacturer's specifications and designed to minimize the intake of contaminants. Atmospheric Monitoring of the work area may be required to ensure atmospheric contaminants are not drawn into the compressed breathing air system.

Breathing air couplings shall be incompatible with outlets for non-respirable worksite air or other gas systems.

Steel and aluminum SCBA Cylinders and emergency escape pack cylinders shall be hydrostatically tested every 5 years by a qualified service supplier. All other cylinders (e.g., carbon and fiberglass) shall be hydrostatically tested every three years by a qualified service supplier. Each SCBA shall be functionally tested in accordance with the manufacturer's specifications.

Cylinders for hoseline breathing equipment shall be equipped with a pressure-reducing regulator to control hoseline pressure below 1380 kPa (200 psi).

Breathing Hoselines/Airlines shall:

- Be a certified and compliant hose as rated and supplied by the manufacturer,
- Be protected from tangles, unnecessary wear and damage,
- Have fully-functional quick connectors with dual action locking fittings at all times (single action locking fittings shall not be permitted for use), and
- Not exceed the length per the manufacturer recommendations or a maximum of 91 m (300 ft.) in length with a maximum of 12 segments.

6.3 RPE FOR EXPOSURE CONCENTRATIONS TABLE

Respiratory Hazard	Exposure Concentration	Respiratory Protection
Asbestos	<1 f/cc	half-mask APR with P100 filter
	1 to 10 f/cc	full-face APR with P100 filter
	10 to 100f/cc	full-face PAPR with P100 filter or SAR
	<1000f/cc	positive demand or positive pressure SCBA
Benzene	0 to 0.5 ppm	none
	0.6 to 5 ppm	half-mask APR with OV cartridge
	6 to 25 ppm	full-face APR ¹ with OV cartridge or SAR
	greater than (>) 25 ppm	SCBA or SAR
	greater than (>) 500 ppm (IDLH) ²	planned work is not permitted ³
Carbon monoxide	25 ppm to 500 ppm	SCBA or SAR
	greater than (>) 500 ppm	planned work is not permitted ³
Hydrogen Sulfide (H ₂ S)	0 to 10 ppm	None
	11 to 99 ppm ⁵	SCBA or Type C SAR with escape pak ⁶
	greater than (>)100 ppm (IDLH) ²	Planned work is not permitted ³
Lead (0.05mg/m ³)	<0.05 mg/m ³	half mask APR with P100 filter
	0.05 to 5 mg/m ³	full face APR with P100 filter
	5 to 50 mg/m ³	full face PAPR with P100 filter or SAR
	50 to 100 mg/m ³	Positive demand or positive pressure SCBA
	greater than or equal to (≥) 100mg/m ³	planned work is not permitted
Mercaptans	0 to 0.5 ppm	none
	0.6 to 5 ppm	half-mask APR with OV cartridge
	6 to 25 ppm	full-face APR ¹ with OV cartridge or SAR
	greater than (>) 25 ppm	SCBA or SAR
	greater than (>) 500 ppm (IDLH) ²	planned work is not permitted
Natural gas	0 to 10% LEL	none
	11 to 20% LEL	SCBA for cold work; hot work is not permitted ⁶
	greater than (>) 20%	planned work is not permitted ³
Oxygen deficiency	less than (<) 19.5%	SCBA
Petroleum vapors	less than (<) 3% LEL	None
	greater than or equal to (≥) 3% LEL to less than (<) 10% LEL	half-mask APR with OV cartridge

Respiratory Hazard	Exposure Concentration	Respiratory Protection
	greater than or equal to (\geq) 10% LEL to less than ($<$) 20% LEL	SCBA (or equivalent) for cold work; hot work is not permitted
	greater than or equal to (\geq) 20% LEL (IDLH)	planned work is not permitted ³
Silica (Exposure Limit .025)	$<0.25\text{mg}/\text{m}^3$	half-mask APR with P100 filter
	0.25 to $2.5\text{mg}/\text{m}^3$	full-face APR With P100 filter
	2.5 to $25\text{mg}/\text{m}^3$	full-face PAPR with P100 filter or SAR
	greater than or equal to (\geq) $25\text{mg}/\text{m}^3$ (IDLH)	planned work is not permitted

Notes

- 1 If quantitative fit test performed.
- 2 Immediately Dangerous to Life and Health (IDLH)
- 3 Emergency work is allowed if SCBA or SAR with escape pack is used and all ignition sources are eliminated. Additional requirements for entering buildings can be found in section 4.18
- 4 If the concentration exceeds the maximum detection limit of the H₂S detector, planned work is not permitted until the concentration has been verified.
- 5 Where possible, reset gas detectors monitoring H₂S to alarm at 10 ppm (low level) and 20 ppm (high level).
- 6 Natural gas is composed of 95% methane. Methane is a simple asphyxiate; therefore does not have an allowable exposure limit. Methane displaces oxygen in the atmosphere; therefore, entry into areas where oxygen levels are less than ($<$) 19.5% require SCBA.

<End of Document>



Contractor Safety Specification

Right to Refuse
Dangerous Work

Table of Contents

1.0	Definitions & Acronyms	2
2.0	Contractor Responsibilities	2
3.0	Specification Requirements	2
3.1	Contractor Worker Right to Refuse Dangerous Work	2
3.2	Contractor Notification to Company of Workers Right to Refuse Dangerous Work Event	3
4.0	References.....	3

1.0 DEFINITIONS & ACRONYMS

Dangerous Work—any hazard, condition or activity that could reasonably be expected to be an imminent or serious threat to the life or health of a person exposed to it before the hazard or condition can be corrected or the activity altered. The hazard, condition and/or activity that is considered dangerous cannot be a normal condition of employment.

Enbridge- Enbridge, Inc. and Enbridge (U.S.) Inc., hereinafter will be referred to as “Company”.

2.0 CONTRACTOR RESPONSIBILITIES

Contractor Management shall:

- Ensure workers remain in compliance with OH&S acts and regulations;
- Ensure workers understand their right and responsibility to refuse dangerous work;
- Ensure workers use prescribed protective equipment devices;
- Advise workers of potential and actual hazards;
- Provide workers measures and procedures to be taken to address the hazard, condition or activity that is an imminent and immediate threat to life and health;
- Take every reasonable precaution in the circumstances for the protection of workers at the worksite; and
- Complete investigation and corrective actions as applicable.

Workers shall:

- Work in compliance with OH&S acts and regulations;
- Knowledgeable in this specification and willing to enact it when required on the worksite;
- Use personal protective equipment and clothing as required;
- Report workplace hazards and dangers to the Company as required;
- Work in a safe manner as required and use the prescribed safety equipment; and
- Notify Contractor Management about any missing or defective equipment or protective device that is an imminent or serious threat to the life or health.

3.0 SPECIFICATION REQUIREMENTS

Any worker has the right and responsibility to refuse dangerous work as long as they have reasonable cause to believe that it presents a danger to themselves or another worker.

3.1 CONTRACTOR WORKER RIGHT TO REFUSE DANGEROUS WORK

Uncontrolled Copy if Printed or Downloaded

Internal Information

A contractor worker wishing to exercise the right to refuse dangerous work shall immediately report the dangerous situation to Contractor Management.

It is against the law to dismiss, suspend, layoff, demote, impose a financial or other penalty, discipline or threaten any employee performing their rights or duties to refuse dangerous work.

However, Contractors have the legal right to take disciplinary action against a worker if the Contractor can prove the worker wilfully abused their right to refuse dangerous work.

3.2 CONTRACTOR NOTIFICATION TO COMPANY OF WORKERS RIGHT TO REFUSE DANGEROUS WORK EVENT

Contractors shall notify Company of all workers Right to Refuse Dangerous Work events.

4.0 REFERENCES

OSHA, Discrimination against Employees under OSHA Act of 1970, 1977.12

Canada Labor Code, Right to Refuse Dangerous Work, s. 122,128,129,146,147)

<End of Document>

Uncontrolled Copy if Printed or Downloaded

Internal Information



Contractor Safety Specification

Safe Limits of Approach
& Entry – Power Lines &
Substations



Table of Contents

1.0	Definitions & Acronyms.....	2
2.0	Contractor Responsibilities	4
3.0	Specification Requirements	5
3.1	Planning	6
3.2	Safe Limit of Approach Distances	8
3.3	Overhead Power Lines.....	10
3.3.1	Equipment Hauling and Moving Under Overhead Power Lines	10
3.4	Signs & Barriers	12
3.5	Best Practices for High Risk Work	13
3.5.1	Heavy Mobile Equipment	13
3.5.2	Tree Trimming Work.....	13
3.5.3	Vehicles with Loads in Excess of a Height of 4.15 m (14 ft.).....	14
3.6	Emergency Response Plan.....	14
3.7	Authorization to Access Substation – Non Electrical Workers	15
4.0	References.....	16



1.0 DEFINITIONS & ACRONYMS

Danger Zone - The area extending 6 meters / 20 feet around Mobile Equipment including attachments, implements and booms at furthest extension.

Electric Utility Company - An organization that supplies electricity to other consumers through an isolated generating unit, transmission facility or an electric distribution system.

Electric Utility Representative - A competent worker representing the electric utility company that is the owner/operator of the power line(s), who shall advise of the necessary Safe Limit of Approach distances and other required information respecting the overhead power line

Electrical Work Tasks – Work activities with the intent to alter, operate, troubleshoot, install, or remove electrical components

Electrical Work Zone – An area where electrical work is being performed by a qualified electrical worker

Enbridge – Enbridge, Inc. and Enbridge (U.S.) Inc., hereinafter will be referred to as “Company”.

Energized - Electrically connected to or having a source of voltage.

Exposed - (as applied to energized electrical conductors or circuit parts) Capable of being inadvertently touched or approached nearer than a safe distance by a person. It is applied to electrical conductors or circuit parts that are not suitably grounded, isolated, or insulated.

Exposed Movable Conductor - describes a condition in which the distance between the conductor and a person is not under the control of the person.

High Voltage – >750VAC for Canada or >600VAC for the United States.

Inadvertent Movement Adder- Precautionary distance added to the minimum flashover (air insulation) distance based on experience and precautions for inadvertent movement. Minimum distances from exposed energized electrical conductors or circuit parts for workers to avoid exposure to electric shock due to flashover. Limited Approach Boundary, Shock: An approach limit at a distance from an exposed energized electrical conductor or circuit part within which a Shock hazard exists.

Limit of Approach (LOA) – Minimum distances from exposed energized electrical conductors or circuit parts for workers to avoid exposure to electric shock due to flashover. They include dimensions that are added to a basic minimum air insulation distance.

Low Voltage - <750VAC for Canada or <600VAC for the United States.

Minimum Approach Distance (MAD) – Minimum safe distances from exposed energized electrical conductors or circuit parts for workers to avoid exposure to electric shock due to flashover. They include dimensions that are added to a basic minimum air insulation distance.



Mobile Equipment - Operator-driven vehicles other than normal transport vehicles (e.g., cars, trucks) used to perform work at a worksite whether electric, gasoline, Compressed Natural Gas, diesel, or propane powered. Includes but is not limited to tractor trailer units, forklift trucks, front-end loaders, tracked vehicles, cranes, dump trucks, etc.

Non-Electrical Worker (NEW) - One who does not meet the criteria of a Qualified Electrical Worker.

Operator-in-Charge - An individual that is knowledgeable and experienced in the operation of high voltage substations who has been assigned the responsibility for the operation of the electrical system. Has authority within their jurisdiction to approve or reject work performed on the electrical system. Is responsible for maintaining the requirements of the Interconnection Agreement if one is in place with other electrical systems.

Qualified - One who, by possession of a recognized degree, certificate, or professional standing, or who by knowledge, training and experience, has successfully demonstrated his ability to solve or resolve problems relating to the subject matter, the work, or the project

Qualified Electrical Worker (QEW) - One who has demonstrated skills and knowledge related to the construction, operation and maintenance of electrical equipment and installations. Depending on jurisdiction, may have to be a certified Journeyman Electrician.

Qualified Spotter - A worker whose explicit role is to observe a Qualified Person's interaction with electrical equipment and warn operators when they are about to encroach into the Limits of Approach or Minimum Approach Distance surrounding overhead or underground powerlines, assets and other electrical apparatuses.

Qualified Operations Representative- A people leader, supervisor or designate representing the company

Restricted Approach Boundary, Shock - An approach limit at a distance from an exposed energized electrical conductor or circuit part within which there is an increased likelihood of shock, due to electrical arc over combined with inadvertent movement, for personnel working in close proximity to the energized electrical conductor or circuit part.

Safe Limit of Approach - Threshold distance established in all directions around an overhead power line in which encroachment of any portion of equipment, loads, rigging, or attachments or the approach of personnel is prohibited. Unless otherwise established by an Electric Utility Representative, the minimum Safe Limit of Approach is 33ft. (10.0 m).

Step Potential – Is the step voltage between the feet of a person standing near an energized grounded object (e.g. overhead power line). It is equal to the difference in voltage, given by the voltage distribution curve, between two points at different distances from the electrode.

Substation – Shall mean an integrated unit consisting of one or more transformers, disconnecting means, overcurrent devices, and other associated equipment, each contained in a suitable

enclosure designed and constructed to restrict access to live parts. There will also be exposed overhead systems that connect the electrical equipment to the transmission or distribution systems.

Touch Potential – Is the touch voltage between the energized object and the feet of a person in contact with the object. It is equal to the difference in voltage between the object and a point some distance away.

Unique Pole Identifier - Alphanumeric naming convention utilized by the utility company to identify the pole location.

Utility Tree Trimmer – A Qualified Worker who specializes in the maintenance and removal of trees and other vegetation to ensure the proper function of electrical overhead power lines and equipment without interference.

2.0 CONTRACTOR RESPONSIBILITIES

Contractor Management:

- Ensure that workers, and subcontractors under their control are aware of and comply with this Specification
- Ensure that all required resources to effectively implement this Specification are readily available
- Ensure that only qualified workers are designated to support the execution of this Specification as required
- Develop their own power line encroachment policies and procedures incorporating all applicable regulatory requirements and the requirements set out in this Specification
- Ensure the requirements of this Specification are reflected within their Safe Work Plan
- Ensure workers are trained on their roles and responsibilities as outlined in this Specification
- Conduct formal and informal site inspections and safety observations to verify the use of this Specification. Ensure workers are trained on their roles and responsibilities as outlined in this Specification

Contractor Equipment Operators | Workers:

- Review the work scope, drawings, and hazard assessment to ensure potential site hazards are identified and addressed as required prior to beginning work.
- Operate the mobile equipment under the guidance of the designated Qualified Spotter and discontinue operation when anyone signals an emergency stop or when the Qualified Spotter is no longer visible

- Ensure the mobile equipment has a conspicuous warning decal regarding electrical contact displayed within the cab/at the controls
- Review with the Qualified Spotter the height, width and maximum reach of the mobile equipment
- Establish and maintain reliable communication with the Qualified Spotter.
- Establish and verify with the Qualified Spotter recognizable hand signals that will be used during the work

Contractor Qualified Spotters:

- Know the height, width and maximum reach of the mobile equipment and the Safe Limit of Approach and will ensure that at no time is there a Safe Limit of Approach encroachment
- Establish and maintain reliable communication with the Equipment Operator
- Establish and verify with the Equipment Operator recognizable hand signals that will be used during the work
- Perform no other duties except to communicate with and direct the Equipment Operator and will only signal for one piece of mobile equipment at a time. Guidance for excavating or operating taglines will require a separate Qualified Spotter
- Responsible for stopping work if Safe Limit of Approach distances are being encroached upon or unsafe conditions are identified
- Wear a high visibility vest, harness, markings or use other methods to distinguish them from other workers.

3.0 SPECIFICATION REQUIREMENTS

Specific requirements related to Safe Limit of Approach and work practices within substations for non-electrical workers are mandated by Provincial, Federal, and State Occupational Health & Safety OH&S Acts, Standards, Codes & Regulations. This Specification has implemented the most stringent requirements within the jurisdictions that the Company currently operates within. However, if work is to commence within a regulatory body that has a more stringent regulatory requirement then that legislation must be adhered to. Contact the Company Safety Team for clarification as required. For electrical work tasks required to be completed within the safe limits of approach, reference the Electrical Safety Specification as described in section 3.2 of this document.

It is important that workers understand and acknowledge the presence of overhead power lines or buried cables prior to performing work in proximity to overhead power lines or excavation work that may put them in contact with energized conductors. It is critical that workers understand that working in proximity to energized overhead power lines or overhead systems in high voltage

substation can produce a fatal shock hazard exposure or create an arcing fault and arc flash that may cause a burn injury. You do not have to make contact to be exposed, your body and equipment you are using must stay outside the identified Limits of Approach. With this understanding it should be noted that all overhead power lines or overhead systems in high voltage substations should be considered energized unless otherwise directed. In general, if the line voltage is unknown, stay away a minimum of 10 m or 33 feet and contact the Electric Utility Company for assistance where applicable or the appropriate Contractor Leadership.

Prior to performing a ground disturbance, it is imperative that checks are conducted to ensure buried facilities such as electrical or fibre-optic cables are clearly identified prior to work commencement. Review the Ground Disturbance Specification for further direction if applicable to the work being planned.

Before work begins, conduct a hazard assessment and examine the work area to identify hazards and to establish that the Safe Limit of Approach distances to overhead power lines and overhead systems in high voltage substations contained in Table 1 Section 3.2 and ensure the Limits of Approach are NOT encroached.

Contact the Electric Utility Company to determine the operating voltage of the overhead power line and confirm the Safe Limit of Approach distances; also, request assistance from the Electric Utility Company if the work must be performed at a distance that is less than those specified in Table 1 Section 3.2. In this situation have the Electric Utility Company isolate or relocate the line if needed.

Work around overhead power lines or overhead systems in high voltage substations should only be done during daylight hours or with adequate artificial lighting. Poor visibility conditions (e.g., rain, snow, fog) may dictate modifications to the work and may preclude the continuation of work.

Overhead power lines or overhead systems in high voltage substations will be presumed to be energized unless the Electric Utility Company confirms that the overhead power line has been, and continues to be, de-energized and visibly grounded at the worksite. Material will not be offloaded and stored under or in the vicinity of overhead power lines. Areas within marshalling yards, storage facilities or rights-of-way in proximity to overhead power lines or overhead systems in high voltage substations, which may inadvertently be utilized as storage, will be cordoned off and signage erected to warn of the hazard.

When taglines are utilized, they will be made of non-conducting material such as dry rope.

3.1 PLANNING

Planning of work specific to addressing electrical hazards related to overhead power line or overhead systems in high voltage substations is a critical component to eliminating the potential for proximity or contacting an energized overhead power line or overhead systems in high voltage substations. Best practices for implementation prior to work execution include:

- Identify all overhead power lines or overhead systems in high voltage substations by reviewing drawings and conducting site visits and thorough site/area assessments prior to all work activity. This includes:
 - equipment offloading sites,
 - access routes to/from worksite,
 - material storage areas, in addition to the actual worksite(s).
- Mark the locations of overhead power lines on plans and drawings as applicable.
- Notify Electric Utility Companies (where applicable), allowing a minimum of 72 hours notice if the work will require mobile equipment to operate within the Safe Limit of Approach of an overhead power line or overhead systems in a high voltage substation. Longer lead time may be required if on-site support from the Electric Utility Company is necessary. Obtain Electric Utility Company advice for:
 - Confirming overhead power line voltage(s);
 - Confirming voltage(s) of overhead systems in high voltage substations;
 - Safe Limit of Approach distances (Note: 30 ft. (9 m) may be insufficient in some circumstances - advice from the Electric Utility Company Representative is critical);
 - Height of applicable overhead power lines (NOTE: actual height of overhead power lines may be less than the original installed height due to road improvements/grading, snow pack, line sag, etc.);
 - Procedures to obtain on-site Electric Utility representation or actions, if necessary;
 - Presence of and disablement of Autoreclosers;
 - Unique Pole Identifier;
 - Full isolation and issuance of a Guarantee of Isolation.

If surveying services are to be utilized, task the survey contractor with determining and documenting the height of overhead power lines at the planned crossing locations. Height of crossing will be marked on survey stakes at the location of the crossing or other comparable means to ensure communication.

Resource requirements should be planned for in advance, and may include additional personnel, signage, non-conductive ropes and guard poles (“goalposts”), appropriate communication devices for use by the Qualified Spotter, and Electric Utility Company Representative.

Identify, document and communicate all hazards and the applicable hazard control measures. Ensure that a copy of the hazard assessment is on site. Hazards may include:

- Equipment offloading and equipment and/or materials staging near overhead power lines or overhead systems in high voltage substations;
- Spoil piles;
- Open excavations;
- Dump trucks travelling with raised boxes;
- Crane booms;
- Trucks with over height loads;
- Pipelining heavy equipment;
- Poor visibility due to rain, snow or fog;
- Proximity to power poles and guy wires;
- Changes to work scope;
- Weather conditions like ice, extreme heat, etc. that may impact the powerlines

Signage and barriers are required if an overhead power line encroaches or travels parallel to the proposed worksite and potential exists for the Danger Zone of any Mobile Equipment to encroach on the Safe Limit of Approach.

Designate a Qualified Spotter(s) to guide the movement of equipment at any time potential exists for the Danger Zone of any Mobile Equipment to encroach on the Safe Limit of Approach of an overhead power line.

Assess crossing locations for terrain that may cause any Mobile Equipment or component to weave or bob increasing the likelihood of encroachment on the Safe Limit of Approach or contact with the overhead power line.

Note: Approach of any equipment within 10 ft. (3m) is prohibited under all circumstances.

3.2 SAFE LIMIT OF APPROACH DISTANCES

Workers shall maintain the Safe Limit of Approach distances as outlined in Table 1. These distances apply to Workers as noted, including their work involving tools, vehicles or equipment. A Qualified Spotter shall ensure the minimum Safe Limit of Approach distances are maintained by all workers and equipment in the area. As part of this duty, the Qualified Spotter shall monitor movements of all workers, tools and equipment when work is in progress near energized overhead power lines or overhead systems in high voltage substations.



3.2.1 LIMITED APPROACH BOUNDARY

Non-electrical workers must be accompanied by a qualified electrical worker when entering the limited approach boundary. At no time shall Non-electrical workers be allowed to cross the Restricted Approach Boundary.

3.2.2 RESTRICTED APPROACH BOUNDARY

Only Qualified Electrical workers can cross the Limited Approach Boundary but shall not cross the Restricted Approach Boundary without following the process outlined below:

When Electrical Work Tasks are required to be completed within the Restricted Approach Boundary, by an Electric Utility Company or Qualified Electrical Worker, the Electrical Safety Specification should be referenced to ensure proper planning and coordination. When the Electrical Work Tasks are required to be completed on an energized system, the Energized Electrical Work process described in the Electrical Safety Specification shall be implemented.

All non-electrical work tasks must be performed in a de-energized state when the Restricted Approach Boundary cannot be maintained. Work with the Electric Utility Company or the appropriate Contractor Leadership to ensure Safe Limits of Approach distances are maintained and isolation of the system is completed as required.

Safe Limits of Approach Boundaries (Table 1)			
Nominal System Voltage Range Phase-to-Phase	Limited Approach Boundary		Restricted Approach Boundary (includes Inadvertent Movement Adder)
	Exposed Movable Conductor	Exposed Fixed Circuit Part	
Less than 30 V (CAN)	Not Specified	Not Specified	Not Specified
Less than 50 V (US)	Not Specified	Not Specified	Not Specified
31 V - 150 V (CAN)	3.0 m (10 ft 0 in.)	1.0 m (3 ft 6 in.)	Avoid Contact
51 V - 150 V (US)	3.0 m (10 ft 0 in.)	1.0 m (3 ft 6 in.)	Avoid Contact
151 V - 750 V	3.0 m (10 ft 0 in.)	1.0 m (3 ft 6 in.)	0.3 m (1 ft 0 in.)
751 V - 15 kV	3.0 m (10 ft 0 in.)	1.5 m (5 ft 0 in.)	0.7 m (2 ft 2 in.)
15.1 kV - 36 kV	3.0 m (10 ft 0 in.)	1.8 m (6 ft 0 in.)	0.8 m (2 ft 9 in.)
36.1 kV - 46 kV	3.0 m (10 ft 0 in.)	2.5 m (8 ft 0 in.)	0.8 m (2 ft 9 in.)
46.1 kV - 72.5 kV	3.0 m (10 ft 0 in.)	2.5 m (8 ft 0 in.)	1.0 m (3 ft 6 in.)
72.6 kV - 121 kV	3.3 m (10 ft 8 in.)	2.5 m (8 ft 0 in.)	1.0 m (3 ft 6 in.)
138 kV - 145 kV	3.4 m (11 ft 0 in.)	3.0 m (10 ft 0 in.)	1.2 m (3 ft 10 in.)
161 kV - 169 kV	3.6 m (11 ft 8 in.)	3.6 m (11 ft 8 in.)	1.3 m (4 ft 3 in.)
230 kV - 242 kV	4.0 m (13 ft 0 in.)	4.0 m (13 ft 0 in.)	1.7 m (5 ft 8 in.)
345 kV - 362 kV	4.7 m (15 ft 4 in.)	4.7 m (15 ft 4 in.)	2.8 m (9 ft 2 in.)
500 kV - 550 kV	5.8 m (19 ft 0 in.)	5.8 m (19 ft 0 in.)	3.6 m (11 ft 8 in.)
765 kV - 800 kV	7.2 m (23 ft 9 in.)	7.2 m (23 ft 9 in.)	4.9 m (15 ft 11 in.)

3.3 OVERHEAD POWER LINES

Unqualified Workers shall not place themselves or operate equipment within the Safe Limit of Approach distance of overhead power lines or overhead systems in high voltage substations.

For work within the 6 m (20 ft.) Danger Zone of the Safe Limit of Approach boundary of overhead powerlines (see Figure 1.0) follow these requirements:

- Site orientations, pre-job meetings, and daily tailgate meetings which discuss:
 - assessed Hazards, SWPs and location(s) of the overhead power lines;
 - identified Hazards and any control
 - measures or precautions, in accordance with the Hazard Assessment;
- A Qualified Spotter shall be used when Workers and/or equipment encroach inside the Danger Zone and are in proximity to the Safe Limit of Approach distance.
- Delivery truck operators shall be cautioned about any overhead power lines present, and a Qualified Spotter shall assist with loading or unloading operations (as appropriate, other vehicle operators shall be similarly cautioned, e.g., high vehicles);
- When carrying ladders, or other metal conductive tools, equipment or materials they shall always be lower than shoulder height of the worker;
- Delivery or other vehicles that have emptied their material (e.g., dump trucks) shall not be permitted to leave the work location until the boom, lift or box is down and safely secured;
- Vehicles with loads higher than 4.5 m (14 ft.) shall follow specific procedures developed by the Company or the contractor to maintain safe working clearances when in transit below overhead power lines
- Warning cones/goal posts shall be used as visible indicators of the 3 m (10 ft.) Limit of Approach. A safe work area shall be established before work commences. (See Figure 2)
- If overhead power line voltages are unknown the Electric Utility Company shall determine the voltages and confirm the Safe Limit of Approach distance; until confirmed, a minimum of 10m (33 ft.) shall be maintained
- When isolating third party electricity crossings ensure that verification of isolation is carried out by an Electrical Utility Company Qualified Electrical Worker.

3.3.1 EQUIPMENT HAULING AND MOVING UNDER OVERHEAD POWER LINES

Before proceeding, the Contractor must determine the location, height and voltage of all overhead power lines that will be encountered when transporting, low bedding, moving, or operating any equipment around overhead power lines.

Never attempt to throw the binder straps over a load near overhead power lines as there is a potential to have an inadvertent contact with the energized overhead power line.

Ensure that the equipment being transported or operated, including any materials or trees being handled by a piece of equipment remains outside the Safe Limit of Approach and clear of all support guylines from the towers or poles.

Use a Qualified Spotter in areas where there is a likelihood of encroaching on the Safe Limit of Approach distances.

Telephone, and fiber optic cable lines do not have Safe Limit of Approach distances; however, the use of a Qualified Spotter may be required in areas where the equipment or material being handled may come in contact with the telephone or fiber optic cables.

Where it is determined that the height of equipment on a lowbed will be within the Safe Limit of Approach distance, the equipment must be either:

- Off loaded to travel under the overhead power lines and then re-loaded, or
- Disassembled sufficiently to travel under the overhead power lines and then re-assembled

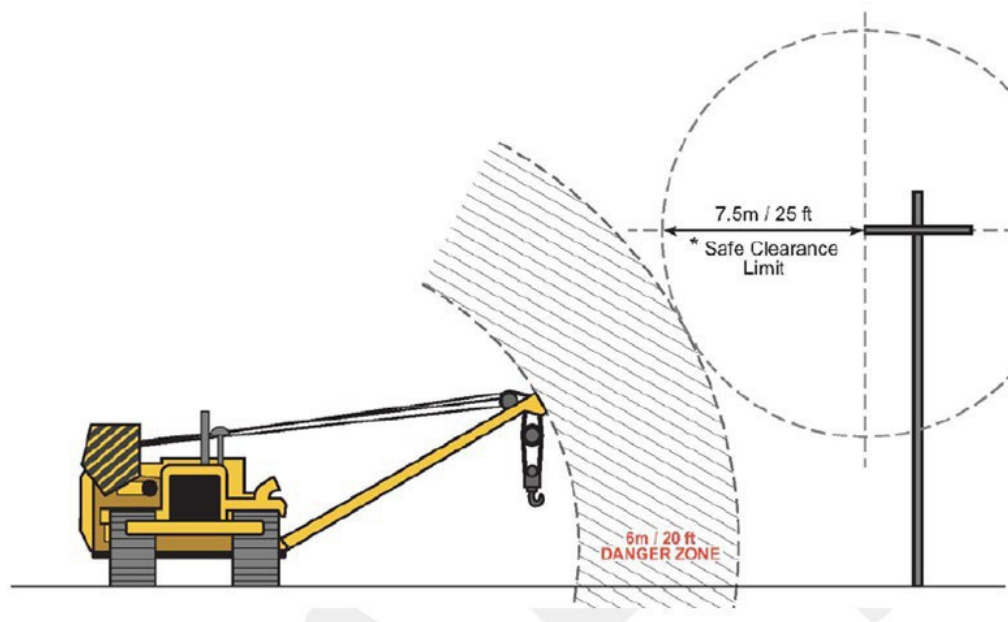

Figure 1 Example Danger Zone Between Equipment and Safe Limit of Approach Distance at known voltage of 300,000 – 350,000 Phase to Ground AC Voltage

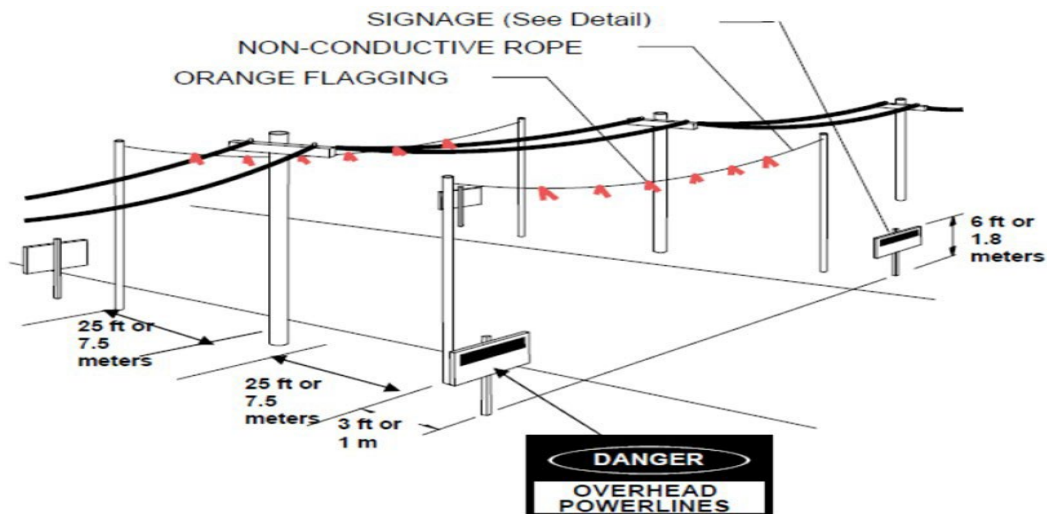

Figure 2 Crossing Overhead Power Lines

3.4 SIGNS & BARRIERS

Signs and barriers shall be installed by qualified workers prior to work commencing and shall remain in place until all work is completed. A documented inspection of the condition and effectiveness of the signs and barriers must further be completed by a qualified worker each day that work is conducted around the overhead power lines.

Signage will consist of standard design warning signs at least 24" X 24" (60 cm X 60 cm) in size.

Place warning signs on each side of the overhead power lines in plain view of those travelling in either direction under or adjacent to the lines. The recommended height for visibility is 6 ft. (1.8 m). Warning signs should ideally be placed approximately 3 ft. (1m) outside the applicable Safe Limit of Approach, but in any event may not be placed inside the Safe Limit of Approach.

Non-conductive guard poles ("goalposts") connected by non-conductive rope are to be placed no closer to the overhead power line than the applicable Safe Limit of Approach. Metal guard poles ("goalposts") or guy wires ARE NOT permitted. Non-conductive polypropylene rope is recommended, and visibility shall be supplemented by attaching short pieces of surveyors ribbon intermittently along its length.

The following alerting techniques are used to warn and protect all persons from hazards that could cause injury or damage to health due to electric shock, and arc flash:

- Safety signs, safety symbols, or accident prevention tags are used where necessary to warn workers about electrical hazards that may endanger them;

- An Electrical Work Zone will be established with barricading which can include the use of red “Danger” tape that is tagged or an Qualified Spotter;
- Barricades are used in conjunction with safety signs where it is necessary to prevent or limit individual access to work areas where individuals may be exposed to energized electrical conductors or circuit parts. Conductive barricades may not be used where they might cause an electrical contact hazard;
- If signs and barricades do not provide sufficient warning and protection from electrical hazards, a Qualified Spotter is stationed to warn and protect workers from entering the area.

3.5 BEST PRACTICES FOR HIGH RISK WORK

3.5.1 HEAVY MOBILE EQUIPMENT

All workers in the vicinity of heavy equipment working near overhead power lines shall be instructed to remain clear and out of contact with the frame of the equipment, hoisting lines or hoisted load.

Machinery and equipment will not be parked, fuelled or serviced under or within the Safe Limit of Approach distance of overhead power lines.

Dump trucks and track hoes must not travel with a raised box/upright booms within the Safe Limit of Approach distance for overhead power lines.

Independent truck drivers delivering materials to field locations shall be cautioned about overhead power lines before beginning work, and a properly trained on-site contract worker shall assist in the mechanical loading or off-loading operation. Vehicles that have emptied their material shall not leave the work location until the boom, lift, or box is down and safely secured.

3.5.2 TREE TRIMMING WORK

Overhead power lines shall be treated as energized and operating at high voltage until de-energized and verified zero voltage by the Qualified Electrical Worker or an Electric Utility Company Representative. A Utility Tree Trimmer shall be employed to remove trees and tree limbs in the vicinity of overhead power lines. Any part of the tree in contact with the overhead power line is to be considered energized at the full voltage of the overhead power line to which it is contacted.

A tree located within 1.5 times its height from Safe Limit of Approach distance will be felled mechanically or using mechanical assists only. No conventional hand felling is to take place within this perimeter. In circumstances where the terrain or conditions will not permit the use of a machine or machine assist, specialized fellers or certified Utility Tree Trimmers may be required. Specialized

felling techniques with the use of tree jacks and or lines or other specialized felling practices may be utilized.

3.5.3 VEHICLES WITH LOADS IN EXCESS OF A HEIGHT OF 4.15 M (14 FT.)

All vehicles with loads in excess of 4.15 meters (14 ft.) must use specific procedures to maintain safe working clearances when in transit below overhead power lines.

The specific procedures for moving loads in excess of 4.15 m (14 ft.) or via routes with lower overhead power line clearance heights are as follows:

- Prior to movement of any load in excess of 4.15 m (14 ft.), the Operator-in-Charge and/or the Electrical Utility Representative shall be notified of the equipment move. Travel on Provincial or State roads or highways shall be approved by the authority having jurisdiction;
- A Qualified Electrical Worker shall check the intended route to the next location before relocation;
- The new site shall be checked for overhead power lines and clearances;
- Overhead power lines and telephone or fiber optic cables shall be noted and extreme care used when travelling beneath the overhead power lines;
- The company moving the load or equipment shall provide a driver responsible for measuring each load and ensuring that each load is secured and transported in a safe manner;
- Overhead power line clearances shall be planned and safely measured by an Electric Utility Company Representative before high loads are transported.

If Safe Limit of Approach cannot be maintained, the job shall be shut down until a safe route can be established or the necessary mitigations or relocations have been completed to ensure that a safe working clearance has been achieved.

3.6 EMERGENCY RESPONSE PLAN

If an overhead power line falls or is contacted, the following requirements shall be observed:

1. Keep everyone at least 30m (100 ft.) away.
2. Follow all requirements of the Contractor's Emergency Response Program. Call the Operator-in-Charge and/or Electrical Utility Representative immediately.
3. Use red "Danger" tape and other barricades to ensure vehicle traffic cannot encroach on the fallen or low wires.
4. Do not attempt to move the wire(s).

5. Do not touch anything that is touching the wire(s).
6. Be alert to the presence of water or other conductors.
7. If an individual becomes energized, do not touch the individual or anything in contact with him or her. Rescue of the victim shall be undertaken when all hazards have been removed and verified by an Electric Utility Company Representative.
8. If energized conductors contact a vehicle, turn off the vehicle and remain in the vehicle and wait for rescue. If it becomes necessary to exit the vehicle due to smoke, fire, or other hazard, jump clear of the vehicle without touching it at the same time, maintain your balance, keep your feet together, and shuffle or bunny hop away from the vehicle 10 m (33 ft.) or more. Do not return to the vehicle or allow anyone else to return to the vehicle for any reason until the Electric Utility Company Representative has removed the overhead power line from the vehicle and has confirmed that the vehicle is no longer in contact with the overhead power lines.
9. Quarantine for 48 hours rubber-tired vehicles that have contacted energized lines (to address the hazard of tire pyrolysis).

3.7 AUTHORIZATION TO ACCESS SUBSTATION – NON ELECTRICAL WORKERS

Before granting access to a high voltage substation, the Qualified Electrical Worker High Voltage requires a Field Level Hazard Assessment (FLHA). The following general rules and policies apply with respect to access to the high voltage Substation:

- Prohibited material, tools and equipment shall not be taken into the Substation;
- Inventory all materials, PPE, tools and equipment that will be taken into the Substation and utilized during the work task that will be executed. Upon completion of the work task all materials, PPE, tools and equipment must be confirmed as removed from the Substation using the inventoried list;
- Under “Normal Operating Conditions” the minimum PPE required to be worn when entering high voltage substations includes daily FR workwear (pants/shirts and/or coveralls), hard hats, safety glasses with side shields, gloves, and protective footwear rated for electrical. An increased level of PPE may be required to be worn as determined for the work activity taking place in the substation and applicable arc flash hazard labels. PPE requirements for electrical work activities performed by qualified electrical workers are outlined in the Electrical Safety Specification.
- Qualified Electrical Workers High Voltage are authorized to enter the Substation. Any other worker shall be escorted and supervised at all times by the authorized Qualified Electrical Worker High Voltage;



Contractor Safety Specification

Safe Work Permit & Work
Authorization

Table of Contents

1.0	Definitions and Acronyms	2
2.0	Contractor Responsibilities	3
3.0	Specification Requirements	3
3.1	Safe Work Permit General Requirements.....	3
3.1.1	Work requiring Safe Work Permit.....	4
3.1.2	Exemptions for Long Term Operations Contractor Personnel.....	5
3.1.3	Duration.....	6
3.1.4	Mobile Crews without Company Inspector	6
3.1.5	Transfer of Responsibility	7
3.1.6	Document Copies.....	7
3.2	Suspension of Safe Work Permits	8
4.0	Appendix.....	9
4.1	Appendix A: Safe Work Permit.....	9

1.0 DEFINITIONS AND ACRONYMS

Enbridge—Enbridge, Inc. and Enbridge (U.S.) Inc., hereinafter will be referred to as “Company”.

Field Level Hazard Assessment (FLHA)—is a hazard assessment completed at the work face that assesses the hazards associated with the environmental conditions, nearby work, small tasks or hazards that could not be identified during the planning stages of jobs.

Hazard—Anything with sufficient energy, or potential energy, that can cause harm.

Hazardous Area— an area in which there is significant potential for a flammable or toxic atmosphere to be present or develop

Person in Charge - This is the employee or contractor responsible for the project or the scope of work who has current Permit Training.

Procedure - A step-by-step description of how to proceed, from start to finish, in performing a task properly.

Qualified- one who, by possession of a recognized degree, certificate, or professional standing, or who by knowledge, training and experience, has successfully demonstrated their ability to solve or resolve problems relating to the subject matter, the work, or the project

Restricted Area—any area in which there is limited potential for a flammable or toxic atmosphere to develop.

Safe Work Permit (SWP)—Agreement between the Permit Issuer and Permit Receiver on the hazards associated with the job have been identified and controlled.

Safe Work Permit Issuer —a qualified person that has been trained in the Safe Work Permit and is competent in understanding the hazards associated with the area or facility in which work is to take place.

Safe Work Permit Receiver—Person accepting responsibility for the work being conducted.

Site Plot Plan - Site-specific drawing that shows Hazardous and Restricted Areas, primary evacuation site, secondary evacuation site, helicopter landing areas and the location of safety facilities and equipment (e.g., evacuation alarms, wind socks, fire extinguishers and first aid stations).

Work Authorization (WA)—The Work Authorization process provides a formal process to acknowledge an extended work plan for Contractors on a Company site and documents who (and how) Safe Work Permitting duties will be managed during that work.

Work Authorization Issuer —a qualified person that has been trained in the SWP & WA and is competent in understanding the hazards associated with the area or facility in which work is to take place.

2.0 CONTRACTOR RESPONSIBILITIES

Safe Work Permit Receiver

The SWP Receiver shall be familiar with the SWP process, the work area, equipment, and understand the work to be carried out. This can occur as part of the worksite visit.

The SWP Receiver is responsible for:

- Reviewing and agreeing to the conditions of the SWP;
- Communicating the SWP requirements to all Workers involved in the work;
- Ensuring the SWP requirements are fulfilled by all workers during the work;
- Keeping a copy of the SWP (white/top copy) readily available at the work location;
- Suspending work as required;
- Having suspended work revalidated by SWP Issuer before recommencing work;
- Ensuring Field Level Hazard Assessments (FLHA) are completed and reviewed for the work and that workers involved in the work participated in the FLHA;
- Informing SWP Issuer of a transfer of responsibility to determine if a new SWP is required;
- Returning the equipment, process or area to a safe condition before returning the SWP and FLHAs back to the SWP Issuer; and
- Ensuring SWP is completed and signed-off when returned to the SWP Issuer.

3.0 SPECIFICATION REQUIREMENTS

3.1 SAFE WORK PERMIT GENERAL REQUIREMENTS

- SWP may be issued verbally, electronically or in person;
- SWP Issuers cannot issue permits to themselves, in instances of remote work, the SWP can be issued verbally or electronically:
 - Remote workers can capture verbal requirements on their own copy of SWP, logging date and time of approval by Issuer on the SWP. Electronic follow up for verification is preferred.
- SWP cannot be issued directly to a subcontractor;
- As practical based on job scope and location, the SWP Issuer shall visit the worksite with the SWP Receiver to identify Hazards of the work location;
- All workers shall be made aware of and adhere to the conditions of the SWP;

- The working group shall complete an FLHA prior to commencing work;
- Only the work stipulated on the SWP in the identified location is to be performed;
- When initial atmospheric monitoring is required, it shall be conducted and documented on the SWP before work can begin. Also:
 - Subsequent atmospheric monitoring shall be completed as indicated on the SWP, use the *Atmospheric Monitoring Specification* for guidance on frequency of testing; and
 - Initial atmospheric monitoring is an Company responsibility and shall be completed or witnessed by an operations representative, Company inspector or another Company representative. This initial testing shall be documented on the SWP. Subsequent atmospheric monitoring can be performed by the person responsible for the work and may be verified by the Company.
- Company inspectors issuing SWPs shall receive a valid Work Authorization prior to issuing any SWPs.

3.1.1 WORK REQUIRING SAFE WORK PERMIT

The following types of work require an SWP:

- Work where the shutdown and/or isolation of equipment and/or processes are required to complete the work;
- Work on electrical equipment and circuits with voltages >750V (CAN) or 600V (USA);
- Work upstream of the 480V main breaker;
- Looking for and work on pipeline anomalies;
- Work on leaks or leak sites;
- Welding on mainline or station piping;
- Work involving contractors (apart from exemptions managed as per below);
- Hot work in Hazardous or Restricted Areas with the following exceptions:
 - Driving vehicles through Restricted Areas
 - Breaking low voltage connections in Restricted Areas
 - Work that involves using low voltage equipment such as voltmeters, laser alignment and hand-held vibration meters, analyzers, cellular telephones or cameras (continually monitor the work area for combustible vapors in this case).
- Work on or around an open system with the following exceptions:

- Flushing units;
- Gauging;
- Sampling; and
- Opening depressurized lines less than or equal to 2 inches in diameter.

The following contractors may be exempt from safe work permitting:

- Driving vehicles through non-Restricted Areas;
- Delivery and service personnel (e.g. delivery and supply vendors, equipment service personnel, telephone, computer, etc.); and
- Long term operations contractor personnel.

Contractor exemptions shall be approved by the person responsible for the location, and work shall be monitored by a Company operations employee or designate.

3.1.2 EXEMPTIONS FOR LONG TERM OPERATIONS CONTRACTOR PERSONNEL

Long term operations contractor personnel may be given an exemption for a SWP for up to one year if all the following requirements are met. They:

- Are approved by the operations employee responsible for the contractor and operations management or the person responsible for the work location(s);
- Have been used on a frequent basis or have worked extended periods of time with the Company;
- Clearly demonstrate their knowledge and understanding of safe work practices and technical Procedures applicable to their line of work;
- Have been given a thorough safety orientation;
- Participate in Company safety meetings as determined by the person responsible for the site;
- Maintain daily communication with Company operations representative or designate; and
- Are monitored by the Company operations representative or designate responsible for the location and work.

The Company operations representative responsible for a contractor shall document an exemption and provide copies to the contractor, operations management, and employee(s) responsible for the location(s).

Documentation shall include:

- A brief description of the services being provided (e.g., welding, electrical, mechanical labor, inspection services, cathodic protection system maintenance);
- Justification for the exemption;
- Names of contractor and subcontractor Personnel;
- Special requirements;
- Locations for which the exemption applies (e.g., station, ROW milepost boundaries);
- Period of time for which the exemption applies; and
- Names of Company employees who approved the exemption.

Long term operations contractor personnel provided an exemption shall comply with all stipulated requirements as listed in 3.1.1 and 3.1.2.

3.1.3 DURATION

- A SWP is only valid for the time stated on the permit to a maximum of 12 hours except for mobile crews without a Company Inspector;
- A SWP may be extended an additional 12 hours to a maximum of 24 hours provided that:
 - The work is continuous;
 - The workers do not exceed the maximum allowable hours worked;
 - A review of the SWP indicates it is still valid;
 - All workers understand the requirements of the SWP and meet FLHA requirements;
 - An extension is identified and authorized on the SWP as required; and
 - Transfer of responsibility is completed as required.

3.1.4 MOBILE CREWS WITHOUT COMPANY INSPECTOR

Mobile crews are contractor crews that are required to perform a specific job function over a specified span of ROW or at multiple facilities without direct oversight by a Company representative (e.g. pig trackers, cathodic protection, surveyors, vegetation control),

Mobile crews may be issued a SWP at the originating location of the work for the duration of the job provided that:

- A frequency of contact is established and implemented (this frequency of contact is the minimum requirement of how often the SWP Receiver shall contact the SWP Issuer. The SWP Receiver documents this communication under the “Frequency of Contact with Issuer or Designate” section on the SWP; additional documentation may be attached to the SWP should space not be available); and
- A new FLHA is completed at the beginning of each day or shift and updated as required.

3.1.5 TRANSFER OF RESPONSIBILITY

Any changes to the responsible parties during the course of the work shall be documented on the SWP as a transfer of responsibility: A SWP can only be transferred once and require the following:

- The SWP Issuer, Receiver and all workers affected shall be made aware of any transfers of responsibilities.
- The SWP Issuer reserves the right to suspend the current SWP and require a new SWP to be issued.

3.1.6 DOCUMENT COPIES

- White/top copy: SWP Receiver keeps or posts this copy at the work location while the permit is valid. SWP Receiver returns this copy, FLHA and other pertinent documentation to the SWP Issuer when the SWP time period has expired.

If an Incident occurs during the course of work, the white copy of the SWP along with all other documentation shall be forwarded to the person responsible for conducting the incident investigation and will be retained as identified in the requirements for incident investigation documentation.

- Yellow copy: SWP Issuer posts this copy at the worksite or similar site locality to identify work activities occurring at the site. Discard after the white copy is returned or give to the SWP Receiver if requested.

In compliance with *Company Records Management Policy* and *Records Retention Schedule*, Company Employees must retain all SWPs and any related documents or records. Contractors shall have a records retention policy to ensure that all documents or records used, prepared or produced by the contractor in the performance of the work are maintained by the contractor for durations of time that are not less than the limitation periods prescribed in the applicable statutes of limitations or limitation of actions legislation in force in the jurisdictions the contractor operates.

3.2 SUSPENSION OF SAFE WORK PERMITS

The SWP become suspended and work shall stop under any of the following conditions:

- Site emergencies;
- Scope of work changes; and/or
- Requested to stop work.

The time of suspension shall be documented on the WA or SWP, as the case may be, by the Receiver. Suspended permits shall be revalidated, at a minimum, verbally by the Issuer and documented on the WA or SWP before work can resume.

Suspensions due to scope of work changes cannot be revalidated. A new WA and/or SWP is required.

4.0 APPENDIX

4.1 APPENDIX A: SAFE WORK PERMIT

Safe Work Permit



Part A: Work Details																																																																																												
Work Type: <input type="checkbox"/> Hot <input type="checkbox"/> Cold	Emergency Contact: _____ (Name) (Ph #)	Date/Time Issued: _____ MM/DD/YY _____ Time	Date/Time Expired: _____ MM/DD/YY _____ Time	Permit Extended (New entry): _____ MM/DD/YY _____ Time	Extension Authorized by: _____ Permit Issuer / Designate	Suspended at: _____ MM/DD/YY _____ Time Permit Receiver Initials	Rescind date at: _____ MM/DD/YY _____ Time Permit Issuer Initials	Work Authorization Form # (if applicable)	Frequency of Contact with Permit Issuer or Designate: <input type="checkbox"/> Not applicable <input type="checkbox"/> Daily <input type="checkbox"/> Weekly <input type="checkbox"/> Other: _____	<table border="1"> <tr><td>Date</td><td></td><td></td><td></td><td></td><td></td><td></td><td></td><td></td><td></td></tr> <tr><td>Initial</td><td></td><td></td><td></td><td></td><td></td><td></td><td></td><td></td><td></td></tr> <tr><td>Date</td><td></td><td></td><td></td><td></td><td></td><td></td><td></td><td></td><td></td></tr> <tr><td>Initial</td><td></td><td></td><td></td><td></td><td></td><td></td><td></td><td></td><td></td></tr> </table>	Date										Initial										Date										Initial																																																			
Date																																																																																												
Initial																																																																																												
Date																																																																																												
Initial																																																																																												
Work Environment: <input type="checkbox"/> Hazardous <input type="checkbox"/> Restricted <input type="checkbox"/> Unrestricted	Alternate: _____ (Name) (Ph #)	Fire/Police/Ambulance: _____	Emergency Assembly Area: _____	Location: Physical address, geographical description						Work Scope/Description																																																																																		
Part B: Preplanning Documentation					Part C: Special Precautions and Considerations																																																																																							
Contractor hazard assessment (e.g. SW) required?	Yes	No	N/A	Is it necessary to notify other departments?	Yes	No	N/A	Are barriers, flagging, or warning signs required?	Yes	No	N/A																																																																																	
Applicable procedures have been reviewed?				Is bonding or grounding required?				All workers have current required orientation?																																																																																				
Energy Isolation Form required?				Has containment been provided for any liquid release?				Is spark containment/control required?																																																																																				
Electrical Equipment Isolation and Work Clearance Form required?				Facility Emergency Shutdown? Yes considered?				Have precautions been taken for X-ray/radiation work?																																																																																				
Confined Space Permit required? Permit #				Special PPE requirements: All yes, any below				All workers have applicable training?																																																																																				
Critical Lift Plan required?				Site specific hazards identified and discussed?				Is a field level hazard assessment required?																																																																																				
Serious Lift Plan required?				Other needed: _____				Additional preplanning requirements from Permit Issuer: Use this space to indicate simultaneous operations that may affect the working group, etc. (e.g. truck fill assembly, pig flow, bring forward) or other special company instructions																																																																																				
Fall Protection Plan required?				Part D: Area Atmospheric Testing																																																																																								
Excavation Checklist required?				Is gas testing/monitoring required? <input type="checkbox"/> No <input type="checkbox"/> Yes (<input type="checkbox"/> Continuous)	<table border="1"> <thead> <tr> <th></th> <th>Initial Result</th> <th>2nd Result</th> <th>3rd Result</th> <th>4th Result</th> <th>5th Result</th> <th>6th Result</th> <th>7th Result</th> <th>8th Result</th> </tr> </thead> <tbody> <tr> <td>LEL - Flammable Vapors: LEL (0-10%)</td> <td></td><td></td><td></td><td></td><td></td><td></td><td></td><td></td> </tr> <tr> <td>Oxygen: 0.19.5-23% (CAN) 23.5% (US)</td> <td></td><td></td><td></td><td></td><td></td><td></td><td></td><td></td> </tr> <tr> <td>Hydrogen Sulphide: H₂S (<10ppm)</td> <td></td><td></td><td></td><td></td><td></td><td></td><td></td><td></td> </tr> <tr> <td>Carbon Monoxide: CO (<25ppm)</td> <td></td><td></td><td></td><td></td><td></td><td></td><td></td><td></td> </tr> <tr> <td>Benzene (<0.5ppm)</td> <td></td><td></td><td></td><td></td><td></td><td></td><td></td><td></td> </tr> <tr> <td>Other</td> <td></td><td></td><td></td><td></td><td></td><td></td><td></td><td></td> </tr> <tr> <td>Time of Test</td> <td></td><td></td><td></td><td></td><td></td><td></td><td></td><td></td> </tr> <tr> <td>Tester's Name (initial must be completed by Enbridge Rep)</td> <td></td><td></td><td></td><td></td><td></td><td></td><td></td><td></td> </tr> </tbody> </table>								Initial Result	2 nd Result	3 rd Result	4 th Result	5 th Result	6 th Result	7 th Result	8 th Result	LEL - Flammable Vapors: LEL (0-10%)									Oxygen: 0.19.5-23% (CAN) 23.5% (US)									Hydrogen Sulphide: H ₂ S (<10ppm)									Carbon Monoxide: CO (<25ppm)									Benzene (<0.5ppm)									Other									Time of Test									Tester's Name (initial must be completed by Enbridge Rep)								
	Initial Result	2 nd Result	3 rd Result	4 th Result	5 th Result	6 th Result	7 th Result	8 th Result																																																																																				
LEL - Flammable Vapors: LEL (0-10%)																																																																																												
Oxygen: 0.19.5-23% (CAN) 23.5% (US)																																																																																												
Hydrogen Sulphide: H ₂ S (<10ppm)																																																																																												
Carbon Monoxide: CO (<25ppm)																																																																																												
Benzene (<0.5ppm)																																																																																												
Other																																																																																												
Time of Test																																																																																												
Tester's Name (initial must be completed by Enbridge Rep)																																																																																												
Ground Disturbance Permit required?				Part E: Permit Approval																																																																																								
Open System Job Planning Template Required?				Work cannot begin until the required approvals are on this document and a field level hazard assessment has been completed by the work group. All persons performing this work must comply with Enbridge safety policies and government regulations. Work must stop immediately should conditions change/new hazards appear or an emergency occur on the site.																																																																																								
Permit Issuer				Permit Receiver																																																																																								
Name: _____				Name: _____ Company: _____																																																																																								
Signature: _____ Ph #: _____				Signature: _____ Ph #: _____																																																																																								
Transfer of Responsibility				Transfer of Responsibility																																																																																								
Name: _____ Date/Time: _____				Name: _____ Date/Time: _____																																																																																								
Signature: _____ Ph #: _____				Signature: _____ Ph #: _____																																																																																								
Part F: Permit Returned																																																																																												
Returned by	Received by	Date/Time Returned	MM/DD/YY	Time																																																																																								
<input type="checkbox"/> FJHA(s) returned for the work	Comments: (e.g. work complete, ongoing, incomplete, area cleaned up)																																																																																											

Distribution: White - Permit Receiver, Gold - Permit Issuer

Retain white copy for 2 years

VERSION 5.3 (Revised March, 2019)

<END OF DOCUMENT>



Contractor Safety Specification

Safety Meeting, Tailgate
and Toolbox Talks

Table of Contents

1.0	Definitions & Acronyms.....	2
2.0	Contractor Responsibilities	2
3.0	Specification Requirements	3
3.1	Safety Meeting Minimum Requirements	3
3.2	Prejob Meetings/Tailgate Meetings Minimum Requirements	3
3.3	Toolbox Talk Minimum Requirements.....	4
3.4	Attendance Expectations	5

1.0 DEFINITIONS & ACRONYMS

Call to Action—A call to action from Leadership is direction to the frontline based on trended data provided on the department or business area. An example would be job observation trends showing increasing at-risk behaviour due to gas monitors that have not been bump tested prior to being worn. The call to action would be ensuring that all gas monitors are bumped prior to use.

Enbridge—Enbridge, Inc. and Enbridge (U.S.) Inc., hereinafter will be referred to as “Company”.

Tailgate Meeting—A term used interchangeably with Pre-Job Meeting. A meeting completed on a daily basis at the start of each shift to review the daily work plan or safe work permit and the associated health & safety issues associated. In some cases a Tailgate or Prejob meeting will be completed prior to commencing with a high risk task.

Toolbox Talk—An informal meeting that focuses on safety topics related to a specific job, hazard, safe work practice or learning intended to facilitate health & safety discussions on the worksite and improve organizational safety culture.

2.0 CONTRACTOR RESPONSIBILITIES

Contractor shall:

- Provision sufficient resources to effectively implement this specification;
- Responsible to ensure the scheduling of safety meetings;
- Ensure that meeting minutes are completed, logged and shared with workers and contractors on a timely basis;
- Regularly review safety meeting action logs to ensure that action items are logged, tracked, closed, and communicated in a timely manner;
- Conduct toolbox talks with workers on a regular basis;
- Provide positive feedback and support to workers who provide safety concerns at safety meetings and tool box talks;
- Engage frontline workers during tool box talks through questioning and solicitation for feedback on the topic discussed; and
- Monitor and assess ‘fit for duty’ of team during tool box talks.
- Be knowledgeable of the requirements and expectations of this specification;
- Prepare and facilitate safety meeting if requested;
- Bring forward safety concerns from the worksite to be addressed at the safety meeting or tool box talks;
- Prepare and present safety moment or other topic at the safety meeting if requested; and

- Engage in conversation and discussions within safety meeting and toolbox talks as appropriate.

3.0 SPECIFICATION REQUIREMENTS

Contractors and sub-contractors shall attend regularly scheduled safety meeting to discuss current and relevant topics related to environment, health and safety.

Pre-job meetings/tailgates are complete prior to the start of a shift or high risk task.

Toolbox talks will be completed on a regular basis as determined necessary by the Contractor or when directed by the project.

3.1 SAFETY MEETING MINIMUM REQUIREMENTS

Each safety meeting must meet the minimum requirements:

- Safety Moment;
- Safety concerns action log review and new business;
- Review area specific trending;
 - Incident reviews and event lessons learned;
 - Leading and lagging metric trends;
 - Call to action from leadership.
- Safety topic presentations; and
- Other relevant agenda topics.

It is Contractor Management accountability to ensure that all safety concerns are logged and tracked in a manner that is directly visible to workers during the safety meeting and accessible to the worker thereafter. It is also Contractor Management accountability to ensure that the concerns are addressed in a timely manner.

3.2 PREJOB MEETINGS/TAILGATE MEETINGS MINIMUM REQUIREMENTS

Prejob Meetings

The following types of work shall have a specific pre-job meeting with workers involved in the task to discuss the specific hazards associated with the job:

- High voltage electrical work;
- Serious and critical lifts;
- Confined space entry;
- Ground disturbance;

- Work around overhead power lines;
- Open systems work;
- Pigging;
- Tie-ins; and
- Specific one-off jobs that are hazardous.

Pre-job meetings must include all work groups involved in job planning and job execution. For example, if Operations has conducted the lock out for a PLM job, Operations must attend the pre-job meeting to review the lock out.

Tailgate Meetings

On a daily basis at the start of each shift, a “tailgate” safety meeting must be conducted to review the daily work permit and health and safety issues associated with the day’s work, or in some cases, prior to a specific high-risk task.

Contractors may choose to use the following questions to engage conversation during the Pre-job/tailgate meetings:

1. What are the highest risk tasks within the job or permits for today?
2. What could go wrong while completing these tasks?
3. How are we going to manage these hazards?
4. What event would have to happen during the completion of these tasks to trigger a stoppage of work?
5. What were the learnings and pertinent hand over information from last shift or the last time this task was performed?
6. Solicit any outstanding safety concerns from the team.

3.3 TOOLBOX TALK MINIMUM REQUIREMENTS

A toolbox talk is an informal safety meeting that focuses on safety topics related to the specific job, such as workplace hazards and safe work practices. Meetings are normally short in duration and are generally conducted at the job site prior to the start of a shift, during a coffee break, prior to lunch ending or as directed by Contractor Management. It is an effective method to increase engagement between Contractor Management and their reports, refresh a worker’s safety knowledge, cover last minute safety checks and facilitate the exchange of information between new and experienced workers. Toolbox Talks are also intended to facilitate health and safety discussions on the job site, promote safety awareness and learning as well as improve an organization’s safety culture overall.

Examples of material that could be covered within a toolbox talk includes:

- A recently completed field level hazard assessment by the team providing positive feedback and continual improvement opportunities;
- An example of an excellent safety observation that was recently submitted by a member of the crew;
- Current safety observation trending results, where available;
- An applicable external safety alert;
- Discussion on a recent emergency response exercise that was completed by the team;
- Review of an executive safety message; and
- Review an existing Toolbox Talk on a specific safety topic

Whichever toolbox talk format is chosen, there are several mandatory elements which must be present:

- Tool box talks discussions or information provided must be safety related;
- The information provided is timely and relevant to the audience and the work they do; and
- There is a call to action on the information provided for the workers to institute within the upcoming work.

3.4 ATTENDANCE EXPECTATIONS

Safety meeting, Pre-Job/Tailgate and Toolbox Talk attendance requirements for contractors is mandatory unless specific direction is provided by the Project.

<END OF DOCUMENT>



Contractor Safety Specification

Safety Observation



Table of Contents

1.0	Definitions & Acronyms	2
2.0	Roles & Responsibilities	2
3.0	Specification Requirements	2
3.1	Types of Safety Observations	2
3.2	Safety Observation Considerations	2
3.3	Action Plan	3
3.4	Quality Assessments	3
3.5	Tracking/ Trending Methods	3

1.0 DEFINITIONS & ACRONYMS

Behavior—an observable action.

Enbridge—Enbridge, Inc. and Enbridge (U.S.) Inc., hereinafter will be referred to as “Company”.

Imminent Danger—any conditions or practices in which danger exists that could reasonably be expected to cause death or serious physical harm.

Safety Observation—an observation of safe or at-risk behavior, which includes an interaction between the observer and the observed person to reinforce or correct the observed behavior. The observation must document both interaction and the reinforcement or correction of the observed behavior as well as the agreement to improve moving forward. A safety observation is not the documentation of a hazardous condition (identifying a trip hazard or a missing guard on a tool— for more information see the *Inspection Specification*).

2.0 ROLES & RESPONSIBILITIES

Contractors shall:

- Demonstrate program commitment and active participation,
- Review safety observations completed by direct reports,
- Complete safety observation process by ensuring data entry into EnCompass,
- Ensure that the completed observation meets the definition of a quality safety observation as defined herein, and
- Ensure relevant learnings and resulting trends from safety observations are reviewed and shared with team.

3.0 SPECIFICATION REQUIREMENTS

3.1 TYPES OF SAFETY OBSERVATIONS:

Planned—Scheduled safety observations to review worker’s behavior and adherence to procedures, critical task(s) and/or work that is known to be occurring. These can result in both safe and/or at-risk behavior observations.

Ad hoc—Safety observations that are observed and acted upon spontaneously. They do not involve scheduling and can result in both safe and/or at-risk behavior observations.

Both types of safety observations shall be completed in accordance to the Safety Observation Process created by the Contractor.

3.2 SAFETY OBSERVATION CONSIDERATIONS:

1. Observe: Observations should focus on Behaviors (safe and at-risk behaviors).

2. Comment: Speak to the observed individual and comment on what was observed.
3. Discuss: A two-way conversation about the safety observation with the observed individual is the most important part of the observation.
4. Come to an agreement:
 - a. Safe observed behavior: reinforce the observed behavior and commitment to continue to work safely.
 - b. At-risk observed behavior: encourage the person to stop performing the at-risk behavior, discuss why it's at-risk. Obtain a commitment from the observed to improve their safety now and in the future.
5. Additional discussion: ask for and discuss other safety improvement opportunities.
6. Acknowledge: remember to thank the observed worker and document the conversation on a safety observation card.

*Note: Stop and intervene on work whenever imminent danger is present or there is potential for incident.

3.3 ACTION PLAN:

If an at-risk behavior cannot be corrected with immediate action, an action item must be created and tracked through to completion.

3.4 QUALITY ASSESSMENTS:

To promote continuous improvement of our safety observations, the Company has created a tool to help quantify the quality of safety observations completed. This tool will set the criteria to allow reviewers to assess the completed safety observation and highlight opportunities for improvement.

3.5 TRACKING/ TRENDING METHODS:

Metrics for the safety observation program should be quantified, tracked, and trended using the appropriate Contractor developed tool.

Information derived from tracking and trending shall be shared with the workforce as applicable. See the Safety Meetings and Toolbox Talk Specification for more information.

<END OF DOCUMENT>



Contractor Safety Specification

Safety Orientation and
Visitor Access



Table of Contents

1.0	Definitions & Acronyms.....	2
2.0	Contractor Responsibilities	2
3.0	Specification Requirements	2
3.1	Contractors & Subcontractors	3
3.2	Visitors	3
4.0	Training Requirements.....	4
5.0	References.....	4

1.0 DEFINITIONS & ACRONYMS

Enbridge- Enbridge, Inc. and Enbridge (U.S.) Inc., hereinafter will be referred to as “Company”.

Visitors—defined as any Company or non-Company individual that is not performing any assigned work activity on a Company worksite (i.e. ROW, facility, construction site). An example of a visitor is any individual who is completing a supervised tour of a Company worksite.

Worksite—the entire work area required for the work, including all Company property, right of way, temporary working space and all right of way storage areas as required by the Company.

2.0 CONTRACTOR RESPONSIBILITIES

Contractors, subcontractors and visitors shall:

- Be responsible for participating in and completing the necessary orientations for the Company locations they access and perform work within.

3.0 SPECIFICATION REQUIREMENTS

The Company endorses a two-part safety orientation to contractors. Prior to performing work at a Company location all contractor and subcontractor personnel shall receive the Company safety orientation and site specific orientation.

The Company safety orientation is available as an online self-guided ecourse. The Company safety orientation is both knowledge and risk-based and includes an introduction to the expectations of the Company as well as an explanation of why these expectations are important for the safety of our employees, contractors, public and environment.

The site specific (regional or project) orientation is delivered at the work location and provides insight into how to execute the expectations outlined in the Company safety orientation.

The Company safety orientation covers topics that include, but are not limited to:

- Health & Safety Policy;
- Environmental Policy;
- Personal protective equipment requirements, as applicable to the work environment;
- Incident reporting procedures;
- Driver training requirements;
- Additional policies:
 - Alcohol and Drug Free Workplace Policy;
 - Respectful Workplace Policy;

- Cell Phone and Mobile Radio Use while Operating a Motor Vehicle Policy;
- Driver's License and Driving Record Policy;
- Company Security and Photo Identification Policies;
- Right to refuse any work deemed to be unsafe.

The Site Specific Orientation covers topics that include, but are not limited to:

- Expectations for personal protective equipment;
- Evacuation alarms (i.e. sirens or horns);
- Location of emergency exit gates, wind socks, assembly areas, smoking areas and first aid stations;
- Evacuation and emergency procedures (including muster points);
- Sign-in/out procedures and security requirements;
- Permit requirements;
- Hazardous & restricted areas;
- Review of site safety plot plan;
- Designated roads and parking areas;
- Vehicle seatbelt use and posted speed limits;
- Reporting unsafe acts/conditions, injuries or property damage;
- Site specific activity or work-site hazards; and
- Restrictions pertaining to communication devices and cameras with flashes.

3.1 CONTRACTORS & SUBCONTRACTORS

The Company safety orientation is an annual requirement for contractors hired by Operations and Projects in both Canada and the United States. The Company safety orientation is a prerequisite for participating in a site-specific orientation. Site-specific orientation is a requirement prior to commencing work at a specific Company region or project location.

3.2 VISITORS

Visitors shall be at the Worksite only for work-specific purposes and will be required to:

- Attend the site specific orientation; and
- Be escorted for the duration of their visit.

4.0 TRAINING REQUIREMENTS

Contractors and subcontractors shall be trained:

- According to the applicable Company requirements in the applicable safety specification their work is related to;
- In the operation of vehicles, tools and equipment that they are required to use;
- In the safe work practices and hazards associated with the vehicles, tools and equipment they use;
- To safely carry out the tasks or work activities associated with their job function; and
- Beyond the requirements set out in this Specification when required by applicable legislation.

Contractors and subcontractors will follow their internal training requirements as outlined within their contract.

- Contractors shall be able to provide proof of training of its Contractor Personnel to a Company Representative upon request.

5.0 REFERENCES

Occupational Safety & Health Administration – Regulations (Standards – 29 CFR)

Canada Labour Code PART II - Canada Occupational Health and Safety Regulations

Occupational Health and Safety Training - CAN/CSA-Z1001-13

<END OF DOCUMENT>

Uncontrolled Copy if Printed or Downloaded



Contractor Safety Specification

Storage and
Transportation of
Hazardous Materials

Table of Contents

1.0	Definitions & Acronyms.....	2
2.0	Contractor Responsibilities	3
3.0	Specification Requirements	3
3.1	Hazardous Materials Storage.....	3
3.1.1	Storage Cabinets.....	3
3.1.2	Storage in Buildings	4
3.1.3	Spill Containment	4
3.1.4	Transporting Hazardous Materials	5
3.1.5	Transportation of Fuel or Liquid Hazardous Materials.....	5
3.1.6	Required Documentation.....	5
3.2	Compressed Gas Cylinders	6
3.2.1	Compressed Gas Cylinder Storage.....	7
3.2.2	Compressed Gas Cylinder Transport.....	8
3.2.3	Aerosol Cans.....	8
3.3	Propane Bottles and Accessories	8
3.4	Leaks and Spills.....	9
4.0	References.....	9

1.0 DEFINITIONS & ACRONYMS

Combustible Liquids - flashpoint at or above 37.8°C (100°F) and below 93.3°C (200°F). Combustible Liquids have the ability to burn at temperatures that are usually above working temperatures.

Enbridge—Enbridge, Inc. and Enbridge (U.S.) Inc., hereinafter will be referred to as “Company”.

Flammable Liquids (Canada) - flashpoint below 37.8°C (100°F).

Flammable Liquids (US) - flashpoint at or below 93 °C (199.4 °F) divided into four categories:

Category 1 shall include liquids having flashpoints below 23 °C (73.4 °F) and having a boiling point at or below 35 °C (95 °F)

Category 2 shall include liquids having flashpoints below 23 °C (73.4 °F) and having a boiling point above 95 °F (35 °C).

Category 3 shall include liquids having flashpoints at or above 23 °C (73.4 °F) and at or below 60 °C (140 °F). When a Category 3 liquid with a flashpoint at or above 37.8 °C (100 °F) is heated for use to within 16.7 °C (30 °F) of its flashpoint, it shall be handled in accordance with the requirements for a Category 3 liquid with a flashpoint below 37.8 °C (100 °F).

Category 4 shall include liquids having flashpoints above 60 °C (140 °F) and at or below 93 °C (199.4 °F). When a Category 4 flammable liquid is heated for use to within 16.7 °C (30 °F) of its flashpoint, it shall be handled in accordance with the requirements for a Category 3 liquid with a flashpoint at or above 37.8 °C (100 °F).

GHS – Globally Harmonization System

Hazardous Materials - A material, other than hazardous waste, that because of its quantity, concentration and physical or chemical characteristics, either individually or in combination with other substances is or poses a threat to the environment, humans or other living organisms.

HAZCOM – Hazard Communication

HAZMAT – Hazardous Materials

SDS – Safety Data Sheets are summary documents that provide information about the hazards of a product and advice about safety precautions. SDSs are usually written by the manufacturer or supplier of the product.

TDG – Transportation of Dangerous Goods

WHMIS – Workplace Hazardous Material Information System

2.0 CONTRACTOR RESPONSIBILITIES

Contractor shall:

- Ensure that direct reports are trained accordingly
- Ensure that direct reports are informed about the hazardous materials and compressed gases that they are using
- Use appropriate controls when working with hazardous materials and compressed gases
- Carry proof of certification (HAZMAT/ TDG) at all times while performing transportation of hazardous materials work
- Complete the appropriate level of training based on applicable legislation. (e.g., shippers/drivers)

3.0 SPECIFICATION REQUIREMENTS

3.1 HAZARDOUS MATERIALS STORAGE

Hazardous materials shall:

- Be stored indoors whenever possible;
- Be stored away from equipment and vehicle routes;
- Be stored away from moisture and excessive heat;
- Be stored on an impervious surface with containment capabilities (e.g., dikes, curbs); or if not available, on an impermeable containment structure (e.g., tray, containment pallet, tote);
- Be stored a minimum distance of 100 m [CAN] or 100 ft. [USA] from any body of water;
- Not be stored on ice; and
- Be separated from incompatible materials.

Flammable liquids shall be stored in the original container or in other approved portable containers. All containers shall be inspected regularly to ensure containment.

3.1.1 STORAGE CABINETS

The total maximum quantity of flammable liquids and combustible liquids stored indoors, outside of a storage cabinet shall not exceed:

- In Canada—600 L in closed containers, of which not more than 100 L may be flammable liquids; and

- In US—25 gallons of category 1 flammable Liquids, 120 gallons of category 2,3 or 4 Flammable Liquids in containers, or 660 gallons of Category 2, 3, or 4 Flammable Liquids in a single portable tank.

The total maximum quantity inside a storage cabinet shall not exceed:

- In Canada – 500 L, of which not more than 250 L may be Flammable Liquids (Canada);
- In US - 60 gallons of Category 1, 2, or 3 Flammable Liquids (US), nor more than 120 US gallons of Category 4 Flammable Liquids (US).

Do not store combustible materials (e.g., cardboard, paper, wood) inside flammable liquid storage cabinets.

Do not locate more than three storage cabinets in a building, unless cabinets are placed in groups of three or less in one location and the groups of cabinets are placed at least 30 m (100 ft.) apart.

3.1.2 STORAGE IN BUILDINGS

Flammable or combustible materials normally used in gas compressor, pump shelter or densitometer/instrument/sample building, may be stored there in quantities no greater than those required for everyday use in accordance with Applicable Legislation.

Store excess flammable or combustible materials (greater than those used daily) in a separate structure built of non-combustible material and located a safe distance from gas compressor buildings, pump shelters and densitometer/ instrument/ sample buildings.

Ventilation for Storage cabinets approved for fire protection are not required to be vented to the outdoors; however, where respiratory or other health hazards may exist from the accumulation of hazardous vapors, positive mechanical ventilation is required. Where ventilation systems are not used or required, closures for ventilation within cabinet openings shall remain in place.

3.1.3 SPILL CONTAINMENT

Emergency spill cleanup equipment shall be readily accessible in close proximity to permanent fuel storage tanks.

If hazardous materials are stored in drums at a site, a hazardous materials spill kit shall be available at the site.

When transferring hazardous materials to or from storage tanks and drums, ensure spill control devices (e.g., spill pallets, absorbent pads, trays) are available, and use them to prevent contamination of soil, surface runoff water and groundwater.

3.1.4 TRANSPORTING HAZARDOUS MATERIALS

All hazardous materials shall be transported in accordance with the Hazardous Materials Transportation (HAZMAT) regulations [USA], or with the Transportation of Dangerous Goods (TDG) regulations [CAN].

Persons who handle for transport, offer for transport or transport dangerous goods shall have valid HAZMAT (US) or TDG (CAN) certification and carry proof of certification at all times while performing work (when required by Applicable Legislation).

3.1.5 TRANSPORTATION OF FUEL OR LIQUID HAZARDOUS MATERIALS

Do not transport or store extra fuel for vehicles and equipment in vehicle trunks or in passenger compartments.

Extra fuel for equipment shall be carried in approved containers that comply with CSA B376 [CAN] or with NFPA 30 and HAZMAT Regulations [USA].

Any vehicle containing hazardous materials in amounts greater than or equal to 450 kg (1000 lb.) or 500 L (119 gal in the USA) shall have a placard affixed on each exterior side, showing the type of material being transported. Tank trucks shall carry placards at all times unless the truck has been completely purged and cleaned.

3.1.6 REQUIRED DOCUMENTATION

Obtain shipping documents [CAN]/manifests [USA] from the material supplier. Shipping documents or manifests may be in any form as long as they include the following:

- Name of material,
- Hazardous class,
- Identification number,
- Total quantity, and
- Emergency contact (Chemtrec 1-800-424-9300).

If a contracted vacuum truck or tank truck is used, give the driver a copy of the shipping documents [CAN] or manifests [USA] and SDS.

Trucks used to transport hazardous materials shall have a current copy of the *Emergency Response Guidebook* in the cab of the vehicle.

All transported hazardous materials shall be properly labeled in accordance with TDG or HAZMAT.

In the USA, manifests are not required when transporting materials of trade on a single motor vehicle and not exceeding 440 lb., such as:

- Up to 1 lb. or 1 pt.-size of Packing Group I material in a container;
- Up to 66 lb. or 8 gal of Packing Group II, III or ORM-D;
- Up to 400 gal of diluted (not over 2%) Class 9 material; and
- Cylinders (no larger than 220 lb. capacity) of 2.1 or 2.2 material.

3.2 COMPRESSED GAS CYLINDERS

Compressed gas cylinders shall:

- Have connection points free of debris before attaching cylinders, hoses, valves, regulators or other fittings;
- Be legibly marked, by stenciling, stamping or labeling with either the chemical or trade name of the gas; the markings shall not be easily removable;
- Have Cylinder valves closed and have shipping caps in place when the Cylinder is not in use;
- Have only one key or handle for each manifold in multiple cylinder installations; and
- Not be exposed to extremely high temperatures (above 52°C or 125°F).

Contact the supplier if any part of the Cylinder or attachments is not working properly.

Do not force valves or tamper with safety features on compressed gas Cylinders.

Segregate flammable gases and compressed oxygen as per Applicable Legislation

Ensure “NO SMOKING” and other applicable signage is posted in the area entrances, or as required by Applicable Legislation

When in use, compressed gas cylinders shall:

- Be secured with non-combustible materials or means;
- Have fixed hand wheels, unless they have keys, handles or non-adjustable wrenches on valve stems;
- Use only appropriate torch and regulator valves to control the flow of gas;
- Not be brought into enclosures/Hoardings, and shall be kept outside with a hose run into the enclosure/Hoarding if the cylinder contains flammable gas or nitrogen; and
- Ensure that a flashback device is installed (as per manufacturers’ specifications) and that a back-flow prevention device is installed at the torch end, when gas-welding, cutting equipment or torches are used.

Gauges, regulators and fittings shall:

- Be bled down upon completion of work;

- Have the valve closed and all pressure released prior to being removed;
- Be disconnected when the Cylinder is not in use;
- Have the regulator pressure-adjusting screw fully released prior to attachment; and
- Have broken gauge lenses replaced prior to use.

In addition to the above, oxygen cylinder gauges, regulators and fittings shall:

- Have a fully open valve when in use to prevent leakage around the stem;
- Not be used with oil or grease as a lubricant on regulators as it may cause an explosion; and
- Be marked "USE NO OIL".

3.2.1 COMPRESSED GAS CYLINDER STORAGE

Indoor storage practices for compressed gas cylinders shall be in accordance with Applicable Legislation including fire and building codes and the following requirements shall be met:

- Vented room with air exchange;
- Explosion proof lighting;
- Properly rated fire walls separating the storage space from other nearby spaces/areas;
- Storage room shall have at least one exterior wall along an outside wall in a space;
- Storage room shall be located away from machinery;
- Flammable gas shall be stored outdoors unless specific fire code, and requirements and manufacturer's specifications are met; and
- Ensure "NO SMOKING" and other applicable signage is posted in the area entrances and as required by Applicable Legislation.

When stored, Cylinders shall be:

- Placed up-right (unless the cylinder contains a non-flammable gas which is designed to be stored on their side);
- Away from sources of heat;
- Placed In a storage area at least 1.5 m (5 ft.) from building (if in an outdoor storage unit);
- Secured with non-combustible materials (preferably chained);
- Located in a dry, well-protected, well ventilated location; and
- Placed at least 6 m (20 ft.) from highly combustible materials or separated by a fire resistant barrier no shorter than 1.5 m (5 feet) with a 30 minute fire rating.

All flammable gases and compressed oxygen shall be separated from each other and reference applicable legislation for additional requirements.

3.2.2 COMPRESSED GAS CYLINDER TRANSPORT

During transport, compressed gas Cylinders shall:

- Be secured;
- Have shipping caps in place;
- Be transported on hand trucks designed for the task; and
- Not be dragged, rolled or slid.

Compressed gas cylinders being hoisted shall:

- Be secured on a cradle, cage, sling board; and
- Not be hoisted or transported by means of magnets or choker slings.

Compressed gas Cylinders mounted on portable welding units shall:

- Have acetylene secured in the upright position;
- Have oxygen and nitrogen secured in either vertical or horizontal position as required by Applicable Legislation;
- Have valves closed and protective caps in place when not in use; and
- Have mounting arrangements that hold the Cylinder securely in the event of a rollover or other traffic Incident.

3.2.3 AEROSOL CANS

Aerosols shall be:

- Kept under cover and protected from exposure to the weather and direct sunlight when being used intermittently for work (i.e., air horn);
- Kept at least 3 m (10 ft.) from any source of heat or ignition; and
- Secured in a flammable storage cabinet when stored.

3.3 PROPANE BOTTLES AND ACCESSORIES

Do not use the valve to regulate the flow of propane. Ensure that the valve is either fully closed or fully opened.

Store propane bottles as follows:

- Outdoors on concrete or other non-combustible platforms;

- In an area that provides protection from tampering;
- In an area free of vehicle or mobile equipment travel; if propane bottles are required to be temporarily stored in areas where vehicle traffic is expected, then they shall be protected by barriers;
- Away from a fire escape, stairs or building egress;
- At least 7.5 m (23 ft.) away from buildings, unless in an approved storage cabinet; if using an approved storage cabinet, then store 1 m (3 ft.) away from buildings and 3 m (9ft.) away from air intakes;
- At least 1 m (3 ft.) from other flammable compressed gas containers (e.g. acetylene); and
- At least 6m (20 ft.) from containers or dispensers for flammable liquids and combustible liquids (e.g., gasoline and diesel fuel), or cylinders of compressed oxygen.

3.4 LEAKS AND SPILLS

Contractor shall have a plan to address any spill, leak or potential contamination by Hazardous Materials. Contact the Company Representative to assist with any spill, leak or potential contamination by Hazardous Materials.

4.0 REFERENCES

Alberta Fire Code

Emergency Response Guidebook

National Fire Code of Canada

OSHA 1910 Subpart H

OSHA 1910 Subpart Q

OSHA 1926 Subpart D

OSHA 1926 Subpart F

OSHA 1926 Subpart J

OSHA https://www.osha.gov/SLTC/trucking_industry/transportinghazardousmaterials.html

Transportation of Dangerous Goods <https://www.tc.gc.ca/eng/tdg/safety-menu.htm>

<END OF DOCUMENT>



Contractor Safety Specification

Tools & Equipment

Table of Contents

1.0	Definitions & Acronyms.....	2
2.0	Contractor Responsibilities	2
3.0	Specification Requirements	3
3.1	Tools and Equipment Use, Maintenance and Inspection Requirements.....	3
3.2	Tools and Equipment Guarding Requirements	4
3.2.1	Shear Points and Rotating Parts	4
3.3	Tools and Equipment Out of Service Requirements	4
3.4	Hand Tools.....	5
3.4.1	Open Bladed Knives	5
3.4.2	Power Tools Requirements (Portable Cord-and-Plug Connected Electric Equipment)	5
3.4.3	Explosive Actuated Tools	6
3.5	Post Pounders.....	7
3.6	Ladders	7
3.7	Equipment.....	8
3.7.1	Electric Equipment	8
3.7.2	Fuel Operated Tools.....	9
3.7.3	Air-Operated Tools and Equipment.....	9
3.7.4	High Pressure Water Jetting Equipment	10
3.7.5	HydroVac Equipment	11
3.7.6	Abrasive Blasting Equipment	12
3.7.7	Portable Heaters	13
3.8	Brush Cutting and Vegetation Management	14
4.0	References.....	15
5.0	Appendix A—PPE Requirements	16

1.0 DEFINITIONS & ACRONYMS

Adaptor cord—used to accommodate an explosion proof fitting to a regular flexible power cord.

Enbridge – Enbridge, Inc and Enbridge (U.S.) Inc., hereinafter will be referred to as “Company”.

Flexible power cords—power cords, extension cords, etc.

Open blade knife—is a cutting tool with an exposed blade, hand-held or otherwise, with or without a handle. It does not include hand held saws, grinders or other power tools that may be used for cutting purposes.

PPE—Personal Protective Equipment

Qualified Electrical Worker—one who has demonstrated skills and knowledge related to the construction, operation and maintenance of electrical equipment and installations. Depending on jurisdiction, may have to be a certified Journeyman Electrician.

Qualified—one who, by possession of a recognized degree, certificate, or professional standing, or who, by knowledge, training and experience, has successfully demonstrated his ability to solve or resolve problems relating to the subject matter, the work, or the project.

2.0 CONTRACTOR RESPONSIBILITIES

Contractor Management shall:

- Tools and equipment provided to workers are approved for use (where required) and in good condition for the work,
- Inherent hazards and safety features associated with the use of tools and equipment are assessed when selecting for purchase (e.g., ergonomics, noise, guarding, automatic shut off, dual trigger, etc.),
- Workers have the appropriate training to use the tools and equipment appropriately prior to use,
- Workers are aware of the hazards and associated controls when using tools and equipment,
- Workers are wearing appropriate PPE as required when using the tools and equipment, and
- Workers use the proper tool for the work task and that the tool or equipment is used for its intended purpose.

Workers shall:

- Inspect tools or equipment prior to use (document if applicable),
- Maintain and use tools and equipment appropriately,
- Report any defect or issue to their supervisor and tag the tool or equipment out of use (e.g., “Do Not Use” or “Do Not Operate”),

- Complete required training on tools and equipment prior to use (when applicable),
- Be aware of any hazards associated to the use of the tools or equipment and the means of controlling those hazards,
- Wear appropriate PPE,
- Use the tool or equipment for its intended purpose and in accordance with the manufacturers' specifications,
- Use the best tool or equipment for the task—consider ergonomics, congestion, weather and available safety features, and
- Ensure when using a tool or piece of equipment when working with other workers that positioning is communicated and situational awareness is maintained at all times.

3.0 SPECIFICATION REQUIREMENTS

Company recognizes the potential for hazards in working with tools, equipment or power tools and requires all workers to put the appropriate risk control methods in place, in adherence to this specification, to eliminate or mitigate the potential hazards.

3.1 TOOLS AND EQUIPMENT USE, MAINTENANCE AND INSPECTION REQUIREMENTS

All tools, equipment, and power tools shall be:

- Locked out (if applicable) or unplugged to isolate hazardous energy prior to servicing, maintaining or inspecting,
- Inspected, maintained and used according to Company requirements, manufacturers' specifications and applicable legislation,
- Used for their intended and approved purposes only,
- Tagged out "Do Not Operate" and removed from service if found to be defective or malfunctioning and reported to supervision, and
- Operated in accordance with the manufacturers' weather and temperature limitations (review prior to use in extreme weather conditions).

Maintenance activities on tools, equipment and power tools shall be:

- Completed by Qualified Workers, and
- Returned to a manufacturer-approved centre for service, repair, calibration or adjustment at the required intervals.

All Contractor tools, equipment, and power tools dispatched to a Company location shall:

- Be in good working order, and
- Have the relevant operation, testing and maintenance records, plus maintenance instructions available upon request.

3.2 TOOLS AND EQUIPMENT GUARDING REQUIREMENTS

Guards shall be used to protect workers from hazards created by point of operation, rotating parts, flying chips, or other hazards.

Guards and protection (e.g. protective devices) shall:

- Meet manufacturers' specifications and applicable legislation,
- Be in good working order and inspected regularly,
- Not be modified or removed,
- Be replaced if damaged,
- Be the correct size,
- Be secure, and tamper-proof, and
- Prevent falling objects (if applicable).

When broken guarding is removed, temporary guarding that meets manufacturer's standards can be used, but original equipment manufacturer (OEM) guarding must be in place as a permanent repair.

Note: Always use push sticks, guards, shields or other devices as appropriate to avoid putting your fingers in pinch points.

3.2.1 SHEAR POINTS AND ROTATING PARTS

Shear points and cut points shall be:

- Guarded in a manner that encloses the points within the machinery or equipment, or
- Otherwise guarded to prevent the operator from being exposed to the hazard.

Around rotating parts, workers shall not wear loose-fitting garments or jewelry. Workers with long hair shall keep their hair tied back to avoid entanglement.

3.3 TOOLS AND EQUIPMENT OUT OF SERVICE REQUIREMENTS

Any and all equipment that is not suitable for use (e.g., defective, guards removed, modified, damaged) shall be:

- Removed from service and disposed of or submitted for repair,
- Tagged out with 'DO NOT OPERATE',
- Tagged with the name of person removing from service, and
- Tagged with the date removed from service.

3.4 HAND TOOLS

All hand tools shall be:

- Inspected according to manufacturers' specifications prior to use,
- Used and maintained in accordance with manufacturers' specifications, and
- Tagged and removed from use whenever damaged or not suitable for use.

3.4.1 OPEN BLADED KNIVES

Open bladed knives shall only be:

- Used with prior written approval from regional or project management, and
- Approved once it's determined on a hazard assessment that alternate tools are not reasonably practicable to complete the task.

When it is determined that an open bladed knife is the only tool that can be used to complete a task, the following criteria shall be met:

- Identified specific PPE is worn at all times when using open bladed knives,
- Material being cut is secure,
- Only fixed blades are used,
- Working space is appropriate to the task and allows the worker to work with the open bladed knife in a safe manner without endangering themselves or others, and
- Worker uses the knife to cut away from their body.

3.4.2 POWER TOOLS REQUIREMENTS (PORTABLE CORD-AND-PLUG CONNECTED ELECTRIC EQUIPMENT)

Company recognizes that equipment and power tools have inherent hazards associated to their operation and require practices specific to mitigate those hazards.

3.4.2.1 POWER TOOLS AND FLEXIBLE POWER CORDS:

Electrical extension cords shall be:

- Rated for extra hard usage (i.e. SOOW S-service, OO-Oil resistant insulation and jacket, W-weather resistant)) and the rating must be visible,
- Only used as a temporary power source,
- 3-wire type,
- "W" rated if being used outside,
- Immediately removed from service and tagged deficient if physically damaged, modified, or sub-standard (ex: outer jacket cut, prong missing, or an under rated equipment cord),
- Assembled or repaired only by a qualified electrical worker,

- Routed in such a way as to:
 - Keep cord connections out of water,
 - Prevent any tripping hazard.
 - Avoid mechanical damage, and
 - Use only temporary means when attaching cords to structures (ex: cable ty-raps, electrical tape, barricade tape, etc.).

GFCI protection must be used when:

- Operating portable electrical tools or equipment outdoors,
- Operating portable electrical tools or equipment indoors where water, moisture or wet conditions are encountered,
- Using a non-explosion proof style adaptor cord,
- Using an extension cord with a receptacle (not just a plug) at one end, and
- Power is being supplied by a receptacle on a generator, welder, lighting plant inverter or other temporary power source.

Before using a GFCI it shall be function tested by pushing the TEST and RESET buttons.

When working with power tools, workers shall:

- Unplug the tool prior to attaching or removing bits, blades or other accessories, and
- Ensure all tools and equipment are set to the “off” position prior to plugging them in.

3.4.2.2 GRINDERS AND BUFFERS

Workers using hand-held grinders and buffers shall:

- Ensure that sparks and debris are controlled,
- Unplug the tool when changing wheels or guards,
- Inspect the grinder to ensure it is in safe operating condition and that the wheel is free of cracks and other defects,
- Ensure the disc is the correct size and type for the grinder and is approved for more revolutions per minute than the grinder,
Ensure all components are properly secured and in place,
- Ensure there is no locking switch (these are prohibited), and
- Ensure the dead man switch has not been modified to prevent proper operation.

See Appendix A for PPE requirements.

3.4.3 EXPLOSIVE ACTUATED TOOLS

If an explosive actuated tool is to be used, the Company representative shall be advised prior to use.

Workers shall:

- Be qualified in the use of explosive actuated tools,
- Have training records available,
- Adhere to hot work requirements when using explosive actuated tools, and
- Dispose of live power shot load(s) appropriately.

3.5 POST POUNDERS

Any work involving post pounders shall have written procedures and hazard assessments for its use. Refer to *Ground Disturbance Specification* for additional guidance.

The manual post pounder design shall:

- Address the risk to the worker from the pounder coming off of the post, and
- Include effective ergonomic principals promoting ideal body positioning (i.e., longer post pounder).

If practical, use mechanical means such as slide hammers or air actuated hammers to reduce the potential for improper body positioning risk to the worker.

3.6 LADDERS

Ladders shall:

- Be used as per manufacturers' specifications,
- Be inspected before each use for any cracks or defects; if defective, repair immediately, or tag and remove from service,
- Be carried horizontally below shoulder level,
- Have the proper weight rating for the task,
- Not be erected on boxes, carts, tables, or other unstable surfaces, and
- Be inspected periodically and after any occurrence which could affect their safe use.

Workers using ladders shall:

- Always face the ladder when going up, down or performing any work activity,
- Maintain three-point contact at all times when climbing or descending,
- Ensure the ladder's feet are placed on a firm and level base,
- Use Fall Protection when working from a ladder rung at a height of 1.83 m (6ft.) or higher,
- Use only non-conductive side rail ladders unless in greenfield locations with Company representative approval,
- Not straddle the space between a ladder and another object,
- Prevent foot traffic from entering the area where the ladder is located as per hazard assessment,

- Ensure that all articles that impede the ability for three points of contact with the ladder shall be lifted by another means,
- Lift or lower larger articles from elevated locations by a hand line or a hoist,
- Have ladders above 1.83m (6 ft.) held by a second worker when it is not secured, and,
- Secure ladders at the base, when a kick-out hazard exists.

Step Ladders shall:

- Be placed at right angles to the work,
- Not be used to brace or support work, and
- Not have either of the top two steps used for footing.

Extension ladders shall:

- Have the base of the ladder placed at an operating angle of 4 feet of rise to 1 foot out at the base,
- Extend at least 1 m (3 ft.) above the landing platform,
- Be tied off at the top of the ladder to prevent it from slipping or being moved or blown over,
- Have slip-resistant footing and rungs,
- Be climbed in accordance with the information included on the ladder label for usage and manufacturers specification,
- Have the locking ladder hooks secure before climbing, and
- Not have the last three rungs from the top of the ladder used for footing.

3.7 EQUIPMENT

3.7.1 ELECTRIC EQUIPMENT

When working with electric equipment, workers shall follow these requirements:

- Portable electric equipment is grounded or double insulated,
- Unattended temporary electrical equipment (such as lights, heaters, etc.) that will be left on in a Class 1, Div. 2 or Zone 2 area must follow the requirements of the CEC Part I or NFPA 70 standards, and
- Portable generators used on the worksite shall be grounded, in accordance with manufacturers' specifications.

Only Qualified Electrical Workers can:

- Inspect or repair defective portable electrical equipment,
- Install temporary wiring for a temporary power supply (e.g., where needed for portable electrical tools, equipment, and lighting units), and

- Specify and install temporary power systems as per the requirements of the Electrical Safety Specification.

3.7.2 FUEL OPERATED TOOLS

Hazardous energy shall be controlled prior to performing maintenance on fuel-operated tools i.e., chainsaws and brush cutters.

Workers using fuel operated tools shall:

- Be qualified and competent in the operation of the specific tool,
- Meet legislated and/ or company-specific training and certification requirements (where required), and
- Wear required PPE, in accordance with the hazard assessment.

3.7.2.1 CHAINSAW OPERATION

When using chainsaws, all operators shall have access to an appropriate personal first aid kit, spill kit and fire extinguisher. In addition, they shall have an effective means of communication for summoning assistance when required.

See Appendix A for additional requirements.

3.7.3 AIR-OPERATED TOOLS AND EQUIPMENT

Workers using air-operated tools shall:

- Set the air supply properly for the tool being used
- Ensure that air is drained from the line prior to disconnecting tools when not using a quick connect tool,
- Never use air-operated tool for cleaning workers or clothing,
- Use safety nozzles, plus effective chip guarding on applicable tools,
- Ensure air-operated tools do not exceed 30 psi when cleaning equipment or floors,
- Not adjust the compressor to operate above the manufacturer's specified rating,
- Be qualified on the brand/ model of equipment they're using to operate all equipment with brand/model specific attachments including quick connect couplers, and
- Document and ensure that the installation of the quick coupler itself is performed according to the manufacturer's specifications.

Workers using impact wrenches shall:

- Ensure directional lever is in the correct position prior to loosening or tightening a bolt or nut (refer to the manufacturers' specifications for appropriate means of attaching a socket to a larger impact wrench when a locking mechanism is required), and
- Ensure everyone's hands remain clear of pinch points such as the area around socket or reaction arm.

Pneumatic hoses shall:

- Be appropriately rated for the maximum pressure produced in systems,
- Have excess flow valves or chokes installed on all airlines at the compressor or header to prevent high-volume air release,
- Have temporary and quick connections secured using whip checks on all connection points,
- Have safety pins where the connection point is designed for their use,
- Have safety clips or retainers used at the attachment point on pneumatic impact percussion tools,
- Be protected from tangles, unnecessary wear and damage, and
- Have a safety device at the source of supply or a branch line to reduce pressure in case of hose failure for all hoses exceeding ½-inch inside diameter.

3.7.4 HIGH PRESSURE WATER JETTING EQUIPMENT

All water based cleaning operations conducted at pressures 5,000 psi or more or which develop more than 22 ft. lbs. of force shall be considered high pressure water jetting (HPWJ). Pressure washing shall be defined as water-based cleaning operating at less than <5,000 psi and producing no more than 22 ft. lbs. of force.

Only qualified workers (min. two) shall complete HPWJ activities and follow appropriate work procedures.

When conducting high pressure water jetting, the workers shall ensure:

- Equipment operator nearest the high-pressure nozzle can immediately reduce pressure or interrupt the flow to the nozzle,
- At least one control valve or switch controls each high-pressure tool,
- A worker operates only one high-pressure lance, mole or shotgun at one time,
- High-pressure cleaning hose is positioned and handled to minimize bends and turns,
- High-pressure hose connections shall have whip checks and connections properly secured,

- When cleaning piping systems:
 - open access is provided at least every 30 m (100 ft.), and
 - Flanged elbows or spool sections of pipe are removed,
- System is depressurized when:
 - Not in use,
 - Unauthorized or inadequately protected workers enter the work area,
 - Replacement or repairs are made to the equipment, including tightening or loosening fittings, and
 - Recommended practices are violated.

See Appendix A for additional requirements

3.7.5 HYDROVAC EQUIPMENT

Hydrovacating equipment shall include:

- Hoses, fittings and attachments rated and designed for the maximum specified operating pressures of the equipment,
- Systems capable of constant monitoring of temperature and pressure to ensure that allowed operating limits are not exceeded,
- Wand tips designed to prevent a concentrated water stream,
- Wands of sufficient length to prevent the operator from contacting the wand tip while the wand is in operation,
- A relief system capable of relieving the full capacity of the pump at maximum rpm (to protect the weakest component in the system),
- A shut-off valve on the wand or a water shut-off switch on a remote control that is manned by a second worker,
- Restraining devices on couplings to prevent accidental disconnection (where couplings provide for such devices), and
- A neoprene or equivalent lip on the vacuum tube end to eliminate any mechanical damage to the facility.

Due to static electricity, ground the vacuum excavating system during operations.

Equipment must be operated within manufacturer's specifications and applicable regulations at all times.

The working water pressure must not exceed 17,250 kPa (2500 psi). When excavating within 0.3 meters (1 ft.) of known or suspected underground facilities, the pressure must be reduced to less than 10,350 kPa (1500 psi) and the water temperature limited to 38° C (100° F).

3.7.6 ABRASIVE BLASTING EQUIPMENT

Abrasive Blasting shall only be completed by qualified workers and shall follow the appropriate work procedures when conducting the work.

Workers using abrasive blasting equipment shall:

- Post warning signs within 15 m (50ft) of the work area and erect barricades or flagging as required,
- Test safety shutdown and control (deadman) switches daily,
- Document equipment-specific daily inspection details,
- Use intrinsically safe switches and complete atmospheric monitoring when applicable, or as determined by the hazard assessment,
- Have whip checks, clips and wires properly installed on hoses to prevent accidental decoupling,
- Have a worker rotation plan in place when performing abrasive blasting for extended periods to reduce exposure time,
- Implement dust control measures as required,
- Ensure fresh air supply systems are inspected and calibrated within six months of use, and
- Control the end of the blast hose to protect themselves and co-workers.

The blast nozzle control (deadman) switch shall:

- Be located near the nozzle in a position where the operator's hands will be when using the device,
- Not be disabled for any reason,
- Immediately stop the flow of material when released,
- Be guarded, to prevent accidental activation.

Abrasive blasting equipment used to clean tanks shall:

- Have the blasting hose nozzle bonded electrically to the tank shell or the tank roof if the blast nozzle(s) are conductive.

Abrasive blasting within 3 m (10 ft.) of any tank vent— whether or not the vents are open— is not allowed, unless the tank has been cleaned and declared gas free by a qualified worker; if a tank has not been cleaned and declared gas free, clean areas within 3 m (10 ft.) of tank vents with hand tools such as scrapers, wire brushes and similar equipment.

If abrasive blasting operations occur on NGL lines, then they shall adhere to requirements as outlined by the Company.

Exception: Abrasive blasting of external floating tank roofs may be performed in accordance with API RP 2027 and approval of the Company Operations representative

See Appendix A for additional requirements.

3.7.7 PORTABLE HEATERS

All portable heaters shall:

- Be properly grounded and plugged into a GFCI when electric (if required),
- Be attended when in operation based on hazard assessment requirements,
- Not be placed on or near combustible or flammable materials or surfaces, and
- Be in proximity to a readily available fire extinguisher,
- Be used in accordance with the manufacturers' specifications, and
- Have initial and continuous atmospheric monitoring when placed in a Class 1, Div. 2 or Zone 2 area.

Portable fuel heaters shall:

- Be operated only where there is adequate ventilation,
- Be placed outside of the enclosed or confined space away from openings —along with the fuel, and
- Have ongoing atmospheric monitoring when heated air is being introduced to enclosed spaces occupied by workers.

All diesel powered portable heaters shall follow the Company Positive Air Shut Off requirements found in the *Hot Work & Ignition Source Specification*.

Portable catalytic heaters shall:

- Be approved for use in an explosive or hazardous atmosphere; approval shall be from an applicable, recognized authority such as the Canadian Gas Association (CAN) or American Gas Association (USA),
- Have continuous monitoring when used in an explosive or hazardous atmosphere,
- Have adequate ventilation to prevent a build-up of exhaust fumes and to prevent the fumes from being drawn through the heater and into the space being heated,
- Have carbon monoxide monitors when required,
- Have only explosion-proof electrical fittings attached,
- Have a regulator between the propane bottle and the heater to reduce the pressure of gas to the heater, to a level specified by the manufacturer,
- Have a thermostatic block valve installed on the propane line where it enters the heater,
- Not be used in electrical enclosures where there are open relays, and
- Be used only in accordance with manufacturer's specifications.

3.8 BRUSH CUTTING AND VEGETATION MANAGEMENT

When using motorized equipment for cutting or clearing brush, Workers shall:

- check the cutting area for any metal, large stones or other hard material that could damage the blades or cutter disc
- regularly clean accumulated debris from the top of the cutter's fuel tank and from the engine, pumps and axle protection plates on a regular basis
- ensure other Workers do not approach the brush cutter's articulating joint when the brush cutter is operating
- operate brush cutters with protective guards installed
- wear additional PPE as required by the Hazard Assessment
- ensure each brush cutter has protective guards and only operate brush cutters with the guards installed
- dispose of brush and slash by mulching and spreading on an area designated by the regional/project manager or an Company ROW agent or landowner

A Worker shall not operate a brush cutter when other workers are within 150 m (500 ft.) of the front or sides of the brush cutter (see manufacturers' recommendations).

Brush cutting is a Ground Disturbance activity when it meets the criteria in the Ground Disturbance definition. Ground Disturbance precautions shall be in place prior to beginning brush cutting.

When overhead clearing of vegetation is being completed, all applicable precautions will be implemented. If clearing is required within limited approach boundary to overhead powerlines a certified and / or licensed professional arborist will be utilized to perform the work. Refer to *Safe Limit of Approach and Entry - Power Lines & Substations Contractor Specification*.

4.0 REFERENCES

Occupational Safety and Health Administration (OSHA)

- Ladders, 29 CFR 1910.23
- Tools – Power-operated Hand Tools, 29 CFR 1926.302
- Guarding of Portable Powered Tools, 29 CFR 1910.243
- The Control of Hazardous Energy (Lockout/tagout), 29 CFR 1910.147
- Eye & Face Protection, 29 CFR 1910.133
- Head Protection, 29 CFR 1910.135
- Hand Protection, 29 CFR 1910.138

Canada Labour Code, Part II; Canadian Occupational Safety & Health (COSH) regulations

- Portable Ladders, 3.1
- Hearing Protection, 7.7
- Eye & Face Protection, 12.6
- Tools & Machinery, 13.1
- Operation & Use of Tools, 13.2
- Machine Guards, 13.13

5.0 APPENDIX A—PPE REQUIREMENTS

PPE					
(In addition to the minimum PPE required for all Company Worksites)					
Work Activity	Eye, Face & Hearing		Hand	Body	Respiratory Protective Equipment (These are the minimum requirements; a higher level of RPE may be required based on Atmospheric Monitoring)
	Abrasive Blasting	Abrasive Blasting helmet or hood.	Leather or Canvas gauntlet gloves.	Heavy duty blast suit or leather apron.	Blaster and helpers/workers in immediate vicinity of blasting: Type CE supplied air abrasive blasting respirator, hood or helmet with apron, operated in continuous flow mode.
Hearing protection.		Open Space			Helpers and workers in the blast area (within 30 m (100 ft.) downwind, 15 m (50 ft.) upwind, 23 m (70 ft.) if no wind); disposable P100 respirator or half-mask APR with P100 filter.
		Confined Space			Helpers and workers in the blast area same as Blaster.
Abrasive Blasting with Self-Contained System (e.g., Blastrac)	As per assessment of all potential and existing hazards.			Half-mask APR with P100 dust filter.	
Operating Chainsaws or Metal Blade Weed Trimmers	Full-face shield or impact-resistant	Leather gloves	Kevlar leg chaps or pants.		
	Hearing Protection				
Chipping, Hammering Metal, Sledge or Jack Hammering; or Using Compressed Air; or Operating Electric and/or Hand Saws; or Concrete Work	Full-face shield and/or impact goggles.	Leather or Kevlar gloves.	As per potential and existing hazards	As per potential and existing hazards. Consider type and quantity of particulates being generated.	

Work Activity	Eye, Face & Hearing	Hand	Body	Respiratory Protective Equipment (These are the minimum requirements; a higher level of RPE may be required based on Atmospheric Monitoring)
Wire Brushing, Buffing, Cutting, Grinding (electric and pneumatic, including cut-off and concrete saws)	Welding helmet and safety glasses under helmet; or full-face shield or full-face shield and impact-resistant goggles. Hearing protection.	Leather gauntlet-type gloves (with seams on the inside).	As per potential and existing hazards	As per potential or existing hazards.
High Pressure Water Jetting and pressure washing at 2000 psi or greater	Full-face shield Hearing Protection	Heat and water resistant gloves- Minimum Cut level 4	Metatarsal protection, knee length with ribbed steel shanks and heavy tread soles for nonslip traction. Additional PPE may be required based on potential and existing hazards.	As required by potential or existing hazards.

<END OF DOCUMENT>



Contractor Safety Specification

Vehicle Operation

Table of Contents

1.0	Definitions & Acronyms.....	2
2.0	Contractor Responsibilities	2
3.0	Specification Requirements	3
3.1	General Requirements for Drivers	3
3.2	Vehicle Safety Check	3
3.2.1	Pre-use Walk-around	3
3.3	Distracted Driving and Use of Communication Devices.....	4
3.3.1	Safe Use of GPS Equipment.....	4
3.4	Vehicle Operation.....	4
3.4.1	Towing.....	5
3.4.2	Safe Use of Trailers and Hitches.....	6
3.4.3	Vehicle Fueling.....	6
3.4.4	All Terrain and Off-Highway Vehicles (OHVs).....	6
4.0	References.....	7

1.0 DEFINITIONS & ACRONYMS

ATV—All Terrain Vehicle.

DOT – Department of Transportation

Enbridge—*Enbridge, Inc. and Enbridge (U.S.) Inc., hereinafter will be referred to as “Company”.*

GPS –Global Positioning System

Highway vehicle—A vehicle equipped with design features that enable it to be normally operated and to mix with regular traffic on public roads, including highways, *streets*, bridges, etc.

Off-highway vehicle—A vehicle designed primarily for recreational use or for the transportation of property or equipment exclusively on undeveloped road rights of way, marshland, open country or other unprepared surfaces.

Qualified- one who, by possession of a recognized degree, certificate, or professional standing, or who by knowledge, training and experience, has successfully demonstrated their ability to solve or resolve problems relating to the subject matter, the work, or the project

ROPS – Rollover Protective Structure

UTV—Utility Terrain Vehicle (side-by-side).

2.0 CONTRACTOR RESPONSIBILITIES

Worker/drivers shall:

- Ensure all contractor workers understand and comply with the requirements of this Specification
 - Comply with all other applicable driving-related Company policies and procedures;
- Adhere to applicable driving laws;
- Operate vehicles in safe operating condition;
- Have the correct license in their possession when operating the vehicle (when applicable);
- Complete pre-use walk around inspection;
- Immediately report all project related motor vehicle incidents (MVI) to their supervisor and project leadership
- Drive slowly and with caution, as appropriate, e.g., when road or driving conditions are poor or hazardous and/or when workers or other people are present;
- Maintain vehicles according to manufacturer’s specifications;
- Operate properly equipped and maintained vehicles; and

- Complete journey management when required.

3.0 SPECIFICATION REQUIREMENTS

3.1 GENERAL REQUIREMENTS FOR DRIVERS

When operating a vehicle, drivers shall:

- Ensure that the vehicle has current registration and insurance available in the vehicle;
- Properly use all of the safety mechanisms installed on vehicles, including seat belts,
- Ensure that all vehicle occupants are wearing their seat belts (when equipped) at all times when the vehicle is in motion;
- Secure materials, tools and equipment against movement when stowed in the cabin of vehicle or erect barriers to safely separate workers from stowed items;
- Have headlights on when in operation;
- Ensure vehicles have all required safety accessories;
- Ensure that only vehicles required for the completion of work activities are within the immediate worksite; all other vehicles shall be parked in approved areas.

All worksite/workforce vehicles 1 ton and over operating on Company worksites shall have backup alarms installed that:

- Operate automatically when reverse is engaged; and
- Are clearly audible above background noise.

3.2 VEHICLE SAFETY CHECK

3.2.1 PRE-USE WALK-AROUND

Workers and or Drivers shall conduct a pre-use walk-around of the vehicle prior to use, verifying safe working condition of the vehicle.

Report defects to your immediate supervisor. Defects that cause that vehicle to be considered inoperable shall be immediately corrected.

Workers and/or Drivers shall conduct a walk-around prior to moving a vehicle to check for:

- Potential obstructions and approach distances;
- Fluid leaks;
- Vehicle damage;
- Clear visibility, including any damage or cracks to the windshield and rear/side windows;

- Adequate tire inflation and any sharp objects or foreign material in the tire treads on land-based vehicles; and
- Ensure loads are secured prior to movement.

Report defects to your immediate supervisor. Defects that cause that vehicle to be considered inoperable (according to local Applicable Legislation) shall be immediately corrected.

3.3 DISTRACTED DRIVING AND USE OF COMMUNICATION DEVICES

The use of personal communication devices while driving is strictly prohibited on Company worksites/property and while working for the Company.

Drivers shall avoid distracted driving at all times.

Drivers or operators shall:

- Not engage in activities while driving that could cause distractions (talking on cell phone texting, entering information on GPS, reading printed materials); and
- Only use radios when operating a vehicle or boat on a radio controlled road/waterway or when deemed necessary by hazard assessment.

3.3.1 SAFE USE OF GPS EQUIPMENT

When using a global positioning system (GPS) in a vehicle, workers shall ensure:

- The GPS unit is equipped with hands-free navigation and is turned on prior to driving;
- The GPS unit is properly affixed to the vehicle prior to driving:
 - Affix in a position to not obstruct view of the road;
 - Affix in a position to not obstruct view of vehicle instrumentation.
- The GPS is programmed prior to driving; and
- The vehicle is safely parked prior to making programming changes to the GPS unit.

3.4 VEHICLE OPERATION

Workers operating vehicles shall:

- Pull through a parking space when it is possible;
- Back into a space when safe to do so;
- Use a spotter/signaler (if available) to direct the vehicle when reversing or when line of sight is limited;
- secure truck bed and trailer bed loads against movement;

- Have keys easily accessible so that the vehicle may be moved if necessary when required and the worksite is secure, e.g., due to site conditions or congestion, or in the event of an emergency;
- Never operate a vehicle with a person in the bed of the vehicle;
- Not allow any person on the bed of a truck during winching operations when stationary;
- Not operate a vehicle that is loaded in excess of maximum capacity;
- Honk prior to reversing when without back-up alarm;
- Park on working/right side of the roadway (if safe to do so) when parking on black top or gravel roadways;
- Maintain a 1m (3ft.) buffer zone around their vehicle (on each side, in front of, behind and above) except for curbs, spaces or facilities specifically intended for parking;
- Use a spotter signaler (if available) to direct the vehicle where the 1m (3ft.) buffer zone cannot be maintained; and
- Not stop, park or pass through the area without the equipment operator(s) acknowledging your presence; follow the directions of flag persons/traffic signals, when present.

3.4.1 TOWING

Whenever practicable, use a certified towing agency to recover a vehicle. If a towing agency is not used, follow these requirements when recovering a vehicle:

- Recovery straps shall be nylon, with sewn loops at each end and at least 6m (20ft.) in length;
- Use the vehicle recovery equipment in accordance with the manufacturer's specifications, e.g., do not exceed the pulling strength limits of the recovery straps; and
- Do not use lifting slings, snatch straps, chains or recovery straps manufactured with chain and hook attachments. Towing operations shall only be performed by qualified operators. All towing equipment shall adhere to the following requirements:
 - Vehicle recovery straps (tow ropes), including the attachment hardware, shall be labeled with their assigned strength and safety ratings;
 - Tow ropes and hardware shall be of adequate pulling strength to ensure the weight of the vehicle can be safely towed; and
 - Chains shall not be used for towing.

3.4.2 SAFE USE OF TRAILERS AND HITCHES

When using trailers and hitches, workers shall:

- Ensure hitch and receiver are compatible and correctly sized;
- Visually inspect trailers and hitches prior to each trip;
- Test signal and brake lights prior to departure;
- Test brakes (if applicable) prior to departure;
- Test and calibrate auxiliary brakes prior to departure; if equipped with breakaway cable, check the cable length and ensure the coupling is fully plugged in;
- Use adequately sized tow chains that are securely fastened;
- Cross the tow chains to prevent the hitch from contacting the ground if it becomes disconnected;
- Secure the coupling latch (e.g., pin, lock, bolt and nut) after coupling the trailer to the towing vehicle;
- Secure all loads; and
- Have the trailer ball-mount assembly removed from the receiver when not in use.

3.4.3 VEHICLE FUELING

When fueling vehicles, workers shall:

- Always shut off the vehicle before fueling;
- Never smoke near a fueling area or fuel station;
- Never smoke while fueling a vehicle;
- Never overfill a fuel tank;
- Never leave the fuel nozzle unattended;
- Never use a cellular device while fueling; and
- Always ensure the tank is bonded before fueling when fueling from an auxiliary fuel tank.

3.4.4 ALL TERRAIN AND OFF-HIGHWAY VEHICLES (OHVs)

The use of all-terrain vehicles (ATVs) on Company worksites requires the consent of the onsite Company representative. This requirement does NOT include utility terrain vehicles (UTVs) as defined.

Workers operating ATVs, UTVs and snowmobiles shall be trained and qualified in their use and authorized to operate the land vehicle.

Operators shall:

- Wear Snell/DOT approved helmets;
- Wear appropriate PPE, e.g., protective goggles and/or other suitable devices to prevent eye and face injuries from twigs, flying debris and weather conditions;
- Wear seatbelts when the vehicles safety system is designed for seat belt use;
- Not operate on a highway (crossing a highway is permitted);
- Receive permission prior to operation on private property; and
- Operate at speeds appropriate for the terrain, visibility, conditions, and experience.

Note: Within the fenced area of a facility, the maximum speed limit is 30kph/18mph unless the posted limit is lower.

Operators may wear a hard hat in place of a Snell/DOT approved helmet when driving on roads within Company facility sites, if the land vehicle is equipped with ROPS and a two point (lap) seatbelt and while maintaining the posted speed limit.

All ATVs, UTVs and snowmobiles shall:

- Be equipped with functioning headlights and tail lights;
- Have license plates securely attached in a visible location, as required by applicable legislation;
- Be equipped with a first aid kit, 5 lb. ABC fire extinguisher, and portable communication equipment (e.g. hand-held radio, cellular or satellite phone) as required;
- Be equipped with an aerial whip and flag when identified on a hazard assessment; and
- Be equipped with spark arrestors as required by applicable legislation.

UTVs and snowmobiles may only carry passengers when there is a passenger seat. Seat belts shall be worn by passengers when the vehicle safety system is designed for their use.

4.0 REFERENCES

Province of Alberta Traffic Safety Act: <http://www.qp.alberta.ca/documents/Acts/T06.pdf>

<END OF DOCUMENT>



Contractor Safety Specification

Walking-Working
Surfaces and General
Housekeeping

Table of Contents

1.0	Definitions & Acronyms	2
2.0	Contractor Responsibilities	2
3.0	Specification Requirements	2
3.1	General Housekeeping	3
3.2	Walkways, Stairways, Exits, Platforms, Landings and Openings.....	4
3.3	Scaffolds	5
3.4	Non-Mobile Elevated Work Platforms	8
3.5	Storage and Laydown Yards	9
3.5.1	Pipe Handling and Storage	10
4.0	References.....	12

1.0 DEFINITIONS & ACRONYMS

Barricade—An obstruction to deter the passage of persons or vehicles.

Enbridge—Enbridge, Inc. and Enbridge (U.S.) Inc., hereinafter will be referred to as “Company”.

Qualified Worker—One who, by possession of a recognized degree, certificate, or professional standing, or who by knowledge, training and experience, has successfully demonstrated his ability to solve or resolve problems relating to the subject matter, the work, or the project.

Sills—Means a wood, concrete or metal footing used to distribute the load from a standard, an upright or a base plate of a scaffold to the ground.

Walking-working surface—Means any horizontal or vertical surface on or through which a worker walks, works, or gains access to a work area or workplace location.

2.0 CONTRACTOR RESPONSIBILITIES

Contractors shall:

- Provision of sufficient resources to effectively implement this Specification;
- Ensure applicable inspections are completed and corrective actions are implemented on a timely basis; and
- Ensure required certifications are in place prior to work commencement.
- Immediately address deficiencies related to walking-working surfaces and general housekeeping requirements as detailed within this Specification;
- Notify Contractor Leadership immediately of found deficiencies that cannot be addressed by the worker; and
- Perform inspections as required.

3.0 SPECIFICATION REQUIREMENTS

All places of employment, passageways, storerooms, service rooms, and walking-working surfaces are kept in a clean, orderly, and sanitary condition.

The floor of each workroom is maintained in a clean and, to the extent feasible, in a dry condition. Walking-working surfaces are maintained free of hazards such as sharp or protruding objects, loose boards, corrosion, leaks, spills, snow, and ice.

Walking-working surfaces are inspected, regularly and as necessary, and maintained in a safe condition. Hazardous conditions on walking-working surfaces are corrected or repaired before a worker uses the walking-working surface again. If the correction or repair cannot be made immediately, the hazard must be guarded to prevent workers from using the walking-working surface until the hazard is corrected or repaired.

3.1 GENERAL HOUSEKEEPING

Good housekeeping practices shall be maintained at all Company locations including, administrative and field offices, staging areas, on or off-site storage areas, facility construction sites and right-of-ways (ROWs).

Suitable safeguards, flagging or barricades with warning signs or flashing lights shall be used to protect workers from any work activity that may endanger them. Examples of such activities include sand blasting, open excavations, temporary openings in floors, construction, arc flash in pre-fab areas, pressure testing or overhead work.

Barricades shall be inspected periodically to ensure protection for workers is adequate, and that they are still present and in good condition.

The use of industrial style dumpsters is recommended in areas where large volumes of waste can be expected. Garbage shall not be allowed to accumulate on a construction Right of Way. Ensure waste receptacles are emptied regularly and all garbage is collected and removed as required. Wildlife risks need to be assessed when determining waste receptacle and removal criteria.

To maintain a clean, hazard-free workplace, all groups shall follow the general practices for safe housekeeping which include but are not limited to:

- Ongoing worksite cleanup,
- Individual cleanup duties for all workers,
- Materials piled, stacked, or otherwise stored to prevent tipping or collapsing,
- Materials stored away from overhead powerlines, and
- Work, travel and emergency equipment areas kept tidy, well-lit, and ventilated.

Rebar, T-bar and other impalement Hazards shall be capped or otherwise protected.

Wheel chock blocks shall be used to prevent equipment from rolling and chocks or blocks to prevent heavy parts and equipment from falling. Check with fellow Workers before removing blocks.

Overhead ice buildup should be removed as soon as it starts to occur, to prevent the formation of a large mass that could potentially injure workers, or damage equipment. The removal method shall be determined based on the hazards present.

Workers shall take all appropriate measures to prevent slipping hazards in all work areas and walkways. Such measures or controls may include the application of sand or other approved materials that provide grip and traction.

In addition, all work areas and walkways shall be visually identifiable through signage, flagging, or other methods appropriate for the work and weather conditions.

At all times, work areas and walkways shall be maintained to minimize the risk of slips or falls, including:

- Covering of holes and openings,
- Good housekeeping,
- Removal or repair of uneven walking surfaces, e.g., repair of uneven floor boards, and
- Removal of unnecessary objects or equipment.

Work areas and walkways shall be kept clear of snow and ice. As appropriate, use authorized traction control aids, such as sand, gravel or an approved snow melt.

When weather conditions (such as snow, fog or rain) may contribute to or increase Hazards (e.g., by obscuring a Hazard), Workers shall identify the hazardous areas, e.g., with flagging, marking or other appropriate means.

Where use of a traction control aid is not authorized or appropriate, workers, in consultation with their supervisor, shall identify alternative means of reducing, eliminating or controlling the Hazard, such as traction aids or grated walking surfaces.

Be aware of the potential for different hazards related to ice and/or snow. For instance, ice build-up or slippery conditions may be present under snow cover. Other hazards may also be present or hidden under ice or snow.

3.2 WALKWAYS, STAIRWAYS, EXITS, PLATFORMS, LANDINGS AND OPENINGS

Walkways shall be designated and kept clear of hazards, debris, snow and ice.

Stairways, landings and exits shall:

- Be equipped with a handrail if it has more than 4 risers or rises more than 0.75 meters (30 inches); or
- Comply with Applicable Legislation including building codes, whichever is more stringent.

All permanent floor, walkway, working platforms, vault, handrail and ground openings that present a fall hazard of over 1.3 m (4 ft.) shall be properly guarded and marked utilizing either a guard rail, safety net or personal fall protection system.

Exposed duct banks and conduit shall not be used as walkways.

Workers shall not walk or stand on exposed pipes.

Attention must be provided to outside work areas with uneven ground or matting. Tripping hazards must be addressed immediately as appropriate.

Building exits shall be marked and shall have emergency lighting where required by Applicable legislation.

3.3 SCAFFOLDS

Workers using scaffolds, swing stage scaffolds and non-mobile elevated work platforms shall use personal fall protection systems when working at heights greater than 1.2 m (4 ft.) without proper guardrails.

Workers shall not:

- Sit or climb on the edge of the swing stage, work cage or scaffold handrails;
- Use ladders, unsecured planks or other devices as a work platform; and
- Work on scaffolds covered with snow, ice or other slippery material except as necessary to remove such materials.

Workers shall:

- Check the scaffold inspection tag prior to use to ensure the scaffold is fit for the intended use; and
- Lift or lower larger articles from elevated locations by a hand line or a hoist.

Scaffolds shall:

- Be installed, inspected, maintained, and repaired in accordance with the manufacturers' specifications and applicable legislation;
- Be erected and dismantled under the supervision of a qualified worker, competent in their construction and use;
- Be erected plumb to ensure maximum structural capacity of the system;
- Have a maximum height of three times the minimum base width unless additional stabilizing supports are used;
- Have a qualified worker confirm that the scaffold is erected properly and attach an inspection tag (which includes the load rating) prior to allowing work to commence, and
- Use components and planking that are in good repair.

If the scaffold is higher than 15 m (50 ft.), it shall be designed by a professional engineer, and erected, used and maintained in accordance with the engineered design.

Workers who are involved in erecting, disassembling, moving, operating, repairing, maintaining, or inspecting a scaffold shall be trained to recognize any hazards associated with the work.

All Workers who perform work while on a scaffold shall be trained by a qualified worker to recognize the hazards associated with the type of scaffold being used and to understand the procedures to control or minimize those hazards.

When erecting and dismantling supported scaffolds, a qualified worker shall ensure that all fall protection requirements are met and that a safe means of access is provided.

Scaffold components shall meet all applicable legislation as well as the following requirements set out in this manual:

- Scaffold bases shall:
 - Be set on level and compacted soils or other solid surface (i.e. concrete);
 - Have base plates (preferably with screw jacks to allow for adjustment) and should rest centrally on sills as required by ground conditions;
 - Be capable of carrying, without dangerous settling, all loads that are likely to be imposed on them;
 - Have sills that are not constructed by joining smaller pieces of wood together;
 - Not have a smaller dimension than 1/3 of the height of the scaffold without outriggers;
 - Have outriggers on base plates, fastened at approximately 1/3 of the total height when required; and
 - Have bridging that is secured in place, when bridging is required.
- Scaffold supports and bracing shall:
 - Be securely fastened in accordance with manufacturers' specifications;
 - Have all structural members in place;
 - Have all cross braces in place;
 - Be tied or secured to a building or other structural supports if the height exceeds 3 times the smallest base dimension;
 - Increase the number of ties if Hoarding/enclosure is used in windy conditions or if there are other dynamic loads caused by the work being done on the scaffold; and
 - Have ties that are placed as the scaffold is being erected.
- Scaffold planking shall:
 - Be manufactured scaffold planks that are used, stored, inspected and maintained according to manufacturers' specifications; or solid sawn lumber planks that are rated as scaffold grade or better;
 - Be visually inspected before installation;
 - Shall be replaced if it does not pass visual inspection;

- Extend over the centerline of its support at least 6 inches (15 cm), unless cleated or otherwise restrained by hooks or equivalent means or as directed by manufacturer specifications; and
- Be secured to prevent movement in any direction.
- Scaffold platforms shall:
 - Be identified as light or heavy duty; and
 - Be fully planked between the front uprights and the guardrail system.
- Scaffold guardrails shall:
 - Be installed on all platforms above 1.2 m (4 ft.).
- Scaffold toe boards shall:
 - Be used on the outer edges and the ends if the height of the scaffold planking is greater than 2 m (6 ft.).
- Scaffold ladders shall:
 - Be installed as the scaffold is being built;
 - Shall extend 1 m (3 ft.) above the top of the scaffold platform and shall be secured at the top when using portable ladders; and
 - Portable ladders shall be secured at the bottom or tied to the scaffold at waist height and flagged.

Internal stairways or built-in ladders are required for scaffolds greater than 9.1 m (30 ft.) high.

Attachable vertical scaffold ladders exceeding 6.1 m (20 ft.) in height shall be equipped with one of the following:

- A safety cage that complies with Applicable Legislation;
- Proper Fall Protection; and
- Rest platforms.

Workers shall not climb braces or end frames.

Using equipment to hoist Workers to a work area is prohibited unless it is demonstrated that conventional means would be more hazardous, or that conventional means would not be possible because of the project's structural design or worksite conditions. (In this case conventional means refers to the erection, dismantling and/or use of means such as ladders, stairways, scaffolds, personnel hoists, aerial lifts or elevating work platforms.)

Swing stages or suspended scaffolds, work cage platforms and man baskets shall:

- Not exceed the manufacturer's rated working load;
- Have the manufacturer's platform load rating clearly labeled and visible to all workers;
- Be installed by a qualified worker;
- Have the rated capacity of rigging hardware (e.g., hooks, shackles, rings, bolts, slings, chains, wire ropes, splices) capable of supporting at least 10 times the maximum load to which it may be subjected; and
- Use wire rope suspension lines that are free of kinks, birdcaging, excessive wear, broken wires, flat spots and other defects.

When used for hoisting Workers, swing stage or suspended scaffolds, work cage platforms and man baskets shall be designed and certified by a professional engineer. A copy of the certification, equipment drawings, and the most recent inspection certificate shall be available upon the Company's request.

Swing stages require a redundant system for control (such as a deadman switch/pedal or tandem operation) and properly sized and secured hangers or stirrups.

For work cages, when it is not practicable to provide a separate personal fall arrest system using a vertical lifeline for each worker in the work cage, then there shall be a separate support attached between the work cage and the hoist line. The support shall be above the hook that is capable of holding the weight of the work cage and any potential contents.

3.4 NON-MOBILE ELEVATED WORK PLATFORMS

All non-mobile elevated work platforms shall be equipped with:

- Handrails;
- Midrails;
- Toeboards;
- Skid-resistant working surfaces; and
- Wire mesh from the top rail to the toeboard if required by the Hazard Assessment.

When swing stages and work cages are being used, emergency rescue procedures shall be documented in the fall protection plan or critical lift plan and communicated to all workers.

Unprotected temporary openings in floors or elevated work platforms shall:

- Be covered with plywood that is at least $\frac{3}{4}$ of an inch in thickness;
- Have secured coverings capable of supporting twice the maximum intended load;
- Only be removed to perform a particular task; and

- Be color coded or effectively marked with the word 'HOLE' or 'COVER' to effectively warn workers of the hazard.

Coverings shall be replaced immediately after the task is complete or as appropriate during the task if other Workers are present near the work area.

3.5 STORAGE AND LAYDOWN YARDS

Warehouse, lay-down and storage areas shall be designated as work areas where PPE is required.

Ensure all materials are stored in designated areas, and ensure layout and access is convenient for unloading and loading trucks and that there is sufficient clearance for safe movement of all necessary vehicles.

Storage requirements include:

- Metal containers with lids shall be kept at convenient locations, to facilitate effective waste disposal;
- Overhead clearance shall be posted wherever necessary;
- Overhead power lines shall be clearly identified;
- Lumber shall be stored free of protruding objects;
- With the exception of large tanks, all materials must be stored off of the ground on racks, skids, planks or other safe and appropriate materials;
- Stored material shall be stacked securely, to ensure prevention of tipping, sliding, collapse or other Hazards;
- Pipe shall be adequately blocked/chocked when stored shelving shall:
 - Be marked with weight limits;
 - Be secured;
 - Have determined inspection timeline requirements.
- All secured loads shall be assessed prior to the release of the securing mechanism; and
- Carefully assess the load to ensure the load has not shifted during transport.

All dangerous goods being transported shall meet regulatory requirements for TDG documentation and labelling.

3.5.1 PIPE HANDLING AND STORAGE

Workers shall be trained to safely handle and secure pipe and materials.

Follow these requirements:

- Ensure the appropriate lifting equipment is used, i.e., side booms, track-hoes equipped with vacuum devices and cranes;
- Ensure pipe and fittings are handled using only approved rigging equipment designed not to damage the load, i.e., Teflon or brass insert stringing pipe hooks (sorting hooks) and nylon slings;
- Whenever possible, place pipe or materials in a flat area or parallel with a slope, rather than across a slope;
- Secure pipe or materials from movement by blocking, cradling, or a combination of both, or use an approved alternative method (see Figure 1);
- Ensure pipe blocks have sufficient strength to hold the weight of the load;
- Secure pipe blocks to prevent loads from being removed or dislodged. Skids are considered to be secured if the weight of the pipe or barrel prevents the skid from being dislodged or removed (see Figure 1);
- Ensure cross timbers are placed approximately 1 m (3 ft.) from the ends of the pipe;
- Stand clear when cutting steel bands or wire that secures a load of pipe to a vehicle or rail car;
- Keep hands clear of pipe-ends when pipe is being butted together; and
- Use tag lines.

Ensure pipe that is being stored (e.g., in populated areas, or at road crossings) is equipped with end caps or secured to prevent unauthorized entry.

Cradling

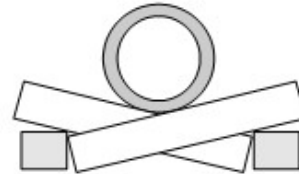
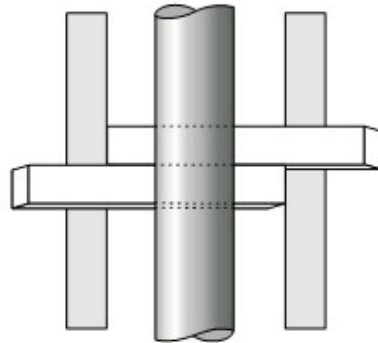

NOTE: Size or length of shaded blocks may vary based on soil conditions or slopes encountered. Skids cradling pipe are often staggered.

Cradling Pipe Above Ground

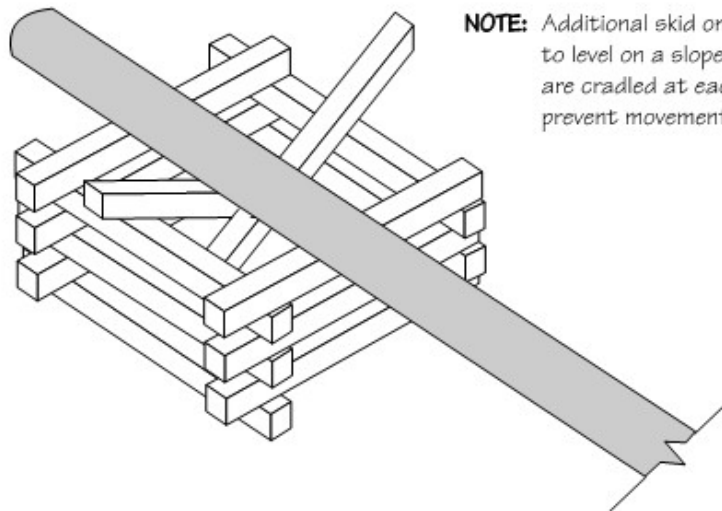

NOTE: Additional skid on left side to level on a slope. Pipes are cradled at each end to prevent movement.

Some Alternatives for Securing Pipe Blocks

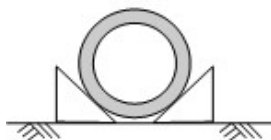

Secured by the Weight of the Pipe

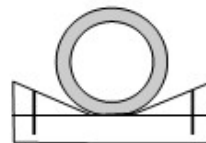

Secured to Skid

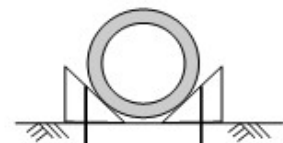

Pinned to Earth

Figure 1

4.0 REFERENCES

Occupational Safety and Health Administration (OSHA)

- Walking-Working Surfaces, Duty to have fall protection and falling object protection, 29 CFR 1910.29
- Scaffolds, 29 CFR 1926.451

Canada Labour Code Part II, Canadian Occupational Health & Safety Regulations,

- PART II Permanent Structures, 2.1 Division I Buildings
- 3.1 Temporary Structures & Excavations

<End of Document>